

Core & Main Supply **PLANT ESSENTIALS**

2024/2025

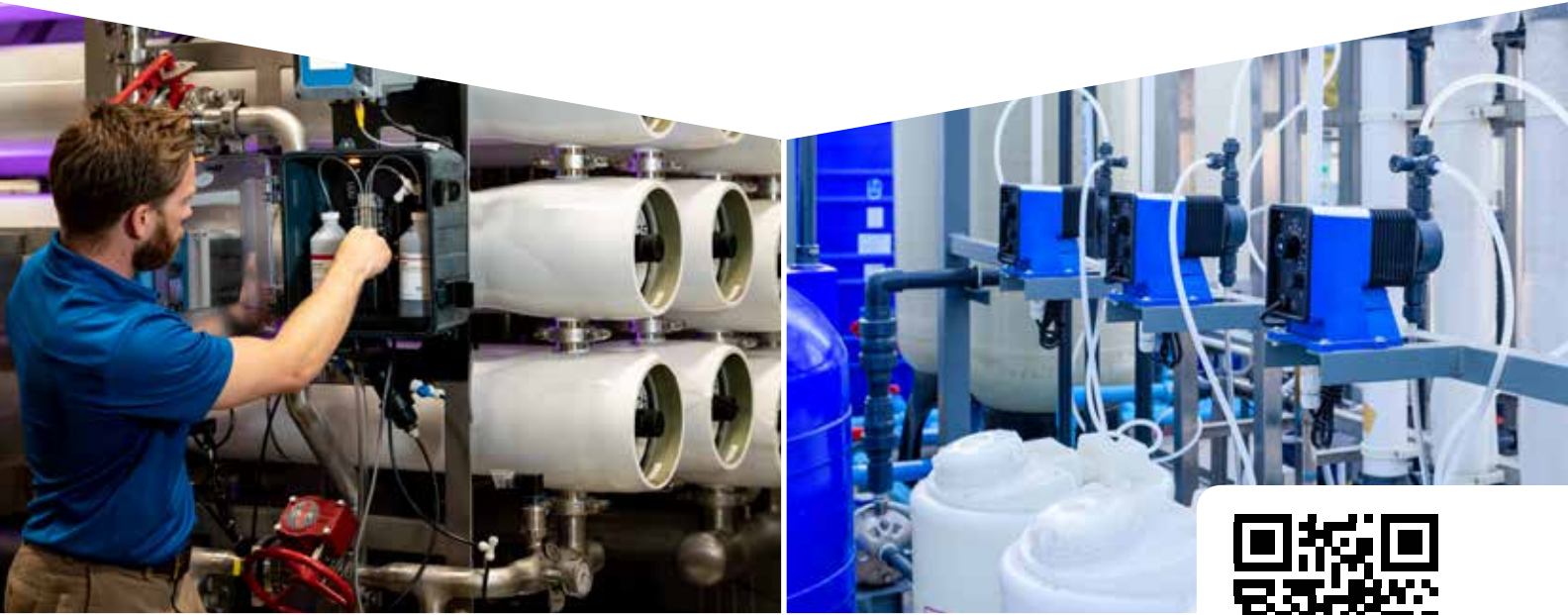

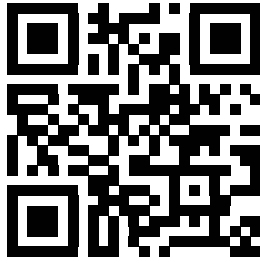

supply.coreandmain.com



The Products You Need, When You Need Them

As your trusted partner, Core & Main is always looking for ways to serve you better, including providing convenient access to the products you use in your day-to-day operations. This catalog contains a selection of durable, high-quality products from the leading brands in the industry.



Shop Online

For an even broader selection of items, shop our e-commerce site at supply.coreandmain.com where you'll find additional product information, documents and specifications.



Knowledgeable Staff

As you've come to expect from Core & Main, our knowledgeable staff are on hand to assist you with any questions you might have. Contact our team today at **1-888-885-2673** or at support.supply@coreandmain.com to place an order or for technical assistance. Our customer service representatives are ready to answer your questions from 6 a.m. to 7 p.m. CST, Monday - Friday.



1-888-885-2673

supply.coreandmain.com



TABLE OF CONTENTS

Aeration **7-12**

Blower Filters	8
Blower Lubricants	9
Blowers	9
Fine Bubble Diffusers	10
Surface Aerators	11
Submersible Mixers	12
Submersible Aspirating Mixers	12

Bio-Augmentation & Process Chemicals **13-18**

Dechlorination	14
Drain Cleaner	15
Drain Opener	15
FOG / Lift Station Maintenance	16
Grease & Odor Control	16-17
Polymer	17
Sewer / Sewage Treatment	17-18

Charts & Chart Recorders **19-24**

Chart Recorders	20-21
Chart Paper	22-23
Chart Pens	24

Chemical Feed **25-82**

Stenner S-Series Chemical Feed Pumps	26
Stenner Chemical Feed Pumps	27-32
Stenner Parts & Accessories	32-33
LMI Chemical Feed Pumps	34-42
LMI Parts & Accessories	43
Pulsafeeder Chemical Feed Pumps	44-50
Pulsafeeder Parts & Accessories	51
Chem-Tech Peristaltic Pumps	52
Grundfos Chemical Feed Pumps	53-54
Chemical Feed Metering Pumps	55
Chemical Feed Accessories	55
Skid Systems	56-57
Polymer Feed Systems	58-59
Scales	60
Tubing	61-63
Fittings	63-65
Injection Quills	66-67
Injection Quill Parts & Accessories	67
Calibration Columns	68
Static Mixers	68-69
Back Pressure Valves	69
Pressure Relief Valves	70
Utility Hand Pumps	70
Drum Pumps	71-72
Spill Containment	72-75
Ultraviolet Disinfection	76-80
Chlorinators	81
Chlorine Emergency Kits	82

Electrical **83-96**

Cable Protection Systems	84
Digital Panel Meters/Level Process Controllers	84-85
Generators & Power Inverters	86
Monitoring Systems	87-93
Testing Equipment	94-96



TABLE OF CONTENTS

Facilities 97-171

Duct Tape	98
Drum Handling Equipment	98-102
Ergonomic Solutions	103-107
Eyewash Stations & Showers	108-113
Facility Maintenance	114-116
Facility Protection	117
Fans & Dehumidifiers	118-127
Fire Extinguishers	127
Fork Truck Attachments	127-130
Grease & Lubricants	131-134
Industrial Ladders, Step Stands & Step Stools	135
Janitorial & Sanitary Supplies	136-137
Loading Dock Equipment	137-138
Material Handling	138-141
Overhead Lifting	141-153
Barrel Locks	154
Padlocks	155-156
Padlocks - Lockout	156-158
Paints & Painting Supplies	158-162
Graffiti Remover	162
Rust Converter	162
Asphalt Patch	163
Protective Barriers	163-167
Intermediate Bulk Containers	167
Hardware Kits	167
Spill Containment	168-169
Storage Solutions	170-171
Water Damage Restoration Equipment	171

Filtration 173-186

Bag Filters	174
Bag Filter Housings	175
Sediment Cartridges	176-179
Carbon Cartridges	180
High Flow Filter Cartridges	180-181
Plastic Filter Housings	182
Stainless Steel Filter Housings	183
High Flow Filter Housings	184-186

Flow Metering 187-202

Electromagnetic Flowmeters	188-190
Insertion Flow Meters, Mag	191-195
Insertion Flow Meters, Paddlewheel	196-197
Open Channel Flowmeters	198-199
Flowmeters	200-201
Water Meters & Accessories	202

Gauges 203-206

Standard Gauges	204
Industrial Gauges	204
Dry Process Gauges	205
Liquid Filled Process Gauges	205
Diaphragm Seal Gauges	206
Contractor Gauges	206
Gauge Accessories	206

Hose 207-216

Discharge Hose	208
Mill Hose	208
Suction Hose	209
Hose Kits	210
Hose Accessories	210-211
Garden Hose	211
Hose Repair	212
Hose Nozzles	213
Hose Coupling Accessories	213
Hose Couplings	214-216

Level & Pressure 217-242

Float Switches	218-223
Float Switch Accessories	224
Junction Boxes	224
High level Alarms	225
Submersible Transmitters	226-228
Submersible Transmitter Accessories	228
Lift Station Monitors	229
Electrical	229-230
Pump Control Panels	231-232
Pressure Switches	233
Pressure Transmitters	233-236
Ground Water Monitoring	237-242

Lighting 243-249

Area Lights	244
Flashlights	244-245
Headlamps	246-247
Lanterns	247
Lighting Part & Accessories	248
Penlights	248-249
Right Angle Lights	249

Pipe Accessories & Tools 251-260

Flange Packs	252
Lifting	252-253
Tapping	254-255
Cutters & Cutter Wheels	255
Power Cutters	256-257
Diamond Blades	258-259
Valve Operators	259-260

Process Analyzers 261-280

Chlorine Analyzers & Accessories	262-267
Conductivity	268
Controllers	269-271
Fluoride	272
Hardness/pH	273
pH/ORP Analyzers & Accessories	274-275
Turbidimeters & Accessories	276-277
Dissolved Oxygen	278
Field Testing Meters	279-280

Pumps 281-306

Utility Pumps	282
Submersible Dewatering/Utility Pumps	282-284
Submersible Sump Pumps	285-286
Pump Accessories	286
Effluent Pumps	287-289
Sewage Pumps	289-293
Grinder Pumps	293-295
Pump Control Panels	296-297
Trash Pumps	298-302
Diaphragm Pumps	303
Drum Pumps	304-305
Hydrostatic Test Pumps	305
Centrifugal Pumps	306

Safety 307-373

Gas Detection	308
Confined Space & Fall Protection - Harnesses and Lanyards	309-311
Confined Space & Fall Protection - Tripods, Hoists and Winches	312-316
Safety Blowers & Ventilation	317-319
Eye Protection - Face Shields	320
Eye Protection	321-326
Eyewash Stations & Showers	327-331
Eyewash Stations & Showers Accessories	332
First Aid - First Aid Kits	333-334
Hand Protection	334-341
Hand Protection - Coated Gloves	342-343
Hand Protection - Cut-Resistant Gloves	343-347
Hand Protection - Leather & Cotton Gloves	348
Hand Protection - Waterproof / Cold Weather Gloves	349-350
Head Protection - Hard Hats and Safety Helmets	351-353
Head Protection - Head and Neck Cooling/Warmers	353-354
Hearing Protection - Earmuffs	354
Hearing Protection - Earplugs	355
Heat Stress Protection - Cooling Towels	356
Heat Stress Kits	356
Coolers	356-357
Heat Stress Protection - Sqwincher	357
Respiratory Protection	358-361
Safety Apparel - Chemical Resistant	362
Safety Apparel - Hi-Vis Apparel	362-371
Safety Apparel - Raingear	371-372
Safety Apparel - Waders	372
Safety Apparel - Work Boots	373

Sampling Equipment 375-384

Hach Samplers & Accessories	376-378
Hach Sampler Parts & Accessories	379
Sludge Samplers	379-380
Sludge, Septic & Grease Samplers	380
Sludge Blanket Detectors	381
Dippers & Grab Samplers	382
Sampling Bags	383
Filter Bed Samplers	383
Sampling Stations	384

TABLE OF CONTENTS

Signs, Tags & Labels 385-414

Decals & Labels	386-388
Flow Arrow Tapes	388
Marking Tape	388-391
Pipe Markers	392-395
Posts & Hardware	396
Safety Signs	397-409
Safety Tags	410-414

Tanks 415-420

Dual Containment Tanks	416-417
Process Chemical Tanks	418
Chemical Feed Tanks	419
Chemical Solution Tanks	419

Tools 421-468

Chisels & Punches	422
Hammers & Mallets	423
Levels	424
Tape Measures	424
Pipe Tools/Vises	425
Pliers	425-428
Power Tools & Accessories	428-448
Drill Bits	448-450
Grinding Wheels & Discs	451
Hole Saw Sets	451
Saws & Saw Blades	452-453
Wire Brushes	454
Scrapers & Utility Knives	454-455
Screwdrivers	456-457
Screwdriver Sets	458
Sockets & Socket Accessories	459
Tool Sets	460
Tool Storage	460-462
Wrenches	463-468

Valves 469-476

Solenoid Valves	470
PVC Ball Valves	471-472
CPVC Ball Valves	472-473
Check Valves	474-475
Gate Valves	476

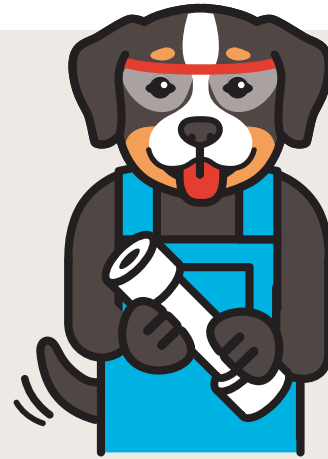

Hi! I'm Piper! I'm here to give helpful advice AND help ensure you have everything you need in the treatment plant and field!



Helpful Tips

Find me throughout the catalog and get ready to learn! I'll be barking up the right tree and ensuring you've got the knowledge you need to make informed decisions about products and accessories. My tips highlight different products, parameters, and processes throughout your plant!



NEED MORE?

Grab a FREE Lab and Field Catalog!

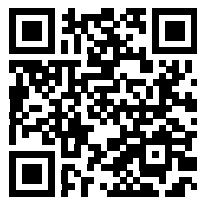

Scan the QR code with your phone to get additional catalogs with even more products from the brands you trust!

Core & Main Supply's Lab & Field Essentials catalogs pack more of the high-quality products you need, along with resources and tips throughout. Keep everything your operation needs in the lab, plant, and field right at your fingertips, 24/7!

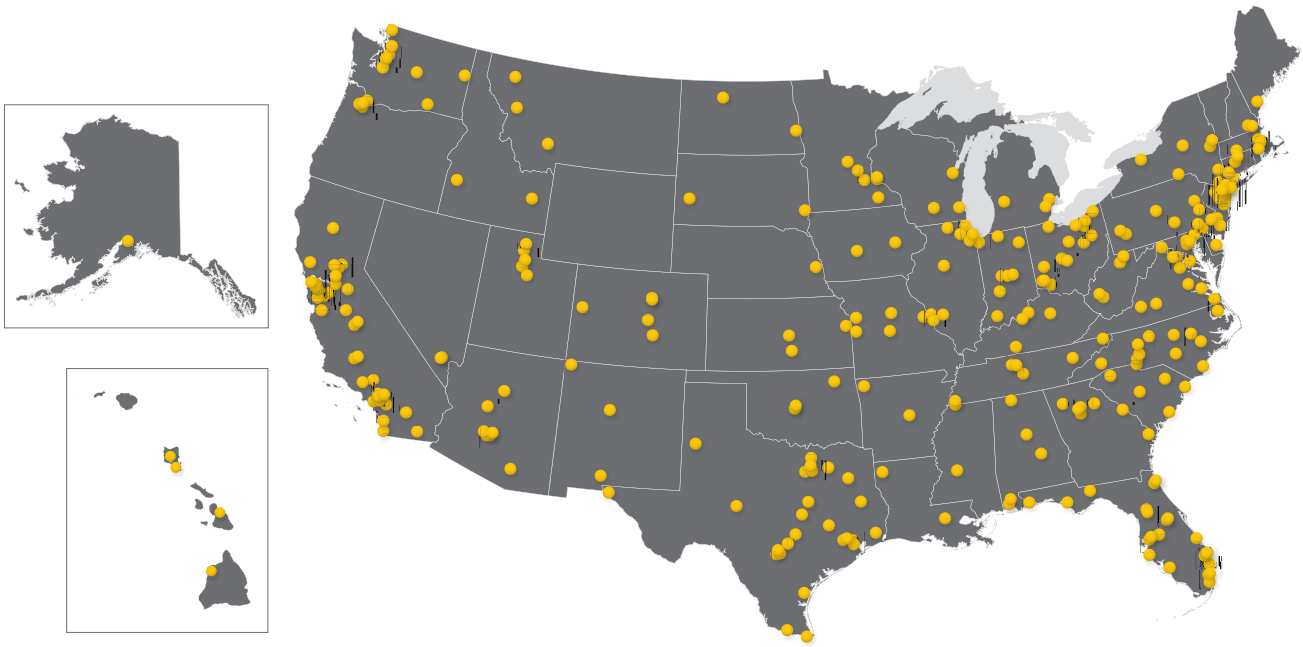

Local Knowledge
Local Experience
Local Service, Nationwide®

Every day, across the nation, our local branches demonstrate our commitment to water and wastewater professionals. Count on Core & Main to provide a quality product assortment from trusted brands, access to industry and product experts, and best-in-class service. **We're in your corner and around the corner.**

A Leading Specialized Distributor of Water, Wastewater and Storm Drainage Products, and Related Services

Aeration



TABLE OF CONTENTS

Blower Filters	8
Blower Lubricants	9
Blowers	9
Fine Bubble Diffusers	10
Surface Aerators	11
Submersible Mixers	12
Submersible Aspirating Mixers	12

Blower Filters

Blower filter elements remove particles such as dust, dirt, pollen, and other airborne debris, ensuring clean and filtered air is supplied to the blower or ventilation system. They are typically made of materials like paper, synthetic fibers, or a combination of both. They are engineered to have a high filtration efficiency while maintaining low airflow resistance, allowing for adequate airflow while effectively capturing particles.

These filter elements are available in various shapes and sizes to fit different blower systems and applications. They are often designed to be easily replaceable, allowing for regular maintenance and ensuring optimal performance of the blower system.



C&M PART #	MFG PART #	DESCRIPTION
A PAPER FILTERS		
40032801	RA-18	Filter Element Replacement for Solberg 18
40032802	RA-30	Filter Element Replacement for Solberg 30
40032803	RA-230	Filter Element Replacement for Solberg 230
40032804	RA-34	Filter Element Replacement for Solberg 34
40032805	RA-234	Filter Element Replacement for Solberg 234
40032806	RA-334	Filter Element Replacement for Solberg 334
40032807	RA-244	Filter Element Replacement for Solberg 244
40032808	RA-344	Filter Element Replacement for Solberg 344
40032809	RA-274	Filter Element Replacement for Solberg 274
40032810	RA-374	Filter Element Replacement for Solberg 374
40033801	RA-18P	Filter Element with Prefilter Replacement for Solberg 18P
40033802	RA-30P	Filter Element with Prefilter Replacement for Solberg 30P
40033803	RA-230P	Filter Element with Prefilter Replacement for Solberg 230P
40033804	RA-34P	Filter Element with Prefilter Replacement for Solberg 34P
40033805	RA-234P	Filter Element with Prefilter Replacement for Solberg 234P
40033806	RA-334P	Filter Element with Prefilter Replacement for Solberg 334P
40033807	RA-244P	Filter Element with Prefilter Replacement for Solberg 244P
40033808	RA-344P	Filter Element with Prefilter Replacement for Solberg 344P
40033809	RA-274P	Filter Element with Prefilter Replacement for Solberg 274P
40033810	RA-374P	Filter Element with Prefilter Replacement for Solberg 374P
40036620	RA-81-0470	Filter Element Replacement for Universal 81-0470
40036621	RA-81-0471	Filter Element Replacement for Universal 81-0471
40036622	RA-81-0472	Filter Element Replacement for Universal 81-0472
40036623	RA-81-1063	Filter Element Replacement for Universal 81-1063
40036624	RA-81-0474	Filter Element Replacement for Universal 81-0474
40036625	RA-81-0475	Filter Element Replacement for Universal 81-0475
40036626	RA-81-1163	Filter Element Replacement for Universal 81-1163
40036627	RA-81-1164	Filter Element Replacement for Universal 81-1164
400388	RA-81-0317	Polish Filter for FRH & FCRH Replacement for Universal P5 & 81-0317
40038943	RA-81-0326	2 Micron Panel Filter Element Replacement for Universal 81-0326
400394	RA-1058A	Panel Filter Replacement for Burgess Manning 1058A-102 & 1058A-104
40039766	RA-51005	Filter (Cylindrical) Replacement for Endustra Tri-Vent® RA-51005
40039767	RA-51006	Filter (Cylindrical) Replacement for Endustra Tri-Vent® RA-51006
40039768	RA-51007	Filter (Cylindrical) Replacement for Endustra Tri-Vent® RA-51007
40039769	RA-51008	Filter (Cylindrical) Replacement for Endustra Tri-Vent® RA-51008
40040675	RA-45773	Filter (Conical) Replacement for Endustra Tri-Vent® RA-45773
40040676	RA-45774	Filter (Conical) Replacement for Endustra Tri-Vent® RA-45774
40040677	RA-45775	Filter (Conical) Replacement for Endustra Tri-Vent® RA-45775
40040678	RA-45776	Filter (Conical) Replacement for Endustra Tri-Vent® RA-45776
40040679	RA-45777	Filter (Conical) Replacement for Endustra Tri-Vent® RA-45777

C&M PART #	MFG PART #	DESCRIPTION
B POLYESTER & FELT FILTERS		
40034811	RA-19	Filter Element Replacement for Solberg 19
40034812	RA-31	Filter Element Replacement for Solberg 31
40034813	RA-231	Filter Element Replacement for Solberg 231
40034814	RA-35	Filter Element Replacement for Solberg 35
40034815	RA-235	Filter Element Replacement for Solberg 235
40034816	RA-335	Filter Element Replacement for Solberg 335
40034817	RA-245	Filter Element Replacement for Solberg 245
40034818	RA-345	Filter Element Replacement for Solberg 345
40034819	RA-275	Filter Element Replacement for Solberg 275
40035711	RA-19P	Filter Element Replacement for Solberg 19P
40035712	RA-31P	Filter Element Replacement for Solberg 31P
40035713	RA-231P	Filter Element Replacement for Solberg 231P
40035714	RA-35P	Filter Element Replacement for Solberg 35P
40035715	RA-235P	Filter Element Replacement for Solberg 235P
40035716	RA-335P	Filter Element Replacement for Solberg 335P
40035717	RA-245P	Filter Element Replacement for Solberg 245P
40035718	RA-345P	Filter Element Replacement for Solberg 345P
40035719	RA-275P	Filter Element Replacement for Solberg 275P
40037428	RA-81-1201	Poly Felt Filter Element Replacement for Universal 81-1201
40037429	RA-81-1203	Poly Felt Filter Element Replacement for Universal 81-1203
40037430	RA-81-1204	Poly Felt Filter Element Replacement for Universal 81-1204
40037431	RA-81-1205	Poly Felt Filter Element Replacement for Universal 81-1205
40037432	RA-81-1206	Poly Felt Filter Element Replacement for Universal 81-1206
40037433	RA-81-1207	Poly Felt Filter Element Replacement for Universal 81-1207
40037434	RA-81-1209	Poly Felt Filter Element Replacement for Universal 81-1209
40038944	RA-81-0172	10 Micron Panel Filter Element Replacement for Universal 81-0172
40038945	RA-81-0173	10 Micron Panel Filter Element Replacement for Universal 81-0173
40040170	RPS-51005	Filter (Cylindrical) Replacement for Endustra Tri-Vent RPS-51005
40040171	RPS-51006	Filter (Cylindrical), Replacement for Endustra Tri-Vent RPS-51006
40040172	RPS-51007	Filter (Cylindrical), Replacement for Endustra Tri-Vent RPS-51007
40040473	RA-2424-05	Filter (Panel Style), Replacement for Endustra Tri-Vent RA-2424-05
40040474	RA-2424-WSRM	Filter (Panel Style), Replacement for Endustra Tri-Vent RA-2424-WSRM
40041180	RPS-47933	Filter Element (Conical), Replacement for Endustra Tri-Vent RPS-47933
40041181	RPS-47934	Filter Element (Conical), Replacement for Endustra Tri-Vent RPS-47934
40041182	RPS-47935	Filter Element (Conical), Replacement for Endustra Tri-Vent RPS-47935
40041183	RPS-47936	Filter Element (Conical), Replacement for Endustra Tri-Vent RPS-47936
40041184	RPS-47937	Filter Element (Conical), Replacement for Endustra Tri-Vent RPS-47937

Continued on Next Page

Blower Filters (continued)

C&M PART #	MFG PART #	DESCRIPTION
C WIRE MESH FILTERS		
40038135	RA-81-1035	Replacement Filter for Universal 81-1035
40038136	RA-81-1036	Replacement Filter for Universal 81-1036
40038137	RA-81-1037	Replacement Filter for Universal 81-1037
40038138	RA-81-1038	Replacement Filter for Universal 81-1038
40038139	RA-81-1039	Replacement Filter for Universal 81-1039
40038140	RA-81-1040	Replacement Filter for Universal 81-1040
40038141	RA-81-1200	Replacement Filter for Universal 81-1200
40039246	RA-81-0164	10 Micron Panel Replacement Filter for Universal 81-0164
40039247	RA-81-0165	10 Micron Panel Replacement Filter for Universal 81-0165
400395	RA-1058A-101	Panel Replacement Filter for Burgess Manning 1058A-101
400396	RA-1058A-103	Panel Replacement Filter for Burgess Manning 1058A-103

Republic Manufacturing Blower Lubricants

Blower lubricants play a crucial role in maintaining the proper functioning and longevity of blowers used in various industrial applications. Blowers are commonly used for processes such as pneumatic conveying, aeration, and ventilation. Lubricants used in blowers help reduce friction, dissipate heat, and prevent wear and tear on moving parts.



C&M PART #	MFG PART #	DESCRIPTION	PUMP/BLOWER	RATED TEMP	QTY
400001	99100QT	5 Star Vac Lube ISO 100	Vacuum	0 to 32°F	1 Quart
400002	99100QT-FG	5 Star Vac Lube ISO 100 Food Grade	Vacuum	0 to 32°F	1 Quart
400003	99100-5GAL	5 Star Vac Lube ISO 100	Vacuum	0 to 32°F	5 Gallons
400004	99100-5GAL-FG	5 Star Vac Lube ISO 100 Food Grade	Vacuum	0 to 32°F	5 Gallons
400005	99150QT	5 Star Super Lube ISO 150	Displacement	32 to 90°F	1 Quart
400006	99150GAL	5 Star Super Lube ISO 150	Displacement	32 to 90°F	1 Gallon
400007	99150-5GAL	5 Star Super Lube ISO 150	Displacement	32 to 90°F	5 Gallons
400008	99220QT	5 Star Super Lube ISO 220	Displacement	32 to 90°F	1 Quart
400009	99220GAL	5 Star Super Lube ISO 220	Displacement	32 to 90°F	1 Gallon
400010	99220-5GAL	5 Star Super Lube ISO 220	Displacement	32 to 90°F	5 Gallons
400011	99320QT	5 Star Super Lube ISO 320	Displacement	+90°F	1 Quart
400012	99320GAL	5 Star Super Lube ISO 320	Displacement	+90°F	1 Gallon
400013	99320-5GAL	5 Star Super Lube ISO 320	Displacement	+90°F	5 Gallons

Roots Blowers



Core & Main can provide you with all your Roots blower needs. The most popular positive displacement blowers include URAI and RAM Rotary blowers.

URAI Rotary Blowers

The URAI rotary blower is known for its heavy-duty design including a rigid cast iron casing, anti-friction bearings and two figure-eight love impellers.

RAM Rotary Blowers

The RAM rotary blowers include a heavy-duty design with integral-shaft ductile iron impellers. These designs provide lower installation costs and easier maintenance.

Please call Core & Main Supply at 1-888-885-2673 to talk with our Product Specialist Team about available options and pricing.



Helpful Tip: Blower Selection

Are you trying to decide on the right blower to use? Answer these questions and we can direct you to the blower that's right for your operations!

- What pressure are you needing for this project in PSI A or G?
 - How deep is the influent or water we are aerating?
 - Do you want a violent, medium or low flow at the aeration point?
- What flows in ACFM is needed for the project?
- What is the distance (ft) or run from blower to process?
- What diameter piping do you plan to use to get the air to the process?
- How many hours a day will the blowers be running?
- What is the ambient temperature in the room where the blowers will be running?
- What is the inlet temperature of the air for the blower?
- What is the elevation or inlet pressure where the project will be running?
- Is the area where the blowers will be running a classified area? (TEFC or XP)
- Is 3-phase power available on site?
- Is this a new application or an existing blower project?
 - If existing, what blower has been running to date?

EDI FlexAir™ T-Series Fine Bubble Tube Diffusers



The FlexAir T-Series Diffusers contain a fine pore, flexible membrane that provides a high level of oxygen transfer efficiency with maximum operating flexibility. These diffusers require minimum maintenance for long-term performance and a triple-check valve system that removes the intrusion of water and solids into the unit. Standard diffuser membranes are available in EPDM and PU held in place by 304 SS clamps.

FEATURES & BENEFITS

- Cost effective
- Easy to install
- Designed for coarse and fine bubble diffuser upgrades

INCLUDES

3/4" stainless steel nipples

C&M PART #	MFG PART #	MATERIAL	DIAMETER	LENGTH
401654X1FH	00249	Polyurethane	2.44"	24"
401654X1SV	00250	EPDM	2.44"	24"
4016546FFH	00251	Polyurethane	2.44"	25.6"
4016546FSV	00252	EPDM	2.44"	25.6"
401654Z1FH	01202	Polyurethane	2.44"	30"
401654Z1SV	01026	EPDM	2.44"	30"
401654SHFH	01030	Polyurethane	2.44"	39.5"
401654SHSV	01029	EPDM	2.44"	39.5"
4016556GFH	00253	Polyurethane	3.58"	19.8"
4016556GSV	00256	EPDM	3.58"	19.8"
401655Z1FH	00259	Polyurethane	3.58"	30"
401655Z1SV	00262	EPDM	3.58"	30"
401655SHFH	00265	Polyurethane	3.58"	39.5"
401655SHSV	00268	EPDM	3.58"	39.5"



Helpful Tip: Types of Bubbles

Fine Bubbles

These bubbles are distributed into the water at less with less than 2 mm bubble diameter. Fine bubbles are great for oxygen transfer efficiency.

Coarse Bubbles

These bubbles are distributed into the water at more than 2 mm bubble diameter. Coarse bubbles are great for mixing higher suspended solids content.

EDI FlexAir™ 9" and 12" Disc Fine Bubble Diffusers



The FlexAir Disc Diffusers contain a flexible membrane that provides operational flexibility with maximum oxygen transfer efficiency. Glass-filled polypropylene material withstands chemicals, high temperatures, and UV. Install disc diffusers with any 3/4" pipe fitting or pipe nipple. Select from two types of diffusers—micro diffusers provide traditional fine bubble efficiency; high-capacity diffusers are great for high airflow applications.

FEATURES & BENEFITS

- Cost effective
- Easy to install
- Rugged heavy-duty construction
- Pre-assembled

C&M PART #	MFG PART #	DIAMETER
MICRO		
4016566D	01798	9"
4016576D	06078	12"
HIGH-CAPACITY		
4016566E	01799	9"
4016576E	06080	12"

WE'D LIKE YOUR FEEDBACK

on our catalog and website



Send us your thoughts at
support.supply@coreandmain.com

Kasco Surface Aerators

Use the Surface Aerators to introduce oxygen to ponds, tanks and lagoons to prevent stratification, odor and algae growth, providing a thoroughly mixed and healthy pond or lake environment. These self-contained units can deliver up to 3 lbs of O₂ per horsepower per hour of operations.

Options with Control Panels and Bottom Screen Vertical Bars also available!

FEATURES & BENEFITS

- Design allows for low power consumption and low total cost
- Built with long lasting internal components
- Stainless Steel allows reliable performance in harsh environments

INCLUDES

Motor unit, float and mounting hardware and power cord



CERTIFICATIONS

- Meets UL and CSA Safety Standards

C&M PART #				MFG PART #	HP	VOLTAGE	PHASES	POND/LAGOON SIZE
50-FT L CORD	100-FT L CORD	150-FT L CORD	200-FT L CORD					
40166331	401663DG	40166301	401663EM	2400AF	1/2	120	1	3/4 Acre
40166431	401664DG	40166401	401664EM	3400AF	3/4	120	1	3/4 Acre
40166531	401665DG	40166501	401665EM	3400HAF	3/4	240	1	3/4 Acre
40166631	401666DG	40166601	401666EM	4400AF	1	120	1	1 Acre
40166731	401667DG	40166701	401667EM	U2.3AF	2	240	3	2 Acre
40166831	401668DG	40166801	401668EM	3.1AF	3	240	1	3 Acre
40166931	401669DG	40166901	401669EM	3.3AF	3	240	3	3 Acre
40167031	401670DG	40167001	401670EM	U3.3AF	3	240	3	3 Acre
—	401671DG	40167101	401671EM	U5.5AF	5	240	3	5 Acre

Air-O-Lator Aquarian Pro Floating Aerators



The Aquarian Pro floating aerators have high-velocity propellers that pump a water column creating the best possible oxygen transfer rate. This causes a shearing effect which converts the water column into a highly accelerated spray pattern that obtains oxygen. Mixing and aeration occurs with the simultaneous volume of water being propelled into the atmosphere.

FEATURES & BENEFITS

- Eco-friendly motor (no oil required)
- High-speed, foul resistant propeller
- Continuous turnover prevents stratification to depths of up to 12 feet

SPECIFICATIONS

MOTOR	Rugged, Stainless Steel Franklin Electric submersible motor, UL778 recognized			
C&M PART #	HP	VOLTAGE	PHASES	GPM
401658OEOZ	1/2	115	1	500
401658OEPA	1/2	230	1	500
401658OFPA	3/4	230	3	500
401658OFFC	3/4	460	3	500
40165830PA	1	230	1	1475
401658OGPA	1-1/2	230	3	1475
401658OFFC	1-1/2	460	3	1475

Air-O-Lator Aquarian Quantum Floating Aerators



The Aquarian Quantum floating aerators create a large continuous air/water interface to transfer atmospheric oxygen to the liquid and keep the degradable solids in suspension by mixing the liquid contents. The Quantum diffuser redirects the water allowing the flow to be propelled through the air at a tremendous velocity, while oxygen is added at a substantial rate. The Quantum floating aerator has an all-season performance with 95% of the weight of the aerator beneath the liquid surface. This prevents the Quantum from capsizing due to ice or turbulence.

FEATURES & BENEFITS

- All season performance
- 48" square, 8" thick polypropylene flotation device offers superior stability
- Decreases pond muck
- Increases oxygen levels

C&M PART #	HP	VOLTAGE	PHASES	GPM	MIN OPERATING DEPTH
401659F9PA	5	230	1	3400	39"
401659FPFC	5	230/460	3	3400	39"
401659OMPA	7.5	230	1	3800	42"
401659OMFC	7.5	230/460	3	3800	42"
401659N8PA	10	230	1	5000	43"
401659N8FC	10	230/460	3	5000	43"
401659S2PA	15	230/460	3	6200	46"
401659S2FC	20	230/460	3	8300	50"

Air-O-Lator Submersible Mixers



These Submersible Mixers feature a heavy-duty design for mixing and aerating in wastewater applications. Separate bearings for the propeller are housed in the fairwater, allowing strain to be removed from the motor. All mixers include a 304 SS motor support and mount, allowing the maintenance of the mixer without entering the tank. These mixers are easy to install and maintain. Select from direct-drive and gear-drive mixers. Gear-drive mixers feature a planetary gear reducer which allows for a larger propeller operating at a reduced rpm, while providing high volume pumping and thrust.

INCLUDES

304SS Motor Support and Mount, Propeller

SPECIFICATIONS

CONSTRUCTION	Ductile-iron housing, 316 SS prop, 304 SS mounting support
SOLIDS HANDLING	Up to 6% total suspended solids
MOTOR	Baldor 3-phase continuous duty motor

CERTIFICATIONS

- Class F insulation, UL listed for Class 1, Group D, Division 1 explosion-proof motor

C&M PART #	HP	PROP DIAMETER	RPM	GPM
DIRECT DRIVE				
40166087	3	10	1740	2800
401660F9	5	10	1735	4000
401660OM	7.5	12	1740	4200
GEAR DIRECT				
401661F9	5	26	300	13,000
401661OM	7.5	30	300	15,000
401661N8	10	26	430	18,000
401661S2	15	30	430	21,000

Air-O-Lator Enterprise II Aspirating Mixers



The Enterprise II Aspirating Mixers offer a high-performance solution in wastewater applications resulting in improved efficiency and energy savings. The low-profile design allows the mixer to be used in tanks that have limited headspace. The aspirating mixer functions as an axial flow propeller pump with a scientifically designed pump volute. It continuously propels a substantial volume of water past the four patented multi-purpose vanes, significantly increasing the velocity of the propelled fluids.

FEATURES & BENEFITS

- No mechanical icing problems
- Blower adaptability for additional airflow
- 95% of unit weight below surface insuring stability

SPECIFICATIONS

CONSTRUCTION	Ductile-iron housing, 316 SS prop, 304 SS mounting support
SOLIDS HANDLING	Up to 6% total suspended solids
MOTOR	Baldor 3-phase continuous duty motor

C&M PART #	HP	PROP DIAMETER	RPM	GPM
40166287	3	10"	1740	1800
401662F9	5	10"	1735	3400
401662OM	7.5	12"	1740	3800



Helpful Tip: Mixer Questions

- What are the dimensions of the tank (length, width & depth)?
- What is the shape of the tank, (round, square, rectangular, or oval)?
- What is the construction of the tank (concrete or steel)?
- What is the maximum liquid level?
 - This information will provide total cubic feet of liquid to be mixed.
- Is the tank an open or covered tank?
 - If covered, what is the dimension of the hatch to install mixer?
- What is the percentage of total solids?
 - Typical will be 2 to 4 percent up to 6 percent.
- If existing, what is the guide rail (mast) dimensions?
 - Our mixers are designed to fit a 4" square guide rail.
- Is this a new application or an existing one?

Bio-Augmentation & Process Chemicals



TABLE OF CONTENTS

Dechlorination	14
Drain Cleaner	15
Drain Opener	15
FOG / Lift Station Maintenance	16
Grease & Odor Control	16-17
Polymer	17
Sewer / Sewage Treatment	17-18



Vita-D-Chlor™ Dechlorination Tablets



Vita-D-Chlor Tablets are best used for providing vitamin C dechlorination in potable water. The tablets rapidly neutralize both chlorine and chloramines without impacting dissolved oxygen levels. Tablet form makes these ideal for field applications.

FEATURES & BENEFITS

- Safe treatment for low chlorine levels
- Ideal for use with most hydrant flushing devices
- Environmentally friendly
- Slow dissolving requirements

SPECIFICATIONS

ACTIVE INGREDIENT	75% Ascorbic acid
-------------------	-------------------

C&M PART #	MFG PART #	QUANTITY
10498427	V325.50.06T	6 Tablets
10498426	V325.50.20T	5 lbs (Approx. 20 Tablets)
10498425	V325.50.40T	10 lbs (Approx. 40 Tablets)
10498424	V325.50.140T	35 lbs (Approx. 140 Tablets)

Norweco® Enviro-C® Dechlorination Tablets



Enviro-C utilizes vitamin C to neutralize chlorine and chloramines from water, wastewater, and process water applications. These easy-to-use, scientifically blended tablets make dechlorination process simple, safe and practical.

FEATURES & BENEFITS

- For use in all types of tablet feeders or diffusers
- 100% organic and 100% soluble
- No effect on dissolved oxygen
- Nontoxic to fish or other aquatic life

SPECIFICATIONS

ACTIVE INGREDIENTS	75% Ascorbic Acid
--------------------	-------------------

C&M PART #	MFG PART #	PACKAGE SIZE
10526426	5Enviro-C	5 lbs
10526425	10Enviro-C	10 lbs
10526424	35Enviro-C	35 lbs

Norweco® Bio-Neutralizer® Dechlorination Tablets



Bio-Neutralizer tablets are formulated to provide a cost effective and efficient way of removing free and combined chlorine from the effluent of wastewater treatment systems. Easy-to-use, scientifically blended tablets provide a consistent reduction or elimination of chlorine residual without significantly reducing dissolved oxygen.

FEATURES & BENEFITS

- Removes chlorine to nondetectable levels
- Consistent sulfite dose
- Environmentally safe
- No effects on dissolved oxygen levels

SPECIFICATIONS

ACTIVE INGREDIENT	35% Sodium Sulfite
-------------------	--------------------

C&M PART #	MFG PART #	PACKAGE SIZE
10526133	25BioNeutralizer	25 lbs
10526132	45BioNeutralizer	45 lbs

Norweco® Bio-Max® Dechlorination Tablets



Bio-Max tablets provide a source of concentrated sodium sulfite to remove free and combined chlorine from wastewater, potable water and process water instantly. These easy-to-use, environmentally safe, and low-cost tablets make dechlorination process simple, safe and practical.

FEATURES & BENEFITS

- For gravity and pressure rated tablet feeders
- Cost effective treatment for high flow applications
- No effect on dissolved oxygen or pH
- No mixing of chemicals or solutions

SPECIFICATIONS

ACTIVE INGREDIENT	92% Sodium Sulfite
-------------------	--------------------

C&M PART #	MFG PART #	PACKAGE SIZE
105260	48BioMax	48 lbs

Norweco® Nitro-Buster® Nitrifying Bacteria

Nitro-Buster is a specialized mixture of bacteria designed to perform nitrification of ammonia nitrogen in residential and commercial wastewater treatment plants. Completely safe and effective, use Nitro-Buster to boost nitrification for new systems requiring a quick start or for systems that fail to reduce ammonia.



FEATURES & BENEFITS

- Optimum temperature range 40 to 110°F
- Performs with a pH range of 6.5 to 8.5
- Nonhazardous and nontoxic

C&M PART #	MFG PART #	PACKAGE SIZE	QUANTITY
105263	Nitro-Buster	1 Gallon Bottle	Case of 4

Enviro-Caustic Drain Opener

The Enviro-Caustic Drain Opener is a fast-acting product that offers the performance of traditional caustic drain openers, but is biodegradable, odorless and nonflammable.

FEATURES & BENEFITS

- Thickened formula sinks and clings to the point of obstruction
- Improved formula is highly effective against fats, oils and other organic obstructions

CERTIFICATIONS

- NSF L1 Certified



C&M PART #	QUANTITY
105056	12 Quarts

Drain Opener

The Drain Opener is an odorless, liquid drain opener that dissolves and liquefies fats, oils, hair and other organic matter to keep drains open and free flowing. Apply weekly to use as a drain maintainer and keep drains free of blockage.

FEATURES & BENEFITS

- Fast-acting, odorless and convenient to use
- Heavier than water drain opener solution passes through water to open clogs



C&M PART #	QUANTITY
105057	12 Quarts

HYDRO HITCH HFF DECHLORINATING DIFFUSER



The Hydro Hitch HFF Dechlorinating Diffuser can neutralize up to 10 ppm chlorine on potable pressurized water systems.

For more information, visit our website at supply.coreandmain.com



**Core & Main Pure EZ Lift,
 Lift Station Degreaser**



This powerful soy-based Lift Station Degreaser contains 95% soy and 5% d-limonene to effectively cut down the grease. It dissolves heavy grease and fat accumulations on walls and creates odor absorbing barrier to control odors while leaving a pleasant citrus scent. This degreaser will not harm bacterial action in sewage treatment plants.

FEATURES & BENEFITS

- Floats on the surface so it will rise and fall with the level of the wastewater
- Color indication lets you know when more is needed
- High soy content allows for a longer shelf life
- 100% natural biodegradable formula

C&M PART #	MFG PART #	PACKAGE SIZE	QUANTITY
105038	7010041	1 Gallon Bottle	Pack of 4
105039	7010005	5 Gallon Pail	1 Each

**Core & Main Pure Lift Station Degreaser,
 100% d-Limonene**



Use this all-natural Degreaser to cover offensive odors and eliminate grease accumulation in lift stations. When water levels rise and fall, it coats all lift station surfaces and removes heavy grease deposits from station walls. Biodegradable formula will not disrupt biological treatment processes.

FEATURES & BENEFITS

- Contains 100% natural d-Limonene to dissolve greases and deposits
- Color indication lets you know when more is needed

C&M PART #	PACKAGE SIZE	QUANTITY
105040	1 Gallon Bottle	Pack of 4
105041	5 Gallon Pail	1 Each

**Core & Main d-Solv LS
 Floating Lift Station Degreaser**



An all-natural solution for covering odors and eliminating grease accumulation in lift stations, d-Solv LS Degreaser creates an odor barrier that leaves a pleasant lime scent. Biodegradable formula will not disrupt biological treatment processes.

FEATURES & BENEFITS

- Contains 100% natural dipentene to dissolve greases and deposits
- Color indication lets you know when more is needed
- VOC compliant in all 50 states

C&M PART #	PACKAGE SIZE	QUANTITY
105047	1 Gallon Bottle	Pack of 4
105048	5 Gallon Pail	1 Each

Jetfoam™ Degreaser



Compared to normal sewer jetting operations, Jetfoam Degreaser liquefies the grease, keeps it in suspension and prevents recoagulation. It contains industrial strength surfactants and emulsifiers so only one pass is needed to get a superior clean line.

FEATURES & BENEFITS

- Completely biodegradable
- Noncorrosive
- Environmentally friendly

C&M PART #	SCENT	PACKAGE QUANTITY
401672	Fresh	5 Gallon Pail
401675	Orange	5 Gallon Pail
401676	Lemon	5 Gallon Pail

EHC-33™ Grease Control Bacteria Cultures



Use the EHC-33, an industrial strength blend of bacteria strains, to aggressively look for, metabolize and consume FOG (fats, oils, and grease). It begins working the moment it enters the system to tackle the components that make up grease: proteins, fats, and carbohydrates.

FEATURES & BENEFITS

- Environmentally friendly
- Reduces line lockage and improves flow
- Packed in convenient, ready-to-use water soluble bags

C&M PART #	PACKAGE QUANTITY
401677	25 lb

Core & Main Bio Block Bacterial Blocks



The Bio Blocks Bacterial Blocks break down grease, fat and sludge buildup in grease traps and lift stations while reducing strong odors. These solid, bacteria-laden blocks slowly dissolve to provide continuous maintenance over 45 to 90 day period allowing for around the clock treatment of water, not just periodic dosage.

FEATURES & BENEFITS

- Greatly reduces labor time needed for dosage maintenance
- Eliminates need for metering pump - no initial or maintenance cost
- Automates wastewater system
- Ideal for use in wastewater treatment systems, including Lift Stations, Wet Wells, Ponds, Lagoons, Basins, Settling Tanks, Holding Tanks, and Digesters

C&M PART #	PACKAGE SIZE	QUANTITY
105035	2 lbs	Pack of 4
105036	5 lbs	Pack of 4
105037	30 lbs	1 Each

Core & Main Settling Agent Concentrate



Settling Agent Concentrate is a cationic polymer flocculent formulated for easy clarification of waste water in industrial waste streams and municipal waste water treatment facilities. It uses high molecular-weight polymers for the rapid settling of solids and suspended debris, which in turn helps to increase the capacity of waste-handling systems.

FEATURES & BENEFITS

- Reducing operating costs
- Nontoxic, biodegradable formula
- Ideal for use on Primary and Secondary Clarifiers, Clarifiers, Settling Ponds, Basins and Reservoirs

C&M PART #	PACKAGE SIZE	QUANTITY
401174	1 Gallon	Pack of 4
401175	5 Gallons	1 Each
401176	35 Gallons	1 Each
401177	55 Gallons	1 Each

Core & Main Digestase™ SDE 340 Sewage Digestant



The Digestase SDE 340 Sewage Digestant is a blend of special bacteria strains cultured to quickly and effectively digest and liquefy organic sewage without odors. Apply regularly to minimize unwanted bacteria that produce odors and noxious gas. Once systems are treated, BOD and COD reduce faster and more efficiently, allowing the system to treat higher volumes of waste and meet stringent effluent quality requirements.

FEATURES & BENEFITS

- Bacteria are in spore form for extended shelf life
- Contains vitamins to enhance bacterial growth

C&M PART #	PACKAGE SIZE
401187	25 lbs

Core & Main Sewer Anti-Foam Concentrate



Sewer Anti-Foam Concentrate contains special silicone defoaming agents for fast breakdown of foam due to detergents, surfactants, and organic materials in the water. Use this nonpolluting concentrate to prevent foam from being recreated regardless of pH levels. It reduces the surface tension of sewage water to levels too low to support formation of foam.

FEATURES & BENEFITS

- Creates low surface tension—cannot support formation of foam
- Drip into digesters or pour into waste streams prior to foam accumulation

C&M PART #	PACKAGE SIZE	QUANTITY
401188	1 Gallon	Pack of 4
401189	5 Gallons	1 Each
401190	35 Gallons	1 Each
401191	55 Gallons	1 Each

Core & Main Silt/Sand Flush



Use Silt/Sand Flush to break up and disperse all types of organic and inorganic deposits that collect in storm and sanitary sewers. It makes it easier to flush the deposits out to keep piping, wells, and basins clean and unobstructed.

FEATURES & BENEFITS

- Use with a regular cleaning and flushing program
- Specially designed for mud, dirt and silt

C&M PART #	PACKAGE SIZE	QUANTITY
401178	1 Gallon	Pack of 4
401179	5 Gallons	1 Each
401180	35 Gallons	1 Each
401181	55 Gallons	1 Each

Core & Main Sewer Sweetener Liquid Deodorizer



Sewer Sweetener liquid deodorizer was formulated to control obnoxious odors in sewage plants, lagoons, and other wastewater facilities. Simply inject undiluted solution into feed lines or spray or mist over the source of the odor.

FEATURES & BENEFITS

- Does not harm bacterial action
- Water-based formula contains no harmful solvents

C&M PART #	SCENT	PACKAGE SIZE	QUANTITY
105043	Lemon	1 Gallon	Pack of 4
105044	Lemon	5 Gallons	1 Each
105045	Cherry	1 Gallon	Pack of 4
105046	Cherry	5 Gallons	1 Each

Core & Main Sewer Tracing Dye



Use Sewer Tracing Dye for all types of engineering work on sewer systems. When added to water, this highly concentrated dye creates an intense fluorescent yellow/green color for maximum visibility.

FEATURES & BENEFITS

- Excellent for finding leaks and conducting time-flow studies
- Concentrated formula is nontoxic and biodegradable
- Can be used when there is no sun or in low light conditions

C&M PART #	PACKAGE SIZE	QUANTITY
401182	1 Gallon	Pack of 4
401183	5 Gallons	1 Each

Charts & Chart Recorders

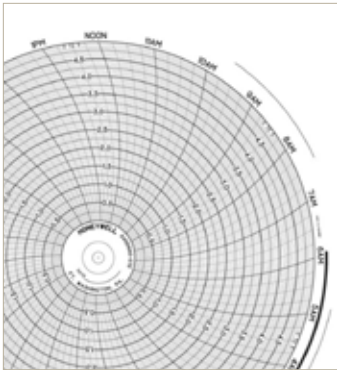

TABLE OF CONTENTS

Chart Recorders	20-21
Chart Paper	22-23
Chart Pens	24

Honeywell DR4300 Series Chart Recorders

These microprocessor-based DR4300 Chart Recorders accept various process signals from temperature, humidity, pressure and flow transmitters as well as T/C and RTD probes. The recorders provide reliable, pen-drawn analog traces on preprinted 10" charts that are easy to see and analyze. Easily set up and configure operating parameters to match



Honeywell

a wide range of applications such as environmental monitoring, flow, water and waste monitoring, and numerous other processes. Use DIP switches to configure basic recorder (no display). Models with display feature a vacuum fluorescent display/keypad with English language prompts for more advanced recorder set up and monitoring.

Each DR4300 recorder has built-in diagnostics that check critical recorder operations and provide error detection or messages to alert the user of potential faults. This self-test is run each time the recorder is powered up. Additionally, a built-in step pattern test can be run on demand to ensure proper pen and chart drive motor operation; this draws a special test pattern on the chart thus providing a record of the recorder's proper operation. Select from one- or two-pen model. Each pen channel has its own printed circuit assembly, allowing the channels to operate independently. A recorder is available with a totalizer for flow applications.

FEATURES & BENEFITS

- Use with 10" preprinted circular chart paper
- Fully user-configurable, no jumpers or rotary switches
- Built-in self test
- Easily configure chart speed and range

SPECIFICATIONS

CHART SIZE	10"
CHART SPEED	Basic: 8 hrs, 12 hrs, 24 hrs, 7 days Keypad: 1 hr to 744 hrs
RANGES	-999 to 9999
INPUTS	T/C, RTD, 0 to 20, 4 to 20 mA, 0 to 5, 1 to 5, 0 to 10 VDC, 0 to 10, 0 to 100, 0 to 200 mV
OPERATING CONDITIONS	32 to 131°F
POWER	100 to 240 VAC, 50/60 Hz
DIMENSIONS (W x H x D)	14" x 14" x 5.8" (Overall)
WEIGHT (lbs)	12
ENCLOSURE RATING	NEMA 3

C&M PART #	MFG PART #	DESCRIPTION
107294	DR4301-0000-G0100-0000-0000-00-000-00	One Pen, No Display
107295	DR4302-0000-G0100-0000-0000-00-000-00	Two Pens, No Display
107296	DR4311-0000-G0100-0000-0000-00-000-00	One Pen with Display
107297	DR4311-0000-G0100-00T0-0000-00-000-00	One Pen with Display and Totalizer
107298	DR4312-0000-G0100-0000-0000-00-000-00	Two Pens with Display

Honeywell DR4500 Classic Series Chart Recorders

The DR4500A Classic Series Chart Recorders combine the simplicity of pen drawn analog traces with the sophistication of microprocessor-controlled functions and is industrially hardened for use in the treatment plant. This combination results in a user-configurable recorder that is easily adapted to meet a variety of application requirements. All recorders feature a vacuum fluorescent display that continuously shows process variable values in the selected engineering units.



Honeywell

All models accept inputs from a variety of sensors or transmitters within the configurable range limits. Input ranges are easily expanded and compressed within their span limitations to meet specific measurement needs. Select to upscale or downscale sensor break protection for many of the actuators. Recorders with totalizer are available for flow applications. To totalize a variable, such as a flow signal, select the applicable input and set the digital display scaling factor through configuration. The totalizer has an eight-digit display.

Each DR4500A-series recorder includes self-diagnostic systems that check critical operations and provide error messages to alert users about detected faults. Power-up self-diagnostics is a microprocessor controlled diagnostic program that runs tests on selected circuitry when the recorder is powered up. A "key" test allows a user to initiate, on demand, a self-diagnostic routine that checks the keypad and front panel displays.

FEATURES & BENEFITS

- Easy set up—prompts and menu selection walk operator through the configuration process
- Standard 12" charts
- Bright, digital displays are easily read at a distance or in dim light
- Built-in 24 VDC power supply will drive up to 2 transmitters
- Continuously displays input process values

SPECIFICATIONS

CHART SIZE	12"
CHART DRIVE	Stepper Motor
RANGES	User Configurable
INPUTS	mA, VDC, T/C, RTD
OPERATING CONDITIONS	32 to 131°F
POWER	100 to 240 VAC, 50/60 Hz
DIMENSIONS (W x H x D)	14" x 16.5" x 5.6" (Overall)
WEIGHT (lbs)	13.2
ENCLOSURE RATING	NEMA 3
DIGITAL DISPLAY	Two row digital vacuum fluorescent, alphanumeric; 6-digit display dedicated to the process variable, 8-digit display shows key selected operating parameters and provides guidance during configuration

C&M PART #	MFG PART #	DESCRIPTION
107299	DR45A1-1000-00-000-0-000000-0	One Pen
107300	DR45A2-1100-00-000-0-000000-0	Two Pens
107301	DR45A1-1000-00-000-A-000000-0	One Pen with One Totalizer
107302	DR45A2-1100-00-000-E-000000-0	Two Pens with Two Totalizers

Honeywell DR4500 Truline® Series Chart Recorders

The microprocessor-based DR4500 Truline Recorders use a “one-pen” stylus printhead that produces analog traces and prints alphanumeric chart data on a blank heat-sensitive chart. These recorders use a dot fill technique from a microprocessor algorithm to produce a continuous analog trace of a process variable. All models accept inputs from a variety of sensors or transmitters within the configurable range limits.



Honeywell

By using a “one-pen” printhead that is capable of printing alphanumeric characters, users can now set various “printed” chart data through configuration. Easily personalize range marking in engineering units; digital values for process variables, and trace. This data, plus printed timelines and engineering units of scale eliminate the need to maintain an inventory of a variety of preprinted charts, saving you money. All DR4500A Series recorders include self-diagnostic systems that check critical operations and provide error messages to alert users about detected faults.

Recorders with totalizer are available for flow applications. To totalize a variable, such as a flow signal, select the applicable input and set the digital display scaling factor through configuration. The totalizer has an eight-digit display and 14-digit printing on the chart.

FEATURES & BENEFITS

- 12” thermal charts—eliminates the need for stocking multiple charts
- Clear, bright alphanumeric display
- Real time clock, dates, time of recording/printing
- Includes 24 VDC transmitter power supply

SPECIFICATIONS

CHART SIZE	12”
CHART DRIVE	Stepper Motor
RANGES	User Configurable
INPUTS	mA, VDC, T/C, RTD
OPERATING CONDITIONS	32 to 131°F
POWER:	100 to 240 VAC, 50/60 Hz
DIMENSIONS (W x H x D)	14” x 16.5” x 5.6” (overall)
WEIGHT (lbs)	13.2
ENCLOSURE RATING	NEMA 3
DIGITAL DISPLAY	Two row digital vacuum fluorescent, alphanumeric; 6-digit display dedicated to the process variable, 8-digit display shows key selected operating parameters and provides guidance during configuration

C&M PART #	MFG PART #	DESCRIPTION
107303	DR45AT-1000-00-000-0-000000-0	One Pen
107304	DR45AT-1000-00-000-A-000000-0	One Pen with One Totalizer
107305	DR45AT-1100-00-000-0-000000-0	Two Pens
107306	DR45AT-1100-00-000-E-000000-0	Two Pens with Two Totalizers

CHECK US OUT ONLINE

We're always adding new products.
Visit supply.coreandmain.com
for our latest additions.



Helpful Tip: Replacement Paper

Manufacturers make chart paper in many sizes, styles and configurations. Just because two charts have the same diameter, period and range does not mean they can both work on the same machine. Center hole sizing and shape as well as scaling differs between manufacturers and even between one manufacturer's different models. To ensure that you are ordering the correct chart paper for your chart recorder we recommend using the part number printed on the center of the chart recorder paper you have been using.

If you do not have the part number or cannot find the part number on our website, call us at **888-885-2673**. If you do not have the part number of the chart paper, please be prepared to provide the make and model of the chart recorder you are using, the range you require and the period of the chart.



Replacement Chart Paper

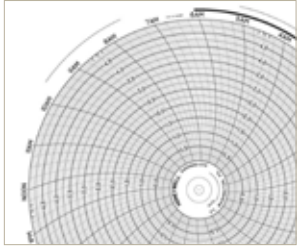

Popular replacement chart recording paper for major chart recorder brands are available below.

C&M PART #	EQUIVALENT TO	RANGE	SIZE	QTY/BOX
24-HOUR CIRCULAR CHART PAPER				
ABB Kent-Taylor				
107365OP01	500P1225-1	0 to 100	10-1/2"	100
Bristol				
10736707	18019	0 to 100	8"	100
10736708	4753	0 to 150	8"	100
10736709	4641	0 to 200	8"	100
1073700201	55000	0 to 10	11"	100
1073700501	55003	0 to 30	11"	100
107370SZ01	55004	0 to 40	11"	100
1073700601	55005	0 to 50	11"	100
107370TI01	55008	0 to 80	11"	100
1073700701	55010	0 to 100	11"	100
107370SH01	4639	0 to 125	11"	100
107370SK01	55533	0 to 1500	11"	100
Dickson				
10738507C101	C010	0 to 100	4"	60
107385SSI201	C660	0 to 250	6"	60
107385HGL101	C411	(-)50 to 50	8"	60
107385SIL101	C457	0 to 14	8"	60
10738507L101	C410	0 to 100	8"	60
10738508L101	C425	0 to 150	8"	60
10738509L101	C456	0 to 200	8"	60
107385SSL101	C432	0 to 250	8"	60
Eurotherm-Chessell				
107405TPN801	GDTW0394U100	No Range	10"	100
107405SLN801	HKTW0050S586	0 to 2	10"	100
107405STN801	HKTW0060S033	0 to 3	10"	100
10740501N801	HKTW0050S203	0 to 5	10"	100
10740502N801	HKTW0100S016	0 to 10	10"	100
107405SIN801	GDTW0070S132	0 to 14	10"	100
107405SQN801	HKTW0050S023	0 to 25	10"	100
10740505N801	HKTW0100S299	0 to 30	10"	100
10740506N801	GDTW0050U050	0 to 50	10"	100
10740530N801	GDTW0060U060	0 to 60	10"	100
10740507N801	GDTW0100U100	0 to 100	10"	100
107405SVN801	GDTW0100S027	0 to 300	10"	100
107405SEN801	HKTW0100S077	0 to 1000	10"	100
107405SNN801	HKTW0100S048	0 to 2000	10"	100
107405TFN801	HKTW0050S025	0 to 5000	10"	100

C&M PART #	EQUIVALENT TO	RANGE	SIZE	QTY/BOX
24-HOUR CIRCULAR CHART PAPER (CONTINUED)				
Fischer & Porter				
1074320101	216A020U08	0 to 5	10"	100
1074320701	216A001U01	0 to 100	10"	100
107432SG01	216A021U08	0 to 1200	10"	100
1074350301	211G008	0 to 15	12"	100
107435SQ01	211G010	0 to 25	12"	100
Foxboro				
107439SIP101	898914	0 to 14	11"	100
10743904P101	858050	0 to 20	11"	100
107439SZP101	898491	0 to 40	11"	100
107439SCP101	808417	0 to 100/0 to 150	11"	100
10743907P101	898413	0 to 100	11"	100
10743908P101	898423	0 to 150	11"	100
10743909P101	898442	0 to 200	11"	100
107439SSP101	898460	0 to 250	11"	100
107439TEP101	898439	0 to 500	11"	100
107439SVP101	898445	0 to 300	11"	100
107439SEP101	898494	0 to 1000	11"	100
107439SKP101	898689	0 to 1500	11"	100
Honeywell				
107454TBN801	24001660-072	0 to 5 (0.01)	10"	100
107454TCN801	24001660-074	0 to 5 (0.1)	10"	100
10745402N801	24001660-076	0 to 10	10"	100
107454SIN801	24001660-036	0 to 14	10"	100
10745403N801	24001660-119	0 to 15	10"	100
107454SQN801	24001660-095	0 to 25	10"	100
10745405N801	24001660-040	0 to 30	10"	100
10745407N803*	30755820	0 to 100	10"	25
10745408N801	24001660-180	0 to 150	10"	100
107454SIN801	24001660-070	0 to 150 Temp	10"	100
10745409N801	24001660-010	0 to 200	10"	100
107454TAN801	24001660-011	0 to 400	10"	100
107454TFN801	24001660-052	0 to 600	10"	100
107468SY01	15079	0 to 4	12"	100
107468SF01	16147	0 to 12	12"	100
1074680401	14305	0 to 20	12"	100
107468SE01	14204	0 to 1000	12"	100
107468TF01	14861	0 to 5000	12"	100

*This paper has 24-Hour timing on one side, 7-Day timing on the other side

Continued on Next Page

Replacement Chart Paper (continued)

C&M PART #	EQUIVALENT TO	RANGE	SIZE	QTY/BOX
24-HOUR CIRCULAR CHART PAPER (CONTINUED)				
Partlow				
1074890101	00214728	0 to 5	10"	100
1074890201	00214714	0 to 10	10"	100
107489SI01	00214417	0 to 14	10"	100
1074890701	00213825	0 to 100	10"	100
1074890901	00213801	0 to 200	10"	100
107489TA01	00213802	0 to 400	10"	100
107489TG01	00213817	0 to 600	10"	100
107489TJ01	00213803	0 to 800	10"	100
107489SK01	00213822	0 to 1500	10"	100
107489SN01	00213810	0 to 2000	10"	100
10749901	00215208	100 Rings	12"	100
7-DAY CIRCULAR CHART PAPER				
ABB Kent-Taylor				
107365N802	500P1225-2	0 to 100	10"	100
Bristol				
1073700502	55013	0 to 30	11"	100
107370SZ02	55115	0 to 40	11"	100
1073700602	55015	0 to 50	11"	100
1073703002	55106	0 to 60	11"	100
1073700702	55040	0 to 100	11"	100
1073700902	55167	0 to 200	11"	100
107370SV02	55129	0 to 300	11"	100
Dickson				
10738507C102	C012	0 to 100	4"	60
10738509C102	C040	0 to 200	4"	60
107385SVC102	C036	0 to 300	4"	60
107396HG	C651	(-)50 to 50	6"	60
10739607	C657	0 to 100	6"	60
107397SI	C453	0 to 14	8"	60
10739707	C412	0 to 100	8"	60
10739708	C435	0 to 150	8"	60
10739709	C436	0 to 200	8"	60
107397SS	C439	0 to 250	8"	60
107397SV	C431	0 to 300	8"	60
107397SE	C440	0 to 1000	8"	60
Eurotherm-Chessell				
107405SAN802	HKSV0100S078	0 to 1	10"	100
107405SLN802	HKSV0100S086	0 to 2	10"	100
10740501N802	HKSV0100S274	0 to 5	10"	100
107405SIN802	HKSV0070S083	0 to 14	10"	100
10740503N802	HKSV0050S049	0 to 15	10"	100
10740504N802	HKSV0100S246	0 to 20	10"	100
10740505N802	HKSV0060S288	0 to 30	10"	100
107405SXN802	HKSV0070S239	0 to 35	10"	100
10740506N802	GDSV0050U050	0 to 50	10"	100
10740507N802	GDSV0100U100	0 to 100	10"	100
107405TEN802	HKSV0100S319	0 to 500	10"	100

C&M PART #	EQUIVALENT TO	RANGE	SIZE	QTY/BOX
7-DAY CIRCULAR CHART PAPER (CONTINUED)				
Fischer & Porter				
1074320702	216A014U01	0 to 100	10"	100
1074350702	211H014	0 to 100	12"	100
Foxboro				
107439SAP102	809587	0 to 1	11"	100
10743907P102	899413	0 to 100	11"	100
107439SNP102	809592	0 to 2000	11"	100
Honeywell				
107454TKN802	24001661-217	0 to 2	10"	100
10745401N802	24001661-074	0 to 5	10"	100
1074545IN802	24001661-036	0 to 14	10"	100
10745404N802	24001661-071	0 to 20	10"	100
107454SQN802	24001661-095	0 to 25 Even	10"	100
10745405N802	24001661-040	0 to 30 Even	10"	100
107454SZN802	24001661-041	0 to 40 Even	10"	100
10745406N802	24001661-051	0 to 50 Even	10"	100
10745407N803*	30755820	0 to 100	10"	25
10745407N802	24001661-001	0 to 100	10"	100
10745409N802	24001661-004	0 to 200	10"	100
107454SNN802	24001661-014	0 to 2000	10"	100
1074680702	14479	0 to 100	12"	100
107468TK02	15186	100 to 0	12"	100
10747302	30755317-001-HW	Blank (Thermal)	12"	100
Partlow				
1074890102	00214729	0 to 5	10"	100
1074890202	00214754	0 to 10	10"	100
107489SI02	00214416	0 to 14	10"	100
1074890602	00214420	0 to 50	10"	100
1074890702	00213826	0 to 100	10"	100
1074890902	00213806	0 to 200	10"	100
107489SV02	00213884	0 to 300	10"	100
107489TA02	00213807	0 to 400	10"	100
107489TG02	00213818	0 to 600	10"	100
107489TJ02	00213808	0 to 800	10"	100
107489SE02	00213821	0 to 1000	10"	100
10749902	00215208	100 Rings	12"	100

*This paper has 24-Hour timing on one side, 7-Day timing on the other side



Helpful Tip: Nib Length

If ordering a universal pen, make sure to order the correct nib length. Nib length is measured from the base of the pen to the tip of the ink. Have questions about choosing a universal pen or having trouble finding the manufacturer specific pen you need? Call us at **888-885-2673**, we are happy to help!



Replacement Chart Pens



Choose from universal or manufacturer specific replacement chart pens. Universal chart pens include a snap on clip to adapt attachment to different manufacturers' flat or wire pen arms. These pens fit a variety of machines such as Honeywell, Martin Decker, DeWit and Barton.

Manufacturer specific replacement pens are made specifically for your recorder.

C&M PART #	MFG PART #	COLOR	NIB LENGTH
UNIVERSAL REPLACEMENT CHART PENS FOR CIRCULAR RECORDERS, PACK OF 6			
1081221723	82-39-0101-06	Black	0.14"
108122A723	82-39-0102-06	Red	0.14"
1081221923	82-39-0103-06	Blue	0.14"
1081226823	82-39-0104-06	Green	0.14"
1081229923	82-39-0106-06	Purple	0.14"
1081221725	82-39-0201-06	Black	0.37"
108122A725	82-39-0202-06	Red	0.37"
1081221925	82-39-0203-06	Blue	0.37"
1081226825	82-39-0204-06	Green	0.37"
1081229925	82-39-0206-06	Purple	0.37"
1081221726	82-39-0301-06	Black	0.60"
108122A726	82-39-0302-06	Red	0.60"
1081221926	82-39-0303-06	Blue	0.60"
1081226826	82-39-0304-06	Green	0.60"
1081229926	82-39-0306-06	Purple	0.60"
1081221727	82-39-0401-06	Black	0.83"
108122A727	82-39-0402-06	Red	0.83"
1081221927	82-39-0403-06	Blue	0.83"
1081226827	82-39-0404-06	Green	0.83"
1081229927	82-39-0406-06	Purple	0.83"
UNIVERSAL REPLACEMENT CHART PEN FOR STRIP RECORDERS, PACK OF 5			
108142	82-09-0202-05	Red	0.265"

C&M PART #	EQUIVALENT TO	COLOR
ABB CLEARSPAN P70M, PX105, PXR105 & P105M REPLACEMENT CHART PENS, PACK OF 5		
108143A7	P105M/0301 (F51581 02Z05)	Red
10814319	P105M/0303 (F51582 03Z05)	Blue
10814368	P105M/0302 (F51580 04Z05)	Green
ABB C1900, C1300, 500S & 155S REPLACEMENT CHART PENS, PACK OF 5		
10814617	C1900-0119	Black
108146A7	C1900-0121	Red
10814619	C1900-0120	Blue
10814668	C1900-0122	Green
10814699	C1900-0123	Purple
BADGER METER 2600, 2700 & 3000 REPLACEMENT CHART PENS, PACK OF 5		
108151	500724-0001 (82-09-0162-05)	Red
DICKSON ESX, ET6, EV4, PR4, PR8, PW4 & ET855 REPLACEMENT CHART PENS, PACK OF 6		
108152A7	P222 (82-60-0017-06)	Red
10815219	P226 (82-60-0023-06)	Blue
108152SG	P246 (P222+P226)	Red & Blue (3 ea)
EUROTHERM-CHESELL 390 & 392 REPLACEMENT CHART PENS, PACK OF 5		
10815517	LA 203294 (82-88-0401-05)	Black
108155A7	LA 203292 (82-88-0202-05)	Red
10815519	LA 203211 (82-88-0103-05)	Blue
10815568	LA 203293 (82-88-0304-05)	Green
FISCHER & PORTER 1390 & 1392 REPLACEMENT CHART PENS, PACK OF 5		
10815919	141D001U25 (82-88-0103-05)	Blue, Pen 1
108159A7	141D001U22 (82-88-0202-05)	Red, Pen 2
10815968	141D001U31 (82-88-0304-05)	Green, Pen 3
10815917	141D001U20 (82-88-0401-05)	Black, Pen 4
FOXBORO 740 REPLACEMENT CHART PENS, PACK OF 6		
108163A7	L0122AR	Red
10816319	L0122DB	Blue
10816399	L0122BP	Purple
PARTLOW ARC4100, MRC5000, 7000, 7800 & 8000 REPLACEMENT CHART PENS, PACK OF 5		
108166A7	60500402 (82-32-0322-05)	Red
10816668	60500401 (82-32-0314-05)	Green
PARTLOW VERSACHART CARTRIDGE REPLACEMENT CHART PENS, PACK OF 1		
108168SH	60500802	Green & Red (1 ea)
108168SI	60500803	Blue, Green & Red (1 ea)
108168SJ	60500804	Black, Blue, Green & Red (1 ea)
YOKOGAWA UR100, URS100X, UR250 & UR1000 REPLACEMENT CHART PENS, PACK OF 3		
108176A7	B9565AP	Red
10817619	B9565AR	Blue
10817668	B9565AQ	Green
10817699	B9565AS	Purple
YOKOGAWA UR1000, SR1000, 1800, UR2000 & SR10000 REPLACEMENT CHART PENS, PACK OF 3		
108171A7	B9902AM	Red
10817119	B9902AP	Blue
10817168	B9902AN	Green
10817199	B9902AR	Purple
108171AP	B9902AQ	Magenta

Chemical Feed



TABLE OF CONTENTS

Stenner S-Series Chemical Feed Pumps	26
Stenner Chemical Feed Pumps	27-32
Stenner Parts & Accessories	32-33
LMI Chemical Feed Pumps	34-42
LMI Parts & Accessories	43
Pulsafeeder Chemical Feed Pumps	44-50
Pulsafeeder Parts & Accessories	51
Chem-Tech Peristaltic Pumps	52
Grundfos Chemical Feed Pumps	53-54
Chemical Feed Metering Pumps	55
Chemical Feed Accessories	55
Skid Systems	56-57
Polymer Feed Systems	58-59
Scales	60
Tubing	61-63
Fittings	63-65
Injection Quills	66-67
Injection Quill Parts & Accessories	67
Calibration Columns	68
Static Mixers	68-69
Back Pressure Valves	69
Pressure Relief Valves	70
Utility Hand Pumps	70
Drum Pumps	71-72
Spill Containment	72-75
Ultraviolet Disinfection	76-80
Chlorinators	81
Chlorine Emergency Kits	82

Stenner S-Series Chemical Feed Pumps

The S Series Peristaltic Metering Pumps can interface with process control systems as they feature a 4 to 20 mA output signal, three output relays and is Modbus capable for use with your most demanding applications. The intuitive OLED operating display is easy to program and navigate. The indicator communicates the pump status activates either a display alarm, output alarm or both depending on the setting. In the event of a leak in the pump head, a tube icon appears notifying you of a leak.

Select from the nine modes of operation: 4 to 20 mA scalable, invertible; 0 to 10 VDC scalable, invertible; pulse; PPM feed flow switch; PPM feed hall effect; hall effect; manual; 7 Day/24 hour timer or cycle timer. Program the pumps using the digital keypad to respond based on a selected pump condition such as tube leak, standby, repeat pulse, run, mode change, low or high signal, low or high flow, drive fault, signal overrun, transfer and off. Standby input option to stop or start pump remotely.

A robust NEMA 4X rated enclosure protects the pump from corrosion and extreme environments. Brushless DC motor with ball bearing supports provides long service life. Password protection prevents unauthorized access to the programmed settings. Program the transfer function to activate a relay to start a second S Series as a backup to the primary pump.

FEATURES & BENEFITS

- Self-priming against maximum working pressure
- Can pump off-gassing solutions
- No vapor lock or loss of prime
- Simple tube replacement
- Three-point roller design assists with anti-siphoning
- Output volume not affected by back pressure
- Foot, prime or degassing valve not required
- Three dedicated output relays (Leak Detect, Run and Transfer)
- 4 to 20 mA output signal and Modbus capable
- Durable NEMA 4X rated enclosure

WETTED MATERIALS

Santoprene® pump tube & duckbill; PVC or Polypropylene tube fittings, injection fittings, suction line strainer connecting nuts & adapters; Polyethylene ferrules & suction/discharge tubing; Hastelloy® leak detect components; tantalum & FKM or Stainless steel, EPDM & Santoprene® ball check valve components

INCLUDES

S30 Models: (3) connecting nuts 1/4" & (3) ferrules 1/4", or (3) connecting nuts 3/8" & (2) adapters 3/8"; (1) injection fitting (25 PSI) or (1) duckbill check valve (100 PSI); (1) weighted suction line strainer; 20-ft roll suction/discharge tubing; (1) additional pump tube; (2) additional latches; (1) mounting bracket; (1) quick start guide

S40, S50 Models: (3) connecting nuts 3/8"; (1) ball check valve 3/8" w/ stainless steel spring, EPDM seat & Santoprene® O-ring or Tantalum spring, FKM seat & O-ring; (1) weighted suction line strainer; 20-ft roll suction/discharge tubing; (1) additional pump tube; (1) mounting bracket; (1) quick start guide



STENNER PUMPS

SPECIFICATIONS

ACCURACY	±2%
SUCTION LIFT (ft)	25
POWER	120 VAC
CORD LENGTH (ft)	6
DUTY CYCLE	Continuous
MAX VISCOSITY (cP)	1500
CONTROL INPUTS	4 to 20 mA, 0 to 10 VDC, digital pulse, Hall effect
TURNDOWN	100:1
PUMP ENCLOSURE RATING	NEMA 4X

CERTIFICATIONS

- NSF 61 & 372, cULus, NSF/ANSI 50, CE IP65 (varies by model)

C&M PART #	MFG PART #	CONNECTION (TUBE OD)	FLOW MAX (GPD)	PRESSURE MAX (PSI)	PUMP TUBE	CHECK VALVE MATERIAL
A S30 MODELS WITH DUCKBILL CHECK VALVE OR INJECTION FITTING						
10552911F9DG	S3001AA101N	1/4"	5	100	1	Santoprene®
10552917F9DG	S3001AA301N	3/8"	5	100	1	Santoprene®
10552911T7DG	S3002AA101N	1/4"	17	100	2	Santoprene®
10552917T7DG	S3002AA301N	3/8"	17	100	2	Santoprene®
10552911ALDG	S3007AA101N	1/4"	40	100	7	Santoprene®
10552917ALDG	S3007AA301N	3/8"	40	100	7	Santoprene®
10552911BRX2	S3004AA101N	1/4"	60	25	4	N/A
10552917BRX2	S3004AA301N	3/8"	60	25	4	N/A
10552911CRX2	S3005AA101N	1/4"	85	25	5	N/A
10552917CRX2	S3005AA301N	3/8"	85	25	5	N/A
B S40 MODELS WITH SPRING LOADED BALL CHECK VALVE OR INJECTION FITTING						
10553917BRDG	S407XAA3011	3/8"	60	100	7X	Ceramic/Tantalum/FKM
10553917EDX2	S405XAA3011	3/8"	150	25	5X	Ceramic/Tantalum/FKM
10554117BRDG	S407XAA3012	3/8"	60	100	7X	Ceramic/SS/EPDM
10554117EDX2	S405XAA3012	3/8"	150	25	5X	Ceramic/SS/EPDM
C S50 MODELS						
1119591107X2	S505GAA3011	3/8"	315	25	5G	Ceramic/Tantalum/FKM
1119591207X2	S505GAA3012	3/8"	315	25	5G	Ceramic/Tantalum/FKM
11195911DUDG	S507GAA3011	3/8"	125	100	7G	Ceramic/SS/EPDM
11195912DUDG	S507GAA3012	3/8"	125	100	7G	Ceramic/SS/EPDM

REPLACEMENT PARTS & ACCESSORIES

C&M PART #	MFG PART #	DESCRIPTION	COMPATIBLE WITH
105543	MCCP201	#1 Santoprene® Tube, 5/Pack	S30 models
105544	MCCP202	#2 Santoprene® Tube, 5/Pack	S30 models
105545	MCCP207	#7 Santoprene® Tube, 5/Pack	S30 models
105546	MCCP204	#4 Santoprene® Tube, 5/Pack	S30 models
105547	MCCP205	#5 Santoprene® Tube, 5/Pack	S30 models
105548	S4007X-5	#7X Santoprene® Tube, 5/Pack	S40 models
105549	S4005X-5	#5X Santoprene® Tube, 5/Pack	S40 models
111967	S5005G-5	#5G Santoprene® Tube, 5/Pack	S50 models
111969	S5007G-5	#7G Santoprene® Tube, 5/Pack	S50 models

Stenner S-Variable Series Chemical Feed Pumps

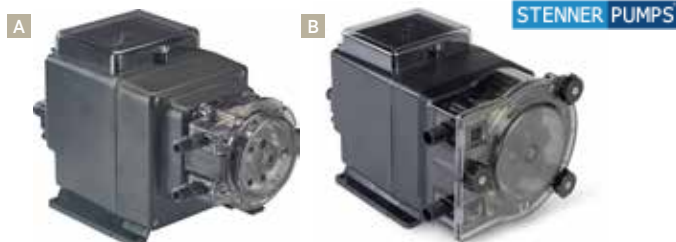

The S-Variable Pumps offer you durability and practical functions such as remote operation, backup pump capability and leak detection for water, wastewater and industrial applications. The pump features LED performance indicators and three output relays for sending signals to a separate device such as a process control system or a backup pump; Leak Detect, red LED blinks, sends relay to indicate leak is detected; Run, solid green LED, sends relay to indicate pump is operating; transfer, sends relay from primary pump to transfer operation to a backup pump if there is a loss of power, a drive fault or a leak is detected. A durable NEMA 4X rated enclosure protects pump from corrosion and extreme environments.

The variable-speed pumps have 20:1 turndown and run at the speed set with the adjustable potentiometer when power is applied, or the standby input is removed.

FEATURES & BENEFITS

- Self-priming—does not lose prime or vapor lock
- Can inject off-gassing solutions and can run dry
- Three-point roller design assist with anti-siphoning
- Output volume not affected by back pressure
- Foot, prime or degassing valve not required
- Leak Detection with dedicated output relay
- Simple tube replacement
- LED pump status indicators
(Run/Fault, Standby/Off, Leak and Power)
- Three dedicated output relays (Leak Detect, Run and Transfer)
- Durable NEMA 4X rated enclosure

WETTED MATERIALS

S3V Models: (3) connecting nuts 1/4" & (3) ferrules 1/4", or (3) connecting nuts 3/8" & (2) adapters 3/8"; (1) injection fitting (25 PSI) or (1) duckbill check valve (100 PSI); (1) weighted suction line strainer; 20-ft roll suction/discharge tubing; (1) additional pump tube; (2) additional latches; (1) mounting bracket; (1) manual

S4V Models: (3) connecting nuts 3/8"; (1) ball check valve 3/8" w/ stainless steel spring, EPDM seat & Santoprene® O-ring or Tantalum spring, FKM seat & O-ring; (1) weighted suction line strainer; 20-ft roll suction/discharge tubing; (1) pump tube; (1) mounting bracket; (1) manual

INCLUDES

(1) Injection valve (25 PSI), (1) duckbill check valve (100 PSI), (3) connecting nuts, (3) ferrules, (1) weighted suction line strainer, 20-ft L roll white suction/discharge tubing, (1) spare pump head tube, (2) additional latches and (1) mounting bracket

SPECIFICATIONS

ACCURACY	±2%
SUCTION LIFT (ft)	25
POWER	120 VAC
CORD LENGTH (ft)	6
DUTY CYCLE	Continuous
MAX VISCOSITY (cP)	1500
TURNDOWN	20:1 Variable-Speed Pumps
PUMP ENCLOSURE RATING	NEMA 4X

CERTIFICATIONS

- NSF 61 & 372, cULus, NSF 50, CE IP65 (varies by model)

C&M PART #	MFG PART #	CONNECTION (TUBE OD)	FLOW MAX (GPD)	PRESSURE MAX (PSI)	TUBE #	CHECK VALVE MATERIAL
A S-VARIABLE SPEED PUMPS						
10556411F9DG	S3V01AA101N	1/4"	5	100	1	Santoprene®
10556417F9DG	S3V01AA301N	3/8"	5	100	1	Santoprene®
10556411T7DG	S3V02AA101N	1/4"	17	100	2	Santoprene®
10556417T7DG	S3V02AA301N	3/8"	17	100	2	Santoprene®
10556411ALDG	S3V07AA101N	1/4"	40	100	7	Santoprene®
10556417ALDG	S3V07AA301N	3/8"	40	100	7	Santoprene®
10556411BRX2	S3V04AA101N	1/4"	60	25	4	N/A
10556417BRX2	S3V04AA301N	3/8"	60	25	4	N/A
10556411CRX2	S3V05AA101N	1/4"	85	25	5	N/A
10556417CRX2	S3V05AA301N	3/8"	85	25	5	N/A
B S4V MODELS WITH SPRING LOADED BALL CHECK VALVE OR INJECTION FITTING						
10557417BRDG	S4V7XAA3011	3/8"	60	100	7X	Ceramic/ Tantalum/FKM
10557417EDX2	S4V5XAA3011	3/8"	150	25	5X	Ceramic/ Tantalum/FKM
10557617BRDG	S4V7XAA3012	3/8"	60	100	7X	Ceramic/SS/ EPDM
10557617EDX2	S4V5XAA3012	3/8"	150	25	5X	Ceramic/SS/ EPDM

REPLACEMENT PARTS & ACCESSORIES

C&M PART #	MFG PART #	DESCRIPTION	COMPATIBLE WITH
105543	MCCP201	#1 Santoprene® Tube, 5/Pack	S3V Models
105544	MCCP202	#2 Santoprene® Tube, 5/Pack	S3V Models
105545	MCCP207	#7 Santoprene® Tube, 5/Pack	S3V Models
105546	MCCP204	#4 Santoprene® Tube, 5/Pack	S3V Models
105547	MCCP205	#5 Santoprene® Tube, 5/Pack	S3V Models
105548	S4007X-5	#7X Santoprene® Tube, 5/Pack	S4V Models
105549	S4005X-5	#5X Santoprene® Tube, 5/Pack	S4V Models

Stenner S420 Series Chemical Feed Pumps

Use the S420 Series Metering Pumps with pH or ORP monitors to help maintain proper water chemistry and treatment of effluent discharge water. These self-priming, variable-speed pumps accept a 4 to 20 mA analog input signal and can inject liquid solutions in direct proportion to the signal. When using with analog input, you can scale the signal from 25 to 100% of the maximum flow rate output to achieve the desired flow rate. Maximum flow rate output is adjustable from 5 to 100% when operating pump manually. A single dial and mode operation button allow for easy manual operation.

A robust NEMA 4X rated enclosure protects the pump from corrosion and extreme environments. The leak detection feature includes an illuminated LED status indicator and a dedicated output relay that stops the pump from operating when a leak is detected. The pump also offers backup capability to the primary pump to maintain operation in critical applications. When activated, the primary pump seamlessly transfers operation to the backup pump. There are additional LED indicators that communicate the status of the pump.

FEATURES & BENEFITS

- Self-priming—does not lose prime or vapor lock
- Can inject off-gassing solutions and can run dry
- Three-point roller design assist with anti-siphoning
- Output volume not affected by back pressure
- Foot, prime or degassing valve not required
- Leak detection with dedicated output relay
- Simple tube replacement
- LED pump status indicators (Run/Fault, Standby/Off, Leak and Power)
- Three dedicated output relays (Leak Detect, Run and Transfer)
- Accepts 4 to 20 mA analog signal
- Durable NEMA 4X rated enclosure

WETTED MATERIALS

Santoprene® pump tube & duckbill; PVC or Polypropylene tube fittings, injection fittings, suction line strainer, connecting nuts & adapters; Polyethylene ferrules & suction/discharge tubing; Hastelloy® leak detect components; tantalum & FKM or Stainless steel, EPDM & Santoprene® ball check valve components

INCLUDES

S34 Models include: (3) connecting nuts 1/4" & (3) ferrules 1/4", or (3) connecting nuts 3/8" & (2) adapters 3/8"; (1) injection fitting (25 PSI) or (1) duckbill check valve (100 PSI); (1) weighted suction line strainer; 20-ft roll suction/discharge tubing; (1) additional pump tube; (2) additional latches; (1) mounting bracket; (1) manual

S44 models include: (3) connecting nuts 3/8"; (1) ball check valve 3/8" w/ stainless steel spring, EPDM seat & Santoprene® O-ring or Tantalum spring, FKM seat & O-ring; (1) weighted suction line strainer; 20-ft roll suction/discharge tubing; (1) additional pump tube; (1) mounting bracket; (1) manual



STENNER PUMPS

SPECIFICATIONS

ACCURACY	±2%
SUCTION LIFT (ft)	25
POWER	120 VAC
CORD LENGTH (ft)	6
DUTY CYCLE	Continuous
MAX VISCOSITY (cP)	1500
CONTROL INPUTS	4 to 20 mA, contact closure for remote start/stop
TURNDOWN	100:1 (4 to 20 mA), 20:1 (Manual Mode)
PUMP ENCLOSURE RATING	NEMA 4X

CERTIFICATIONS

- NSF 61 & 372, cULus, NSF 50, CE IP65 (varies by model)

C&M PART #	MFG PART #	CONNECTION (TUBE OD)	FLOW MAX (GPD)	PRESSURE MAX (PSI)	TUBE #	CHECK VALVE MATERIAL
S34 MODELS WITH DUCKBILL INJECTION CHECK VALVE OR INJECTION FITTING						
10564011F9DG	S3401AA101N	1/4"	5	100	1	Santoprene®
10564017F9DG	S3401AA301N	3/8"	5	100	1	Santoprene®
10564011T7DG	S3402AA101N	1/4"	17	100	2	Santoprene®
10564017T7DG	S3402AA301N	3/8"	17	100	2	Santoprene®
10564011ALDG	S3407AA101N	1/4"	40	100	7	Santoprene®
10564017ALDG	S3407AA301N	3/8"	40	100	7	Santoprene®
10564011BRX2	S3404AA101N	1/4"	60	25	4	N/A
10564017BRX2	S3404AA301N	3/8"	60	25	4	N/A
10564011CRX2	S3405AA101N	1/4"	85	25	5	N/A
10564017CRX2	S3405AA301N	3/8"	85	25	5	N/A
S44 MODELS WITH SPRING LOADED INJECTION BALL CHECK VALVE						
10565017BRDG	S447XAA3011	3/8"	60	100	7X	Ceramic/Tantalum/FKM
10565017EDX2	S445XAA3011	3/8"	150	25	5X	Ceramic/Tantalum/FKM
10565217BRDG	S447XAA3012	3/8"	60	100	7X	Ceramic/SS/EPDM
10565217EDX2	S445XAA3012	3/8"	150	25	5X	Ceramic/SS/EPDM

REPLACEMENT PARTS & ACCESSORIES

C&M PART #	MFG PART #	DESCRIPTION	COMPATIBLE WITH
105543	MCCP201	#1 Santoprene® Tube, 5/Pack	S34 models
105544	MCCP202	#2 Santoprene® Tube, 5/Pack	S34 models
105545	MCCP207	#7 Santoprene® Tube, 5/Pack	S34 models
105546	MCCP204	#4 Santoprene® Tube, 5/Pack	S34 models
105547	MCCP205	#5 Santoprene® Tube, 5/Pack	S34 models
105548	S4007X-5	#7X Santoprene® Tube, 5/Pack	S44 models
105549	S4005X-5	#5X Santoprene® Tube, 5/Pack	S44 models

Stenner Classic Series Chemical Feed Pumps

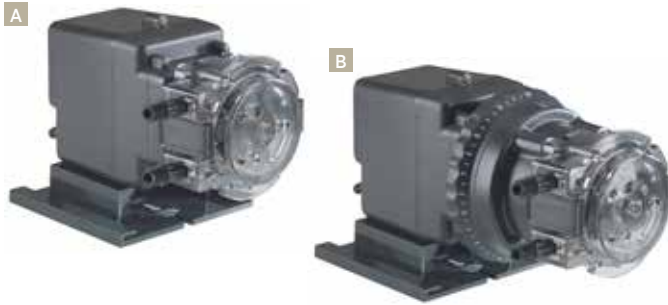

The Classic Series Peristaltic Pumps remain a versatile and popular choice with installers. Use these pumps for dosing solution for drinking water disinfection, pH control, oxidation, corrosion and scale control and more. These pumps do not require any tools to service—simply replace the tubing assembly when needed. Select from Classic 45 and higher flow rate Classic 85 pump models, available in fixed flow rate or adjustable flow rate models. Adjustable models feature external dial ring feed rate control in 2.5% increments, 20:1 turn down.

FEATURES & BENEFITS

- Manually adjust flow rate output
- Self-priming—does not lose prime or vapor lock
- Pumps off-gassing solutions and can run dry
- Three-point roller design assists with anti-siphon
- Tube replacement without tools
- Output volume not affected by back pressure

WETTED MATERIALS

Santoprene® pump tube & duckbill; PVC or Polypropylene tube fittings, injection fittings, suction line strainer, connecting nuts & adapters; Polyethylene ferrules & suction/discharge tubing

INCLUDES

(3) connecting nuts 1/4" & (3) ferrules, or (3) connecting nuts 3/8" & (2) adapters 3/8"; (1) injection fitting (25 PSI) or (1) duckbill check valve (100 PSI); (1) weighted suction line strainer; 20-ft roll suction/discharge tubing, (1) additional pump tube; (2) additional latches; (1) mounting bracket; (1) manual

SPECIFICATIONS

ACCURACY	±2%
SUCTION LIFT (ft)	25
POWER	120 VAC
CORD LENGTH (ft)	6
DUTY CYCLE	Continuous
MAX VISCOSITY (cP)	1500
PUMP HOUSING MATERIAL	Polycarbonate

CERTIFICATIONS

- NSF 61 & 372, UL, CSA, NSF 50, CE (varies by model)

STENNER PUMPS

C&M PART #	MFG PART #	CONNECTION (TUBE OD)	FLOW MAX (GPD)	PRESSURE MAX (PSI)	TUBE #
A FIXED-RATE PUMPS					
1056181187DG	45MFH1A1SUAA	1/4"	3	100	1
1056181787DG	45MFH1A3SUAA	3/8"	3	100	1
10561811F9DG	85MFH1A1SUAA	1/4"	5	100	1
10561817F9DG	85MFH1A3SUAA	3/8"	5	100	1
10561811N8DG	45MFH2A1SUAA	1/4"	10	100	2
10561817N8DG	45MFH2A3SUAA	3/8"	10	100	2
10561811T7DG	85MFH2A1SUAA	1/4"	17	100	2
10561817T7DG	85MFH2A3SUAA	3/8"	17	100	2
10561811W2DG	45MFH7A1SUAA	1/4"	22	100	7
10561817W2DG	45MFH7A3SUAA	3/8"	22	100	7
10561811ALDG	85MFH7A1SUAA	1/4"	40	100	7
10561817ALDG	85MFH7A3SUAA	3/8"	40	100	7
10561811BCX2	45MFL5A1SUAA	1/4"	50	25	5
10561817BCX2	45MFL5A3SUAA	3/8"	50	25	5
10561811CRX2	85MFL5A1SUAA	1/4"	85	25	5
10561817CRX2	85MFL5A3SUAA	3/8"	85	25	5
B ADJUSTABLE-RATE PUMPS, 20:1 TURN DOWN RATIO					
1056021187DG	45MJH1A1STAA	1/4"	3	100	1
1056021787DG	45MJH1A3STAA	3/8"	3	100	1
10560211F9DG	85MJH1A1STAA	1/4"	5	100	1
10560217F9DG	85MJH1A3STAA	3/8"	5	100	1
10560211N8DG	45MJH2A1STAA	1/4"	10	100	2
10560217N8DG	45MJH2A3STAA	3/8"	10	100	2
10560211T7DG	85MJH2A1STAA	1/4"	17	100	2
10560217T7DG	85MJH2A3STAA	3/8"	17	100	2
10560211W2DG	45MJH7A1STAA	1/4"	22	100	7
10560217W2DG	45MJH7A3STAA	3/8"	22	100	7
10560211ALDG	85MJH7A1STAA	1/4"	40	100	7
10560217ALDG	85MJH7A3STAA	3/8"	40	100	7
10560211BCX2	45MJL5A1STAA	1/4"	50	25	5
10560217BCX2	45MJL5A3STAA	3/8"	50	25	5
10560211CRX2	85MJL5A1STAA	1/4"	85	25	5
10560217CRX2	85MJL5A3STAA	3/8"	85	25	5

REPLACEMENT PARTS & ACCESSORIES

C&M PART #	MFG PART #	DESCRIPTION
105543	MCCP201	#1 Santoprene®, 5/Pack
105544	MCCP202	#2 Santoprene®, 5/Pack
105545	MCCP207	#7 Santoprene®, 5/Pack
105547	MCCP205	#5 Santoprene®, 5/Pack

Stenner Classic Series Double-Head Chemical Feed Pumps

Use these Double-Head, Adjustable Peristaltic Pumps to dose solutions such as sodium hypochlorite, acids and polyphosphates for common water treatment applications that include disinfection, pH control, corrosion and scale control and oxidation. This pump series provides twice the output of a single-head pump and can also be used to inject two compatible solutions at the same ratio. The feed rate control has an external dial ring labeled from L to 10, offering you an adjustable output of 5 to 100% in 2.5% increments, 20:1 turndown. These pumps are easy to service, no tools required.

FEATURES & BENEFITS

- Inject two compatible solutions at the same ratio
- Manually adjust flow rate output
- Self-priming—does not lose prime or vapor lock
- Pumps off-gassing solutions and can run dry
- Three-point roller design assists with anti-siphon
- Tube replacement without tools
- Output volume not affected by back pressure

WETTED MATERIALS

Santoprene® pump tube & duckbill; PVC or Polypropylene tube fittings, injection fittings, suction line strainer, connecting nuts & adapters; Polyethylene ferrules & suction/discharge tubing

INCLUDES

(6) connecting nuts 1/4" & (6) ferrules, or (6) connecting nuts 3/8" & (4) adapters 3/8"; (1) injection fitting (25 PSI) or (1) duckbill check valve (100 PSI); (1) weighted suction line strainer; 20-ft roll suction/discharge tubing, (1) additional pump tube; (2) additional latches; (1) mounting bracket; (1) manual

STENNER PUMPS



SPECIFICATIONS

ACCURACY	±2%
SUCTION LIFT (ft)	25
POWER	120 VAC
CORD LENGTH (ft)	6
DUTY CYCLE	Continuous
MAX VISCOSITY (cP)	1500
PUMP HOUSING MATERIAL	Polycarbonate

CERTIFICATIONS

- NSF 61 & 372, UL, CSA, NSF 50, CE (varies by model)

C&M PART #	MFG PART #	CONNECTION (TUBE OD)	FLOW MAX (GPD)	PRESSURE MAX (PSI)	TUBE #
10563411DGX2	100JL5A1STAA	1/4"	100	25	5
10563417DGX2	100JL5A3STAA	3/8"	100	25	5
10563411DSX2	170JL4A1STAA	1/4"	120	25	4
10563417DSX2	170JL4A3STAA	3/8"	120	25	4
10563411EJX2	170JL5A1STAA	1/4"	170	25	5
10563417EJX2	170JL5A3STAA	3/8"	170	25	5

REPLACEMENT PARTS & ACCESSORIES

C&M PART #	MFG PART #	DESCRIPTION
105546	MCCP204	#4 Santoprene®, 5/Pack
105547	MCCP205	#5 Santoprene®, 5/Pack

Stenner STS Polyethylene Chemical Solution Tanks

The lightweight and rugged STS Polyethylene Chemical Solution Tanks are perfect for storing chemical solutions. Each tank has incremental solution level indicators and come with a polypropylene lid. Select from UV-resistant gray or translucent white. Viton grommets and stainless-steel screws provide excellent chemical resistance. Tanks works with Stenner Pump models: 45, 85, S30, S40, S34, S44, S3P, S4M and Econ® pumps (except E10T01 and E20T01—order mounting kit below.)

C&M PART #	MFG PART #	CAPACITY (GAL)	COLOR
105678	STS15NC	15	Translucent
105679	STS15GC	15	UV Gray
105680	STS30NC	30	Translucent
105681	STS30GC	30	UV Gray

REPLACEMENT PARTS & ACCESSORIES

C&M PART #	MFG PART #	DESCRIPTION
105682	EC303	Econ Pump Mounting Kit for Stenner STS Tank (required for E10T01 and E20T01)



105679

105681

STENNER PUMPS

Stenner Econ T Pumps with Built-In Timer

Use these compact Econ T Peristaltic Pumps for light-duty dosing control timed applications. Program up to 24 independent on and off events within a 7-day period with each programmed event ranging from 1 minute to 23 hours and 59 minutes. Control panel features a 24-hour integral clock that has a battery backup to maintain the time of day. Pumps are ideal for injection of enzymes for odor control or drain line maintenance, biocide feed in small cooling towers or water fountains and phosphate reducers.

FEATURES & BENEFITS

- Effortless tube replacement without tools
- Simple programming with LCD display, includes cover for wet environments
- Wall mountable
- Patented quick-release pump head design
- Self-priming—does not lose prime or vapor lock
- Pumps off-gassing solutions and can run dry
- 3-point roller design assists with anti-siphon
- Output volume not affected by back pressure

WETTED MATERIALS

Santoprene® pump tube & duckbill; PVC or Polypropylene tube fittings, injection fittings, suction line strainer & connecting nuts; Polyethylene ferrules & suction/discharge tubing

INCLUDES

(3) connecting nuts 1/4" & (3) ferrules 1/4"; (1) injection fitting (25 PSI) or (1) duckbill check valve (80 PSI); (1) weighted suction line strainer; 20-ft roll suction/discharge tubing; (1) additional pump tube; (1) mounting bracket; (1) manual

STENNER PUMPS

SPECIFICATIONS

ACCURACY	±5%
SUCTION LIFT (ft)	25
MAX VISCOSITY (cP)	100
POWER	120 VAC



CERTIFICATIONS

- NSF 61 & 372, cULus, NSF 50, CE (varies by model)

C&M PART #	MFG PART #	CONNECTION (TUBE OD)	FLOW MAX (GPD)	PRESSURE MAX (PSI)	PUMP TUBE
10565470X2	E10T1A71S8	1/4"	2.5	25	A
105654F9X2	E10T2A71S8	1/4"	5.0	25	A
1056540NX2	E10T2B71S8	1/4"	8.5	25	B
105654S2X2	E10T2C71S8	1/4"	15	25	C
1056542XCM	E10T1F71S8	1/4"	0.6	80	F
1056543XCM	E10T2F71S8	1/4"	1.3	80	F
1056544XCM	E20T4F71S8	1/4"	3.4	80	F
105654IWCM	E20T4G71S8	1/4"	12.3	80	G
105654MCCM	E20T4H71S8	1/4"	21.7	80	H

REPLACEMENT PARTS & ACCESSORIES

C&M PART #	MFG PART #	DESCRIPTION
105663	EC30A-2	A Santoprene® Tube 2/Pack
105664	EC30B-2	B Santoprene® Tube 2/Pack
105665	EC30C-2	C Santoprene® Tube 2/Pack
105666	EC30F-2	F Santoprene® Tube 2/Pack
105667	EC30G-2	G Santoprene® Tube 2/Pack
105668	EC30H-2	H Santoprene® Tube 2/Pack

HACH DR300 POCKET COLORIMETERS



See our **Lab Catalog** or visit supply.coreandmain.com for Hach's DR300 Pocket Colorimeters, reagents and standards.

Stenner Battery-Powered Econ-TD Pumps with Built-In Timer

STENNER PUMPS



The Econ TD Peristaltic Pumps are designed for timed applications for 5 psi or less. These battery-powered pumps are ideal for areas where power is not easily accessible. Program up to 24 independent on and off events within a 7-day period with each programmed event ranging from 1 minute to 23 hours and 59 minutes. Control panel features a 24-hour integral clock that has a battery backup to maintain the time of day. The LCD display with cover allows for indoor and outdoor use. Use the pumps for commercial drain line maintenance, grease trap treatment or installations requiring odor control. Select pump with FKM tube for injecting D-limonene.

FEATURES & BENEFITS

- Battery powered—ideal for areas with no AC power access
- Select FKM tube for injecting D-limonene
- Effortless tube replacement without tools
- Simple programming with LCD display, includes cover for wet environments
- Wall mountable
- Patented quick-release pump head design
- Self-priming—does not lose prime or vapor lock
- Pumps off-gassing solutions and can run dry
- Three-point roller design assists with anti-siphon

WETTED MATERIALS

FKM or Silicone pump tube w/polypropylene adapter fittings, polyethylene suction/discharge tubing, polypropylene/PVC suction strainer and PVC injection fitting

INCLUDES

- (3) connecting nuts 1/4" & (3) ferrules 1/4";
- (1) injection fitting; (1) ceramic weight w/clip;
- 20-ft roll suction/discharge tubing;
- (1) mounting bracket; (1) manual

SPECIFICATIONS

ACCURACY	±15% Varies according to battery strength
SUCTION LIFT (ft)	5
MAX VISCOSITY (cP)	100
POWER	(8) D Cells or (2) 6 V Lantern Batteries (NOT Included)

CERTIFICATIONS

- cUL

C&M PART #	MFG PART #	CONNECTION (TUBE OD)	FLOW MAX (GPD)	PRESSURE MAX (PSI)	PUMP TUBE	TUBE MATERIAL
10567133	E10T01C30B1	1/4"	24.7	5	C3	FKM
105671MJ	E20T01C30B1	1/4"	41.7	5	C3	FKM
105671Y2	E10T01C40B1	1/4"	27	5	C4	Silicone
105671AU	E20T01C40B1	1/4"	45	5	C4	Silicone

REPLACEMENT PARTS & ACCESSORIES

C&M PART #	MFG PART #	DESCRIPTION
105673	EC3C3-2	C3 Econ TD Pump Tube, FKM, 2/Pack
105677	EC3C4-2	C4 Econ TD Pump Tube, Silicone, 2/Pack

Stenner Pump Heads



STENNER PUMPS

Quickly and easily replace tubes without tools. Pump heads feature a three-point roller design that assists with anti-siphon. Simply see the table to select the correct pump head for your pump.

INCLUDES

25 PSI QP & S3QP Heads:

Pump tube, 1/4" ferrules

100 PSI QP & S3QP Heads: Pump tube, 1/4" ferrules, Santoprene® duckbill

S4 & S5 Heads: Pump tube

S40, S50 Complete pump head assemblies include pump tube

C&M PART #	MFG PART #	DESCRIPTION	PSI	WORKS w/STENNER PUMP SERIES
105550	S3101-1	#1 Santoprene® S3QP Pump Head	100	S30, S34, S3P, S3V
105551	S3102-1	#2 Santoprene® S3QP Pump Head	100	S30, S34, S3P, S3V
105552	S3107-1	#7 Santoprene® S3QP Pump Head	100	S30, S34, S3P, S3V
105553	S3104-1	#4 Santoprene® S3QP Pump Head	25	S30, S34, S3V
105554	S3105-1	#5 Santoprene® S3QP Pump Head	25	S30, S34, S3V
105555	S4107X-1	#7X Santoprene® S4 Pump Head	100	S40, S44, S4V w/ screws
105556	S4105X-1	#5X Santoprene® S4 Pump Head	25	S40, S44, S4V w/ screws
111970	S5105G-1	#5G Santoprene® S5 Pump Head	25	S50
111973	S5107G-1	#7G Santoprene® S5 Pump Head	100	S50
105722	QP101-1	#1 Santoprene® QP Pump Head	100	45, 85, 100, 170
105723	QP102-1	#2 Santoprene® QP Pump Head	100	45, 85, 100, 170
105724	QP107-1	#7 Santoprene® QP Pump Head	100	45, 85
105725	QP252-1	#1 Santoprene® QP Pump Head	25	45, 85, 100, 170
105726	QP253-1	#3 Santoprene® QP Pump Head	25	45, 85, 100, 170
105727	QP254-1	#4 Santoprene® QP Pump Head	25	45, 85, 100, 170
105728	QP255-1	#5 Santoprene® QP Pump Head	25	45, 85, 100, 170
105769	QPA101-1	#1 Santoprene® QP Innermost Pump Head	100	100, 170
105770	QPA102-1	#2 Santoprene® QP Innermost Pump Head	100	100, 170
105771	QPA253-1	#3 Santoprene® QP Innermost Pump Head	25	100, 170
105722	QPA254-1	#4 Santoprene® QP Innermost Pump Head	25	100, 170
105733	QPA255-1	#5 Santoprene® QP Innermost Pump Head	25	100, 170

Stenner Pump Tube Packs

STENNER PUMPS



Replacement Pump Tubes are easy to replace. On each pump tube, a number or letter is molded into the pump tube fitting to represent the size.

C&M PART #	MFG PART #	DESCRIPTION
105543	MCCP201	#1 Santoprene® Tube, 5/Pack
105544	MCCP202	#2 Santoprene® Tube, 5/Pack
105545	MCCP207	#7 Santoprene® Tube, 5/Pack
105546	MCCP204	#4 Santoprene® Tube, 5/Pack
105547	MCCP205	#5 Santoprene® Tube, 5/Pack
105548	S4007X-5	#7X Santoprene® Tube, 5/Pack
105549	S4005X-5	#5X Santoprene® Tube, 5/Pack
111967	S5005G-5	#5G Santoprene® Tube, 5/Pack
111969	S5007G-5	#7G Santoprene® Tube, 5/Pack
105749	MCTYG02	#2 Versilon™ Tube, 5/Pack
105750	MCTYG05	#5 Versilon™ Tube, 5/Pack
105663	EC30A-2	A Santoprene® Tube 2/Pack
105664	EC30B-2	B Santoprene® Tube 2/Pack
105665	EC30C-2	C Santoprene® Tube 2/Pack
105666	EC30F-2	F Santoprene® Tube 2/Pack
105667	EC30G-2	G Santoprene® Tube 2/Pack
105668	EC30H-2	H Santoprene® Tube 2/Pack
105673	EC3C3-2	C3 FKM Tube 2/Pack
105677	EC3C4-2	C4 Silicone Tube 2/Pack

Stenner Check Valves, Duckbills & Miscellaneous Parts

C&M PART #	MFG PART #	DESCRIPTION
105753	UCDBINJ	Santoprene® Duckbill Check Valve, 1/4"
105754	UCINJ38	Santoprene® Duckbill Check Valve, 3/8"
105755	UCCVDBO	Santoprene® Duckbill, 2/Pack
105756	MCCVDBO	Santoprene® Duckbill, 5/Pack
105757	MCADPTR	Lead Tube Adapter w/ Nut, 3/8", 5/Pack
105758	UCAK100	Connecting Nut, 1/4", 10/Pack
105759	MCAK100	Connecting Nut, 1/4", 24/Pack
105761	UCAK200	Ferrule, 1/4", 10/Pack
105762	UCAK300	Injection Fitting
105763	ST114	Suction Line Strainer w/ Ceramic Weight, 1/4"
105764	ST138	Suction Line Strainer w/ Ceramic Weight, 3/8"
105765	MAGRE55	Pump Grease, 5.5 oz.

Stenner Pump Head Service Kits

STENNER PUMPS



Simply see the table below to select the correct service kit for your pump.

INCLUDES

Pump tube, roller assembly, ferrules, connecting nuts and latches (100 PSI models include duckbill)

S4, S5 compatible kits include roller assembly and tube, 3/8" nuts

C&M PART #	MFG PART #	DESCRIPTION	PSI	WORKS w/STENNER PUMP SERIES
105692	QP251K	#1 Santoprene® Tube QP Kit	25	45, 85, 100, 170
105693	QP252K	#2 Santoprene® Tube QP Kit	25	45, 85, 100, 170
105694	QP253K	#3 Santoprene® Tube QP Kit	25	45, 85, 100, 170
105695	QP254K	#4 Santoprene® Tube QP Kit	25	45, 85, 100, 170
105696	QP255K	#5 Santoprene® Tube QP Kit	25	45, 85, 100, 170
105697	QP25TIK	#1 Versilon® Tube QP Kit	25	45, 85, 100, 170
105698	QP25T2K	#2 Versilon® Tube QP Kit	25	45, 85, 100, 170
105699	QP25T5K	#5 Versilon® Tube QP Kit	25	45, 85, 100, 170
105700	QP101K	#1 Santoprene® Tube QP Kit	100	45, 85, 100, 170
105701	QP102K	#2 Santoprene® Tube QP Kit	100	45, 85, 100, 170
105702	QP107K	#7 Santoprene® Tube QP Kit	100	45, 85
105703	QP10TIK	#1 Versilon® Tube QP Kit	100	45, 85, 100, 170
105704	QP10T2K	#2 Versilon® Tube QP Kit	100	45, 85, 100, 170
105557	S3101K	#1 Santoprene® S3QP Kit	100	S30, S34, S3P, S3V
105558	S3102K	#2 Santoprene® S3QP Kit	100	S30, S34, S3P, S3V
105559	S3107K	#7 Santoprene® S3QP Kit	100	S30, S34, S3V
105560	S3104K	#4 Santoprene® S3QP Kit	25	S30, S34, S3V
105561	S3105K	#5 Santoprene® S3QP Kit	25	S30, S34, S3V
105562	S4107XK	#7X Santoprene® S4 Kit	100	S40, S44, S4V w/ screws
105563	S4105XK	#5X Santoprene® S4 Kit	25	S40, S44, S4V w/ screws
111972	S5105GK	#5G Santoprene® S5 Kit	25	S50
111975	S5107GK	#7G Santoprene® S5 Kit	100	S50

STENNER PUMPS



LMI KML Series Peristaltic Chemical Feed Pumps

The KML Series Chemical Feed Pumps are designed for the municipal market and provide many outstanding features such as up to 10,000:1 turn down ratio, 5-year warranty and a best-in-class user experience featuring one-button switching between local and remote operation. No need for complex, multi-step menu navigation each time a mode change is required. A tube change does not require any manipulation of the tube while rotor is turning ensuring worker safety. Patent-pending rotor assembly releases tube compression during maintenance.

Pumps listed in ordering table are SCADA/local control models which can be field upgraded to add features and communications options such as Modbus and Ethernet/IP. This allows you to purchase a pump that meets current needs at a lower price, with the option of upgrading in the future.

These pumps feature a 13-button keypad, 4.33" color LCD display, optical tube leak detection, onboard run timer for predictive maintenance, passcode security lock, USB port for firmware upgrades/downloading of operating history and (4) programmable Form-C output relays. Pumps include an LMI XL extended life tube set that has excellent acid and alkali resistance similar to Tygon® and is compatible with numerous oxidizing agents such as sodium hypochlorite. NEMA 4X enclosure provides a superior level of protection from corrosion and extreme environments.

Use for applications to include pumping: sodium hypochlorite, polymers, fluoride, pH and odor control, ferric chloride and sodium hydroxide.

FEATURES & BENEFITS

- Self-priming up to 30 ft
- No moving parts in liquid path, tubing is the only wetted item
- No check balls/check valves
- Can run dry
- Pump will not vapor lock or air bind
- NEMA 4X enclosure
- Tool free tubing change

NOTE: Tube is either a single or twin. Example: KML2-4-AAD1-1 = single tube, KML2-4-AAE2-1 = twin tube.

SPECIFICATIONS

POWER	115 VAC
MAX VISCOSITY (cP)	12,000
INPUTS	(3) Contact Inputs: Remote Stop Signal; Pump Direction; Start Signal, (1) 4 to 20 mA Analog Speed Control, (1) Pulse Input Speed Control
OUTPUTS	(4) Output Relays, Configurable, Select to Indicate Auto/Remote Mode; General Alarm; Door Open; Leak Detected; Pump Off; Remote Stop Alarm; Pump Disabled, (1) 4 to 20 mA Speed Feedback Signal, (1) Pulse Speed Feedback Signal
SUCTION LIFT (ft)	30
TURNDOWN RATIO	10,000:1
ENCLOSURE RATING	NEMA 4X

CERTIFICATIONS

- NSF-61



C&M PART #	MFG PART #	FLOW MAX (GPD)	PRESSURE MAX (PSI)	CONNECTION	TUBE ASSEMBLY
40164974DG	KML2-4-AAD1-1	40.8	100	3/8" Tube OD	K2-AAD1
40164975NI	KML2-4-AAE2-1	105.6	110	3/8" Tube OD	K2-AAE2
40164976NI	KML2-4-AAG2-1	410.4	110	3/8" Tube OD	K2-AAG2
40165278DG	KML3-4-AAD1-1	50.4	100	3/8" Tube OD	K3-AAD1
40165279DG	KML3-4-AAE2-1	112.8	100	3/8" Tube OD	K3-AAE2
40165280NI	KML3-4-AAG2-1	453.6	110	3/8" Tube OD	K3-AAG2
40165282DG	KML3-4-AAK1-1	796.8	100	3/8" Tube OD	K3-AAK1
40165282Z1	KML3-4-AAKL-1	796.8	30	3/8" Tube OD	K3-AAK1
40165783DG	KML4-4-AAH1-1	681.6	100	1/2" NPT(M)	K4-AAH1
40165784DG	KML4-4-AAH2-1	1288.8	100	1/2" NPT(M)	K4-AAH2
40165788BC	KML4-4-AAL1-1	2388	50	1/2" NPT(M)	K4-AAL1
40165789Z1	KML4-4-AAP1-1	3804	30	1/2" NPT(M)	K4-AAP1

REPLACEMENT PARTS & ACCESSORIES

C&M PART #	MFG PART #	DESCRIPTION
LMI* XL TUBE ASSEMBLIES		
401736	K2-AAD1	1/2" MNPT and 3/8" tube compression, 0.075" ID
401737	K2-AAE2	1/2" MNPT and 3/8" tube compression, 0.125 ID twin
401738	K2-AAG2	1/2" MNPT and 3/8" tube compression, 0.187 ID twin
401739	K3-AAD1	1/2" MNPT and 3/8" tube compression, 0.075" ID
401740	K3-AAE2	1/2" MNPT and 3/8" tube compression, 0.125 ID twin
401741	K3-AAG2	1/2" MNPT and 3/8" tube compression, 0.187 ID twin
401742	K3-AAK1	1/2" MNPT and 3/8" tube compression, 0.375" ID
401743	K4-AAH1	1/2" MNPT, 0.25" ID
401744	K4-AAH2	1/2" MNPT, 0.25 ID twin
401745	K4-AAL1	1/2" MNPT, 0.5" ID
401746	K4-AAP1	1/2" MNPT, 0.75" ID
INSTALLATION KIT		
401751	KS-INSKIT	Includes suction and discharge tubing with foot and check valve
LMI* ROTOR ASSEMBLIES - INCLUDES SPACER BUSHINGS		
401752	K2-R-A	For K2, AD1 tubes
401753	K2-R-B	For K2, BH1 tubes
401754	K2-R-C	For K2, CG1 and CG2 tubes
401755	K2-R-D	For K2, AE2 and AG2 tubes
401756	K3-R-A	For K3, AD1 tubes
401757	K3-R-B	For K3, KL tubes
401758	K3-R-C	For K3, CG1, CG2, CK1 tubes
401759	K3-R-D	For K3, AE2, AG2, AK1 and BK1 tubes
401760	K4-R-A	For K4, AH1 and AH2 tubes
401761	K4-R-B	For K4, BH1 and BH2 tubes
401762	K4-R-C	For K4, CH1, CK1, CK2 tubes
401763	K4-R-D	For K4, AL1 and AP1 tubes

LMI KBL Series Peristaltic Chemical Feed Pumps



The KBL Series Chemical Feed Pumps have many outstanding features such as up to 200:1 turn down ratio, 2-year warranty and a best-in-class user experience featuring one-button switching between local and remote operation. No need for complex, multistep menu navigation each time a mode change is required. A tube change does not require any manipulation of the tube while rotor is turning ensuring worker safety. Patent-pending rotor assembly releases tube compression during maintenance.

Pumps listed in ordering table are expandable platform SCADA/ local control models which can be field upgraded to add features and communications options such as Modbus and Ethernet/IP. This allows you to purchase a pump that meets current needs at a lower price, with the option of upgrading in the future.

All models feature a 4.33" color LCD display, optical tube leak detection, onboard run timer for predictive maintenance, USB port for firmware upgrades/downloading of operating history and (4) programmable Form-C output relays. Pumps include an LMI XL extended life tube set that has excellent acid and alkali resistance similar to Tygon® and is compatible with numerous oxidizing agents such as sodium hypochlorite. It's best for fatigue life and is the longest-lasting tube in compatible applications.

FEATURES & BENEFITS

- Self-priming up to 30 ft
- No moving parts in liquid path, tubing is the only wetted item
- No check balls/check valves
- Can run dry
- Pump will not vapor lock or air bind
- Tool free tube change

NOTE: Tube is either a single or twin. Example:

KBL2-4-AAD1-1 = single tube, KBL2-4-AAE2-1 = twin tube.

SPECIFICATIONS

POWER	115 VAC
MAX VISCOSITY (cP)	12,000
INPUTS	(3) Contact Inputs: Remote Stop Signal; Pump Direction; Start Signal, (1) 4 to 20 mA Analog Speed Control, (1) Pulse Input Speed Control
OUTPUTS	(4) Output Relays, Configurable, Select to Indicate Auto/ Remote Mode; General Alarm; Door Open; Leak Detected; Pump Off; Remote Stop Alarm; Pump Disabled, (1) 4 to 20 mA Speed Feedback Signal, (1) Pulse Speed Feedback Signal
SUCTION LIFT (ft)	30
TURNDOWN RATIO	200:1

C&M PART #	MFG PART #	FLOW MAX (GPD)	PRESSURE MAX (PSI)	CONNECTION	TUBE ASSEMBLY
40166174DG	KBL2-4-AAD1-1	40.8	100	3/8" Tube OD	K2-AAD1
40166175NI	KBL2-4-AAE2-1	105.6	110	3/8" Tube OD	K2-AAE2
40166176NI	KBL2-4-AAG2-1	410.4	110	3/8" Tube OD	K2-AAG2
40166478DG	KBL3-4-AAD1-1	50.4	100	3/8" Tube OD	K3-AAD1
40166479DG	KBL3-4-AAE2-1	112.8	100	3/8" Tube OD	K3-AAE2
40166480NI	KBL3-4-AAG2-1	453.6	110	3/8" Tube OD	K3-AAG2
40166482DG	KBL3-4-AAK1-1	796.8	100	3/8" Tube OD	K3-AAK1
40166482Z1	KBL3-4-AAKL-1	796.8	30	3/8" Tube OD	K3-AAKL
40166983DG	KBL4-4-AAH1-1	681.6	100	1/2" NPT(M)	K4-AAH1
40166984DG	KBL4-4-AAH2-1	1288.8	100	1/2" NPT(M)	K4-AAH2
40166988BC	KBL4-4-AAL1-1	2388	50	1/2" NPT(M)	K4-AAL1
40166989Z1	KBL4-4-AAP1-1	3804	30	1/2" NPT(M)	K4-AAP1

REPLACEMENT PARTS & ACCESSORIES

C&M PART #	MFG PART #	DESCRIPTION
LMI® XL TUBE ASSEMBLIES		
401736	K2-AAD1	1/2" NPT(M) and 3/8" Tube Compression, 0.075" ID
401737	K2-AAE2	1/2" NPT(M) and 3/8" Tube Compression, 0.125" ID Twin
401738	K2-AAG2	1/2" NPT(M) and 3/8" Tube Compression, 0.187" ID Twin
401739	K3-AAD1	1/2" NPT(M) and 3/8" Tube Compression, 0.075" ID
401740	K3-AAE2	1/2" NPT(M) and 3/8" Tube Compression, 0.125" ID Twin
401741	K3-AAG2	1/2" NPT(M) and 3/8" Tube Compression, 0.187" ID Twin
401742	K3-AAK1	1/2" NPT(M) and 3/8" Tube Compression, 0.375" ID
401743	K4-AAH1	1/2" NPT(M), 0.25" ID
401744	K4-AAH2	1/2" NPT(M), 0.25" ID Twin
401745	K4-AAL1	1/2" NPT(M), 0.5" ID
401746	K4-AAP1	1/2" NPT(M), 0.75" ID
INSTALLATION KIT		
401751	KS-INSKIT	Includes Suction/Discharge Tubing, Suction Strainer, and Injection Fitting
LMI® ROTOR ASSEMBLIES—INCLUDES SPACER BUSHINGS		
401752	K2-R-A	For K2, AD1 Tubes
401753	K2-R-B	For K2, BH1 Tubes
401754	K2-R-C	For K2, CG1 and CG2 Tubes
401755	K2-R-D	For K2, AE2 and AG2 Tubes
401756	K3-R-A	For K3, AD1 Tubes
401757	K3-R-B	For K3, KL Tubes
401758	K3-R-C	For K3, CG1, CG2, CK1 Tubes
401759	K3-R-D	For K3, AE2, AG2, AK1 and BK1 Tubes
401760	K4-R-A	For K4, AH1 and AH2 Tubes
401761	K4-R-B	For K4, BH1 and BH2 Tubes
401762	K4-R-C	For K4, CH1, CK1, CK2 Tubes
401763	K4-R-D	For K4, AL1 and AP1 Tubes



LMI EXCEL™ Digital AD Series Chemical Feed Diaphragm Pumps

The Excel AD Series Pumps are designed to meet your most challenging needs. Pumps feature an advanced graphical LCD display that shows stroke speed, pump status and setup menus. Display can be set up to show theoretical flow rate, an approximation based on stroke and speed. All models allow manual stroke length and stroke frequency adjustments and feature low level indicator.

Select AD8 and AD9 Series for more advance features such as pulse or 4 to 20 mA input, 24 V output, pulse multiply/divide and dual-level float switch. Additionally, AD9 models come with remote on/off signal input, 4 to 20 mA, pulse, or alarm outputs, 7-day programmable timer and more. Interface with SCADA or PLC system as pump can be set in internal or external mode.

INCLUDES

General Chemical, Chlorine, and Fluoride Pumps: injection and suction valve, control cables (AD8 & AD9 only), 4 function valve, foot valve/strainer and 16-ft L polyethylene tubing

Polymer Pumps: injection and suction valve, control cables (AD8 & AD9 only), discharge valve, 3.5-ft L vinyl tubing and 10-ft L polyethylene tubing

General Chemical, Chlorine, and Fluoride Repair Kits: diaphragm, check balls, cartridge valve assemblies, valve seats and O-rings

Polymer Pump Repair Kits: diaphragm, check balls, seal rings and springs



SPECIFICATIONS

PUMP TYPE	GENERAL, CHLORINE, PVC & FLUORIDE	POLYMER
MAXIMUM VISCOSITY (cP)	200	40,000
SUCTION LIFT (ft)	5	3-1/2
TURNDOWN RATIO	1000:1	
ACCURACY	±2%	
INPUT	AD2 Pumps: Low-Level Float Switch Input AD8 Pumps: Dual-Level Float Switch Input, 4 to 20 mA and Pulse AD9 Pumps: Dual-Level Float Switch Input, 4 to 20mA, Pulse, remote on/off	
POWER	110/240 VAC	

CERTIFICATIONS

- NSF/ANSI 61 Certified, NSF 372 Certified

C&M PART #	MFG PART #	MAX FLOW (GPD)	MAX PRESSURE (PSI)	CONNECTION (OD TUBE)*	REPAIR KIT
GENERAL CHEMICAL PUMPS WITH FASTPRIME HEAD, PVDF HEAD/FITTINGS, CERAMIC CHECK BALLS, FLUOROFILM™ DIAPHRAGM, PTFE SEAT & O-RINGS					
10697611Q3EP	AD241-823SI	12	250	1/4"	RPM-823
10697617X1NI	AD251-833SI	24	110	3/8"	RPM-833
10697617AZBC	AD261-843SI	48	50	3/8"	RPM-843
10697911Q3EP	AD841-823SI	12	250	1/4"	RPM-823
10697917X1NI	AD851-833SI	24	110	3/8"	RPM-833
10697917AZBC	AD861-843SI	48	50	3/8"	RPM-843
10698211Q3EP	AD941-823SI	12	250	1/4"	RPM-823
10698217X1NI	AD951-833SI	24	110	3/8"	RPM-833
10698217AZBC	AD961-843SI	48	50	3/8"	RPM-843
GENERAL CHEMICAL PUMPS WITH FASTPRIME HEAD, PVC HEAD/FITTINGS, CERAMIC CHECK BALLS, FLUOROFILM DIAPHRAGM, PTFE/POLYPREL SEAT & O-RINGS					
10710011Q3EP	AD241-828SI	12	250	1/4"	RPM-823
10710017X1NI	AD251-838SI	24	110	3/8"	RPM-833
10710017AZBC	AD261-848SI	48	50	3/8"	RPM-843
10710311Q3EP	AD841-828SI	12	250	1/4"	RPM-823
10710317X1NI	AD851-838SI	24	110	3/8"	RPM-833
10710317AZBC	AD861-848SI	48	50	3/8"	RPM-843
10710611Q3EP	AD941-828SI	12	250	1/4"	RPM-823
10710617X1NI	AD951-838SI	24	110	3/8"	RPM-833
10710617AZBC	AD961-848SI	48	50	3/8"	RPM-843

*1/2" NPT(M) threads for hard piping revealed when connecting nut is removed.

C&M PART #	MFG PART #	MAX FLOW (GPD)	MAX PRESSURE (PSI)	CONNECTION (OD TUBE)*	REPAIR KIT
GENERAL CHEMICAL PUMPS WITH AUTOPRIME HEAD, PVC HEAD/FITTINGS, CERAMIC CHECK BALLS, FLUOROFILM DIAPHRAGM, PTFE SEAT & O-RINGS					
10710911C5EP	AD241-A28AI	7.9	250	1/4"	RPM-A20A
10710917MBNI	AD251-A38AI	19.2	110	3/8"	RPM-A30A
10710917MKBC	AD261-A48AI	43.2	50	3/8"	RPM-A40A
10711211C5EP	AD841-A28AI	7.9	250	1/4"	RPM-A20A
10711217MBNI	AD851-A38AI	19.2	110	3/8"	RPM-A30A
10711217MKBC	AD861-A48AI	43.2	50	3/8"	RPM-A40A
10711511C5EP	AD941-A28AI	7.9	250	1/4"	RPM-A20A
10711517MBNI	AD951-A38AI	19.2	110	3/8"	RPM-A30A
10711517MKBC	AD961-A48AI	43.2	50	3/8"	RPM-A40A
CHLORINE PUMPS WITH AUTOPRIME HEAD, ACRYLIC HEAD, PVC FITTINGS, CERAMIC CHECK BALLS, FLUOROFILM DIAPHRAGM, POLYPREL SEALS					
10698811C5EP	AD241-A20HI	7.9	250	1/4"	RPM-A20A
10698817MBNI	AD251-A30HI	19.2	110	3/8"	RPM-A30A
10698817MKBC	AD261-A40HI	43.2	50	3/8"	RPM-A40A
10699111C5EP	AD841-A20HI	7.9	250	1/4"	RPM-A20A
10699117MBNI	AD851-A30HI	19.2	110	3/8"	RPM-A30A
10699117MKBC	AD861-A40HI	43.2	50	3/8"	RPM-A40A
10699411C5EP	AD941-A20HI	7.9	250	1/4"	RPM-A20A
10699417MBNI	AD951-A30HI	19.2	110	3/8"	RPM-A30A
10699417MKBC	AD961-A40HI	43.2	50	3/8"	RPM-A40A

*1/2" NPT(M) threads for hard piping revealed when connecting nut is removed.

Continued on Next Page

LMI EXCEL™ Digital AD Series Chemical Feed Diaphragm Pumps (continued)

C&M PART #	MFG PART #	MAX FLOW (GPD)	MAX PRESSURE (PSI)	CONNECTION (OD TUBE)*	REPAIR KIT
FLUORIDE PUMPS WITH FASTPRIME HEAD, ACRYLIC HEAD, PVDF FITTINGS, PTFE CHECK BALLS, FLUOROFILM DIAPHRAGM, POLYPREL SEALS					
10699711F9EP	AD211-919SI	5	250	1/4"	RPM-919
10699711Q3EP	AD241-929SI	12	250	1/4"	RPM-929
10699717X1NI	AD251-939SI	24	110	3/8"	RPM-939
10699717AZBC	AD261-949SI	48	50	3/8"	RPM-949
10700111F9EP	AD811-919SI	5	250	1/4"	RPM-919
10700111Q3EP	AD841-929SI	12	250	1/4"	RPM-929
10700117X1NI	AD851-939SI	24	110	3/8"	RPM-939
10700117AZBC	AD861-949SI	48	50	3/8"	RPM-949
10700511Q3EP	AD941-929SI	12	250	1/4"	RPM-929
10700517X1NI	AD951-939SI	24	110	3/8"	RPM-939
10700517AZBC	AD961-949SI	48	50	3/8"	RPM-949

*1/2" NPT(M) threads for hard piping revealed when connecting nut is removed.

C&M PART #	MFG PART #	MAX FLOW (GPD)	MAX PRESSURE (PSI)	CONNECTION (OD TUBE)*	REPAIR KIT
POLYMER PUMPS WITH HIGH-VISCOSITY HEAD, POLYPROPYLENE HEAD/FITTINGS, 316 SS CHECK BALLS, FLUOROFILM DIAPHRAGM, PTFE CHECK VALVES					
10701219Q3EP	AD241-624VI	12	250	1/2"	RPM-624
10701219X1NI	AD251-634VI	24	110	1/2"	RPM-634
10701419Q3EP	AD841-624VI	12	250	1/2"	RPM-624
10701419X1NI	AD851-634VI	24	110	1/2"	RPM-634
10701619Q3EP	AD941-624VI	12	250	1/2"	RPM-624
10701619X1NI	AD951-634VI	24	110	1/2"	RPM-634

*1/2" NPT(M) threads for hard piping revealed when connecting nut is removed.

HDPE NSF-61 TUBING

C&M PART #	MFG PART #	COLOR	ID x OD	QTY
1113591711BC	0170-0250-040-23-13-00050	Black	1/6" x 1/4"	50 ft roll
1113591811X2	0170-0250-040-23-03-00025	Translucent	1/6" x 1/4"	25 ft Roll
1113591717X2	0250-0375-062-23-13-00025	Black	1/4" x 3/8"	25 ft Roll
1113591817X2	0250-0375-062-23-03-00025	Translucent	1/4" x 3/8"	25 ft Roll
1113591819X2	0375-0500-062-23-03-00025	Translucent	3/8" x 1/2"	25 ft Roll

*See 43 for Repair Kits

LMI Excel XR Series Chemical Feed Diaphragm Pumps

The Excel XR Series Chemical Feed Pumps feature a stepper motor drive which delivers a smooth and accurate chemical feed output and eliminates air lock caused by gaseous chemicals like sodium hypochlorite. Pumps come with a four-color backlit display, feature simple push-button operation, and accept remote start/stop or single level float switch control input. Select from manual control pumps with standard features or enhanced control pumps with extra input/output capabilities.

INCLUDES

3/8" OD Tube Connection Pumps: injection valve, foot valve, ceramic foot valve weight, 16-ft L polyethylene tubing, 20-ft L reinforced PVC hose, 4, 5 and 6-pin external control cables (enhanced control pumps only)

1/2" Connection Pumps: no accessories included except for the enhanced models, which include control cables

Repair Kits: diaphragm, secondary diaphragm housing seal, O-rings and replaceable check valve

SPECIFICATIONS

MAX VISCOSITY (cP)	50
SUCTION LIFT (ft)	134.4 and 336 GPD pumps: 13.1 432GPD pumps: 6.5
TURNDOWN RATIO	General Pumps: 1000:1 Chlorine Pumps: 200:1
ACCURACY	±1%
INPUT	Manual Control: Single-Level Float Switch, Remote Start/Stop Enhanced Control: Single-Level Float Switch, Dual Low-Level Float Switch, Remote Start/Stop, 4 to 20 mA and Pulse
OUTPUT	Manual Control: None Enhanced Control: 2 Programmable Digital Contacts, 1 Programmable Analog Output, 24 V Power Supply for Remote Device
POWER	110/120 VAC



CERTIFICATIONS

- NSF/ANSI 61 Certified, NSF 372 Certified

C&M PART #	MFG PART #	MAX FLOW (GPD)	MAX PRESSURE (PSI)	CONNECTION (TUBE OD)*	REPAIR KIT
GENERAL MANUAL CONTROL PUMPS					
10704717MQNK	XRD121-A44ACA7T1	134.4	175	3/8"	RPM54771
10704717MUCG	XRD131-A44ACA7T1	336	75	3/8"	RPM54771
10704719MWBC	XRD141-A46VCN4PN	432	50	1/2"	RPM54780
GENERAL ENHANCED CONTROL PUMPS					
10705017MQNK	XRD921-A44ACA7T1	134.4	175	3/8"	RPM54771
10705017MUCG	XRD931-A44ACA7T1	336	75	3/8"	RPM54771
10705019MWBC	XRD941-A46VCN4PN	432	50	1/2"	RPM54780
CHLORINE MANUAL CONTROL PUMPS					
10705517MQNK	XRD121-A74TCA7T1	134.4	175	3/8"	RPM54773
10705517MUCG	XRD131-A74TCA7T1	336	75	3/8"	RPM54773
10705519MWBC	XRD141-A76VCN7PN	432	50	1/2"	RPM54780
CHLORINE ENHANCED CONTROL PUMPS					
10705817MQNK	XRD921-A74TCA7T1	134.4	175	3/8"	RPM54773
10705817MUCG	XRD931-A74TCA7T1	336	75	3/8"	RPM54773
10705819MWBC	XRD941-A76VCN7PN	432	50	1/2"	RPM54780

*Pumps with 3/8" connections use 1/4" ID x 1/2" OD reinforced PVC on the suction side

LMI B9 & C9 Series Chemical Feed Diaphragm Pumps



The B9 & C9 Series Chemical Feed Pumps feature microprocessor control for accurate and flexible automated system for your pumps. An LCD and a tactile response keypad makes for easy programming. Pumps feature 4 to 20 mA, pulse signal, remote on/off and low-level shutoff inputs. Control the pump speed using the keypad or manually using the dial; adjust speed from 1 stroke/hour to 100 strokes/minute. Two pulse modes, pulse divide and pulse multiply, let you program the pump to stroke for every incoming pulse signal. Select pumps with AutoPrime™ head for chemicals that off-gas such as sodium hypochlorite in a suction lift configuration. Not for use in flooded suction applications.

INCLUDES

General, Chlorine and Fluoride Pumps: injection valve, suction valve, 4-function valve, foot valve with strainer and 16-ft L polyethylene tubing

Polymer Pumps: injection valve, suction valve, discharge valve, 3.5-ft L vinyl tubing and 10-ft L polyethylene tubing

General, Chlorine and Fluoride Repair Kits: diaphragm, check balls, cartridge valve assemblies, valve seats and O-rings

Polymer Repair Kits: diaphragm, check balls, seal rings and springs

SPECIFICATIONS

PUMP TYPE	GENERAL, CHLORINE & FLUORIDE	POLYMER
MAX VISCOSITY (cP)	200 cP	40,000 cP
SUCTION LIFT (ft)	5	3-1/2
TURNDOWN RATIO	1000:1	
ACCURACY	±2%	
INPUT	Wet contact closure for remote start/stop, low-level float switch input, 4 to 20 mA and pulse	
OUTPUT	Pulse, Alarm	
POWER	110/240 VAC	

CERTIFICATIONS

- NSF/ANSI 61 Certified, NSF 372 Certified

C&M PART #	MFG PART #	MAX FLOW (GPD)	MAX PRESSURE (PSI)	CONNECTION*	REPAIR KIT
GENERAL PUMPS WITH LIQUIPRO HEAD					
10695317MHED	B911-393SI	38.4	150	3/8"	RPM-393
10695317BRED	C911-363SI	60	150	3/8"	RPM-363
10695317BRDG	B921-393SI	60	100	3/8"	RPM-393
10695817DCDG	C921-363SI	96	100	3/8"	RPM-363
10695317MPBC	B931-363SI	108	50	3/8"	RPM-363
10695317EIZ1	B941-313SI	168	30	1/2"	RPM-313
10695817MSBR	C931-313SI	192	60	1/2"	RPM-313
GENERAL PUMPS WITH AUTOPRIME HEAD					
10696017MGED	B911-D90HI	33.6	150	3/8"	RPM-D98
10696317MMED	C911-D60HI	55.2	150	3/8"	RPM-D68
10696017MMDG	B921-D90HI	55.2	100	3/8"	RPM-D98
10696317MODG	C921-D60HI	91.2	100	3/8"	RPM-D68
10696017DCBC	B931-D60HI	96	50	3/8"	RPM-D68
CHLORINE PUMPS WITH LIQUIPRO HEAD					
10708717MHED	B911-398SI	38.4	150	3/8"	RPM-392
10708717BRED	C911-368SI	60	150	3/8"	RPM-362
10708717BRBR	B921-398SI	60	100	3/8"	RPM-392
10709217DCDG	C921-368SI	96	100	3/8"	RPM-362
10708717MPBC	B931-368SI	108	50	3/8"	RPM-362
10708717EIZ1	B941-318SI	168	30	3/8"	RPM-312
10709217MSBR	C931-318SI	192	60	3/8"	RPM-312
CHLORINE PUMPS WITH AUTOPRIME HEAD					
10709417MGED	B911-D98AI	38.4	150	3/8"	RPM-D98
10709717MMED	C911-D68AI	60	150	3/8"	RPM-D68
10709417MMDG	B921-D98AI	60	100	3/8"	RPM-D98
10709717MODG	C921-D68AI	96	100	3/8"	RPM-D68
10709417DCBC	B931-D68AI	108	50	3/8"	RPM-D68
10709719MSBR	C931-D18AI	192	60	3/8"	RPM-D18
FLUORIDE PUMPS WITH LIQUIPRO HEAD					
10696717MODG	B911-499SI	38.4	150	3/8"	RPM-490F
10696717MONH	B921-499SI	60	100	3/8"	RPM-490F
10696917QGDD	C921-469SI	96	100	3/8"	RPM-460F
POLYMER PUMPS WITH HIGH-VISCOSITY HEAD+					
10697219MHED	B911-85HV	38.4	150	1/2"	SP-85HV
10697219BRDG	B921-85HV	60	100	1/2"	SP-85HV
10697419DCDG	C921-75HV	96	100	1/2"	SP-75HV
10697419BRBR	C931-25HV	192	60	1/2"	SP-25HV

*1/2" NPT(M) threads for hard piping revealed when connecting nut is removed.

+Not certified by NSF.

**0.938" OD tubing used on suction side of pump.

LMI B7 & C7 Chemical Feed Diaphragm Pumps



The B7 and C7 Series Chemical Feed Pumps provide highly accurate and consistent dosing performance and adjustable stroke frequency, making them ideal for municipal applications. Simply adjust the stroke length and frequency using two dials. Remotely control pump stroke rate with a pulse input signal; pumps also accept remote on/off contact closure signal. Low level shut-off feature shuts off the pump when process flow is interrupted, or day tank reaches low levels.

FEATURES & BENEFITS

- Manually adjustable stroke length provides accurate pump output adjustment
- Rugged NEMA 4X/IP65 enclosures for protection against corrosive environments
- Optional AutoPrime™ liquid ends designed specifically for off-gassing liquids like sodium hypochlorite
- All models (except high-viscosity pumps and where noted) include 4-function discharge valve (4FV, anti-siphon/pressure relief valve)

INCLUDES

All pumps include injection valve, suction valve, 4-function valve (except high-viscosity pumps and where noted), foot valve/strainer and 16-ft L polyethylene tubing

Polymer pumps (high-viscosity liquid end) also include discharge valve, 3-1/2 ft L vinyl tubing and 10-ft L polyethylene tubing

SPECIFICATIONS

PUMP TYPE	GENERAL, CHLORINE & FLUORIDE PUMPS	HIGH-VISCOSITY, POLYMER PUMPS
ACCURACY	±2%	
SUCTION LIFT (ft)	5	3-1/2
MAX VISCOSITY (cP)	200	40,000
TURNDOWN RATIO	500:1	
POWER	110/240 VAC, Single Phase	
INPUT	Manual or Automatic Control Via Pulse Input Signal, Remote On/Off, Low-Level Shutoff	

CERTIFICATIONS

- UL, cUL, NSF certified to NSF/ANSI 61 & 372, Standard 50

HDPE NSF-61 TUBING

C&M PART #	MFG PART #	COLOR	ID x OD	QTY
1113591811X2	0170-0250-040-23-03-00025	Translucent	1/6" x 1/4"	25 ft Roll
1113591717X2	0250-0375-062-23-13-00025	Black	1/4" x 3/8"	25 ft Roll
1113591817X2	0250-0375-062-23-03-00025	Translucent	1/4" x 3/8"	25 ft Roll
1113591819X2	0375-0500-062-23-03-00025	Translucent	3/8" x 1/2"	25 ft Roll

C&M PART #	MFG PART #	FLOW MAX (GPD)	PRESSURE MAX (PSI)	CONNECTION (TUBE OD)*	REPAIR KIT
GENERAL PUMPS: LiquiPro liquid end, acrylic pump head, PVC fittings, ceramic check balls, Fluorofilm™ diaphragm, PVDF check valves, Polyprel® seals					
10691317MHED	B711-490SI	38	150	3/8"	RPM-392
10691317BRDG	B721-490SI	60	100	3/8"	RPM-392
10691317MPBC	B731-460SI	108	50	3/8"	RPM-362
10691319EI1	B741-410SI	168	30	1/2"	RPM-312
10691717BRED	C711-460SI	60	150	3/8"	RPM-362
10691717DCDG	C721-460SI	96	100	3/8"	RPM-362
10691719MSBR	C731-410SI	192	60	1/2"	RPM-312
GENERAL PUMPS: Non-LiquiPro liquid end, acrylic pump head, PVC fittings, ceramic check balls, Fluorofilm diaphragm, PVDF check valves, Polyprel seals					
10692019MTCM	C771-20S (FKM seals)	240	80	1/2"	SP-20
10692019MXX2	C741-30 (no 4FV)	480	25	1/2"	SP-U6
10692019FGZ1	C781-30 (no 4FV)	600	30	1/2"	SP-U6
GENERAL PUMPS: LiquiPro liquid end, PVDF pump head/fittings, ceramic check balls, Fluorofilm diaphragm, PVDF check valves, PTFE seals—can be used with peracetic acid					
10692517MHED	B711-393SI	38	150	3/8"	RPM-393
10692517BRDG	B721-393SI	60	100	3/8"	RPM-393
10692517MPBC	B731-363SI	108	50	3/8"	RPM-363
10692519QFZ1	B741-313SI	168	30	1/2"	RPM-313
10692917BRED	C711-363SI	60	150	3/8"	RPM-363
10692917DCDG	C721-363SI	96	100	3/8"	RPM-363
10692919MSBR	C731-313SI	192	60	1/2"	RPM-313
GENERAL PUMPS: Non-LiquiPro liquid end, PVDF pump head/fittings, ceramic check balls, Fluorofilm diaphragm, PVDF check valves, PTFE seals—NOT for use with peracetic acid					
10693319MTCM	C771-26S (FKM seals)	240	80	1/2"	SP-26
10693319MXX2	C741-36 (no 4FV)	480	25	1/2"	SP-U6
10693319FGZ1	C781-36 (no 4FV)	600	30	1/2"	SP-U6
FLUORIDE PUMPS: LiquiPro liquid end, acrylic head, PVDF fittings, PTFE check balls, Fluorofilm diaphragm, PVDF check valves, Polyprel seals—can be used with fluoride and hydrofluorosilicic acid					
10694217MHED	B711-499SI	38	150	3/8"	RPM-490F
10694217BRDG	B721-499SI	60	100	3/8"	RPM-490F
10694217DCED	C721-469SI	96	100	3/8"	RPM-460F
10694219MSCM	C731-419SI	192	60	1/2"	RPM-410F
SODIUM HYPOCHLORITE PUMPS: AutoPrime™ liquid end, acrylic pump head, PVC fittings, ceramic check balls, Fluorofilm diaphragm, PVDF check valves, Polyprel seals—can be used with sodium hypochlorite (not for use in flooded suction applications; use pumps with FastPrime™ liquid end for flooded suction applications)					
10693717MGED	B711-D90HI	30	150	3/8"	RPM-D98
10693717MMDG	B721-D90HI	48	100	3/8"	RPM-D98
10693717DCBC	B731-D60HI	84	50	3/8"	RPM-D68
10694017MMED	C711-D60HI	48	150	3/8"	RPM-D68
10694017MODG	C721-D60HI	60	100	3/8"	RPM-D68
POLYMER PUMPS: High-Viscosity liquid end, PP pump head/fittings, 316 SS check balls, Fluorofilm diaphragm PTFE check valves/seals, hose barb suction side, OD Tube connection discharge side—can be used with polymer and aluminum sulfate (alum)					
10694619MHED	B711-85HV	38	150	1/2"	SP-85HV
10694619BRDG	B721-85HV	60	100	1/2"	SP-85HV
10694819DCED	C721-75HV	96	100	1/2"	SP-75HV
10694819MTCM	C771-25HV	240	80	1/2"	SP-25HV

*1/2" NPT(M) threads for hard piping revealed when connecting nut is removed.



LMI B1 & C1 Chemical Feed Diaphragm Pumps



The B1 and C1 Series Chemical Feed Pumps provide highly accurate and consistent dosing performance and adjustable stroke frequency, making them ideal for municipal applications. Simply adjust the stroke length and frequency using two dials.

FEATURES & BENEFITS

- Manually adjustable stroke length provides accurate pump output adjustment
- Rugged NEMA 4X/IP65 enclosures for protection against corrosive environments
- Optional AutoPrime™ liquid ends designed specifically for off-gassing liquids like sodium hypochlorite
- All models (except high-viscosity pumps) include 4-function discharge valve

INCLUDES

All pumps include injection valve, suction valve, 4-function valve, foot valve/strainer and 16-ft L polyethylene tubing

Polymer pumps (high-viscosity liquid end) also include discharge valve, 3-1/2 ft L vinyl tubing and 10-ft L polyethylene tubing

SPECIFICATIONS

PUMP TYPE	GENERAL, CHLORINE & FLUORIDE PUMPS	POLYMER PUMPS
ACCURACY	±2%	
SUCTION LIFT (ft)	5	3-1/2
MAX VISCOSITY (cP)	200	40,000
TURNDOWN RATIO	100:1	
POWER	110/240 VAC, Single Phase	

CERTIFICATIONS

- UL, cUL, NSF certified to NSF/ANSI 61 & 372, Standard 50

Note: Polyprel® NOT tested by manufacturer for use with peracetic acid

HDPE NSF-61 TUBING

C&M PART #	MFG PART #	COLOR	ID x OD	QTY
1113591711BC	0170-0250-040-23-13-00050	Black	1/6" x 1/4"	50 ft Roll
1113591811X2	0170-0250-040-23-03-00025	Translucent	1/6" x 1/4"	25 ft Roll
1113591717X2	0250-0375-062-23-13-00025	Black	1/4" x 3/8"	25 ft Roll
1113591817X2	0250-0375-062-23-03-00025	Translucent	1/4" x 3/8"	25 ft Roll
1113591819X2	0375-0500-062-23-03-00025	Translucent	3/8" x 1/2"	25 ft Roll

C&M PART #	MFG PART #	MAX FLOW (GPD)	MAX PRESSURE (PSI)	CONNECTION (TUBE OD)*	REPAIR KIT
GENERAL PUMPS: LiquiPro liquid end, PVC pump head/fittings, ceramic check balls, Fluorofilm™ diaphragm, PVDF check valves, Polyprel® seals					
10707417MHED	B111-398SI	38.4	150	3/8"	RPM-398
10707417BRDG	B121-398SI	60	100	3/8"	RPM-398
10707417MPBC	B131-368SI	108	50	3/8"	RPM-368
10707419EIZ1	B141-318SI	168	30	1/2"	—
10707817BRED	C111-368SI	60	150	3/8"	RPM-368
10707817DCDG	C121-368SI	96	100	3/8"	RPM-368
10707819MSBR	C131-318SI	192	60	1/2"	RPM-318
GENERAL PUMPS: LiquiPro liquid end, PVDF pump head/fittings, ceramic check balls, Fluorofilm diaphragm, PVDF check valves, PTFE seals					
10688117MHED	B111-393SI	38.4	150	3/8"	RPM-393
10688117BRDG	B121-393SI	60	100	3/8"	RPM-393
10688117MPBC	B131-363SI	108	50	3/8"	RPM-363
10688119EIZ1	B141-313SI	168	30	1/2"	RPM-313
10688517BRED	C111-363SI	60	150	3/8"	RPM-363
10688517DCDG	C121-363SI	96	100	3/8"	RPM-363
10688519MSBR	C131-313SI	192	60	1/2"	RPM-313
FLUORIDE PUMPS: LiquiPro liquid end, acrylic pump head, PVDF fittings, ceramic check balls, Fluorofilm diaphragm, PVDF check valves, Polyprel seals—can be used with fluoride and hydrofluorosilicic acid					
10690017MHED	B111-499SI	38.4	150	3/8"	RPM-490F
10690017BRDG	B121-499SI	60	100	3/8"	RPM-490F
10690217BRED	C121-469SI	96	100	3/8"	RPM-460F
10690217MSBR	C131-419SI	192	60	1/2"	RPM-410F
SODIUM HYPOCHLORITE PUMPS: AutoPrime™ liquid end, PVC pump head/fittings, ceramic check balls, Fluorofilm diaphragm, Polyprel check valves/seals—can be used with sodium hypochlorite (not for use in flooded suction applications; use pumps with FastPrime™ liquid end for flooded suction applications)					
10708119MSBR	B111-D98AI	33.6	150	3/8"	RPM-D98
10708119QBBS	B121-D98AI	55.2	100	3/8"	RPM-D98
10708119QCBT	B131-D68AI	96	50	3/8"	RPM-D68
10708419QDBU	C111-D68AI	55.2	150	3/8"	RPM-D68
10708419QEBV	C121-D68AI	91.2	100	3/8"	RPM-D68
SODIUM HYPOCHLORITE PUMPS: AutoPrime liquid end, acrylic pump head, PVC fittings, ceramic check balls, Fluorofilm diaphragm, PVDF check valves, Polyprel seals—can be used with sodium hypochlorite (not for use in flooded suction applications; use pumps with FastPrime liquid end for flooded suction applications)					
10689319MSBR	B111-D90HI	33.6	150	3/8"	RPM-D98
10689319QBBS	B121-D90HI	55.2	100	3/8"	RPM-D98
10689319QCBT	B131-D60HI	96	50	3/8"	RPM-D68
10689619QDBU	C111-D60HI	55.2	150	3/8"	RPM-D68
10689619QEBV	C121-D60HI	91.2	100	3/8"	RPM-D68
POLYMER PUMPS: High-viscosity liquid end, PP pump head/fittings, 316 SS check balls, Fluorofilm diaphragm PTFE check valves/seals, hose barb suction side, OD Tube connection discharge side—can be used with polymer and aluminum sulfate (alum)					
10690619MHED	B111-85HV	38.4	150	1/2"	SP-85HV
10690619BRDG	B121-85HV	60	100	1/2"	SP-85HV
10690819DCDG	C121-75HV	96	100	1/2"	SP-75HV

*1/2" NPT(M) threads for hard piping revealed when connecting nut is removed.

LMI PD7 Enhanced Control Chemical Feed Diaphragm Pumps

The PD Series Enhanced Control Chemical Metering Pumps fit seamlessly into your process control application. Upgraded features to LMI's most popular pump series includes an improved drive design, all new electronics, and proven FASTPRIME™ liquid ends. External control inputs provide convenient remote access to automate your process. A large 2.4" color graphical LCD display provides intuitive access to advanced features such as calibration assist, system and user totalizers and the new STAYPRIME™ degassing technology. Improved drive mechanism provides more powerful stroke, consistent steady state accuracy and reliable efficiency. Simplified capacity control with constant stroke length helps maintain calibration across the adjustable range.



FEATURES & BENEFITS

- Calibration assist offers easy calibration process
- System & User Totalizers allows pump operation confirmation between visits
- Advanced electronics with dynamic compensation for temperature and voltage conditions
- FastPrime™ liquid ends models allow fast and easy priming with integrated bleed valve
- AutoPrime™ liquid ends models are designed specifically for off-gassing liquids
- Rugged NEMA 4X/IP 65 housing for the harshest environments and outdoor use
- Compact footprint for efficient use of space in process applications

INCLUDES

4-function valve, injection valve, suction valve, foot valve/strainer and 16 ft L polyethylene tubing

SPECIFICATIONS

ACCURACY	±3%
SUCTION LIFT (ft)	5
MAX VISCOSITY (cP)	200
TURNDOWN RATIO	200:1
POWER	110/240 VAC, Single Phase
INPUT	Pulse Input, Remote Start/Stop, Tank Level Indication

CERTIFICATIONS

- NSF 61 and 50 (pending), ETL, CE

C&M PART #	MFG PART #	MAX FLOW (GPD)	MAX PRESSURE (PSI)	CONNECTION, (TUBE OD)	REPAIR KITS
GENERAL PUMPS: FastPrime™ liquid end, PVC pump head/fittings, ceramic check balls, PTFE seat, Polypropel® O-Rings					
10706511MAEP	PD741-828SI	16.3	250	1/4"	RPM-828
10706517MENI	PD751-838SI	26.4	110	3/8"	RPM-838
10706517AZCB	PD761-848SI	48	70	3/8"	RPM-848
GENERAL PUMPS: FastPrime liquid end, PVDF pump head/fittings, ceramic check balls, PTFE seat, Polypropel O-Rings					
10685411MAEP	PD741-822SI	16.3	250	1/4"	RPM-822
10685417MENI	PD751-832SI	26.4	110	3/8"	RPM-832
10685417AZCB	PD761-842SI	48	70	3/8"	RPM-842
FLUORIDE PUMPS: FastPrime liquid end, acrylic pump head, PVDF fittings, PTFE check balls, Fluorofilm diaphragm, Polypropel seat/O-Rings—can be used with fluoride and hydrofluorosilicic acid					
10687211MAEP	PD741-929SI	16.3	250	1/4"	RPM-929
10687217MEED	PD751-939SI	26.4	150	3/8"	RPM-939
10687217AZCB	PD761-949SI	48	70	3/8"	RPM-949
SODIUM HYPOCHLORITE PUMPS: AutoPrime™ liquid end, PVC pump head/fittings, ceramic check balls, PTFE seat, Polypropel O-Rings—can be used with sodium hypochlorite (not for use in flooded suction applications; use pumps with FastPrime liquid end for flooded suction applications)					
10707111JPEP	PD741-A28AI	4.8	250	1/4"	RPM-A20A
10707117U5NI	PD751-A38AI	18	110	3/8"	RPM-A30A
10707117APBC	PD761-A48AI	42	50	3/8"	RPM-A40A
SODIUM HYPOCHLORITE PUMPS: AutoPrime liquid end, acrylic pump head, PVC fittings, ceramic check balls, PTFE seat, Polypropel O-Rings—can be used with sodium hypochlorite (not for use in flooded suction applications; use pumps with FastPrime liquid end for flooded suction applications)					
10686311JPEP	PD741-A20HI	4.8	250	1/4"	RPM-A20A
10686317U5NI	PD751-A30HI	18	110	3/8"	RPM-A30A
10686317APBC	PD761-A40HI	42	50	3/8"	RPM-A40A

HDPE NSF-61 TUBING

C&M PART #	MFG PART #	COLOR	ID x OD	QTY
1113591711BC	0170-0250-040-23-13-00050	Black	1/6" x 1/4"	50 ft Roll
1113591811X2	0170-0250-040-23-03-00025	Translucent	1/6" x 1/4"	25 ft Roll
1113591717X2	0250-0375-062-23-13-00025	Black	1/4" x 3/8"	25 ft Roll
1113591817X2	0250-0375-062-23-03-00025	Translucent	1/4" x 3/8"	25 ft Roll
1113591819X2	0375-0500-062-23-03-00025	Translucent	3/8" x 1/2"	25 ft Roll

LMI RPM REPAIR KITS

See **page 43** for Repair & Preventative Maintenance Kits for LMI Pumps.



LMI PDO Manual Control Chemical Feed Diaphragm Pumps

The PDO Series Manual Control Chemical Feed Pumps are designed specifically for industrial water treatment applications. Simple straightforward controls without the need for tedious calculations make these very easy to use. The split-scale dial ensures precision, even at lower flow rates. Improved drive mechanism provides more powerful stroke, consistent steady state accuracy and reliable efficiency. Simplified capacity control with constant stroke length helps maintain calibration across the adjustable range.



FEATURES & BENEFITS

- Advanced electronics with dynamic compensation for temperature and voltage conditions
- FastPrime™ liquid ends models allow fast and easy priming with integrated bleed valve
- AutoPrime™ liquid ends models are designed specifically for off-gassing liquids
- Rugged NEMA 4X/IP 65 housing withstands the harshest environments and outdoor use
- Compact footprint for efficient use of space in process applications

INCLUDES

4-function valve, injection valve, suction valve, foot valve/strainer and 16 ft L polyethylene tubing

SPECIFICATIONS

ACCURACY	±3%
SUCTION LIFT (ft)	5
MAX VISCOSITY (cP)	200
TURNDOWN RATIO	200:1
POWER	110/240 VAC, Single Phase
INPUT	None

CERTIFICATIONS

- NSF 61 and 50 (pending), ETL, CE

C&M PART #	MFG PART #	MAX FLOW (GPD)	MAX PRESSURE (PSI)	CONNECTION, (TUBE OD)	REPAIR KIT
GENERAL PUMPS: FastPrime liquid end, PVC pump head/fittings, ceramic check balls, PTFE seat, Polyprel® O-Rings					
10706211MAEP	PD041-828SI	16.3	250	1/4"	RPM-828
10706217MENI	PD051-838SI	26.4	110	3/8"	RPM-838
10706217AZCB	PD061-848SI	48	70	3/8"	RPM-848
GENERAL PUMPS: FastPrime liquid end, PVDF pump head/fittings, ceramic check balls, PTFE seat, Polyprel O-Rings					
10685111MAEP	PD041-822SI	16.3	250	1/4"	RPM-822
10685117MENI	PD051-832SI	26.4	110	3/8"	RPM-832
10685117AZCB	PD061-842SI	48	70	3/8"	RPM842
FLUORIDE PUMPS: FastPrime liquid end, acrylic pump head, PVDF fittings, PTFE check balls, Fluorofilm diaphragm, Polyprel seat/O-Rings—can be used with fluoride and hydrofluorosilicic acid					
10686911MAEP	PD041-929SI	16.3	250	1/4"	RPM-929
10686917MEED	PD051-939SI	26.4	150	3/8"	RPM-939
10686917AZCB	PD061-949SI	48	70	3/8"	RPM-949
SODIUM HYPOCHLORITE PUMPS: AutoPrime liquid end, PVC pump head/fittings, ceramic check balls, PTFE seat, Polyprel O-Rings—can be used with sodium hypochlorite (not for use in flooded suction applications; use pumps with FastPrime liquid end for flooded suction applications)					
10706811JPEP	PD041-A28AI	4.8	250	1/4"	RPM-A20A
10706817U5NI	PD051-A38AI	18	110	3/8"	RPM-A30A
10706817APBC	PD061-A48AI	42	50	3/8"	RPM-A40A
SODIUM HYPOCHLORITE PUMPS: AutoPrime liquid end, acrylic pump head, PVC fittings, ceramic check balls, PTFE seat, Polyprel O-Rings—can be used with sodium hypochlorite (not for use in flooded suction applications; use pumps with FastPrime liquid end for flooded suction applications)					
10686011JPEP	PD041-A20HI	4.8	250	1/4"	RPM-A20A
10686017U5NI	PD051-A30HI	18	110	3/8"	RPM-A30A
10686017APBC	PD061-A40H	42	50	3/8"	RPM-A40A

HDPE NSF-61 TUBING

C&M PART #	MFG PART #	COLOR	ID x OD	QTY
1113591711BC	0170-0250-040-23-13-00050	Black	1/6" x 1/4"	50 ft Roll
1113591811X2	0170-0250-040-23-03-00025	Translucent	1/6" x 1/4"	25 ft Roll
1113591717X2	0250-0375-062-23-13-00025	Black	1/4" x 3/8"	25 ft Roll
1113591817X2	0250-0375-062-23-03-00025	Translucent	1/4" x 3/8"	25 ft Roll
1113591819X2	0375-0500-062-23-03-00025	Translucent	3/8" x 1/2"	25 ft Roll

SUGGESTED PRODUCTS

Thickster™ Latex Exam Grade Disposable Gloves

The Thickster Latex Exam Grade Disposable Gloves measure 14-mil thick offering excellent tear resistance. These extra thick and tough gloves feature a textured grip with a beaded cuff and are 12" long for added arm protection. Use these gloves for chemicals, janitorial, automotive, painting and plumbing applications.



FEATURES & BENEFITS

- Beaded cuff for easy wearing
- 12" L gloves offer additional arm protection
- 14-mil thick yet soft and flexible
- Single use only



SPECIFICATIONS

MATERIAL	Latex
POWDER CONTENT	Powdered
THICKNESS	14 mil

C&M PART #	MFG PART #	SIZE	QUANTITY/BOX
102264MD	6602-20	M	50
102264LG	6603-20	L	50
102264XL	6604-20	XL	50
1022642X	6605-20	2X	50

LMI RPM Repair Kits



Repair & Preventative Maintenance Kits for LMI Pumps.

C&M PART #	MFG PART #	FOR LIQUID END ASSEMBLY
LIQUIPRO™ RPM KITS		
106924	RPM-312/318	318SI, 410SI
106890	RPM-313	313SI
106923	RPM-362/368	368SI, 460SI
106889	RPM-363	363SI
106891	RPM-392/398	398SI, 490SI
106888	RPM-393	393SI
112719	RPM-410F	410SI, 419SI
106905	RPM-460F	469SI
106904	RPM-490F	499SI
FASTPRIME® RPM KITS		
106857	RPM-822	822SI, 828SI
106985	RPM-823	823SI
106858	RPM-832	832SI, 838SI
106986	RPM-833	833SI
106859	RPM-842	842SI, 848SI
106987	RPM-843	843SI
107008	RPM-919	919SI
106875	RPM-929	929SI
106876	RPM-939	939SI, 949SI
106877	RPM-949	949SI
AUTOPRIME™ DE-GAS RPM KITS		
106866	RPM-A20A	A20HI, A28AI
106867	RPM-A30A	A30HI, A38AI
106868	RPM-A40A	A40HI, A48AI
106899	RPM-D68	D60HI, D68AI
106898	RPM-D98	D90HI, D98AI, D18AI
HIGH VISCOSITY RPM KITS		
107018	RPM-624	624VI
107019	RPM-634	634VI
EXCEL XR SERIES RPM KITS		
107053	RPM54771	A44AC
107061	RPM54773	A74TC
107054	RPM54780	A46VC, A76VC

LMI Chemical Solution Tanks



Use these Chemical Solution Tanks to store most corrosive and noncorrosive solutions.

The slightly translucent 10 Gallon Tank allows you to check the solution level at a glance. Large fill hole at top allows easy replenishing of solution. Tank features a recess for mounting a LMI pump.

Use the 35 Gallon Tank for flooded suction or suction lift application. For a flooded suction application (which is ideal for off-gassing chemicals and applications where very low output is required), place the LMI pump recess area near the bottom of the tank. For a suction lift application, place the LMI pump on the molded recess at the top of the tank. Tank includes a shut-off valve, discharge tubing retainer and large fill hole.

The 50 Gallon Tank has a high rigidity black polyethylene cover with molded recess for mounting of a LMI pump and has self-supporting, tapered sides.

FEATURES & BENEFITS

- UV resistant, yellow polyethylene tank
- Suitable for most corrosive and noncorrosive solutions
- 5-gallon (20 liter) graduations

CERTIFICATIONS

- Certified to NSF/ANSI Standard 61 and 372

C&M PART #	MFG PART #	CAPACITY (GAL)	DIMENSIONS (Dia x H)	CONFIGURATION
107042	27421	10	14" x 18"	Top Mount
107043	27400	35	20" x 31"	Flooded Suction or Top Mount
107044	26350	50	23" x 42-3/4"	Top Mount

PULSAtron® Series MP Pumps



The PULSAtron Series MP Pumps deliver precise and accurate metering control. The three-line, backlit LCD display along with a six-key keypad provide user-friendly, simple prompts for easy configuration and easy reading. Set timed sequences for selected intervals (1 to 999 hours), selected run rates (1 to 999 hours) and selected stroke rate for repetitive metering.

Operate pump in manual mode with center dial for adjusting stroke length or pace the pump remotely as it accepts either a pulse input or 4 to 20 mA input signals. The stop function input signal shuts off the pump when the chemical day tank is low or if there is no flow in the process stream.

Pumps with feed verification feature sensor monitors flow, and if no flow is detected, display will indicate "Flow Failure". Pump will stop and an alarm signal will be activated.

FEATURES & BENEFITS

- Use relay output to signal auto dialer or alarm
- Alarm signals for signal loss, full count, circuit failure, pulse overflow and pulse rate high
- Liquid low-level indicator
- Multiply or divide pulse signals by 1 to 999 to allow pumps to handle peak requirements
- Calibrated flow rate display with total volume pumped last day, month and since last reset

INCLUDES

Injection valve, foot valve/strainer, suction valve, discharge valve, 5-function valve, 4-ft L suction tubing, 4-ft L bleed valve return tubing, 8-ft L polyethylene discharge tubing and (3) signal cords (external pacing/4-20 mA, stop function, signal relay)

SPECIFICATIONS

ACCURACY	±2%
SUCTION LIFT (ft)	4
POWER	115 VAC
DISPLAY	LCD, 3-Line Backlit
INPUT	Pulse, 4 to 20 mA, Start/Stop Signal
OUTPUT	Contact Closure (Alarm)
MAX VISCOSITY (cP)	1000
TURNDOWN RATIO	1000:1

C&M PART #	MFG PART #	FLOW MAX (GPD)	PRESSURE MAX (PSI)	CONNECTION (TUBE OD)	KOPKIT
SERIES MP PUMPS: PVC Head/Fittings, PTFE diaphragm and seats/O-rings, ceramic check balls					
10543517Q3DG	LMA3TA-VTC1-500	12	100	3/8"	K3-VTC1
10543517Q3ED	LMB3TA-VTC1-500	12	150	3/8"	K3-VTC1
10543517V7ED	LMD4TA-VTC1-500	21	150	3/8"	K4-VTC1
10543517X1DG	LMB4TA-VTC1-500	24	100	3/8"	K4-VTC1
10543517APED	LMG4TA-VTC1-500	42	150	3/8"	K4-VTC1
10543517ATDG	LME4TA-VTC1-500	44	100	3/8"	K4-VTC1
10543519BRED	LMK5TA-VTC3-500	60	150	1/2"	K5-VTC3
10543519CGED	LMH5TA-VTC3-500	75	150	1/2"	K5-VTC3
10543519DSDG	LMH6TA-VTC3-500	120	100	1/2"	K6-VTC3
10543519MRBC	LMK7TA-WTC3-500	190	50	1/2"	K7-WTC3
10543519MTAC	LMH7TA-WTC3-500	240	35	1/2"	K7-WTC3
10543524MYV2	LMH8TA-WTCB-XXX	504	20	3/4"	K8-WTCB
SERIES MP PUMPS FOR USE WITH PERACETIC ACID: PVDF Head/Fittings, PTFE diaphragm and seats/O-rings, ceramic check balls, tested/certified by WQA to NSF/ANSI 61 and 372 standards					
10544917F9EP	LMB2TA-KTC1-500	5	250	3/8"	K2-KTC1
10544917V2EP	LMF4TA-KTC1-500	20	250	3/8"	K4-KTC1
10544917ALEP	LMH4TA-KTC1-500	40	250	3/8"	K4-KTC1
SERIES MP PUMPS WITH FEED VERIFICATION SENSOR (VITON® SEALS): PVC Head/Fittings, PTFE diaphragm and seats/O-rings, ceramic check balls					
10545217R6DG	LMK3TA-VTC1-XXX	14	100	3/8"	K3-VTC1
10545217X1DG	LMB4TA-VTC1-XXX	24	100	3/8"	K4-VTC1
10545217ATDG	LME4TA-VTC1-XXX	44	100	3/8"	K4-VTC1

**PULSATRON® KOPKIT®
REPAIR/MAINTENANCE KITS**

The PULSAtron KOPKit (Keep-On-Pumping) Kits help you reduce pump downtime, are readily available and include everything needed to return pumps to good-as-new condition. Use the kits for preventative maintenance to ensure continuous high performance from your PULSAtron metering pumps. Save money by buying the kits instead of ordering individual parts. See **page 51** for KOPKits.



PULSAtron® Series E Plus Manual and Automatic Control Chemical Feed Pumps



PULSAFEEDER

The PULSAtron Series E Plus Pumps are easy to set up and have outstanding priming characteristics. All Series E Plus pumps feature an on/off switch and manual speed and stroke controls as standard.

Choose pumps from two head styles and either manual, pulse input or 4 to 20 mA input. All pumps feature an external stop function signal input. When external signal is input to the pump control panel, pump operation is stopped and red lamp is lit. The stop function overrides both manual settings and external input. Select specific pumps configured for use with general chemicals, peracetic acid, sodium hypochlorite or fluoride applications. Pumps with a standard head feature a manual bleed valve to prevent loss of prime due to off-gassing. Pumps for use with sodium hypochlorite and other outgassing chemicals feature an innovative degassing head, which allows the pump to be completely self-priming without the use of a bleed valve.

FEATURES & BENEFITS

- Auto-off manual switch
- External stop function signal input
- Guided ball check valve system to reduce back flow and enhance outstanding priming characteristics
- Highly reliable timing circuit
- Circuit protection against voltage and current upsets
- Water resistant—use for indoor and outdoor applications
- Solenoid protection by thermal overload with auto reset
- Indicator lights

INCLUDES

Injection check valve assembly, foot valve/strainer, suction valve, discharge valve, 4-ft L PVC suction tubing, 4-ft L bleed valve return tubing and 8-ft L PE discharge tubing; Standard heads include bleed valve; Pumps configured for use with sodium hypochlorite and other outgassing chemicals include degassing head (no bleed valve)

SPECIFICATIONS

ACCURACY	±2%
SUCTION LIFT (ft)	4
POWER	115 VAC
MAX VISCOSITY (cP)	1000
TURNDOWN RATIO	100:1
PUMP INPUTS	
All E Plus pumps	External Stop Function
Manual control pumps	None
Pulse control pumps	Pulse
4 to 20 mA control pumps	4 to 20 mA

C&M PART #	MFG PART #	FLOW MAX (GPD)	PRESSURE MAX (PSI)	CONNECTION (TUBE OD)	KOPKIT
SERIES E PLUS PUMPS: PVC head/fittings, PTFE diaphragm and seats/O-rings, ceramic check balls					
Manual Control					
1053734SI2ED	LPA2SA-VTCJ-XXX	6	150	3/8"	K2-VTCJ
1053734SQ3DG	LPA3SA-VTC1-XXX	12	100	3/8"	K3-VTC1
10537317Q3ED	LPB3SA-VTC1-XXX	12	150	3/8"	K3-VTC1
10537317X1DG	LPB4SA-VTC1-XXX	24	100	3/8"	K4-VTC1
1053734SV7ED	LPD4SA-VTC1-XXX	21	150	3/8"	K4-VTC1
10537317ATDG	LPE4SA-VTC1-XXX	44	100	3/8"	K4-VTC1
1053734SAPED	LPG4SA-VTC1-XXX	42	150	3/8"	K4-VTC1
1053734SCGE	LPH5SA-VTC3-XXX	75	150	1/2"	K5-VTC3
1053730EODSDG	LPH6SA-VTC3-XXX	120	100	1/2"	K6-VTC3
1053734RMTAC	LPH7SA-WTC3-XXX	240	35	1/2"	K7-WTC3
1053734RMTCM	LPJ7SA-WTC3-XXX	240	80	1/2"	K7-WTC3
1053734RFGZ1	LPH8SA-WTCB-XXX	600	30	3/4"	K8-WTCB
10537317F9EP	LPB2SA-KTCJ-XXX	5	250	3/8"	K2-KTCJ
10537317Q3EP	LPD3SA-KTC1-XXX	12	250	3/8"	K3-KTC1
10537317V2EP	LPF4SA-KTC1-XXX	20	250	3/8"	K4-KTC1
10537317ANEP	LPH4SA-KTC1-XXX	41	250	3/8"	K4-KTC1
Pulse Input Control					
1053754SI2ED	LPA2EA-VTCJ-XXX	6	150	3/8"	K2-VTCJ
1053754SQ3ED	LPB3EA-VTC1-XXX	12	150	3/8"	K3-VTC1
1053754SW2ED	LPD4EA-VTC1-XXX	22	150	3/8"	K4-VTC1
1053754SX1DG	LPB4EA-VTC1-XXX	24	100	3/8"	K4-VTC1
1053754SATDG	LPE4EA-VTC1-XXX	44	100	3/8"	K4-VTC1
1053754RCHED	LPH5EA-VTC3-XXX	76	150	1/2"	K5-VTC3
1053754RDSGD	LPH6EA-VTC3-XXX	120	100	1/2"	K6-VTC3
1053754RMTAC	LPH7EA-WTC3-XXX	240	35	1/2"	K7-WTC3
1053754RMTCM	LPJ7EA-WTC3-XXX	240	80	1/2"	K7-WTC3
1053753VFGZ1	LPH8EA-WTCB-XXX	600	30	3/4"	K8-WTCB
4 to 20 mA Input Control					
1053824SI2ED	LPA2MA-VTCJ-XXX	6	150	3/8"	K2-VTCJ
10538217Q3DG	LPA3MA-VTC1-XXX	12	100	3/8"	K3-VTC1
10538217Q3ED	LPB3MA-VTC1-XXX	12	150	3/8"	K3-VTC1
10538217W2ED	LPD4MA-VTC1-XXX	22	150	3/8"	K4-VTC1
10538217X1DG	LPB4MA-VTC1-XXX	24	100	3/8"	K4-VTC1
10538217APED	LPG4MA-VTC1-XXX	42	150	3/8"	K4-VTC1
10538217ATDG	LPE4MA-VTC1-XXX	44	100	3/8"	K4-VTC1
10538219CHED	LPH5MA-VTC3-XXX	76	150	1/2"	K5-VTC3
10538219DSDG	LPH6MA-VTC3-XXX	120	100	1/2"	K6-VTC3
10538219MTAC	LPH7MA-WTC3-XXX	240	35	1/2"	K7-WTC3
10538219MTCM	LPJ7MA-WTC3-XXX	240	80	1/2"	K7-WTC3
10538224FGZ1	LPH8MA-WTCB-XXX	600	30	3/4"	K8-WTCB

Continued on Next Page



PULSAtron® Series E Plus Manual and Automatic Control Chemical Feed Pumps *(continued)*

C&M PART #	MFG PART #	FLOW MAX (GPD)	PRESSURE MAX (PSI)	CONNECTION (TUBE OD)	KOPKIT
SERIES E PLUS PUMPS FOR USE WITH PERACETIC ACID: PVDF head/fittings, PTFE diaphragm and seats/O-rings, ceramic check balls: tested/certified by WQA to NSF/ANSI 61 and 372 standards					
Manual Control					
1053744SI2ED	LPA2SA-KTCJ-XXX	6	150	3/8"	K2-KTCJ
1053744SQ3DG	LPA3SA-KTCJ-XXX	12	100	3/8"	K3-KTCJ
1053744SQ3ED	LPB3SA-KTC1-XXX	12	150	3/8"	K3-KTC1
1053744SW2ED	LPD4SA-KTC1-XXX	22	150	3/8"	K4-KTC1
1053744SX1DG	LPB4SA-KTC1-XXX	24	100	3/8"	K4-KTC1
1053744SAPED	LPG4SA-KTC1-XXX	42	150	3/8"	K4-KTC1
1053744SATDG	LPE4SA-KTC1-XXX	44	100	3/8"	K4-KTC1
1053744RSDSG	LPH6SA-KTC3-XXX	120	100	1/2"	K6-KTC3
Pulse Input Control					
1053764SF9EP	LPB2EA-KTCJ-XXX	5	250	3/8"	K2-KTCJ
1053764SI2ED	LPA2EA-KTCJ-XXX	6	150	3/8"	K2-KTCJ
1053764SQ3DG	LPA3EA-KTCJ-XXX	12	100	3/8"	K3-KTCJ
1053764SQ3ED	LPB3EA-KTC1-XXX	12	100	3/8"	K3-KTC1
1053764SQ3EP	LPD3EA-KTC1-XXX	12	150	3/8"	K3-KTC1
1053764SV2EP	LPF4EA-KTC1-XXX	20	250	3/8"	K4-KTC1
1053764SW2ED	LPD4EA-KTC1-XXX	22	150	3/8"	K4-KTC1
1053764SX1DG	LPB4EA-KTC1-XXX	24	100	3/8"	K4-KTC1
1053764SANEP	LPH4EA-KTC1-XXX	41	250	3/8"	K4-KTC1
1053764SAPED	LPG4EA-KTC1-XXX	42	150	3/8"	K4-KTC1
1053764SATDG	LPE4EA-KTC1-XXX	44	100	3/8"	K4-KTC1
1053764SDSDG	LPH6EA-KTC3-XXX	120	100	3/8"	K6-KTC3
1053764SMTCM	LPJ7EA-KTC3-XXX	240	80	3/8"	K7-KTC3
4 to 20 mA Input Control					
1053774SF9EP	LPB2MA-KTCJ-XXX	5	250	3/8"	K2-KTCJ
1053774SI2ED	LPA2MA-KTCJ-XXX	6	150	3/8"	K2-KTCJ
1053774SQ3ED	LPB3MA-KTC1-XXX	12	150	3/8"	K3-KTC1
1053774SQ3EP	LPD3MA-KTC1-XXX	12	250	3/8"	K3-KTC1
1053774SV2EP	LPF4MA-KTC1-XXX	20	250	3/8"	K4-KTC1
1053774SW2ED	LPD4MA-KTC1-XXX	22	150	3/8"	K4-KTC1
1053774SX1DG	LPB4MA-KTC1-XXX	24	100	3/8"	K4-KTC1
1053774SANEP	LPH4MA-KTC1-XXX	41	250	3/8"	K4-KTC1
1053774SAPED	LPG4MA-KTC1-XXX	42	150	3/8"	K4-KTC1
1053774SATDG	LPE4MA-KTC1-XXX	44	100	3/8"	K4-KTC1
1053774SDSDG	LPH6MA-KTC3-XXX	120	100	3/8"	K6-KTC3
1053774SMTCM	LPJ7MA-KTC3-XXX	240	80	3/8"	K7-KTC3

C&M PART #	MFG PART #	FLOW MAX (GPD)	PRESSURE MAX (PSI)	CONNECTION (TUBE OD)	KOPKIT
SERIES E PLUS PUMPS WITH DEGASSING HEAD FOR USE WITH SODIUM HYPOCHLORITE AND OTHER OUTGASSING CHEMICALS: PVC Head/Fittings, PTFE diaphragm and Viton® seats/O-rings, ceramic check balls; tested/certified by WQA to NSF/ANSI 61 and 372 standards					
Manual Control					
10540417I2ED	LPA2SA-VVC9-XXX	6	150	3/8"	K2-VVC9
10540417Q3DG	LPA3SA-VVC9-XXX	12	100	3/8"	K3-VVC9
10540417Q3ED	LPB3SA-VVC9-XXX	12	150	3/8"	K3-VVC9
10540417W2ED	LPD4SA-VVC9-XXX	22	150	3/8"	K4-VVC9
10540417X1DG	LPB4SA-VVC9-XXX	24	100	3/8"	K4-VVC9
10540417APED	LPG4SA-VVC9-XXX	42	150	3/8"	K4-VVC9
10540417ATDG	LPE4SA-VVC9-XXX	44	100	3/8"	K4-VVC9
Pulse Input Control					
1053784SI2ED	LPA2EA-VVC9-XXX	6	150	3/8"	K2-VVC9
1053784SQ3DG	LPA3EA-VVC9-XXX	12	100	3/8"	K3-VVC9
1053784SQ3ED	LPB3EA-VVC9-XXX	12	150	3/8"	K3-VVC9
1053784SW2ED	LPD4EA-VVC9-XXX	22	150	3/8"	K4-VVC9
1053784SX1DG	LPB4EA-VVC9-XXX	24	100	3/8"	K4-VVC9
1053784SAPED	LPG4EA-VVC9-XXX	42	150	3/8"	K4-VVC9
1053784SATDG	LPE4EA-VVC9-XXX	44	100	3/8"	K4-VVC9
4 to 20 mA Input Control					
10541117I2ED	LPA2MA-VVC9-XXX	6	150	3/8"	K2-VVC9
10541117Q3DG	LPA3MA-VVC9-XXX	12	100	3/8"	K3-VVC9
10541117Q3ED	LPB3MA-VVC9-XXX	12	150	3/8"	K3-VVC9
10541117W2ED	LPD4MA-VVC9-XXX	22	150	3/8"	K4-VVC9
1054114SATDG	LPE4MA-VVC9-XXX	44	100	3/8"	K4-VVC9
1054117X1DG	LPB4MA-VVC9-XXX	24	100	3/8"	K4-VVC9
1054117APED	LPG4MA-VVC9-XXX	42	150	3/8"	K4-VVC9
SERIES E PLUS SERIES PUMPS FOR USE WITH FLUORIDE: PVC Head/Fittings, PTFE diaphragm, PTFE seats/O-rings and PTFE check balls					
Manual Control					
10541817Q3DG	LPA3SA-VTT1-XXX	12	100	3/8"	K3-VTT1
10541817X1DG	LPB4SA-VTT1-XXX	24	100	3/8"	K4-VTT1
10541817ATDG	LPE4SA-VTT1-XXX	44	100	3/8"	K4-VTT1
10541819SDSG	LPH6SA-VTT3-XXX	120	100	1/2"	K6-VTT3
10541819MTAC	LPH7SA-WTT3-XXX	240	35	1/2"	K7-WTT3
1054184RMTCM	LPJ7SA-WTT3-XXX	240	80	1/2"	K7-WTC3
Pulse Input Control					
4016374SX1DG	LPB4EA-VTT1-XXX	24	100	3/8"	K4-VTT1
4016374SATDG	LPE4EA-VTT1-XXX	44	100	3/8"	K4-VTT1
4016374RSDSG	LPH6EA-VTT3-XXX	120	100	1/2"	K6-VTT3
4016374RMTAC	LPH7EA-WTT3-XXX	240	35	1/2"	K7-WTT3
4016374RMTCM	LPJ7EA-WTT3-XXX	240	80	1/2"	K7-WTT3
4 to 20 mA Input Control					
10542417Q3DG	LPA3MA-VTT1-XXX	12	100	3/8"	K3-VTT1
10542417X1DG	LPB4MA-VTT1-XXX	24	100	3/8"	K4-VTT1
10542417ATDG	LPE4MA-VTT1-XXX	44	100	3/8"	K4-VTT1
10542419SDSG	LPH6MA-VTT3-XXX	120	100	1/2"	K6-VTT3
10542419MTAC	LPH7MA-WTT3-XXX	240	35	1/2"	K7-WTT3

Continued on Next Page



PULSAtron® Series E Plus Manual and Automatic Control Chemical Feed Pumps *(continued)*

C&M PART #	MFG PART #	FLOW MAX (GPD)	PRESSURE MAX (PSI)	CONNECTION (TUBE OD)	KOPKIT
SERIES E PLUS SERIES PUMPS FOR USE WITH FLUORIDE: PVDF Head/Fittings, PTFE diaphragm, PTFE seats/O-rings and PTFE check balls; tested/certified by WQA to NSF/ANSI 61 and 372 standards					
Manual Control					
1053794SQ3DG	LPA3SA-KTT1-XXX	12	100	3/8"	K3-KTT1
1053794SX1DG	LPB4SA-KTT1-XXX	24	100	3/8"	K4-KTT1
1053794SATDG	LPE4SA-KTT1-XXX	44	100	3/8"	K4-KTT1
1053794RDS DG	LPH6SA-KTT3-XXX	120	100	1/2"	K6-KTT3
1053794RMTAC	LPH7SA-KTT3-XXX	240	35	1/2"	K7-KTT3
1053794RMTCM	LPJ7SA-KTT3-XXX	240	80	1/2"	K7-KTT3
Pulse Input Control					
1053804SQ3DG	LPA3EA-KTT1-XXX	12	100	3/8"	K3-KTT1
1053804SX1DG	LPB4EA-KTT1-XXX	24	100	3/8"	K4-KTT1
1053804SATDG	LPE4EA-KTT1-XXX	44	100	3/8"	K4-KTT1
1053804RDS DG	LPH6EA-KTT3-XXX	120	100	1/2"	K6-KTT3
1053804RMTAC	LPH7EA-KTT3-XXX	240	35	1/2"	K7-KTT3
1053804RMTCM	LPJ7EA-KTT3-XXX	240	80	1/2"	K7-KTT3
4 to 20 mA Input Control					
4016384SQ3DG	LPA3MA-KTT1-XXX	12	100	3/8"	K3-KTT1
4016384SX1DG	LPB4MA-KTT1-XXX	24	100	3/8"	K4-KTT1
4016384SATDG	LPE4MA-KTT1-XXX	44	100	3/8"	K4-KTT1
4016384RDS DG	LPH6MA-KTT3-XXX	120	100	1/2"	K6-KTT3
4016384RMTAC	LPH7MA-KTT3-XXX	240	35	1/2"	K7-KTT3

REPLACEMENT PARTS & ACCESSORIES

KOPKit® Repair/Maintenance Kits include all necessary wet end replacement parts, including pump head, diaphragm, check valves and seal.

C&M PART #	MFG PART #	C&M PART #	MFG PART #
401639	K2-VTCJ	105430	K3-VTT1
105349	K3-VTC1	105431	K4-VTT1
105350	K4-VTC1	401643	K6-VTT3
105393	K5-VTC3	401644	K7-WTT3
105394	K6-VTC3	401645	K3-KTT1
105395	K7-WTC3	401646	K4-KTT1
105457	K8-WTCB	401647	K6-KTT3
105397	K2-KTCJ	401648	K7-KTT3
105398	K3-KTC1		
401640	K3-KTCJ		
105399	K4-KTC1		
401641	K6-KTC3		
401642	K7-KTC3		
105370	K2-VVC9		
105371	K3-VVC9		
105372	K4-VVC9		



PULSAFEEDER

CHEMICAL DOSAGE PUMP SKID SYSTEMS

See our pre-packaged chemical dosage pump skid systems on **page 56**, which offer you a highly flexible, pre-plumbed system allowing pumps to be added on-site or pre-installed and tested prior to delivery. This approach speeds up the install process without compromising the reliability of the system or its ability to operate in a wide range of water treatment applications. Give us a call at **888-885-2673** for specific configurations, select a pump(s) or use your own, flow rate required and options such as vented ball valve with use with hypochlorite, pulsation dampener, pressure relief valve, pipe material and more.



PULSAtron® Series HV High-Viscosity Pumps

Pulsafeeder's PULSAtron® Series HV Pumps are designed to pump high-viscosity chemicals such as flocculants up to 20,000 cPS. Choose from manual or 4 to 20 mA remote input signal control pump models. Manual control pumps feature knobs for both speed rate (strokes/minute) and stroke length to vary pump output.

FEATURES & BENEFITS

- Auto-off manual switch
- Guided ball check valve system, reduces back flow and enhances outstanding priming characteristics
- Highly reliable timing circuit
- Circuit protection against voltage and current upsets
- Water resistant—use for indoor and outdoor applications
- Solenoid protection by thermal overload with auto reset
- Indicator lights, panel mounted

INCLUDES

Injection check valve assembly, suction valve, discharge valve, 4-ft L PVC suction tubing, 4-ft L bleed valve return tubing and 8-ft L PE discharge tubing; Standard heads include a bleed valve

Note: Due to the high viscosity, foot valves/strainers are NOT recommended for use with these pumps and are not included. Best practice for this application would be flooded-suction set up for high-viscosity pumps.

SPECIFICATIONS

ACCURACY	±2%
POWER	115 VAC
MAX VISCOSITY (cP)	20,000
TURNDOWN RATIO	100:1



C&M PART #	MFG PART #	FLOW MAX (GPD)	PRESSURE MAX (PSI)	CONNECTION (TUBE OD)	KOPKIT
SERIES HV MANUAL CONTROL PUMPS: PVC head/fittings, PTFE diaphragm and seats/O-rings, 316 SS check balls					
10546119Q3ED	LVB3SA-VTT5-XXX	12	150	1/2"	K3-VTT5
10546119X1ED	LVF4SA-VTT5-XXX	24	150	1/2"	K4-VTT5
10546124AZNI	LVG4SA-VTSK-XXX	48	110	3/4"	K4-VTSK
10546124DCNI	LVG5SA-VTSK-XXX	96	110	3/4"	K5-VTSK
10546124MTCM	LVH7SA-WTSK-XXX	240	80	3/4"	K7-WTSK
SERIES HV PUMPS WITH 4 TO 20 MA INPUT CONTROL: PVC head/fittings, PTFE diaphragm and seats/O-rings, 316 SS check balls					
10546619Q3ED	LVB3MA-VTT5-XXX	12	150	1/2"	K3-VTT5
10546619X1ED	LVF4MA-VTT5-XXX	24	150	1/2"	K4-VTT5
10546624AZDG	LVG4MA-VTSK-XXX	48	100	3/4"	K4-VTSK
10546624DCDG	LVG5MA-VTSK-XXX	96	100	3/4"	K5-VTSK
10546624MTCM	LVH7MA-WTSK-XXX	240	80	3/4"	K7-WTSK

REPLACEMENT PARTS & ACCESSORIES

C&M PART #	MFG PART #	DESCRIPTION
1113591819X2	0375-0500-062-23-03-00025	HDPE NSF-61 Tubing, Translucent, 3/8" ID x 1/2" OD, 25-ft L Roll

PULSAtron® KOPKit® Repair/Maintenance Kits

The PULSAtron KOPkit (Keep-On-Pumping) Kits help you reduce pump downtime, are readily available and include everything needed to return pumps to good-as-new condition. Use the kits for preventative maintenance to ensure continuous high performance from your PULSAtron metering pumps. Save money by buying the kits instead of ordering individual parts.



INCLUDES

KOPkit kits for PULSAtron Pumps include all necessary wet end replacement parts:

- Diaphragm
- Pump Head
- Check valve assemblies
- Degassing valve assembly (degas models)
- Deflection plate
- Shims
- Secondary seal
- Installation instructions

NOTE: Use Ordering Table to select the correct KOPKit kit. Wet end number must be known. Wet end starts with a K, followed by the 4th digit in the respective pump's model number, then add the dash and all digits after the pump model number. Example: LPB3SA-VTC1, KOPkit = K3-VTC1

C&M PART #	MFG PART #	C&M PART #	MFG PART #
105348	K2-VTC1	105370	K2-VVC9
401639	K2-VTCJ	105371	K3-VVC9
105349	K3-VTC1	105372	K4-VVC9
105350	K4-VTC1	105430	K3-VTT1
105367	K4-VTC3	105431	K4-VTT1
105393	K5-VTC3	401643	K6-VTT3
105394	K6-VTC3	105459	K6-VTCH
105395	K7-WTC3	105460	K7-KTCH
105457	K8-WTCB	401644	K7-WTT3
105368	K2WTC1	401645	K3-KTT1
105369	K3WTC1	401646	K4-KTT1
105433	K7WTT3	401647	K6-KTT3
105397	K2-KTCJ	401648	K7-KTT3
105458	K2-KTC1	105471	K3-VTT5
105398	K3-KTC1	105472	K4-VTT5
401640	K3-KTCJ	105473	K4-VTSK
105399	K4-KTC1	105474	K5-VTSK
401641	K6-KTC3	105475	K7-WTSK
401642	K7-KTC3		

PULSAtron® Series A Plus Manual Control Chemical Feed Pumps



PULSAFEEDER

The PULSAtron Series A Plus Chemical Feed Pumps are engineered to provide accuracy in chemical dosing. These manual control pumps feature an on/off switch and adjustable stroke length and stroke rate settings, which allow you to precisely control the amount of chemicals added to your water treatment process, ensuring consistent and effective results.

Choose from pumps for either general chemical or sodium hypochlorite applications. General chemical pumps feature a standard head with manual leak-free bleed valve for safe and easy priming. Pumps for use with sodium hypochlorite and other outgassing chemicals feature an innovative degassing head, which allows the pump to be self-priming without the use of a bleed valve.

FEATURES & BENEFITS

- Adjustable stroke length and stroke rate provide accurate chemical dosing
- Guided ball check valve system reduces back flow and enhance outstanding priming characteristics
- Highly reliable timing circuit
- Internally dampened to reduce noise
- Water resistant—use for indoor and outdoor applications

INCLUDES

Injection check valve assembly, foot valve/strainer, suction valve, discharge valve, 4-ft L PVC suction tubing, 4-ft L bleed valve return tubing and 8-ft L PE discharge tubing; Standard heads also include a bleed valve

SPECIFICATIONS

ACCURACY	±3%
SUCTION LIFT (ft)	4
POWER	115 VAC
MAX VISCOSITY (cP)	1000
TURNDOWN RATIO	100:1

C&M PART #	MFG PART #	FLOW MAX (GPD)	PRESSURE MAX (PSI)	CONNECTION (TUBE OD)	KOPKIT
------------	------------	----------------	--------------------	----------------------	--------

SERIES A PLUS MANUAL CONTROL STANDARD PUMPS:

PVC head/fittings, PTFE diaphragm and seats/O-rings, ceramic check balls

10535517I2ED	LB02SA-VTC1-XXX	6	150	3/8"	K2-VTC1
10535517Q3ED	LB03SA-VTC1-XXX	12	150	3/8"	K3-VTC1
10535517X1DG	LB04SA-VTC1-XXX	24	100	3/8"	K4-VTC1
10535517A2BC	LB64SA-VTC1-XXX	30	100	3/8"	K4-VTC1
10535519Z1BC	LBC4SA-VTC3-XXX	48	50	1/2"	K4-VTC3

SERIES A PLUS MANUAL CONTROL STANDARD PUMPS:

PVC head/fittings, PTFE diaphragm and seats/O-rings, ceramic check balls; tested/certified by WQA to NSF/ANSI 61 and 372 standards

10536017I2EP	LBC2SA-WTC1-XXX	6	250	3/8"	K2-VTC1
10536017N8EP	LBC3SA-WTC1-XXX	10	250	3/8"	K3-WTC1
10536017Q3EP	LBS2XA-WTCJ-U03	12	250	3/8"	K2-WTCJ

SERIES A PLUS MANUAL CONTROL PUMPS WITH DEGASSING HEAD FOR USE WITH SODIUM HYPOCHLORITE AND OTHER OUTGASSING CHEMICALS: PVC head/fittings, PTFE diaphragm and Viton® seats/O-rings, ceramic check balls; tested/certified by WQA to NSF/ANSI 61 and 372 standards

10536317I2ED	LB02SA-VVC9-XXX	6	150	3/8"	K2-VVC9
10536317Q3ED	LB03SA-VVC9-XXX	12	150	3/8"	K3-VVC9
10536317X1DG	LB04SA-VVC9-XXX	24	100	3/8"	K4-VVC9
10536317Z1DG	LB64SA-VVC9-XXX	30	100	3/8"	K4-VVC9

REPLACEMENT PARTS & ACCESSORIES

C&M PART #	MFG PART #	DESCRIPTION
1113591817X2	0250-0375-062-23-03-00025	HDPE NSF-61 Tubing, Translucent, 1/4" ID x 3/8" OD, 25 ft L Roll
1113591717X2	0250-0375-062-23-13-00025	HDPE NSF-61 Tubing, Black, 1/4" ID x 3/8" ID, 25 ft L Roll
1113591819X2	0375-0500-062-23-03-00025	HDPE NSF-61 Tubing, Translucent, 3/8" ID x 1/2" OD, 25 ft L Roll

Pulsafeeder Heavy-Duty Chemical Solution Tanks

These tapered HDPE Chemical Solution Tanks feature rigid covers that accommodate top mounting of CHEM-TECH 100, 200, most PULSAtron pump models and 1/20-hp flange mount mixers. The covers feature a 4.5" refill cap, 1.4" cap pump accessories and two 3.5" indent for mounting accessories. Tanks are translucent and come with 5-gallon graduations.

Note: Not suitable for use with 1/3 HP Flange Mount Mixers.

C&M PART #	MFG PART #	CAPACITY (GAL)	DIMENSIONS (Dia X H)	CONFIGURATION
105478	40365	35	23" x 28"	Top Mount
105479	J40366	50	23" x 42.5"	Top Mount



PULSAFEEDER



PULSAtron® Series C & C Plus Manual Control Chemical Feed Pumps

The PULSAtron Series C and C Plus Manual Control Chemical Feed Pumps are an economical solution for simple chemical dosing applications while offering excellent durability. Series C pumps feature a fixed-speed rate (strokes/minute) and a single-dial knob which controls the stroke length to vary the pump output. Series C Plus pumps feature dual-dial knobs, one for varying the speed rate and the other for controlling the stroke length.



FEATURES & BENEFITS

- Safe and easy priming with durable leak-free bleed valve assembly
- Guided ball check valve system reduces back flow and enhance outstanding priming characteristics
- Highly reliable timing circuit
- Internally dampened to reduce noise
- Water resistant—use for indoor and outdoor applications

INCLUDES

Injection check valve assembly, foot valve/strainer, suction valve, discharge valve, 4-ft L PVC suction tubing, 4-ft L bleed valve return tubing and 8-ft L PE discharge tubing; Standard heads also include a bleed valve

SPECIFICATIONS

ACCURACY	±3%
SUCTION LIFT (ft)	4
POWER	115 VAC
MAX VISCOSITY (cP)	1000
TURNDOWN RATIO	10:1 C Pumps, 100:1 C Plus Pumps

C&M PART #	MFG PART #	FLOW MAX (GPD)	PRESSURE MAX (PSI)	CONNECTION (TUBE OD)	KOPKIT
SERIES C MANUAL CONTROL PUMPS: PVC head/fittings, PTFE diaphragm and seats/O-rings, ceramic check balls					
10534417I2CM	LC02SA-VTC1-XXX	6	80	3/8" or 1/2"	K2-VTC1
10534417Q3CM	LC03SA-VTC1-XXX	12	80	3/8"	K3-VTC1
10534417X1CM	LC04SA-VTC1-XXX	24	80	3/8"	K4-VTC1
10534417Z1CM	LC54SA-VTC1-XXX	30	80	3/8"	K5-VTC1
SERIES C PLUS MANUAL CONTROL PUMPS: PVC head/fittings, PTFE diaphragm and seats/O-rings, ceramic check balls					
10535117I2CM	LD02SA-VTC1-XXX	6	80	3/8"	K2-VTC1
10535117Q3CM	LD03SA-VTC1-XXX	12	80	3/8"	K3-VTC1
10535117X1CM	LD04SA-VTC1-XXX	24	80	3/8"	K4-VTC1
10535117Z1CM	LD54SA-VTC1-XXX	30	80	3/8"	K5-VTC1

REPLACEMENT PARTS & ACCESSORIES

C&M PART #	MFG PART #	DESCRIPTION
1113591817X2	0250-0375-062-23-03-00025	HDPE NSF-61 Tubing, Translucent, 1/4" ID x 3/8" OD, 25-ft L Roll
1113591717X2	0250-0375-062-23-13-00025	HDPE NSF-61 Tubing, Black, 1/4" ID x 3/8" OD, 25-ft L Roll

SUGGESTED PRODUCTS

Peabody Aquarius Tapered Chemical Feed Tanks



Aquarius Tapered Chemical Feed Tanks nest nicely inside one another to save you money on shipping and storage. These polyethylene (PE) chemical feed tanks have a 22-degree mixer mounting surface, 100# rated pump surface with recessed collection reservoir, a 4" inspection port and two 2" NPT(F) fittings. Standard colors are translucent white, Gemini blue, yellow or black; other custom colors are available on request. Standard tanks are NSF/ANSI/CAN 61 certified. XLPE, PPL and PVDF tanks are available on request.

C&M PART #	MFG PART #	CAPACITY (Gal)	MATERIAL	WALL THICKNESS	COLOR	DIMENSIONS
108395Z119AK	01-28643	30	LPE 1.5	3/16"	Blue	27" Dia x 21.25"H
108395Z12XAK	01-28641	30	LPE 1.5	3/16"	Natural	27" Dia x 21.25"H
108395Z1D7AK	01-28642	30	LPE 1.5	3/16"	Yellow	27" Dia x 21.25"H
108395Z117AK	01-28644	30	LPE 1.5	3/16"	Black	27" Dia x 21.25"H
108395Z119AL	01-28647	30	LPE 1.9	5/16"	Blue	27" Dia x 21.25"H
108395Z12XAL	01-28645	30	LPE 1.9	5/16"	Natural	27" Dia x 21.25"H
108395Z1D7AL	01-28646	30	LPE 1.9	5/16"	Yellow	27" Dia x 21.25"H
108395Z117AL	01-28648	30	LPE 1.9	5/16"	Black	27" Dia x 21.25"H
108403BJ19AK	01-28651	55	LPE 1.5	3/16"	Blue	27" Dia x 35.5"H
108403BJ2XAK	01-28649	55	LPE 1.5	3/16"	Natural	27" Dia x 35.5"H
108403BJD7AK	01-28650	55	LPE 1.5	3/16"	Yellow	27" Dia x 35.5"H
108403BJ17AK	01-28652	55	LPE 1.5	3/16"	Black	27" Dia x 35.5"H
108403BJ19AL	01-28655	55	LPE 1.9	5/16"	Blue	27" Dia x 35.5"H
108403BJ2XAL	01-28653	55	LPE 1.9	5/16"	Natural	27" Dia x 35.5"H
108403BJD7AL	01-28654	55	LPE 1.9	5/16"	Yellow	27" Dia x 35.5"H
108403BJ17AL	01-28656	55	LPE 1.9	5/16"	Black	27" Dia x 35.5"H

PULSAtron® KOPKit® Repair/Maintenance Kits

The PULSAtron KOPkit (Keep-On-Pumping) Kits help you reduce pump downtime, are readily available and include everything needed to return pumps to good-as-new condition. Use the kits for preventative maintenance to ensure continuous high performance from your PULSAtron metering pumps. Save money by buying the kits instead of ordering individual parts.

INCLUDES

KOPkit kits for PULSAtron Pumps include all necessary wet end replacement parts:

- Diaphragm
- Pump Head
- Check valve assemblies
- Degassing valve assembly (degas models)
- Deflection plate
- Shims
- Secondary seal
- Installation instructions

NOTE: Use Ordering Table to select the correct KOPKit kit. Wet end number must be known. Wet end starts with a K, followed by the 4th digit in the respective pump's model number, then add the dash and all digits after the pump model number. Example: LPB3SA-VTC1, KOPKit = K3-VTC1



PULSAFEEDER

C&M PART #	MFG PART #	C&M PART #	MFG PART #
105348	K2-VTC1	105370	K2-VVC9
401639	K2-VTCJ	105371	K3-VVC9
105349	K3-VTC1	105372	K4-VVC9
105350	K4-VTC1	105430	K3-VTT1
105367	K4-VTC3	105431	K4-VTT1
105393	K5-VTC3	401643	K6-VTT3
105394	K6-VTC3	105459	K6-VTCH
105395	K7-WTC3	105460	K7-KTCH
105457	K8-WTCB	401644	K7-WTT3
105368	K2WTC1	401645	K3-KTT1
105369	K3WTC1	401646	K4-KTT1
105433	K7WTT3	401647	K6-KTT3
105397	K2-KTCJ	401648	K7-KTT3
105458	K2-KTC1	105471	K3-VTT5
105398	K3-KTC1	105472	K4-VTT5
401640	K3-KTCJ	105473	K4-VTSK
105399	K4-KTC1	105474	K5-VTSK
401641	K6-KTC3	105475	K7-WTSK
401642	K7-KTC3		

PULSAtron® PEP Kits

A PULSAtron PEPkit (Pump Enhancement Parts) Kit allows for convenient regular maintenance as it contains the replacement pump parts which are included in KOPKits, along with common replacement chemical feed line parts. PEP kits can help you cut downtime and allows you to get your pump back on line fast. Save money by buying the kit instead of ordering individual parts.

NOTE: The KOPKit number is stamped on the name plate of the pump and is listed on the Specification Data Sheet.

INCLUDES

Kits Include:

- Bleed valve assembly (NOT with degas models); degassing valve assembly (degas models)
- Replacement tubing: 4-ft suction tubing, 8-ft L discharge tubing
- Injection valve assembly
- Foot valve and strainer
- Deflection plate
- Shims
- Secondary seal
- KOPKit (repair kit): includes all necessary wet end replacement parts including pump head, diaphragm, seal and check valve assemblies
- Installation instructions

C&M PART #	MFG PART #	WET END
105500	P2PTC1	K2-PTC1
105501	P2PTCJ	K2-PTCJ
105502	P3PTC1	K3-PTC1
105503	P3VTC1	K3-VTC1
105504	P3VTCJ	K3-VTCJ
105505	P4KTC1	K4-KTC1
105506	P4PTC1	K4-PTC1
105507	P4VHC1	K4-VHC1
105508	P4VTC1	K4-VTC1
105509	P4VVC9	K4-VVC9
105510	P5PTC3	K5-PTC3
105511	P5VTC3	K5-VTC3
105512	P6PTC3	K6-PTC3
105513	P6VTC3	K6-VTC3
105514	P7PTC3	K7-PTC3
105515	P8WTCB	K8-WTCB



PULSAFEEDER

Chem-Tech XP & XPV Peristaltic Pumps

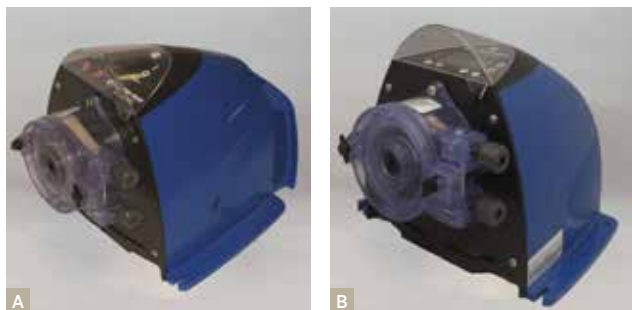

Peristaltic pumps are self-priming and off-gas tolerant, making them ideal for chlorine and other volatile chemical applications. These XP and XPV pumps prevent air-lock and loss of prime to deliver worry-free dosing in a modern design. Both models feature an intuitive interface and controls to provide easy operation.

XP Series Pumps operate at a fixed RPM rate. They feature a control dial to adjust percentage or run time from 10 to 100% and a three-position switch (on, off, prime).

XPV Series Pumps feature a variable-speed motor and LCD display which displays operating parameters. XPV pumps accept remote control pulse input and 4 to 20 mA input signals along with external stop or manual operation in fixed-speed mode. One button press displays flow total and allows you to set flow verification that stops the pump and activates alarm if flow is interrupted. XPV pumps can run in multiple modes; fixed speed, cycle timer, daily timer, pulse input or 4 to 20mA. Panel lights indicate Run, Stop, Fault. XPV models also have a Relay Output to indicate stop input, low and high 4 to 20mA alarm, circuit failure and pump running.

FEATURES & BENEFITS

- Self-Priming
- Can pump Sodium Hypochlorite and other gaseous chemicals

INCLUDES

Spare pump tube, suction strainer with ceramic weight, 15 ft L 1/4" OD PE tubing and injection check valve assembly

SPECIFICATIONS

MODEL	XP	XPV
ACCURACY	±2%	±3%
SUCTION LIFT (ft)	20	10
POWER	115 VAC	115 VAC
INPUT	None	Pulse, 4 to 20 mA
MAX VISCOSITY (cP)	300	300
TURNDOWN RATIO	20:1	100:1
WET END MATERIALS	Neoprene tubing, PVC	

C&M PART #	MFG PART #	MAX FLOW (GPD)	MAX PRESSURE (PSI)	CONNECTION	KOPKIT, C&M PART#	REPLACEMENT PUMP TUBES, C&M PART#
A XP SERIES MANUAL CONTROL, ADJUSTABLE-RATE PUMPS						
10548411C1DU	XP004LAHX	4	125	1/4"	105496	107118
10548411M5NI	XP009LAHX	9	110	1/4"	105497	107119
10548411S2NI	XP015LAHX	15	110	1/4"	105497	107119
10548411W5DG	XP023LAHX	23	100	1/4"	105498	107121
10548411Z1CM	XP030LAHX	30	80	1/4"	105499	107122
B XPV SERIES MANUAL OR EXTERNAL CONTROL VIA 4 TO 20 mA OR PULSE INPUT PUMPS						
10549111L1DU	XP008LVHX	8	125	1/4"	105496	107118
10549111T7NI	XP017LVHX	17	110	1/4"	105497	107119
10549111Z9DG	XP033LVHX	33	100	1/4"	105498	107121
10549111B1JCM	XP055LVHX	55	80	1/4"	105499	107122

REPLACEMENT PARTS & ACCESSORIES

C&M PART #	MFG PART #	DESCRIPTION
105496	NCKA2HPAP1	Chem-Tech KOPKit, (Includes Pump Head Assembly & Tubing)
105497	NCKA3HPAP1	Chem-Tech KOPKit, (Includes Pump Head Assembly & Tubing)
105498	NCKA4HPAP1	Chem-Tech KOPKit, (Includes Pump Head Assembly & Tubing)
105499	NCKA6HPAP1	Chem-Tech KOPKit, (Includes Pump Head Assembly & Tubing)
107118	NC90XX2HPA-XXXXX	Tube Kit (Tube & Fittings)
107119	NC90XX3HPA-XXXXX	Tube Kit (Tube & Fittings)
107121	NC90XX4HPA-XXXXX	Tube Kit (Tube & Fittings)
107122	NC90XX6HPA-XXXXX	Tube Kit (Tube & Fittings)



Chem-Tech KOPKit



Tube Kit

WE'D LIKE YOUR FEEDBACK

on our catalog and website



Send us your thoughts at

support.supply@coreandmain.com

Grundfos SMART DDE Digital S & XL Chemical Feed Pumps



The SMART DDE Digital S and XL Series pumps offer a cost-effective Digital Dosing™ solution with basic functions for simple applications. Unlike pumps that rely on stroke length/frequency adjustment with solenoid drives, the DDE S and XL pumps feature a powerful variable-speed stepper motor with internal stroke speed control for smooth, continuous dosing and impressive turndown ratios.

Easily set dosing capacity from 0.1 to 100% using the intuitive user interface. SMART Digital pumps have very long service and maintenance intervals, significantly lowering pump life-cycle cost and contributing to disruption-free, reliable dosing performance. Choose from B control variant, manual speed control pumps or PR/AR variant pumps which can run in manual mode as well as accept a pulse input or 4 to 20 mA control signal.

FEATURES & BENEFITS

- Accurate, stepper and permanent magnet synchronous motor technology
- Cost effective, provides thousands of hours or reliable operation before service is required
- User-friendly, intuitive wheel and button interfaces
- Flexible, high turndown ratio, mounting plate and adjustable control cube
- Mount pump on horizontal or vertical surfaces

SPECIFICATIONS

MODEL	S SERIES	XL SERIES
ACCURACY	±5%	
SUCTION LIFT (ft)	20	10
POWER	100-240 VAC, 50/60Hz, single-phase	
INPUT	B Variant: None PR: External Stop, Pulse Control, Low Level, Empty Tank	B Variant: None AR: External Stop, Pulse Control, 0/4 to v20 mA, Low Level, Empty Tank
OUTPUT	B Variant: None PR/AR: (2) Output Relays	

CERTIFICATIONS

- UL, CSA, cUL

C&M PART #	MFG PART #	MAX FLOW (GPD)	MAX PRESSURE (PSI)	CONNECTION	TURNDOWN	MAX VISCOSITY (cP)
XL SERIES, MANUAL SPEED CONTROL: PVC pump head, PTFE diaphragm, PTFE O-Rings, ceramic check balls (* indicates FKM diaphragm/O-Rings)						
106188MVA4NJ	DDE 60-10 B-PVC/V/C-F-31A7A7BG*	379	145	3/4" NPT(M)	800:1	100
106188NBA4NH	DDE 120-7 B-PVC/T/C-F-31A7A7BG	768	101	3/4" NPT(M)	800:1	100
106188NDA4BN	DDE 200-4 B-PVC/T/C-F-31A7A7BG	1267	58	3/4" NPT(M)	800:1	100
S SERIES, MANUAL SPEED CONTROL: PVC pump head, PTFE diaphragm, PTFE O-Rings, ceramic check balls, installation kit (foot valve, injection valve, PE discharge, suction tubing)						
106188AEA4ED	DDE 6-10 B-PVC/T/C-X-31I003BG	36	150	1/4" Tube OD	1000:1	50
106188A0A4BR	DDE 15-4 B-PVC/T/C-X-31I004BG	95	60	1/2" Tube OD	1000:1	50
XL SERIES AR: pulse input/4-20 mA input, PVC pump head, PTFE diaphragm, PTFE O-Rings, ceramic check balls						
106182MVA4NJ	DDE 60-10 AR-PVC/T/C-F-31A7A7B	379	145	3/4" NPT(M)	800:1	100
106182NBA4NH	DDE 120-7 AR-PVC/T/C-F-31A7A7B	768	101	3/4" NPT(M)	800:1	100
106182NDA4BN	DDE 200-4 AR-PV/T/C-F-31A7A7BG	1267	58	3/4" NPT(M)	800:1	100
S SERIES PR: pulse input/4-20 mA input, PVC pump head, PTFE diaphragm, PTFE O-Rings, ceramic check balls, Installation kit (foot valve, injection valve, PE discharge, suction tubing)						
106198AEA4ED	DDE 6-10 PR-PVC/T/C-X-31I003BG	36	150	1/4" Tube OD	1000:1	50
106198A0A4BR	DDE 15-4 PR-PVC/T/C-X-31I004BG	95	60	1/2" Tube OD	1000:1	50
XL SERIES MANUAL SPEED CONTROL: PVDF pump head, PTFE diaphragm, PTFE O-Rings, ceramic check balls—can be used to dose sodium hypochlorite						
106188MVA5NJ	DDE 60-10 B-PV/T/C-F-31A7A7BG	379	145	3/4" NPT(M)	800:1	100
106188NBA5NH	DDE 120-7 B-PV/T/C-F-31A7A7BG	768	101	3/4" NPT(M)	800:1	100
106188NDA5BN	DDE 200-4 B-PV/T/C-F-31A7A7BG	1267	58	3/4" NPT(M)	800:1	100
S SERIES, MANUAL SPEED CONTROL: PVDF pump head, PTFE diaphragm, PTFE O-Rings, ceramic check balls Installation Kit (foot valve, injection valve, PE discharge, suction and deaeration tubing)—can be used to dose sodium hypochlorite						
106188AEA5ED	DDE 6-10 B-PV/T/C-X-31I003BG	36	150	1/4" Tube OD	1000:1	50
106188A0A5BR	DDE 15-4 B-PV/T/C-X-31I004BG	95	60	1/2" Tube OD	1000:1	50
XL SERIES AR: pulse input/4-20 mA input, PVDF pump head, PTFE diaphragm, PTFE O-Rings, ceramic check balls—can be used to dose sodium hypochlorite						
106182MVA5NJ	DDE 60-10 AR-PV/T/C-F-31A7A7BG	379	145	3/4" NPT(M)	800:1	100
106182NBA5NH	DDE 120-7 AR-PV/T/C-F-31A7A7BG	768	101	3/4" NPT(M)	800:1	100
106182NDA5BN	DDE 200-4 AR-PVC/T/C-F-31A7A7B	1267	58	3/4" NPT(M)	800:1	100
S SERIES PR: pulse input/4-20 mA input, PVDF pump head, PTFE diaphragm, PTFE O-Rings, ceramic Check balls, installation kit, (foot valve, injection valve, PE discharge, suction and deaeration tubing)—can be used to dose sodium hypochlorite						
106198AEA5ED	DDE 6-10 PR-PV/T/C-X-31I003BG	36	150	1/4" Tube OD	1000:1	50
106198A0A5BR	DDE 15-4 PR-PV/T/C-X-31I004BG	95	60	1/2" Tube OD	1000:1	50



Grundfos SMART DDA Digital S & XL Series Chemical Feed Pumps

These SMART DDA Digital S and XL Pumps are the perfect solution for complex and demanding applications. Thanks to the auto-deaeration feature it handles degassing liquids without any problems. Unlike pumps that rely on stroke length/frequency adjustment with solenoid drives, the DDA S and XL pumps feature a powerful variable-speed stepper motor with internal stroke speed control for smooth, continuous dosing and impressive turndown ratios.

With SMART Digital, dosing degassing or high-viscosity liquids is a breeze. The auto-deaeration feature offered by several models (include deaeration tubing) means that degassing chemicals do not result in vapor lock which can block the dosing process. The SlowMode feature on all models allow high-viscosity liquids to be dosed without clogging the pump. From intuitive wheel and button interfaces to clear, backlit navigation menus, SMART Digital pumps are very easy to set up and operate. Robust pump components such as the full-PTFE diaphragm provide long, reliable operation before service is required.

FEATURES & BENEFITS

- Accurate, stepper and permanent magnet synchronous motor technology
- Ideal for high-flow and high-accuracy applications such as polymer dosing
- User-friendly, intuitive wheel and button interfaces
- SlowMode (anti-cavitation) feature—dose high-viscosity liquids without clogging the pump
- Scalable analog input signal
- Mount pump on horizontal or vertical surfaces

SPECIFICATIONS

MODEL	S SERIES	XL SERIES
ACCURACY	±1%	±1.5%
SUCTION LIFT (ft)	20	10
POWER	100 to 240 VAC, 50/60 Hz, Single Phase	
INPUT	External Stop, Pulse Control, 0/4 to 20 mA, Low Level, Empty Tank	
OUTPUT	2 Relays and 0/4 to 20 mA	

CERTIFICATIONS

- UL, cUL, CSA



C&M PART #	MFG PART #	MAX FLOW (GPD)	MAX PRESSURE (PSI)	CONNECTION	TURNDOWN RATIO	MAX VISCOSITY (cP)
S SERIES: alarm relay, cable for pulse input/4 to 20 mA input, installation kit (foot valve, injection valve, PE discharge, suction and deaeration tubing), PVC pump head, PTFE diaphragm, PTFE O-Rings, ceramic check balls						
106168AUA4ED	DDA 7.5-16 AR-PVC/T/C-F-311003	48	150	1/4" Tube OD	3000:1	50
106168CHA4ED	DDA 12-10 AR-PVC/T/C-F-311004B	76	150	1/2" Tube OD	1000:1	300
106168MPA4DG	DDA 17-7 AR-PVC/T/C-F-311004BG	108	100	1/2" Tube OD	1000:1	300
106168MSA4BR	DDA 30-4 AR-PVC/T/C-F-311004BG	192	60	1/2" Tube OD	1000:1	150
S SERIES: alarm relay, cable for pulse input/4 to 20 mA input, installation kit (foot valve, injection valve, PE discharge, suction and deaeration tubing), PVDF pump head, PTFE diaphragm, PTFE O-Rings, ceramic check balls— can be used to dose sodium hypochlorite						
106168AUA5ED	DDA 7.5-16 AR-PV/T/C-F-311003B	48	232	1/4" Tube OD	3000:1	50
106168CHA5ED	DDA 12-10 AR-PV/T/C-F-311004BG	76	150	1/2" Tube OD	1000:1	300
106168MPA5DG	DDA 17-7 AR-PV/T/C-F-311004BG	108	100	1/2" Tube OD	1000:1	300
106168MSA5BR	DDA 30-4 AR-PV/T/C-F-311004BG	192	60	1/2" Tube OD	1000:1	150
XL SERIES: alarm relay, cable for pulse input/4 to 20 mA input, PVC pump head, PTFE diaphragm, PTFE O-Rings, ceramic check balls						
106176MVA4NJ	DDA 60-10 AR-PVC/T/C-F-31A7A7BG	379	145	3/4" NPT(M)	800:1	100
106176NBA4NH	DDA 120-7 AR-PVC/T/C-F-31A7A7B	768	101	3/4" NPT(M)	800:1	100
106176NDA4BN	DDA 200-4 AR-PVC/T/C-F-31U3U3F	1267	58	3/4" NPT(M)	800:1	100
XL SERIES: alarm relay, cable for pulse input/4 to 20 mA input, PVDF pump head, PTFE diaphragm, PTFE O-Rings, ceramic check balls— can be used to dose sodium hypochlorite						
106176MVA5NJ	DDA 60-10 AR-PV/T/C-F-31A7A7BG	379	145	3/4" NPT(M)	800:1	100
106176NBA5NH	DDA 120-7 AR-PV/T/C-F-31A7A7BG	768	101	3/4" NPT(M)	800:1	100
106176NDA5BN	DDA 200-4 AR-PV/T/C-F-31A7A7BG	1267	58	3/4" NPT(M)	800:1	100

Grundfos Chemical Feed Pump Repair Kits & Cable Accessory

Grundfos repair kits include check valves, diaphragm and compression fittings.

C&M PART #	MFG PART #	GRUNDFOS VALVE/DIAPHRAGM KIT
106202	97751485	SD-S-PVC/T/C DDE 6-10 & DDA 7.5-16, PVC/Teflon®
106203	97751539	SD-S-PV/T/C-DDE 6-10 & DDA 7.5-16, PVDF/Teflon
106204	97751503	SD-M-PVC/T/C DDE 15-4, DDA 12-10 & DDA 17-7, PVC/Teflon
106205	97751557	SD-L-PV/T/C-DDA 30-4 PVDF/ Teflon
106206	99151277	SD-XS-1--PVC/T/C-1, DDA & DDE 60-10 PVDF/Teflon
106207	99151315	DDE & DDA 120-7, PVC/Teflon
106208	99151318	SD-XM-1-PV/T/C-1 DDE & DDA 120-7 PVDF/Teflon
106209	99151343	DDE & DDA 200-4 PVC/Teflon
106210	99151346	SD-XL-1-PV/TC-1 DDE & DDA 200-4 PVDF/Teflon
CABLE ACCESSORY		
106211	96609016	4-Pole M12 5M Cable Socket 2+4 Analog Input/Ext Stop Cable

Pulsafeeder® BLACKLINE Chemical Feed Diaphragm Pumps



Without VFD



With VFD

The motor driven BLACKLINE Series MD Pumps feature a spring return mechanical diaphragm for precise and accurate metering control. The oil lubricated ball bearings in an anodized aluminum housing and rugged double-sided PTFE-faced diaphragm provide long service life. Micrometer style stroke length adjuster provides 10:1 turndown ratio manually; select pumps with VFD vector drive to obtain up to 100:1 turndown ratio.

SPECIFICATIONS

PUMP TYPE	MD1A, MD1B, MD2F	MD1D, MD3G
MAX VISCOSITY (cP)	1000	500
SUCTION LIFT (ft)	5*	
TURNDOWN RATIO	Manual - 10:1	
	With VFD Vector Drive - 100:1	
ACCURACY	±2%	
POWER	110/240 VAC**	
SHIPPING WEIGHT	62 to 92 lbs	

*With higher flow rates of these pumps, hard-piped and flooded-suction configuration is recommended.

**Alternate voltages available; contact us for more options.

C&M PART #	MFG PART #	MAX FLOW (GPD)	MAX PRESSURE (PSI)	CONNECTION NPT(F)	DIAPHRAGM KITS
BLACKLINE MD CHLORINE AND GENERAL CHEMICAL PUMP WITHOUT VFD					
10551919EIED	MDIAKTPNIA-XXX PVDF	168	150	1/2"	DIA-AE-1
10551919MUED	MDIBKTPNIA-XXX PVDF	336	150	1/2"	DIA-AE-1
10551919NAED	MDIDKTPNIA-XXX PVDF	696	150	1/2"	DIA-AE-1
10551919NEED	MD2FKTPNIA-XXX PVDF	1416	150	1/2"	DIA-FK-1
10551919NGED	MD3GKTPNIA-XXX PVDF	3168	150	1/2"	DIA-G-1
BLACKLINE MD CHLORINE AND GENERAL CHEMICAL PUMP WITH VFD					
10621219EIED	MDIAKTPN2C-XXX PVDF - VFD	168	150	1/2"	DIA-AE-1
10621219MUED	MDIBKTPN2C-XXX PVDF - VFD	336	150	1/2"	DIA-AE-1
10621219NAED	MDIDKTPN2C-XXX PVDF - VFD	696	150	1/2"	DIA-AE-1
10621219NEED	MD2FKTPN2C-XXX PVDF - VFD	1416	90	1/2"	DIA-FK-1
10621219NGED	MD3GKTPN2C-XXX PVDF - VFD	3168	75	1/2"	DIA-G-1
BLACKLINE MD POLYMER PUMP WITHOUT VFD					
10552419EIED	MDIAAASNIA-XXX SS	168	150	1/2"	DIA-AE-1
10552419MUED	MDIBAASNIA-XXX SS	336	150	1/2"	DIA-AE-1
10552419NAED	MDIDAASNIA-XXX SS	696	150	1/2"	DIA-AE-1
10552424NECW	MD2FAASNIA-XXX SS	1416	150	1/2"	DIA-FK-1
10552424NGCG	MD3GAASNIA-XXX SS	3168	150	1/2"	DIA-G-1
BLACKLINE MD POLYMER PUMP WITH VFD					
10621719EIED	MDIAAASN2C-XXX SS - VFD	168	150	1/2"	DIA-AE-1
10621719MUED	MDIBAASN2C-XXX SS - VFD	336	150	1/2"	DIA-AE-1
10621719NAED	MDIDAASN2C-XXX SS - VFD	696	150	1/2"	DIA-AE-1
10621724NECW	MD2FAASN2C-XXX SS - VFD	1416	90	1/2"	DIA-FK-1
10621724NGCG	MD3GAASN2C-XXX SS - VFD	3168	75	1/2"	DIA-G-1

REPLACEMENT PARTS & ACCESSORIES

C&M PART #	MFG PART #	DESCRIPTION
401968	DIA-AE-1	Diaphragm Kit, O-Rings/Slide Gasket
401969	DIA-FK-1	Diaphragm Kit, O-Rings/Slide Gasket
401970	DIA-G-1	Diaphragm Kit, O-Rings/Slide Gasket

Pulsafeeder Pulse Output Water Meters

Use these Pulsafeeder MultiJet Water Meters to remotely control the dosing rate of chemical feed pumps that accept a pulse input signal. Water meters provide a pulse output signal proportional to the water flow passing through the meter. Both brass and plastic water meters can be used for potable water.

FEATURES & BENEFITS

- Changing pulse rate requires no special tools
- Calibration plug seal wire for tamper evidence
- Totalizing register

INCLUDES

Meter couplings



SPECIFICATIONS

ACCURACY	±1.5%
MAX PRESSURE (PSI)	150

C&M PART #	MFG PART #	GALLONS PER CONTACT	CONNECTION NPT(M)	MAX FLOW (GPD)
BRASS WATER METERS				
1112542401	MTR104-G	1	3/4"	20
1112542402	MTR107-G	10	3/4"	20
1112543001	MTR304-G	1	1"	50
1112543002	MTR307-G	10	1"	50
1112543003	MTR310-G	100	1"	50
1112544001	MTR404-G	1	1-1/2"	100
1112544002	MTR407-G	10	1-1/2"	100
1112544003	MTR410-G	100	1-1/2"	100
1112545001	MTR504-G	1	2"	160
1112545002	MTR507-G	10	2"	160
1112545003	MTR510-G	100	2"	160
PLASTIC WATER METERS				
1112652401	MTR104-P	1	3/4"	20
1112652402	MTR107-P	10	3/4"	20
1112653001	MTR304-P	1	1"	50
1112653002	MTR307-P	10	1"	50
1112654001	MTR404-P	1	1-1/2"	100
1112654002	MTR407-P	10	1-1/2"	100

Integrated Chemical Metering Skid Systems

Recognizing the detrimental impact of downtime on manufacturing processes, this Integrated Chemical Metering platform was developed to address this challenge. The solution entails a remarkably adaptable, pre-plumbed system that facilitates the addition of pumps either on-site or through pre-installation and testing before delivery. This methodology expedites the installation process while maintaining the system's reliability and its effectiveness across various water treatment applications.

This platform, comprising simplex and duplex metering pump packages, provides unparalleled flexibility, convenience, and swift delivery. These packages are exceptionally well-suited for enhancing reliability in diverse water treatment applications.

The methodology empowers users to obtain pre-plumbed systems and customize them by adding pumps on-site. Alternatively, the customer can choose their preferred brand of metering pump/s, which can be installed and tested before delivery.

The control panel options offer users a range of sophistication, including:

- Simple Terminal Box (TB) for signal wire routing.
- Local Control Panel One (LCP1) - Provides terminal routing and incorporates dual MOA switches with a power cord and breakers.
- Local Control Panel Two (LCP2) - Adds power and run lights, along with a power disconnect to the LCP1.

FEATURES & BENEFITS

- Simplex & Duty / Standby Duplex Configuration
- Pre-Packaged and Tested
- Ready to Install- Plug N' Play
- Reduces Hassle & Labor
- Expandable Choices and Sophistication
- Flexible Control Options
- Select Any Metering Pump Brand
- Output Range—1- 20 gallons per hour



401995

SPECIFICATIONS

C&M PART #	401995	401996	401997	401998
UNIT TYPE	Simplex Floor Mounted		Duplex Floor Mounted	
DIMENSIONS (W x D x H)	20" x 18" x 40"		44" x 20" x 46"	
PUMPS	1 (Sold Separately or Customer Supplied)		2 (Sold Separately or Customer Supplied)	
PIPING	SCH80 PVC with Solvent Welded Fittings, Threaded Fittings only Required for Serviceability, System Ball Valves have True Union Ends with Standard Ball			
SEALS	FKM			
PRODUCT INLET HEADER	N/A		Includes: 1/2" Piping, Valves and Fittings; Inlet Isolation Valve; 250ml PVC Calibration Column with Isolation Valve; 1/2" FNPT Skid Termination	
PUMP SUCTION HEADER	Includes: 1/2" Piping, Valves and Fittings; Inlet Isolation Valve; Y-Strainer; 100ml PVC Calibration Column with Isolation Valve; Drain Valve with Plug; TEE with PRV Vent Return; 1/2" FNPT Skid Termination		Includes: 1/2" Piping, Valves and Fittings; Pump Isolation Valve; Drain Valve with Plug; Tee with PRV Vent Return	
PUMP DISCHARGE HEADER	Includes: 1/2" Piping, Valves and Fittings; PVC PRV Vent Return to Pump Suction; Drain Valve with Plug; 0-160 PSI Pressure Gauge, PVC Isolator and Isolation Ball Valve; PVC Back Pressure Valve; Discharge Isolation Valve; 1/2" FNPT Skid Termination		Includes: 1/2" Piping, Valves and Fittings; (2) PVC PRV Vent Return to Pump Suction; Pump Isolation Valve; Drain Valve with Plug	
SKID DISCHARGE HEADER	N/A		Includes: 1/2" Piping, Valves and Fittings; 0-160 PSI Pressure Gauge, PVC Isolator and Isolation Ball Valve; PVC Back Pressure Valve; Discharge Isolation Valve; 1/2" FNPT Skid Termination	
PUMP POWER RECEPTACLE	Standard 120VAC Receptacle with Protective Cover, Standard 120VAC US Line Cord, (Breaker Protection by Others)			
SKID BASE	HDPE Construction with Integral 1/2" Drip Lip, Two Pump Risers with all Required			
VENTED VALVES	No	Yes	No	Yes

Continued on Next Page



Integrated Chemical Metering Skid Systems *(continued)*

INCLUDES

One Piece Base & Back Plane, Two Plug Receptacle GFI Protected (Optional for the Simplex Skid), Inlet Isolation Valve, Suction Header -Pump Isolation Valves, Calibration Assembly with Isolation Valve, NPT Inlet / Outlet Connections, Pump Pedestals, Discharge Isolation Valve, Discharge Header- Pump isolation Valves, Pressure Gauge with Guard & Isolation, Back pressure valve (50 psi), Optional 1/2" PVC Inlet Y -Strainer, Optional Pressure Relief Valve

C&M PART #	MFG PART #	DESCRIPTION
401995	M200-CMPS	Simplex Feed Skid Unit
401996	M200-CMPS-V	Simplex Feed Skid Unit with Vented Valve
401997	M200-CMPD	Duplex Main/Standby Skid Unit
401998	M200-CMPD-V	Duplex Main/Standby Skid Unit with Vented Valve

ORDERING

Tailored configurations provide features such as feed verification, automatic switchover, and the option to integrate on-board controllers or timer packages. Installation and startup services are also available for these systems.

Due to the many options that are offered with these skid units, please call Core & Main Supply at 1-888-885-2673 and talk with our Product Specialist Team about available options and pricing.



401996

Options to know before you call:

- Select your Configuration: (Simplex Unit, Duplex Unit)
- Who will Supply the Pump: (Use Your own Pump, Purchase Pump with the Unit)
- Type of Pipe to be Used: (CPVC, PVC, Stainless Steel Tube, PVDF Kynar)
- Select Pipe Size: (1/2", 3/4")
- Select Pump Manufacturer: (Grundfos, LMI, Pulsafeeder, Stenner, Other)
- Select Calibration Column Size: (250 ml, 500 ml, 1000 ml, 2000 ml)
- Select Elastomer Type: (Viton, EPDM, Teflon)
- Include Wye Strainer: (Yes/No)
- Include Pressure Relief Valve: (Yes/No)
- Include Vented Ball Valve: (Yes/No)
- Include Pulsation Dampener: (Yes/No)
- Select Type of Control Box: (No Control Box, Terminal Box, Local Control Panel, Local Control Panel with Auto Switchover)

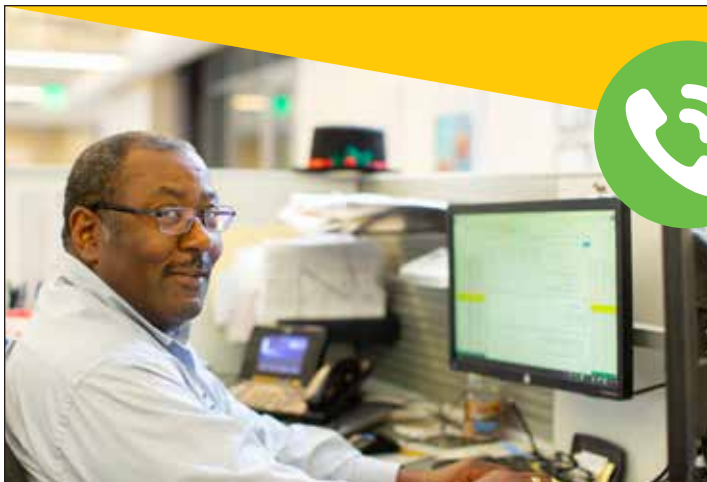

TALK TO AN EXPERT TODAY!

Need application advice or help to locate a part? Contact our technical specialists, they are here to help!

1-888-885-2673

Tempest 2.0 Polymer Feed System

The Tempest 2.0 Series of Polymer Feed and Control Stations provide the right type of mixing energy at the critical moment of initial wetting and tapers that energy through a multistage regime of hydrating zones. The net result is a fully hydrated polymer solution with maximum charge site exposure which ensures optimized polymer usage and performance. The design eliminates unwanted agglomerations, plugging and the costly mess of dealing with these issues.

The updated design of the Tempest 2.0 has proven to be an economical solution to the numerous challenges encountered in a broad range of municipal and industrial applications. This new design integrates leading edge control technologies, expanded application capabilities, on-screen digital real-time display of your critical application parameters, operational manual, wiring diagrams, graphing, tank level monitoring, greater available I/O and seamless access to any cloud-based data acquisition system. Additional features include an Endress + Hauser magnetic flow meter with totalizer to precisely control flow rates and a Grundfos DDA Series pump as standard. The Grundfos DDA is a compact, positive displacement, variable-speed (stepper motor) pump that operates at full stroke length to ensure optimum accuracy, priming and suction for high-viscosity polymers.

Modular design allows you to select the system that best fits your current needs while protecting your investment by allowing field upgrades to enhance control or increase system output. The Tempest 2.0 features various standard modes of operation, both local and remote: in local mode select to feed based on % concentration or polymer feed rate by simply pressing the button under the start icon on the menu. Use the 4 to 20 mA signal to control the % concentration or polymer feed rate remotely. When in remote mode use the remote start/stop dry contact input to initiate and stop dosing.

FEATURES & BENEFITS

- Critical performance data collection, one minute frequency data logging up to 90 days includes SD card easily transferred to PC
- On screen data logging and graphing
- Simpler programming via superior menu navigation
- Open architecture provided easy access to all components for easy maintenance
- Proven, motorless, multiple stage mixing optimizes hydration and activation
- Controller calculates and holds solution concentration.
- Neat polymer pump is paced to dilution water flow for consistent solution concentration
- Integrated batch system program
- Local and remote operation
- Easily view the mixing chamber



SPECIFICATIONS

POWER	115 VAC
INPUT	4 to 20 mA Dilution Water Flow Meter, 4 to 20 mA Remote % Concentrate / Feed Rate Input, (1) Digital Remote Start/Stop, (1) Digital Polymer Pump Alarm, (2) Reserved for Digital Batch Control Capability, (4) Digital Spare Inputs
OUTPUT	4 to 20 mA Polymer Pump Feed Rate Control, (2) Relay Outputs (dilute water solenoid valve and general alarm), (2) Reserved for Digital Batch Control Capability, (4) Spare Digital Relay Outputs
WETTED MATERIALS	Water: PVC, Brass, Bronze, Buna N, Acrylic, 316 SS Polymer: PVC, Acrylic, PTFE, PP, 316 SS
DIMENSIONS (W x H x D)	30" x 60" x 36"
WEIGHT (lbs)	260 (Shipping Weight), 190 (Unit Weight)

C&M PART #	MFG PART #	NEAT POLYMER OUTPUT RANGE (GPH)	PRIMARY DILUTION WATER FLOW RANGE (GPH)	MAX INLET PRESSURE (PSI)	WATER INLET NPT(F)	POLYMER INLET NPT(F)	SOLUTION OUTLET NPT(F)
TEMPEST 2.0 POLYMER FEED SYSTEMS WITH GRUNDFOS® DDA PUMP							
401698	TPSG2300-2.0	0.02 to 2.0	30 to 300	100	1"	1/2"	1"
401699	TPSG2600-4.5	0.02 to 4.5	60 to 600	100	1"	1/2"	1"
401700	TPSG21200-4.5	0.04 to 4.5	120 to 1200	100	1-1/2"	1/2"	1-1/2"
401701	TPSG21200-15.8	0.02 to 15.8	120 to 1200	100	1-1/2"	1/2"	1-1/2"

Tempest 1.0 Polymer Feed System

The Tempest 1.0 Series Polymer Feed and Control Stations provide maximized polymer performance without the hassles and headaches these applications cause for water treatment professionals. The system provides the right type of mixing energy at the critical moment of initial wetting, and tapers that energy through a multistage regime of hydrating zones. The net result is a fully hydrated polymer solution with maximum charge site exposure which ensures optimized polymer usage and performance. The design eliminates unwanted agglomerations, plugging and the costly mess of dealing with these issues.

To use, simply enter the desired polymer concentration and select manual or automatic operation. Primary dilution water flow, controlled by a solenoid valve, allows water to enter the unit. Primary dilution water flow rate data is measured continuously to ensure adequate flow is present and fed back to the Tempest controller. Using calculations derived from the calibration stage, the unit automatically adjusts the polymer pump output to achieve the desired concentration. Under conditions of high or low concentration, a loss of water flow or polymer feed (optional) the system automatically shuts down and notifies with an alarm. Each feed cycle is followed by an adjustable, multi-stage flush cycle to eliminate any plugging. The system can be operated remotely via a 4 to 20mA or simple on/off signal.

The controller limits the ability to make too high or too low a solution and protects against system upsets and gelling up the blending system. The neat polymer pump is paced to dilution water flow for consistent solution concentration. Controller provides water flow and concentration set point readout. Touchpad controller with 3-line LCD display makes mode selection simple with concise, easy to use menu.

FEATURES & BENEFITS

- Motorless, multistage mixing
- Hydro-kinetic disperser
- Easily view the mixing chamber
- Polymer paced to water flow
- Adjustable flushing cycle
- Concentration set-point
- Local and remote operation (feed rate & solution concentration control)



SPECIFICATIONS

POWER	115 VAC
INPUTS	4 to 20 mA Pump Speed, Remote Start Relay
OUTPUTS	(2) Contact Closure (General Alarm & System Running)
WETTED MATERIALS	Water: PVC, Brass, Bronze, Buna N, Acrylic, 316 SS Polymer: PVC, Acrylic, PTFE, PP, 316 SS
PUMP	LMI (included)

C&M PART #	MFG PART #	NEAT POLYMER OUTPUT RANGE (GPH)	PRIMARY DILUTION WATER FLOW RANGE (GPH)	MAX INLET PRESSURE (PSI)	WATER INLET NPT(F)	POLYMER INLET NPT(F)	SOLUTION OUTLET NPT(F)
TEMPEST 1.0 POLYMER FEED SYSTEM, LMI PUMP							
401685	TPS-60-D.4	0.04 to 0.40	6 to 60	100	1"	3/4"	1"
401686	TPS-60-D1	0.10 to 1.00	6 to 60	100	1"	3/4"	1"
401687	TPS-150-D.4	0.04 to 0.40	15 to 150	100	1"	3/4"	1"
401688	TPS-150-D1	0.10 to 1.00	15 to 150	100	1"	3/4"	1"
401689	TPS-150-D2.5	0.25 to 2.50	15 to 150	100	1"	3/4"	1"
401690	TPS-150-D4	0.40 to 4.00	15 to 150	100	1"	3/4"	1"
401691	TPS-300-D1	0.10 to 1.00	30 to 300	100	1"	3/4"	1"
401692	TPS-300-D2.5	0.25 to 2.50	30 to 300	100	1"	3/4"	1"
401693	TPS-300-D4	0.40 to 4.00	30 to 300	100	1"	3/4"	1"
401694	TPS-600-D2.5	0.25 to 2.50	60 to 600	100	1"	3/4"	1"
401695	TPS-600-D4	0.40 to 4.00	60 to 600	75	1"	3/4"	1"
401696	TPS-1200-D4	0.40 to 4.00	120 to 1200	100	1-1/2"	3/4"	1-1/2"
401697	TPS-1200-D8	0.80 to 8.00	120 to 1200	75	1-1/2"	3/4"	1-1/2"

SUGGESTED PRODUCTS

Core & Main Settling Agent Concentrate

Settling Agent Concentrate is a cationic polymer flocculent formulated for easy clarification of waste water in industrial waste streams and municipal waste water treatment facilities. It uses high molecular-weight polymers for the rapid settling of solids and suspended debris, which in turn helps to increase the capacity of waste-handling systems. It is non-toxic and will not harm fish or wildlife when used as directed.

FEATURES & BENEFITS

- Reducing operating costs
- Nontoxic, biodegradable formula
- Ideal for use on Primary and Secondary Clarifiers, Clarifiers, Settling Ponds, Basins and Reservoirs

C&M PART #	PACKAGE SIZE	QUANTITY
401174	1 Gallon	Pack of 4
401175	5 Gallons	1 Each
401176	35 Gallons	1 Each
401177	55 Gallons	1 Each



Ohaus® Defender™ 3000 Drum Scales



The Defender 3000 Drum Scales are durable portable floor scales designed for municipal and industrial plant applications. These low-profile scales feature front and rear access ramps for easy loading/unloading. Durable painted steel platform with treads withstands heavy industrial use and feature four load cells with alloy steel feet and top height adjustment. Digital backlit indicator is easy to see even at a distance. Conveniently transport the scale to wherever you need it by turning the scale on its side using the stainless-steel handles and rolling it using the two built-in wheels.

FEATURES & BENEFITS

- Modes include weighing, parts counting, check weighing, accumulation and dynamic/display hold
- Low-profile design with front and back access ramps for easy loading
- Powder coated carbon steel with raised tread for increased traction
- Easy access communication port including RS-232 communication interface
- AC adapter with auto shut-off feature

INCLUDES

Drum scale, digital indicator, 20-ft L indicator cord and AC adapter

C&M PART #	MFG PART #	MAX CAPACITY (lbs)	READABILITY (lbs)	PLATFORM SIZE	POWER
706042	30469909	500	0.1	30" x 30"	100 to 240 VAC, 50/60 Hz
706039	30469910	1000	0.2	30" x 30"	100 to 240 VAC, 50/60 Hz
706041	30469911	2500	0.5	30" x 30"	100 to 240 VAC, 50/60 Hz
706038	30469912	1000	0.2	36" x 36"	100 to 240 VAC, 50/60 Hz
706040	30469913	2500	0.5	36" x 36"	100 to 240 VAC, 50/60 Hz

Ohaus® Defender™ 3000 Floor Scales

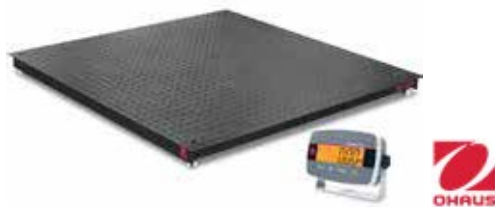

The Defender 3000 Floor Scales are perfect for weighing large drums and totes in municipal and industrial plants. Their high-quality construction is designed to minimize flexing under heavy loads for years of dependable performance. Operation modes include counting, totalization and checkweighing; display changes color (yellow/green/red) to indicate if the weight is within the target range in the checkweighing mode. Top access to foot height adjustment screws makes leveling easy.

FEATURES & BENEFITS

- Modes include weighing, parts counting, checkweighing and totalization
- View the results on a large, bright backlit LCD
- Communication abilities include standard RS232 and optional USB device or Ethernet
- Powder coated carbon steel with raised tread for increased traction

INCLUDES

Floor scale, digital indicator, indicator card and power supply

POWER

100-240 VAC, 50/60 Hz or (6) C cell battery (not included, 100-hour operation)

C&M PART #	MFG PART #	MAX CAPACITY (lbs)	READABILITY (lbs)	PLATFORM SIZE
401747	i-DF33P2500B1R	2500	0.5	36" x 36"
401748	i-DF33P2500B1L	2500	0.5	48" x 48"
401749	i-DF33P5000B1L	5000	1	48" x 48"
401750	i-DF33P5000B1X	5000	1	60" x 60"

Chemical Feed Tubing

Clear PVC Suction Tubing is commonly used transferring of fluids and gasses in low-pressure applications. Clear tubing allows for constant visibility on flow of chemicals through the tubing, enabling quick detection of impediments to flow. Tubing with wall thickness less than 0.250" (1/4") are compatible with gamma sterilization.

Linear Low-Density Polyethylene (LLDPE) Discharge Tubing is economical and suitable for many general purposes, including air, water and chemical transfer lines. LLDPE offers better flexibility and translucency compared to HDPE, and superior environmental stress cracking resistance compares to LDPE.

High-Density Polyethylene (HDPE) Tubing, like LLDPE tubing, can be used in applications like air, water and chemical transfer lines. HDPE has higher pressure and abrasion resistance than LLDPE and can be sterilized by boiling.

FEATURES & BENEFITS

- Manufactured with raw materials that meet FDA requirements
- Black tubing provides UV resistance, making it ideal for outdoor applications



Clear



HDPE

C&M PART #	MFG PART #	OUTSIDE DIAMETER (OD)	INSIDE DIAMETER (ID)	WALL THICKNESS	WORKING PRESSURE (PSI @ 70°F)	ROLL SIZE (ft)	COLOR
CLEAR PVC SUCTION TUBING							
1127115X2	0187-0312-062-01-03-00025	5/16"	3/16"	1/16"	55	25	Clear
1127117X2	0250-0375-062-01-03-00025	3/8"	1/4"	1/16"	55	25	Clear
1127104X2	0312-0437-062-01-03-00025	7/16"	5/16"	1/16"	50	25	Clear
1127119X2	0375-0500-062-01-03-00025	1/2"	3/8"	1/16"	45	25	Clear
1127124X2	0500-0750-125-01-03-00025	3/4"	1/2"	1/8"	45	25	Clear
1127115BC	0187-0312-062-01-03-00050	5/16"	3/16"	1/16"	50	50	Clear
1127117BC	0250-0375-062-01-03-00050	3/8"	1/4"	1/16"	55	50	Clear
1127104BC	0312-0437-062-01-03-00050	7/16"	5/16"	1/16"	50	50	Clear
1127119BC	0375-0500-062-01-03-00050	1/2"	3/8"	1/16"	45	50	Clear
1127124BC	0500-0750-125-01-03-00050	3/4"	1/2"	1/8"	45	50	Clear
1127115DG	0187-0312-062-01-03-00100	5/16"	3/16"	1/16"	55	100	Clear
1127117DG	0250-0375-062-01-03-00100	3/8"	1/4"	1/16"	55	100	Clear
1127104DG	0312-0437-062-01-03-00100	7/16"	5/16"	1/16"	50	100	Clear
1127119DG	0375-0500-062-01-03-00100	1/2"	3/8"	1/16"	45	100	Clear
1127124DG	0500-0750-125-01-03-00100	3/4"	1/2"	1/8"	45	100	Clear

C&M PART #	MFG PART #	OUTSIDE DIAMETER (OD)	INSIDE DIAMETER (ID)	WALL THICKNESS	WORKING PRESSURE (PSI @ 70°F)	ROLL SIZE (ft)	COLOR
LLDPE DISCHARGE TUBING—STANDARD							
1112861803X2	0500-0625-062-11-03-00025	5/8"	1/2"	1/16"	119	25	Translucent
1112861703X2	0500-0625-062-11-13-00025	5/8"	1/2"	1/16"	119	25	Black
1112861819X2	0375-0500-062-11-03-00025	1/2"	3/8"	1/16"	153	25	Translucent
1112861719X2	0375-0500-062-11-13-00025	1/2"	3/8"	1/16"	153	25	Black
1112861811X2	0170-0250-040-11-03-00025	1/4"	1/6"	1/12"	205	25	Translucent
1112861711X2	0170-0250-040-11-13-00025	1/4"	1/6"	1/12"	205	25	Black
1112861817X2	0250-0375-062-11-03-00025	3/8"	1/4"	1/16"	214	25	Translucent
1112861717X2	0250-0375-062-11-13-00025	3/8"	1/4"	1/16"	214	25	Black
1113161811X2	0125-0250-062-11-03-00025	1/4"	1/8"	1/16"	358	25	Translucent
1112861803BC	0500-0625-062-11-03-00050	5/8"	1/2"	1/16"	119	50	Translucent
1112861703BC	0500-0625-062-11-13-00050	5/8"	1/2"	1/16"	119	50	Black
1112861819BC	0375-0500-062-11-03-00050	1/2"	3/8"	1/16"	153	50	Translucent
1112861719BC	0375-0500-062-11-13-00050	1/2"	3/8"	1/16"	153	50	Black
1112861811BC	0170-0250-040-11-03-00050	1/4"	1/6"	1/24"	205	50	Translucent
1112861711BC	0170-0250-040-11-13-00050	1/4"	1/6"	1/24"	205	50	Black
1112861817BC	0250-0375-062-11-03-00050	3/8"	1/4"	1/16"	214	50	Translucent
1112861717BC	0250-0375-062-11-13-00050	3/8"	1/4"	1/16"	214	50	Black
1113161811BC	0125-0250-062-11-03-00050	1/4"	1/8"	1/16"	358	50	Translucent
1112861803DG	0500-0625-062-11-03-00100	5/8"	1/2"	1/16"	119	100	Translucent
1112861703DG	0500-0625-062-11-13-00100	5/8"	1/2"	1/16"	119	100	Black
1112861819DG	0375-0500-062-11-03-00100	1/2"	3/8"	1/16"	153	100	Translucent
1112861719DG	0375-0500-062-11-13-00100	1/2"	3/8"	1/16"	153	100	Black

Continued on Next Page



Chemical Feed Tubing *(continued)*

C&M PART #	MFG PART #	OUTSIDE DIAMETER (OD)	INSIDE DIAMETER (ID)	WALL THICKNESS	WORKING PRESSURE (PSI @ 70°F)	ROLL SIZE (ft)	COLOR
LLDPE DISCHARGE TUBING—STANDARD (CONTINUED)							
1112861811DG	0170-0250-040-11-03-00100	1/4"	1/6"	1/24"	205	100	Translucent
1112861711DG	0170-0250-040-11-13-00100	1/4"	1/6"	1/24"	205	100	Black
1112861817DG	0250-0375-062-11-03-00100	3/8"	1/4"	1/16"	214	100	Translucent
1112861717DG	0250-0375-062-11-13-00100	3/8"	1/4"	1/16"	214	100	Black
1113161811DG	0125-0250-062-11-03-00100	1/4"	1/8"	1/16"	358	100	Translucent
1112861819FD	0375-0500-062-11-03-S0500	1/2"	3/8"	1/16"	153	500	Translucent
1112861719FD	0375-0500-062-11-13-S0500	1/2"	3/8"	1/16"	153	500	Black
1112861811FD	0170-0250-040-11-03-S0500	1/4"	1/6"	1/24"	205	500	Translucent
1112861711FD	0170-0250-040-11-13-S0500	1/4"	1/6"	1/24"	205	500	Black
1112861817FD	0250-0375-062-11-03-S0500	3/8"	1/4"	1/16"	214	500	Translucent
1112861717FD	0250-0375-062-11-13-S0500	3/8"	1/4"	1/16"	214	500	Black
LLDPE DISCHARGE TUBING—NSF-61 CERTIFIED							
1113171803X2	0500-0625-062-13-03-00025	5/8"	1/2"	1/16"	119	25	Translucent
1113171819X2	0375-0500-062-13-03-00025	1/2"	3/8"	1/16"	153	25	Translucent
1113171817X2	0250-0375-062-13-03-00025	3/8"	1/4"	1/16"	214	25	Translucent
1113171811X2	0125-0250-062-13-03-00025	1/4"	1/8"	1/16"	358	25	Translucent
1113171803BC	0500-0625-062-13-03-00050	5/8"	1/2"	1/16"	119	50	Translucent
1113171819BC	0375-0500-062-13-03-00050	1/2"	3/8"	1/16"	153	50	Translucent
1113171817BC	0250-0375-062-13-03-00050	3/8"	1/4"	1/16"	214	50	Translucent
1113171811BC	0125-0250-062-13-03-00050	1/4"	1/8"	1/16"	358	50	Translucent
1113171803DG	0500-0625-062-13-03-00100	5/8"	1/2"	1/16"	119	100	Translucent
1113171819DG	0375-0500-062-13-03-00100	1/2"	3/8"	1/16"	153	100	Translucent
1113171817DG	0250-0375-062-13-03-00100	3/8"	1/4"	1/16"	214	100	Translucent
1113171811DG	0125-0250-062-13-03-00100	1/4"	1/8"	1/16"	358	100	Translucent
1113171817FD	0250-0375-062-13-03-S0500	3/8"	1/4"	1/16"	214	500	Translucent
1113171717FD	0250-0375-062-13-13-S0500	3/8"	1/4"	1/16"	214	500	Black

C&M PART #	MFG PART #	OUTSIDE DIAMETER (OD)	INSIDE DIAMETER (ID)	WALL THICKNESS	WORKING PRESSURE (PSI @ 70°F)	ROLL SIZE (ft)	COLOR
HDPE DISCHARGE TUBING—STANDARD							
1113331803X2	0500-0625-062-21-03-00025	5/8"	1/2"	1/16"	151	25	Translucent
1113331703X2	0500-0625-062-21-13-00025	5/8"	1/2"	1/16"	151	25	Black
1113331819X2	0375-0500-062-21-03-00025	1/2"	3/8"	1/16"	194	25	Translucent
1113331719X2	0375-0500-062-21-13-00025	1/2"	3/8"	1/16"	194	25	Black
1113331711X2	0170-0250-040-21-13-00025	1/4"	1/6"	1/24"	260	25	Black
1113331817X2	0250-0375-062-21-03-00025	3/8"	1/4"	1/16"	272	25	Translucent
1113331717X2	0250-0375-062-21-13-00025	3/8"	1/4"	1/16"	272	25	Black
1113331811X2	0125-0250-062-21-03-00025	1/4"	1/8"	1/16"	456	25	Translucent
1113331803BC	0500-0625-062-21-03-00050	5/8"	1/2"	1/16"	151	50	Translucent
1113331703BC	0500-0625-062-21-13-00050	5/8"	1/2"	1/16"	151	50	Black
1113331819BC	0375-0500-062-21-03-00050	1/2"	3/8"	1/16"	194	50	Translucent
1113331719BC	0375-0500-062-21-13-00050	1/2"	3/8"	1/16"	194	50	Black
1113331711BC	0170-0250-040-21-13-00050	1/4"	1/6"	1/24"	260	50	Black
1113331817BC	0250-0375-062-21-03-00050	3/8"	1/4"	1/16"	272	50	Translucent
1113331717BC	0250-0375-062-21-13-00050	3/8"	1/4"	1/16"	272	50	Black
1113331811BC	0125-0250-062-21-03-00050	1/4"	1/8"	1/16"	456	50	Translucent
1113331803DG	0500-0625-062-21-03-00100	5/8"	1/2"	1/16"	151	100	Translucent
1113331703DG	0500-0625-062-21-13-00100	5/8"	1/2"	1/16"	151	100	Black
1113331819DG	0375-0500-062-21-03-00100	1/2"	3/8"	1/16"	194	100	Translucent
1113331719DG	0375-0500-062-21-13-00100	1/2"	3/8"	1/16"	194	100	Black
1113331711DG	0170-0250-040-21-13-00100	1/4"	1/6"	1/24"	260	100	Black
1113331817DG	0250-0375-062-21-03-00100	3/8"	1/4"	1/16"	272	100	Translucent
1113331717DG	0250-0375-062-21-13-00100	3/8"	1/4"	1/16"	272	100	Black
1113331811DG	0125-0250-062-21-03-00100	1/4"	1/8"	1/16"	456	100	Translucent
1113331819FD	0375-0500-062-21-03-S0500	1/2"	3/8"	1/16"	194	500	Translucent
1113331817FD	0250-0375-062-21-03-S0500	3/8"	1/4"	1/16"	272	500	Translucent

Continued on Next Page



Chemical Feed Tubing (continued)

C&M PART #	MFG PART #	OUTSIDE DIAMETER (OD)	INSIDE DIAMETER (ID)	WALL THICKNESS	WORKING PRESSURE (PSI @ 70°F)	ROLL SIZE (ft)	COLOR
HDPE DISCHARGE TUBING—NSF-61 CERTIFIED							
1113591819X2	0375-0500-062-23-03-00025	1/2"	3/8"	1/16"	194	25	Translucent
1113591711X2	0170-0250-040-23-13-00025	1/4"	1/6"	1/24"	260	25	Black
1113591811X2	0170-0250-040-23-03-00025	1/4"	1/6"	1/24"	260	25	Translucent
1113591817X2	0250-0375-062-23-03-00025	3/8"	1/4"	1/16"	272	25	Translucent
1113591717X2	0250-0375-062-23-13-00025	3/8"	1/4"	1/16"	272	25	Black
1113591819BC	0375-0500-062-23-03-00050	1/2"	3/8"	1/16"	194	50	Translucent
1113591811BC	0170-0250-040-23-03-00050	1/4"	1/6"	1/24"	260	50	Translucent
1113591711BC	0170-0250-040-23-13-00050	1/4"	1/6"	1/24"	260	50	Black
1113591717BC	0250-0375-062-23-13-00050	3/8"	1/4"	1/16"	272	50	Black
1113591817BC	0250-0375-062-23-03-00050	3/8"	1/4"	1/16"	272	50	Translucent
1113591819DG	0375-0500-062-23-03-00100	1/2"	3/8"	1/16"	194	100	Translucent
1113591811DG	0170-0250-040-23-03-00100	1/4"	1/6"	1/24"	260	100	Translucent
1113591711DG	0170-0250-040-23-13-00100	1/4"	1/6"	1/24"	260	100	Black
1113591817DG	0250-0375-062-23-03-00100	3/8"	1/4"	1/16"	272	100	Translucent
1113591717DG	0250-0375-062-23-13-00100	3/8"	1/4"	1/16"	272	100	Black

SIGNS, TAGS, & LABELS



See our Signs, Tags, & Labels section starting on **page 385** for all your signage needs.

Tube Fittings

Jaco compression-style fitting, resistant to scale build up.

FEATURES & BENEFITS

- Nut with plastic gripper tightly grips rigid plastic tubing for leak-free operation
- Use with low strength acids and bases
- Not suitable for use with oxidants, strong acids and liquids with high concentrations of free chlorine



C&M PART #	MFG PART #	MATERIAL	CONFIGURATION	SIZE (in)	QUANTITY
A MALE CONNECTORS					
1081809725	10-4-4-P-PG	Polypropylene	Tube x NPT(M)	1/4 x 1/4	10/Pack
1081809726	10-4-6-P-PG	Polypropylene	Tube x NPT(M)	1/4 x 3/8	10/Pack
1081809727	10-6-4-P-PG	Polypropylene	Tube x NPT(M)	3/8 x 1/4	10/Pack
1081809728	10-6-6-P-PG	Polypropylene	Tube x NPT(M)	3/8 x 3/8	10/Pack
1081809729	10-6-8-P-PG	Polypropylene	Tube x NPT(M)	3/8 x 1/2	10/Pack
1081809730	10-8-4-P-PG	Polypropylene	Tube x NPT(M)	1/2 x 1/4	10/Pack
1081809731	10-8-6-P-PG	Polypropylene	Tube x NPT(M)	1/2 x 3/8	10/Pack
1081809732	10-8-8-P-PG	Polypropylene	Tube x NPT(M)	1/2 x 1/2	10/Pack
1081809733	10-10-6-P-PG	Polypropylene	Tube x NPT(M)	5/8 x 3/8	10/Pack
1081809734	10-10-8-P-PG	Polypropylene	Tube x NPT(M)	5/8 x 1/2	10/Pack
1081809735	10-12-8-P-PG	Polypropylene	Tube x NPT(M)	3/4 x 1/2	5/Pack
1081809736	10-12-12-P-PG	Polypropylene	Tube x NPT(M)	3/4 x 3/4	5/Pack
108192A525	10-4-4-K-PG	PVDF Kynar	Tube x NPT(M)	1/4 x 1/4	10/Pack
108192A526	10-4-6-K-PG	PVDF Kynar	Tube x NPT(M)	1/4 x 3/8	10/Pack
108192A527	10-6-4-K-PG	PVDF Kynar	Tube x NPT(M)	3/8 x 1/4	10/Pack
108192A528	10-6-6-K-PG	PVDF Kynar	Tube x NPT(M)	3/8 x 3/8	10/Pack
108192A529	10-6-8-K-PG	PVDF Kynar	Tube x NPT(M)	3/8 x 1/2	10/Pack
108192A530	10-8-4-K-PG	PVDF Kynar	Tube x NPT(M)	1/2 x 1/4	10/Pack
108192A531	10-8-6-K-PG	PVDF Kynar	Tube x NPT(M)	1/2 x 3/8	10/Pack
108192A532	10-8-8-K-PG	PVDF Kynar	Tube x NPT(M)	1/2 x 1/2	10/Pack
108192A533	10-10-6-K-PG	PVDF Kynar	Tube x NPT(M)	5/8 x 3/8	5/Pack
108192A534	10-10-8-K-PG	PVDF Kynar	Tube x NPT(M)	5/8 x 1/2	5/Pack
108192A535	10-12-8-K-PG	PVDF Kynar	Tube x NPT(M)	3/4 x 1/2	5/Pack
108192A536	10-12-12-K-PG	PVDF Kynar	Tube x NPT(M)	3/4 x 3/4	5/Pack
B MALE ELBOWS					
1082049725	40-4-4-P-PG	Polypropylene	Tube x NPT(M)	1/4 x 1/4	10/Pack
1082049726	40-4-6-P-PG	Polypropylene	Tube x NPT(M)	1/4 x 3/8	10/Pack
1082049727	40-6-4-P-PG	Polypropylene	Tube x NPT(M)	3/8 x 1/4	10/Pack
1082049728	40-6-6-P-PG	Polypropylene	Tube x NPT(M)	3/8 x 3/8	10/Pack
1082049730	40-8-4-P-PG	Polypropylene	Tube x NPT(M)	1/2 x 1/4	10/Pack
1082049731	40-8-6-P-PG	Polypropylene	Tube x NPT(M)	1/2 x 3/8	10/Pack
1082049732	40-8-8-P-PG	Polypropylene	Tube x NPT(M)	1/2 x 1/2	10/Pack
1082049734	40-10-8-P-PG	Polypropylene	Tube x NPT(M)	5/8 x 1/2	10/Pack

Continued on Next Page

Tube Fittings (continued)

C&M PART #	MFG PART #	MATERIAL	CONFIGURATION	SIZE (in)	QUANTITY
B MALE ELBOWS (CONTINUED)					
108204A525	40-4-4-K-PG	PVDF Kynar	Tube x NPT(M)	1/4 x 1/4	10/Pack
108204A526	40-4-6-K-PG	PVDF Kynar	Tube x NPT(M)	1/4 x 3/8	10/Pack
108204A527	40-6-4-K-PG	PVDF Kynar	Tube x NPT(M)	3/8 x 1/4	10/Pack
108204A528	40-6-6-K-PG	PVDF Kynar	Tube x NPT(M)	3/8 x 3/8	10/Pack
108204A530	40-8-4-K-PG	PVDF Kynar	Tube x NPT(M)	1/2 x 1/4	10/Pack
108204A531	40-8-6-K-PG	PVDF Kynar	Tube x NPT(M)	1/2 x 3/8	10/Pack
108204A532	40-8-8-K-PG	PVDF Kynar	Tube x NPT(M)	1/2 x 1/2	10/Pack
108204A534	40-10-8-K-PG	PVDF Kynar	Tube x NPT(M)	5/8 x 1/2	5/Pack
C MALE BRANCH TEES					
1082209701	60-4-4-P-PG	Polypropylene	Tube x Tube x NPT(M)	1/4 x 1/4 x 1/4	10/Pack
1082209702	60-6-4-P-PG	Polypropylene	Tube x Tube x NPT(M)	3/8 x 3/8 x 1/4	10/Pack
1082209703	60-6-6-P-PG	Polypropylene	Tube x Tube x NPT(M)	3/8 x 3/8 x 3/8	10/Pack
1082209704	60-8-6-P-PG	Polypropylene	Tube x Tube x NPT(M)	1/2 x 1/2 x 3/8	10/Pack
1082209705	60-8-8-P-PG	Polypropylene	Tube x Tube x NPT(M)	1/2 x 1/2 x 1/2	10/Pack
108220A501	60-4-4-K-PG	PVDF Kynar	Tube x Tube x NPT(M)	1/4 x 1/4 x 1/4	10/Pack
108220A502	60-6-4-K-PG	PVDF Kynar	Tube x Tube x NPT(M)	3/8 x 3/8 x 1/4	10/Pack
108220A503	60-6-6-K-PG	PVDF Kynar	Tube x Tube x NPT(M)	3/8 x 3/8 x 3/8	10/Pack
108220A504	60-8-6-K-PG	PVDF Kynar	Tube x Tube x NPT(M)	1/2 x 1/2 x 3/8	10/Pack
108220A505	60-8-8-K-PG	PVDF Kynar	Tube x Tube x NPT(M)	1/2 x 1/2 x 1/2	10/Pack
D UNIONS					
1082309706	15-4-P-PG	Polypropylene	Tube x Tube	1/4 x 1/4	10/Pack
1082309707	15-6-4-P-PG	Polypropylene	Tube x Tube	3/8 x 1/4	10/Pack
1082309708	15-6-P-PG	Polypropylene	Tube x Tube	3/8 x 3/8	10/Pack
1082309709	15-8-6-P-PG	Polypropylene	Tube x Tube	1/2 x 3/8	10/Pack
1082309710	15-8-P-PG	Polypropylene	Tube x Tube	1/2 x 1/2	10/Pack
1082309711	15-10-8-P-PG	Polypropylene	Tube x Tube	5/8 x 1/2	10/Pack
1082309712	15-10-P-PG	Polypropylene	Tube x Tube	5/8 x 5/8	10/Pack
1082309713	15-12-P-PG	Polypropylene	Tube x Tube	3/4 x 3/4	5/Pack
108230A506	15-4-K-PG	PVDF Kynar	Tube x Tube	1/4 x 1/4	10/Pack
108230A507	15-6-4-K-PG	PVDF Kynar	Tube x Tube	3/8 x 1/4	10/Pack
108230A508	15-6-K-PG	PVDF Kynar	Tube x Tube	3/8 x 3/8	10/Pack
108230A509	15-8-6-K-PG	PVDF Kynar	Tube x Tube	1/2 x 3/8	10/Pack
108230A510	15-8-K-PG	PVDF Kynar	Tube x Tube	1/2 x 1/2	10/Pack
108230A511	15-10-8-K-PG	PVDF Kynar	Tube x Tube	5/8 x 1/2	5/Pack
108230A512	15-10-K-PG	PVDF Kynar	Tube x Tube	5/8 x 5/8	5/Pack
108230A513	15-12-K-PG	PVDF Kynar	Tube x Tube	3/4 x 3/4	5/Pack

C&M PART #	MFG PART #	MATERIAL	CONFIGURATION	SIZE (in)	QUANTITY
E UNION TEES					
1082469721	70-4-P-PG	Polypropylene	Tube x Tube x Tube	1/4 x 1/4 x 1/4	10/Pack
1082469722	70-6-P-PG	Polypropylene	Tube x Tube x Tube	3/8 x 3/8 x 3/8	10/Pack
1082469723	70-8-P-PG	Polypropylene	Tube x Tube x Tube	1/2 x 1/2 x 1/2	10/Pack
1082469724	70-10-P-PG	Polypropylene	Tube x Tube x Tube	5/8 x 5/8 x 5/8	10/Pack
108246A521	70-4-K-PG	PVDF Kynar	Tube x Tube x Tube	1/4 x 1/4 x 1/4	10/Pack
108246A522	70-6-K-PG	PVDF Kynar	Tube x Tube x Tube	3/8 x 3/8 x 3/8	10/Pack
108246A523	70-8-K-PG	PVDF Kynar	Tube x Tube x Tube	1/2 x 1/2 x 1/2	10/Pack
108246A524	70-10-K-PG	PVDF Kynar	Tube x Tube x Tube	5/8 x 5/8 x 5/8	5/Pack
F BULKHEAD UNIONS					
1082549721	20-4-P-PG	Polypropylene	Tube x Tube	1/4 x 1/4	10/Pack
1082549722	20-6-P-PG	Polypropylene	Tube x Tube	3/8 x 3/8	10/Pack
1082549723	20-8-P-PG	Polypropylene	Tube x Tube	1/2 x 1/2	10/Pack
108254A521	20-4-K-PG	PVDF Kynar	Tube x Tube	1/4 x 1/4	10/Pack
108254A522	20-6-K-PG	PVDF Kynar	Tube x Tube	3/8 x 3/8	10/Pack
108254A523	20-8-K-PG	PVDF Kynar	Tube x Tube	1/2 x 1/2	10/Pack



Continued on Next Page

Tube Fittings (continued)

C&M PART #	MFG PART #	MATERIAL	CONFIGURATION	SIZE (in)	QUANTITY
G FEMALE CONNECTORS					
1082609714	25-4-4-P-PG	Polypropylene	Tube x NPT(F)	1/4 x 1/4	10/Pack
1082609715	25-6-4-P-PG	Polypropylene	Tube x NPT(F)	3/8 x 1/4	10/Pack
1082609716	25-6-6-P-PG	Polypropylene	Tube x NPT(F)	3/8 x 3/8	10/Pack
1082609717	25-6-8-P-PG	Polypropylene	Tube x NPT(F)	3/8 x 1/2	10/Pack
1082609718	25-8-6-P-PG	Polypropylene	Tube x NPT(F)	1/2 x 3/8	10/Pack
1082609719	25-8-8-P-PG	Polypropylene	Tube x NPT(F)	1/2 x 1/2	10/Pack
1082609720	25-10-8-P-PG	Polypropylene	Tube x NPT(F)	5/8 x 1/2	10/Pack
108260A514	25-4-4-K-PG	PVDF Kynar	Tube x NPT(F)	1/4 x 1/4	10/Pack
108260A515	25-6-4-K-PG	PVDF Kynar	Tube x NPT(F)	3/8 x 1/4	10/Pack
108260A516	25-6-6-K-PG	PVDF Kynar	Tube x NPT(F)	3/8 x 3/8	10/Pack
108260A517	25-6-8-K-PG	PVDF Kynar	Tube x NPT(F)	3/8 x 1/2	10/Pack
108260A518	25-8-6-K-PG	PVDF Kynar	Tube x NPT(F)	1/2 x 3/8	10/Pack
108260A519	25-8-8-K-PG	PVDF Kynar	Tube x NPT(F)	1/2 x 1/2	10/Pack
108260A520	25-10-8-K-PG	PVDF Kynar	Tube x NPT(F)	5/8 x 1/2	5/Pack
H FEMALE ELBOWS					
1082749714	45-4-4-P-PG	Polypropylene	Tube x NPT(F)	1/4 x 1/4	10/Pack
1082749715	45-6-4-P-PG	Polypropylene	Tube x NPT(F)	3/8 x 1/4	10/Pack
1082749716	45-6-6-P-PG	Polypropylene	Tube x NPT(F)	3/8 x 3/8	10/Pack
1082749718	45-8-6-P-PG	Polypropylene	Tube x NPT(F)	3/8 x 1/2	10/Pack
1082749719	45-8-8-P-PG	Polypropylene	Tube x NPT(F)	1/2 x 1/2	10/Pack
1082749720	45-10-8-P-PG	Polypropylene	Tube x NPT(F)	5/8 x 1/2	10/Pack
108274A514	45-4-4-K-PG	PVDF Kynar	Tube x NPT(F)	1/4 x 1/4	10/Pack
108274A515	45-6-4-K-PG	PVDF Kynar	Tube x NPT(F)	3/8 x 1/4	10/Pack
108274A516	45-6-6-K-PG	PVDF Kynar	Tube x NPT(F)	3/8 x 3/8	10/Pack
108274A518	45-8-6-K-PG	PVDF Kynar	Tube x NPT(F)	3/8 x 1/2	10/Pack
108274A519	45-8-8-K-PG	PVDF Kynar	Tube x NPT(F)	1/2 x 1/2	10/Pack
108274A520	45-10-8-K-PG	PVDF Kynar	Tube x NPT(F)	5/8 x 1/2	5/Pack

C&M PART #	MFG PART #	MATERIAL	CONFIGURATION	SIZE (in)	QUANTITY
I UNION ELBOWS					
1082869706	50-4-P-PG	Polypropylene	Tube x Tube	1/4 x 1/4	10/Pack
1082869708	50-6-P-PG	Polypropylene	Tube x Tube	3/8 x 3/8	10/Pack
1082869710	50-8-P-PG	Polypropylene	Tube x Tube	1/2 x 1/2	10/Pack
1082869712	50-10-P-PG	Polypropylene	Tube x Tube	5/8 x 5/8	10/Pack
1082869713	50-12-P-PG	Polypropylene	Tube x Tube	3/4 x 3/4	5/Pack
108286A506	50-4-K-PG	PVDF Kynar	Tube x Tube	1/4 x 1/4	10/Pack
108286A508	50-6-K-PG	PVDF Kynar	Tube x Tube	3/8 x 3/8	10/Pack
108286A510	50-8-K-PG	PVDF Kynar	Tube x Tube	1/2 x 1/2	10/Pack
108286A512	50-10-K-PG	PVDF Kynar	Tube x Tube	5/8 x 5/8	10/Pack
108286A513	50-12-K-PG	PVDF Kynar	Tube x Tube	3/4 x 3/4	5/Pack
J MALE RUN TEES					
1082969701	75-4-4-P-PG	Polypropylene	Tube x Tube x NPT(M)	1/4 x 1/4 x 1/4	10/Pack
1082969702	75-6-4-P-PG	Polypropylene	Tube x Tube x NPT(M)	3/8 x 3/8 x 1/4	10/Pack
1082969703	75-6-6-P-PG	Polypropylene	Tube x Tube x NPT(M)	3/8 x 3/8 x 3/8	10/Pack
1082969704	75-8-6-P-PG	Polypropylene	Tube x Tube x NPT(M)	1/2 x 1/2 x 3/8	10/Pack
1082969705	75-8-8-P-PG	Polypropylene	Tube x Tube x NPT(M)	1/2 x 1/2 x 1/2	10/Pack
108296A501	75-4-4-K-PG	PVDF Kynar	Tube x Tube x NPT(M)	1/4 x 1/4 x 1/4	10/Pack
108296A502	75-6-4-K-PG	PVDF Kynar	Tube x Tube x NPT(M)	3/8 x 3/8 x 1/4	10/Pack
108296A503	75-6-6-K-PG	PVDF Kynar	Tube x Tube x NPT(M)	3/8 x 3/8 x 3/8	10/Pack
108296A504	75-8-6-K-PG	PVDF Kynar	Tube x Tube x NPT(M)	1/2 x 1/2 x 3/8	10/Pack
108296A505	75-8-8-K-PG	PVDF Kynar	Tube x Tube x NPT(M)	1/2 x 1/2 x 1/2	10/Pack



HOW TO ORDER



ONLINE

supply.coreandmain.com



TELEPHONE

1-888-885-2673



EMAIL

support.supply@coreandmain.com

HOURS OF OPERATION: M-F; 6 A.M. to 7 P.M. CST



Koflo® Retractable Chemical Injection Quills

Use these Retractable Chemical Injection Quills to introduce medium to highly corrosive chemicals into a pipeline without damage to the side port or pipe wall at the point of injection. Chemical injection quills ensure that chemicals are evenly dispersed into the center of the pipeline to prevent channeling of the chemical down the pipe wall. Retractable quills allow for quick, safe and easy quill removal without the need for depressurizing the process line. The differential pressure required to open the valve, “cracking pressure”, is 5 PSI. Other ball valve materials are available upon request and can be paired with a quill material to suit your chemistry – call us at 888-885-2673 to order.



Note: The risk of damage to the solution tube when installed into flowing service increases with both solution tube length and process flow velocity. Call us at 888-885-2673 for a maximum recommended insertion length for your process.

SPECIFICATIONS

INLET CONNECTION	1/2" NPT(F)
BALL VALVE MATERIAL	Lead-Free Brass
PRESSURE RATING (PSI)	150

C&M PART #	MFG PART #	PROCESS CONNECTION	INSERTION LENGTH	QUILL MATERIAL	QUILL CHECK VALVE TYPE
105981023XPL	QR-.5B-.5HNC-6	1/2" NPT(M)	6"	Hastelloy® C-276	—
10598102B6PL	QR-.5B-.5SNC-6	1/2" NPT(M)	6"	316/L SS	—
10598102A5PL	QR-.5B-.5KNC-6	1/2" NPT(M)	6"	Kynar® PVDF	—
10598102A4PL	QR-.5B-.5PNC-6	1/2" NPT(M)	6"	PVC	—
105981013XPL	QR-.5B-.5HV-6	1/2" NPT(M)	6"	Hastelloy® C-276	Viton™
10598101B6PL	QR-.5B-.5SV-6	1/2" NPT(M)	6"	316/L SS	Viton
10598101A5PL	QR-.5B-.5KV-6	1/2" NPT(M)	6"	Kynar® PVDF	Viton
10598101A4PL	QR-.5B-.5PV-6	1/2" NPT(M)	6"	PVC	Viton
105981023XPO	QR-.75BC-.5HNC-5	3/4" CC (AWWA)	5"	Hastelloy® C-276	—
10598102B6PO	QR-.75BC-.5SNC-5	3/4" CC (AWWA)	5"	316/L SS	—
10598102A5PO	QR-.75BC-.5KNC-5	3/4" CC (AWWA)	5"	Kynar® PVDF	—
10598102A4PO	QR-.75BC-.5PNC-5	3/4" CC (AWWA)	5"	PVC	—
105981013XPO	QR-.75BC-.5HV-5	3/4" CC (AWWA)	5"	Hastelloy® C-276	Viton
10598101B6PO	QR-.75BC-.5SV-5	3/4" CC (AWWA)	5"	316/L SS	Viton
10598101A5PO	QR-.75BC-.5KV-5	3/4" CC (AWWA)	5"	Kynar® PVDF	Viton
10598101A4PO	QR-.75BC-.5PV-5	3/4" CC (AWWA)	5"	PVC	Viton
105981023XPN	QR-.75B-.5HNC-6	3/4" NPT(M)	6"	Hastelloy® C-276	—
10598102B6PN	QR-.75B-.5SNC-6	3/4" NPT(M)	6"	316/L SS	—
10598102A5PN	QR-.75B-.5KNC-6	3/4" NPT(M)	6"	Kynar® PVDF	—
10598102A4PN	QR-.75B-.5PNC-6	3/4" NPT(M)	6"	PVC	—
105981013XPN	QR-.75B-.5HV-6	3/4" NPT(M)	6"	Hastelloy® C-276	Viton
10598101B6PN	QR-.75B-.5SV-6	3/4" NPT(M)	6"	316/L SS	Viton
10598101A5PN	QR-.75B-.5KV-6	3/4" NPT(M)	6"	Kynar® PVDF	Viton
10598101A4PN	QR-.75B-.5PV-6	3/4" NPT(M)	6"	PVC	Viton
105981023XGQ	QR-1BC-.5HNC-5.5	1" CC (AWWA)	5-1/2"	Hastelloy® C-276	—
10598102B6GQ	QR-1BC-.5SNC-5.5	1" CC (AWWA)	5-1/2"	316/L SS	—
10598102A5GQ	QR-1BC-.5KNC-5.5	1" CC (AWWA)	5-1/2"	Kynar® PVDF	—
10598102A4GQ	QR-1BC-.5PNC-5.5	1" CC (AWWA)	5-1/2"	PVC	—
105981013XGQ	QR-1BC-.5HV-5.5	1" CC (AWWA)	5-1/2"	Hastelloy® C-276	Viton
10598101B6GQ	QR-1BC-.5SV-5.5	1" CC (AWWA)	5-1/2"	316/L SS	Viton
10598101A5GQ	QR-1BC-.5KV-5.5	1" CC (AWWA)	5-1/2"	Kynar® PVDF	Viton
10598101A4GQ	QR-1BC-.5PV-5.5	1" CC (AWWA)	5-1/2"	PVC	Viton
105981023XGR	QR-1B-.5HNC-6	1" NPT(M)	6"	Hastelloy® C-276	—
10598102B6GR	QR-1B-.5SNC-6	1" NPT(M)	6"	316/L SS	—
10598102A5GR	QR-1B-.5KNC-6	1" NPT(M)	6"	Kynar® PVDF	—
10598102A4GR	QR-1B-.5PNC-6	1" NPT(M)	6"	PVC	—
105981013XGR	QR-1B-.5HV-6	1" NPT(M)	6"	Hastelloy® C-276	Viton
10598101B6GR	QR-1B-.5SV-6	1" NPT(M)	6"	316/L SS	Viton
10598101A5GR	QR-1B-.5KV-6	1" NPT(M)	6"	Kynar® PVDF	Viton
10598101A4GR	QR-1B-.5PV-6	1" NPT(M)	6"	PVC	Viton

SPEARS TRUE UNION BALL VALVES

See **page 472** for details on
Spears True Union 2000
PVC Industrial Vented/Bleach
Ball Valves and more!

Koflo® Fixed Chemical Injection Quills

Introduce medium to highly corrosive chemicals into a pipeline without damage to the side port or pipe wall at the point of injection using these Chemical Injection Quills. Injection quills ensure that chemicals are evenly dispersed into the center of the pipeline to prevent channeling of the chemical down the pipe wall.



These chemical injection quills feature precision-engineered components, including machined housings that ensure reliable and even chemical dispersion within the center of the pipeline. Each unit comes complete with an integral removable spring-loaded ball check to prevent flow of the injected chemical into the main flow when the system is shut down.

Select from chemical-resistant plastic or alloy quill (body and stinger) material. Quills come with a Viton® (FKM) check valve O-ring, but EPDM and Kalrez options are available upon request. The required cracking pressure for all quills is 5 psi. Cracking pressure refers to the differential pressure between the injection and process lines required to open the integrated check valve.

Koflo® Chemical Injection Quill Repair Parts

Chemical Injection Quill Rebuild Kits are necessary to replace or add an internal check valve on your injection quill. Rebuild kits include Hastelloy® spring, retention washer, seat plug and ceramic check ball. Check your injection quill's material and inlet size to determine which kit you need. Rebuild kits do not include O-rings.

Use O-Ring kits for full injection quill rebuilds or replacing materials for better chemical compatibility. Both rebuild kits and O-ring kits are suitable for use on fixed and retractable chemical injection quills.

REBUILD KIT ORDERING TABLE

C&M PART #	MFG PART #	INLET SIZE	QUILL MATERIAL
106054	QRK-H-.5	1/2"	Hastelloy® C-276
106051	QRK-S-.5	1/2"	316/L SS
106048	QRK-K-.5	1/2"	Kynar® (PVDF)
106045	QRK-P-.5	1/2"	PVC
106055	QRK-H-.75	3/4"	Hastelloy C-276
106052	QRK-S-.75	3/4"	316/L SS
106049	QRK-K-.75	3/4"	Kynar (PVDF)
106046	QRK-P-.75	3/4"	PVC
106056	QRK-H-1	1"	Hastelloy C-276
106053	QRK-S-1	1"	316/L SS
106050	QRK-K-1	1"	Kynar (PVDF)
106047	QRK-P-1	1"	PVC

CERTIFICATIONS

- NSF/ANSI 61, NSF 372 Certified

C&M PART #	MFG PART #	CONNECTION NPT(F) x NPT(M)	QUILL MATERIAL	STINGER LENGTH	MAX PRESSURE (PSIG)*	MAX TEMP. (°F)
10602187A4PL	QP-.5-3-V	1/2"	PVC	3"	150	140
106021F9A4PL	QP-.5-5-V	1/2"	PVC	5"	150	140
106021875XPL	QK-.5-3-V	1/2"	PVDF	3"	150	280
106021F95XPL	QK-.5-5-V	1/2"	PVDF	5"	150	280
1060218704PL	QS-.5-3-V	1/2"	316/L SS	3"	3000	500
106021F904PL	QS-.5-5-V	1/2"	316/L SS	5"	3000	500
106021873XPL	QH-.5-3-V	1/2"	Hastelloy®	3"	3000	500
106021F93XPL	QH-.5-5-V	1/2"	Hastelloy	5"	3000	500
106021C1A4PN	QP-.75-4-V	3/4"	PVC	4"	150	140
106021I2A4PN	QP-.75-6-V	3/4"	PVC	6"	150	140
106021C15XPN	QK-.75-4-V	3/4"	PVDF	4"	150	280
106021I25XPN	QK-.75-6-V	3/4"	PVDF	6"	150	280
106021C104PN	QS-.75-4-V	3/4"	316/L SS	4"	3000	500
106021I204PN	QS-.75-6-V	3/4"	316/L SS	6"	3000	500
106021I23XPN	QH-.75-4-V	3/4"	Hastelloy	4"	3000	500
106021I23XPN	QH-.75-6-V	3/4"	Hastelloy	6"	3000	500
106021F9A4GR	QP-1.0-5-V	1"	PVC	5"	150	140
106021L1A4GR	QP-1.0-8-V	1"	PVC	8"	150	140
106021F95XGR	QK-1.0-5-V	1"	PVDF	5"	150	280
106021L15XGR	QK-1.0-8-V	1"	PVDF	8"	150	280
106021F904GR	QS-1.0-5-V	1"	316/L SS	5"	3000	500
106021L104GR	QS-1.0-8-V	1"	316/L SS	8"	3000	500
106021F93XGR	QH-1.0-5-V	1"	Hastelloy	5"	3000	500
106021L13XGR	QH-1.0-8-V	1"	Hastelloy	8"	3000	500

*Maximum pressures are listed at ambient temperature. Maximum temperatures assume ambient pressure. For applications with elevated temperature and pressure, call Core & Main at 888-885-2673.



O-RING KIT ORDERING TABLE

C&M PART #	MFG PART #	INLET SIZE	O-RING MATERIAL	QUANTITY
106060	QOK-.5-E-10	1/2"	EPDM	10
106057	QOK-.5-V-10	1/2"	Viton® (FKM)	10
106063	QOK-.5-K-1	1/2"	Kalrez® 6375	1
106061	QOK-.75-E-5	3/4"	EPDM	5
106058	QOK-.75-V-5	3/4"	Viton (FKM)	5
106064	QOK-.75-K-1	3/4"	Kalrez 6375	1
106062	QOK-1-E-5	1"	EPDM	5
106059	QOK-1-V-5	1"	Viton (FKM)	5
106065	QOK-1-K-1	1"	Kalrez 6375	1

Koflo® PVC Calibration Columns



Ensure the accuracy of your pump flow rate with these Pump Calibration Columns (also known as calibration cylinders). All columns feature top-aligned precisely graduated mL/min and GPH scales for a single, one-minute test. These dual-scale metered graduations provide accurate measurements in your preferred flow units. High-contrast blue lettering enhances readability in all light conditions, and all scales have a protective lamination layer to protect against chemical attack. PVC calibration columns are an economical choice for noncorrosive or mild chemicals.

C&M PART #	MFG PART #	FLOW RANGE (mL/min)	FLOW RANGE (GPH)	INCREMENTS (mL Gal)	TUBE OD	COLUMN HEIGHT	END CONNECTIONS NPT(F)
FIXED CAP							
105939DGOG4R	100 ML	0 to 100	0 to 1.5	1 0.020	1.315"	12-1/2"	1/2"
105939EPC14R	250 ML	0 to 250	0 to 4	2 0.050	1.660"	16-1/4"	1/2"
105939FDL13V	500 ML	0 to 500	0 to 8	5 0.050	2.375"	16"	3/4"
105939FQS83V	1000 ML	0 to 1000	0 to 16	5 0.125	2.375"	25"	3/4"
105939FWZ72A	2000 ML	0 to 2000	0 to 32	10 0.250	3.500"	24"	1"
105939GBBV2A	4000 ML	0 to 4000	0 to 64	20 0.250	4.000"	34"	1"
105939NNNM2C	10000 ML	0 to 10,000	0 to 160	100 1.000	6.625"	27"	2"
105939NOES2C	20000 ML	0 to 20,000	0 to 320	100 1.000	6.625"	46"	2"
TOP SLIP CAP							
105947DGOG4R	100 ML-SC	0 to 100	0 to 1.5	1 0.020	1.315"	12-1/2"	1/2"
105947EPC14R	250 ML-SC	0 to 250	0 to 4	2 0.050	1.660"	16-1/4"	1/2"
105947FDL13V	500 ML-SC	0 to 500	0 to 8	5 0.050	2.375"	16"	3/4"
105947FQS83V	1000 ML-SC	0 to 1000	0 to 16	5 0.125	2.375"	25"	3/4"
105947FWZ72A	2000 ML-SC	0 to 2000	0 to 32	10 0.250	3.500"	24"	1"
105947GBBV2A	4000 ML-SC	0 to 4000	0 to 64	20 0.250	4.000"	34"	1"
105947NNNM2C	10000 ML-SC	0 to 10,000	0 to 160	100 1.000	6.625"	27"	2"
105947NOES2C	20000 ML-SC	0 to 20,000	0 to 320	100 1.000	6.625"	46"	2"

Koflo® Flanged Static Inline Mixers

Connect these motionless Flanged Static Inline Mixers to continuously blend the fluids within a pipeline. With no moving parts, static mixers utilize the energy of the flow stream to generate consistent, cost-effective and reliable mixing. Mixers are edge-sealed using a high-strength PVC for durability. The patented Koflo blade elements provide efficient mixing ability for turbulent flow applications with minimal pressure loss.



FEATURES & BENEFITS

- Built to last using industrial grade materials
- Low-cost alternative to tank mixers—there is no running cost associated to use these mixers
- Low energy requirements due to motionless design
- Lower chemical use thanks to efficient blending

SPECIFICATIONS

MATERIAL	Schedule 80 PVC
CONNECTION TYPE	150-lb Van Stone Flange
NUMBER OF ELEMENTS*	4
EXTERIOR / TOPCOAT	Koflo Blue UV-Resistant w/ Imron® 3.5 HG™ / Polyurethane
MAXIMUM WORKING PRESSURE (PSI)	150

*Koflo flanged static inline mixers are designed for higher flow rates therefore they use 4 elements instead of 6 to minimize pressure loss

CERTIFICATIONS

- NSF/ANSI 61 Certified, NSF 372 Certified

C&M PART #	MFG PART #	PIPE SIZE	LENGTH	CHEMICAL INJECTION PORT	FLOW RANGE (GPM)	PRESSURE LOSS (PSI)
A STANDARD MIXERS						
105969J630	1-80-4-4-9	1"	7"	-	5 to 15	0.75 to 6.7
105969N840	1.5-80-4-4-9	1-1/2"	10"	-	15 to 35	1.1 to 6.2
105969Q350	2-80-4-4-9	2"	12"	-	25 to 60	1.1 to 6.2
105969U587	3-80-4-4-9	3"	18"	-	60 to 150	0.9 to 5.7
105969W5C1	4-80-4-4-9	4"	23"	-	90 to 250	0.7 to 5.3
105969Z912	6-80-4-4-9	6"	33"	-	175 to 500	0.6 to 4.8
B MIXERS WITH INJECTION PORT						
105969Q330	1-80-4-4-9.1	1"	12"	0.5" NPT(M)	5 to 15	0.75 to 6.7
105969S840	1.5-80-4-4-9.1	1-1/2"	16"	0.5" NPT(M)	15 to 35	1.1 to 6.2
105969U950	2-80-4-4-9.1	2"	19"	0.75" NPT(M)	25 to 60	1.1 to 6.2
105969Y287	3-80-4-4-9.1	3"	27"	0.75" NPT(M)	60 to 150	0.9 to 5.7
105969Z7C1	4-80-4-4-9.1	4"	32"	0.75" NPT(M)	90 to 250	0.7 to 5.3
105969AN12	6-80-4-4-9.1	6"	41"	1" NPT(M)	175 to 500	0.6 to 4.8

Koflo® Clear PVC Static Mixers

The Clear PVC Static Mixers allow for visual inspection of the mixing process. With no moving parts, static mixers utilize the energy of the flow stream to generate consistent, cost-effective and reliable mixing. All PVC static mixers are edge sealed to the inside of the housing for the twofold benefit of improved mixing efficiency and increased structural rigidity. Select static mixers in 6 element or 12 element configurations.

SPECIFICATIONS

HOUSING	Schedule 40 Clear PVC
ELEMENTS	Koflo Blade™ Style PVC
END CONNECTIONS	NPT(M)

CERTIFICATIONS

- NSF/ANSI 61



C&M PART #	MFG PART #	PIPE SIZE/ CONNECTION NPT(M)	# OF ELEMENTS	LENGTH	MAX WORKING PRESSURE (PSI @ 75°F)	TYPICAL FLOW (GPM)	PRESSURE LOSS (PSI)
105955OL4S	3/8-40C-4-6-2	3/8"	6	6-1/2"	310	0.4 to 3	0.25 to 11.25
105955P14S	3/8-40C-4-12-2	3/8"	12	11"	310	0.4 to 3	0.50 to 22.5
105955J64R	1/2-40C-4-6-2	1/2"	6	7"	300	0.65 to 5	0.25 to 10
105955Q34R	1/2-40C-4-12-2	1/2"	12	12"	300	0.65 to 5	0.50 to 20
105955M53V	3/4-40C-4-6-2	3/4"	6	9"	240	1.5 to 12	0.25 to 11
105955S23V	3/4-40C-4-12-2	3/4"	12	15"	240	1.5 to 12	0.50 to 22
105955P12A	1-40C-4-6-2	1"	6	11"	220	2.5 to 16	0.30 to 11.75
105955U52A	1-40C-4-12-2	1"	12	18"	220	2.5 to 16	0.60 to 23.5
105955R6VY	1.25-40C-4-6-2	1-1/4"	6	14"	180	4 to 32	0.25 to 13.5
105955X2VY	1.25-40C-4-12-2	1-1/4"	12	25"	180	4 to 32	0.50 to 27
105955S22B	1.5-40C-4-6-2	1-1/2"	6	15"	170	6 to 40	0.25 to 12.25
105955Y72B	1.5-40C-4-12-2	1-1/2"	12	28"	170	6 to 40	0.50 to 24.5
105955U92C	2-40C-4-6-2	2"	6	19"	140	9 to 60	0.25 to 9.25
105955AC2C	2-40C-4-12-2	2"	12	35"	140	9 to 60	0.50 to 18.5

Griffco Diaphragm Back Pressure Valves

These Back Pressure Valves enhance the performance of chemical feed systems by applying a continuous back pressure to the chemical feed pump, while also acting as an anti-syphon valve. Diaphragm back pressure valves apply positive discharge pressure to a metering pump system preventing siphoning and eliminating varying dosage rates caused by fluctuating downstream pressure. The diaphragm is held against the valve seat by an internal spring. When the preset pressure is exceeded, the diaphragm is forced up and chemical flows through the valve to the injection point.



All valves come preset at 50 psi, however they are field adjustable from 10 to 150 psi via the adjustment screw. Robust construction ensures reliability in the rigorous service of municipal and industrial applications. Easily spot check system pressure with the integrated pressure gauge option.

FEATURES & BENEFITS

- Molded Noryl top with integral hardware locking
- Molded PTFE/EPDM diaphragm
- Four optional pressure ratings (springs)
- Tamper-resistant adjustment screw

SPECIFICATIONS

PRESSURE ADJUSTMENT (PSI)	10 to 150
VALVE BODY MATERIAL	PVC

C&M PART #	MFG PART #	INTEGRATED PRESSURE GAUGE (Y/N)	CONNECTION	FLOW RATE @ 150 PSI (PULSATING GPH)	FLOW RATE @ 150 PSI (CONTINUOUS GPM)	MAX OPERATING PRESSURE @ 70°F (PSI)
M-SERIES BACK PRESSURE VALVES						
105782240A	BPM025-P	N	1/4" NPT(F)	100	5	375
10578224PJ	BPM038-P	N	3/8" NPT(F)	200	10	375
105782240E	BPM050-P	N	1/2" NPT(F)	300	15	375
105789240A	BPIM025-P	Y	1/4" NPT(F)	100	5	375
10578924PJ	BPIM038-P	Y	3/8" NPT(F)	200	10	375
G-SERIES BACK PRESSURE VALVES						
105782250F	BPG075-P	N	3/4" NPT(F)	367	19.2	375
1057822530	BPG100-P	N	1" NPT(F)	462	24.2	375
1057822440	BPG155-P	N	1-1/2" NPT(F)	1388	72.7	375
1057822450	BPG200-P	N	2" NPT(F)	1533	80.3	375
105789240E	BPIG050-P	Y	1/2" NPT(F)	320	16.7	375
105789250F	BPIG075-P	Y	3/4" NPT(F)	367	19.2	375
1057892530	BPIG100-P	Y	1" NPT(F)	462	24.2	375
UNIBODY SERIES BACK PRESSURE VALVES						
105794240E	BPU050-P	N	1/2" Union Socket	260	15	250
105794240F	BPU075-P	N	3/4" Union Socket	300	19	250
1057942430	BPU100-P	N	1" Union Socket	500	26	250

Note: Install back pressure valves as close to the injection point as possible to prevent chemical line drainage. All chemical system equipment such as pulsation dampeners and pressure gauges should be between the pump and back pressure valve.



Griffco Pressure Relief Valves



Protect chemical feed systems from over pressure damage caused by defective equipment or a blockage in the chemical feed line using Griffco Pressure Relief Valves. When the preset pressure is exceeded, the diaphragm which is held against the valve seat by an internal spring, is forced up and the chemical flows out the relief port, back to the chemical tank or to the suction side of the pump. Robust construction ensures reliability in the rigorous service of municipal and industrial applications.

The valves are preset at 50 psi, however they are field adjustable from 10 to 150 psi via the adjustment screw. Set relief valve approximately 15 psi higher than the system pressure. Robust construction ensures reliability in the rigorous service of municipal and industrial applications. Order pressure relief valves with optional pressure switch to interface with your control system. Pressure switches come standard as zinc plated steel and normally open. Pressure switch is installed in an instrument isolator at the bottom of the valve and is adjustable from 15 to 60 psi. Units with pressure switch ranges of 40 to 150 psi, 316L SS switch body material and normally closed options are all also available, call us at 888-885-2673 to order.

FEATURES & BENEFITS

- Molded Noryl top with integral hardware locking
- 4 optional pressure ratings (springs)
- Tamper-resistant adjustment screw
- Molded PTFE/EPDM diaphragm

SPECIFICATIONS

PRESSURE ADJUSTMENT (PSI)	10 to 150
VALVE BODY MATERIAL	PVC
MAX OPERATING PRESSURE @ 70°F (PSI)	375

C&M PART #	MFG PART #	PRESSURE SWITCH (Y/N)	CONNECTIONS	FLOW RATE @ 150 PSI (PULSATING GPH)	FLOW RATE @ 150 PSI (CONTINUOUS GPH)
M-SERIES RELIEF VALVES					
105797240A	PRM025-P	N	1/4" NPT(F)	100.0	5.0
10579724PJ	PRM038-P	N	3/8" NPT(F)	200.0	10.0
105797240E	PRM050-P	N	1/2" NPT(F)	300.0	15.0
105809240E	PRM050-PU	N	1/2" Union Socket	300.0	15.0
105804240A	PRSM025-P	Y	1/4" NPT(F)	100.0	5.0
10580424PJ	PRSM038-P	Y	3/8" NPT(F)	200.0	10.0
105804240E	PRSM050-P	Y	1/2" NPT(F)	300.0	15.0
G-SERIES RELIEF VALVES					
105797250F	PRG075-P	N	3/4" NPT(F)	367.0	19.2
105809240F	PRG075-PU	N	3/4" Union Socket	367.0	19.2
1057972530	PRG100-P	N	1" NPT(F)	462.0	24.2
1058092430	PRG100-PU	N	1" Union Socket	462.0	24.2
1057972440	PRG155-P	N	1-1/2" NPT(F)	1388.0	72.7
1057972450	PRG200-P	N	2" NPT(F)	1533.0	80.3
105804250F	PRSG075-P	Y	3/4" NPT(F)	367.0	19.2
1058042530	PRSG100-P	Y	1" NPT(F)	462.0	24.2

Note: Install relief valves as close to the pump as possible, without any valves or accessories between the relief valve and the pump.

AMT® Hand Diaphragm Pump

AMT Hand Diaphragm Pump offers a simple way to dispense debris-free liquids and chemicals. This pump is an ideal solution in transferring liquids in marine, sanitation, home and industrial applications.



C&M PART #	MFG PART #	DESCRIPTION
105832	HP01-99	Hand Diaphragm Pump

SPECIFICATIONS

CONSTRUCTION	Derlin Plastic
HANDLE MATERIAL	Rugged Aluminum
HANDLE	Adjustable (12 Orientations)
DIAPHRAGM AND FLAPPER	Buna-N
MAX TEMPERATURE	130°F (54°C)
DISCHARGE*	1" / 1-1/2" Smooth Hose
MAX LIFT (ft)	12
MAX DISCHARGE HEAD (ft)	30
FLOW RATE	12 GPM @ 90 Strokes/min
WEIGHT (lbs)	3
MAX PRESSURE (PSI)	2

*Discharge port kit for both 1" and 1-1/2" connections are included.

AMT® Rotary Drum Pumps

Easily dispense liquids from drums with the AMT Rotary Drum Pumps. Pumps are self-priming and designed to transfer debris-free liquids. Use the Ryton® drum pump for transferring aggressive chemicals; polypropylene pump is ideal for dispensing many organic acids and alcohols. All units include discharge spout, bung adapter and suction tube assembly for a quick and simple connection.



SPECIFICATIONS

C&M PART #	105830	105831
CONSTRUCTION	Ryton with Ryton Rotor and Vanes	Polypropylene with Ryton Rotor and Vanes
SEAL	Teflon®	
MAX TEMPERATURE	180° F (82° C)	130°F (54°C)
FLOW RATE	6 GPM @ 70 RPM (11 oz/Stroke)	
WEIGHT (lbs)	8	12

INCLUDES

1" OD Ryton discharge spout assembly, 1" ID x 45" L Ryton suction tube assembly and 2" bung adapter

C&M PART #	MFG PART #	DESCRIPTION
105830	4942-99	Rotary Drum Pump
105831	4946-99	Rotary Drum Pump

FTI EFV Drum Pump Kits

Designed for use as a medium volume transfer pump with water treatment chemicals like sodium hypochlorite, Finish Thompson EFV-Series Drum/Barrel Pumps are an economical and lightweight choice for light-duty fluid transfer. These pumps reduce risk, as they are designed to withstand harsh chemicals and keep them safely contained during transfers, effectively mitigating operator and company risk. They are compact and easily portable for various tasks throughout a facility, making them an ideal replacement for hand pumps. Kits include everything in one convenient carton to quickly transfer liquids from a drum. Choose from electric motor or air-operated kits.



FEATURES & BENEFITS

- Takes up with minimal footprint to conserve space or for use in smaller settings
- Easily transfer high volumes of fluids quickly and effectively to improve productivity
- Durable pumps offer longevity and low maintenance throughout to save you money
- Built-in strainer protects pump

INCLUDES

Motor, drum pump tube, PVDF nozzle, wall mounting bracket and 6-ft ultra-high molecular weight polyethylene hose

SPECIFICATIONS

MOTOR TYPE	115 VAC MOTOR	12 VDC MOTOR	AIR MOTOR
PUMP TUBE MATERIAL	Pure Polypropylene/PVDF		
PUMP TUBE DIAMETER	1-5/16"		
PUMP DISCHARGE HOSE	5-ft, ultra-high molecular weight polyethylene hose		
MAX FLOW RATE (GPM)	17	14	15
MAX DISCHARGE HEAD (ft)	20	13	17
MAX VISCOSITY (cP)	300	100	300
MAX SPECIFIC GRAVITY	1.6		
DISCHARGE SIZE	3/4" Hose Barb		
HOSE SIZE	3/4"		
MOTOR POWER CORD LENGTH (ft)	12	—	—
MOTOR RATING	ODP/Splashproof, IP24		

Note: All testing performed with water at 68°F, in a full container. Actual performance may vary by +/-10%. Actual performance will decrease with increased fluid viscosity and specific gravity.

CERTIFICATIONS

- 115 VAC Electric motor, QPS; 12 VDC motor, CE

C&M PART #	MFG PART #	TUBE LENGTH	MOTOR TYPE
401276	111621	40"	Two-Speed, 115 VAC, Electric, ODP/IP24
401277	111623	40"	Two-Speed, 12 VDC, Lithium-ion Battery, ODP w/ USA Plug Charger
401278	111625	40"	Two-Speed, 12 VDC, Lithium-ion Battery, ODP w/ 12 V Car Adapter
401279	111626	40"	Variable Speed, Air Motor, Requires 27 cfm @ 40 PSI

REPLACEMENT PARTS & ACCESSORIES

C&M PART #	MFG PART #	REPLACEMENT DRUM PUMP TUBES
401287	DEFV003	EFV40 Drum Pump Only, 40" Tube Length, Pure Polypropylene/PVDF
401288	DEFV010	EFV54 Drum Pump Only, 54" Tube Length, Pure Polypropylene/PVDF



FTI SFV Drum Pump Kits

High-volume transfer, high-performance Finish Thompson SFV-Series Drum/Barrel Pumps are designed for use with water treatment chemicals (alum, ferric chloride, hydrochloric acid, fluoride, permanganates, sodium bisulfate, sodium hypochlorite, polymers). These pumps reduce risk, as they are designed to withstand harsh chemicals and keep them safely contained during transfers, effectively mitigating operator and company risk. They are compact and easily portable for various tasks throughout a facility, making them an ideal replacement for hand pumps. Kits include everything in one convenient carton to quickly transfer liquids from a drum. Choose from electric motor or air-operated kits.

FEATURES & BENEFITS

- Takes up with minimal footprint to conserve space or for use in smaller settings
- Easily transfer high volumes of fluids quickly and effectively to improve productivity
- Durable pumps offer longevity and low maintenance throughout to save you money
- Built-in strainer protects pump
- Electric motor kit versions feature variable-speed and solid state overload protection

INCLUDES

Motor, drum pump tube, PVDF nozzle, wall mounting bracket, bung adapter and 6-ft ultra-high molecular weight polyethylene hose

SPECIFICATIONS

MOTOR TYPE	ELECTRIC MOTOR	AIR MOTOR
PUMP TUBE MATERIAL	Pure polypropylene /PVDF tube with FKM elastomers	
PUMP TUBE DIAMETER (in)	1.6	
PUMP DISCHARGE HOSE	6-ft, ultra-high molecular weight polyethylene hose	
MAX FLOW RATE (GPM)	37	31
MAX DISCHARGE HEAD (ft)	50	32
MAX VISCOSITY (cP)	1000	1200
MAX SPECIFIC GRAVITY	1.84	2.0
DISCHARGE SIZE	1" Hose Barb	
HOSE SIZE	1"	
POWER CORD LENGTH (ft)	12, with plug	—

Note: All testing performed with water at 68°F, in a full container. Actual performance may vary by +/-10%. Actual performance will decrease with increased fluid viscosity and specific gravity.



CERTIFICATIONS

- Electric Motor, QPS; Air Motor, CE

C&M PART #	MFG PART #	TUBE LENGTH	MOTOR TYPE
401280	111666	40"	Variable Speed, 115 VAC, TEFC/IP55
401281	111667	48"	Variable Speed, 115 VAC, TEFC/IP55
401282	111670	40"	Variable Speed Air Motor, Requires 80 to 100 PSI @15 to 32 cfm
401283	111671	48"	Variable Speed Air Motor, Requires 80 to 100 PSI @15 to 32 cfm

REPLACEMENT PARTS & ACCESSORIES

C&M PART #	MFG PART #	REPLACEMENT DRUM PUMP TUBES
401299	DSFV003	40" Tube Length, Pure Polypropylene, PVDF
401300	DSFV005	48" Tube Length, Pure Polypropylene, PVDF
401301	DSFV009	60" Tube Length, Pure Polypropylene, PVDF
401302	DSFVV003	40" Tube Length, Pure PVDF
401303	DSFVV005	48" Tube Length, Pure PVDF
401304	DSFVV009	60" Tube Length, Pure PVDF

UltraTech Low-Profile Ultra-Spill Deck® Pallets

Use these Low-Profile Ultra-Spill Deck Pallets to easily move drums on and off the spill pallets. Bulkhead fittings "lock" the modules together as well as allow spilled liquid to flow from one module to the next. Low-profile pallets keep the top of the drums at a lower level, minimizing potential risk of splashes or spilled liquid right at eye level. Order optional loading ramp for added drum handling safety and convenience (not for use with one-drum model or short side of two-drum model).



C&M PART #	MFG PART #	DRUM QUANTITY	DIMENSIONS (L x W x H)	GRATING SURFACE	WEIGHT CAPACITY UDL (lbs)	CONTAINMENT CAPACITY (GAL)	WEIGHT (lbs)
10924903	1321	1	25.9" x 25.9" x 5.8"	24" x 24"	1500	11	23
10924904	1086	2	52" x 25.9" x 5.8"	48" x 24"	3000	22	40
10924906	1072	4	52" x 52" x 5.8"	48" x 48"	6000	44	70

FEATURES & BENEFITS

- All-polyethylene constructions meets a wide range of chemical compatibility needs
- Applications include hazardous waste collection, storage of virgin chemicals, drum dispensing and battery storage
- 5-year warranty

REPLACEMENT PARTS & ACCESSORIES

C&M PART #	MFG PART #	DESCRIPTION	DIMENSIONS (L x W x H)	WEIGHT CAPACITY UDL (lbs)	WEIGHT (lbs)
109258	1089	Loading Ramp	32" x 24" x 5.8"	600	17

UltraTech Ultra-Spill Pallet® Containment Units

Protect against chemical spills or leaks using Ultra-Spill Pallet Containment Units. The sturdy 100% polyethylene (LLDPE) construction is compatible with a broad range of chemicals and supports heavy loads. The nestable model (109266) perfectly nests together maximizing valuable shipping and storage space. The low-rise walls allow easier accessibility for pouring. An optional ramp is available for use with four-drum models for easier loading, unloading and drum handling.

All non-nestable models (1010, 1011 and 1000) feature the “Cross of Life”, a cross of polyethylene plastic molded across the top of the spill pallet that connects the four sidewalls together. The more weight that is placed on the top of the grates, the more weight that is applied to the cross of life which in turn helps pull the sidewalls in, providing a great protection for the sidewalls.

FEATURES & BENEFITS

- Complies with SPCC and EPA spill containment requirements
- Bright safety yellow sidewalls are translucent, offering convenient visual leak detection
- 5-year warranty



C&M PART #	MFG PART #	DRUM QUANTITY	DRAIN (Y/N)	DIMENSIONS (L x W x H)	GRATING SURFACE	WEIGHT CAPACITY UDL (lb)	CONTAINMENT CAPACITY (GAL)	WEIGHT (lb)
1092630204	1010	2	N	53" x 29" x 16.5"	48" x 24"	3000	66	63
1092630104	1011	2	Y	53" x 29" x 16.5"	48" x 24"	3000	66	63
1092630206	1000	4	N	53" x 53" x 11.8"	48" x 48"	6000	66	90
109266	1230	4	N	51" x 51" x 10"	48" x 48"	6000	66	80

REPLACEMENT PARTS & ACCESSORIES

C&M PART #	MFG PART #	DESCRIPTION	DIMENSIONS (L x W x H)	WEIGHT CAPACITY UDL (lbs)	WEIGHT (lbs)
109267*	0678	Ramp for Four-Drum Models	68.5" x 28.5" x 12"	700	73

*For use with Standard and Economy model spill pallets

UltraTech Economy Ultra-Spill Pallet® Containment Units

The Economy Ultra-Spill Pallet Containment Units were designed to help meet spill containment regulations without breaking the bank. These units are made recycled resin, making them cost effective to manufacture. Store 55-gallon drums or other containers of hazardous material on the containment unit. A 66-gallon sump captures any incidental leaks or drips, as well as any spills. The all-polyethylene 2 ft x 4 ft grating keeps drums above any spills and is removed for a quick clean-up. Transport all models with a pallet jack or forklift. An optional ramp is available for use with four-drum models for easier loading, unloading and drum handling. The drain option allows any spilled contents to be easily removed.

All economy models feature the “Cross of Life”, a cross of polyethylene plastic molded across the top of the spill pallet that connects the four sidewalls together. The more weight that is placed on the top of the grates, the more weight that is applied to the cross of life which in turn helps pull the sidewalls in, providing a great protection for the sidewalls.

FEATURES & BENEFITS

- Applications for the all-polyethylene units include satellite waste collection and storage of virgin chemicals
- Black color helps hide dirt and grime
- Removable grating makes clean-up quick and easy
- 5-year warranty



C&M PART #	MFG PART #	DRUM QUANTITY	DRAIN (Y/N)	DIMENSIONS (L x W x H)	GRATING SURFACE	WEIGHT CAPACITY UDL (lbs)	CONTAINMENT CAPACITY (GAL)	WEIGHT (lbs)
1092590204	2504	2	N	53" x 29" x 16.5"	48" x 24"	1200	66	63
1092590104	2505	2	Y	53" x 29" x 16.5"	48" x 24"	1200	66	63
1092590206	1112	4	N	53" x 53" x 11.8"	48" x 48"	3000	66	85
1092590106	1113	4	Y	53" x 53" x 11.8"	48" x 48"	3000	66	85

REPLACEMENT PARTS & ACCESSORIES

C&M PART #	MFG PART #	DESCRIPTION	DIMENSIONS (L x W x H)	WEIGHT CAPACITY UDL (lbs)	WEIGHT (lbs)
109267	0678	Ramp for Four-Drum Models	68.5" x 28.5" x 12"	700	73

UltraTech Ultra-IBC Spill Pallet® Containment Units

The Ultra-IBC Spill Pallet Containment Unit is designed to prevent, control and mitigate accidental spills, leaks and the unintentional release of hazardous substances. The high weight capacity of 16,000 lbs allows safe double stacking of intermediate bulk containers (IBCs), saving you valuable floor. The large, 400-gallon spill containment capacity keeps you in compliance with EPA and SPCC spill containment regulations and EPA Container Storage Regulation 40 CFR 264.175. The durable all-polyethylene construction with no metal parts means no risk of rust and corrosion.



FEATURES & BENEFITS

- 100% polyethylene (LLDPE) construction provides excellent chemical resistance
- All grating and inner components are easily removed for quick and easy clean-up
- Large 400-gallon sump capacity
- Complies with SPCC and EPA spill containment requirements

C&M PART #	MFG PART #	DRAIN (Y/N)	DIMENSIONS (L x W x H)	GRATING SURFACE	WEIGHT CAPACITY UDL (lbs)	CONTAINMENT CAPACITY (GAL)	WEIGHT (lbs)
10926802	1057	N	58.8" x 58.8" x 33"	52" x 52"	16,000	400	444
10926801	1058	Y	58.8" x 58.8" x 33"	52" x 52"	16,000	400	444

UltraTech Ultra-IBC Berm® Spill Pallets



Combining the functionality of a rugged polyethylene (LLDPE) spill pallet with the containment capacity of a spill berm, the Ultra-IBC Spill Berm is a great economical alternative to traditional intermediate bulk container (IBC) spill pallets. With an 85-gallon inner pallet and 400-gallon outer berm, this system can handle catastrophic spills that traditional IBC spill pallets cannot. Set up takes minutes and requires no tools or forklifts.

FEATURES & BENEFITS

- IBCs can be loaded/unloaded without breaking down berm sidewalls
- Polyethylene (pallet) and 22 oz PVC (berm) construction stands up to rigors found onsite
- Provides excellent chemical compatibility

C&M PART #	MFG PART #	DIMENSIONS (L x W x H)	WEIGHT CAPACITY UDL (lbs)	CONTAINMENT CAPACITY (GAL)	WEIGHT (lbs)
109233	0816	72" x 72" x 18"	6500	400	136

UltraTech Steel Ultra-IBC Spill Pallet® Containment Unit



Safely store intermediate bulk containers (IBCs) and other containers storing flammable liquids on Steel Spill Pallet Containment Unit. This heavy-duty, 14-gauge galvanized steel construction provides years of service and excellent chemical resistance. Unlike most IBC spill containment products which are made from polyethylene, this steel unit will not melt or deform from extreme heat or fire. Removable, two-piece grating provides for easy clean-up and maintenance.

FEATURES & BENEFITS

- Excellent for storage of chemicals, hazardous materials and flammable liquids
- Heavy duty, 14 gauge galvanized steel construction offers excellent durability
- 100% leak free tested
- Forkliftable from all sides for easy handling and transport
- Meets SPCC and EPA Container Storage Regulation 40 CFR 264.175 Spill Containment Regulations

C&M PART #	MFG PART #	DIMENSIONS (L x W x H)	WEIGHT CAPACITY UDL (lbs)	CONTAINMENT CAPACITY (GAL)	WEIGHT (lbs)
109270	1184	57.6" x 56.9" x 34.7"	5650	370	337.5

Ultra-Hard Top Spill Pallet® Drum Storage Units

Safely and conveniently store 55-gallon drums inside these spill containment storage units. Simply place your drums inside of the unit with your drum handling equipment, close the doors and you are done. Your drums are protected from the elements and unauthorized access (the unit can be locked) and your property and employees are protected from spills or leaks. The roll-top doors provide complete and easy access to the inside spill containment area. Load one-drum model using a forklift and/or drum handling equipment; the two- and four-drum models feature swing outdoors below for easy loading and unloading.

The P4 Plus (109275) model features the “Cross of Life”, a cross of polyethylene plastic molded across the top of the spill pallet that connects the four sidewalls together. The more weight that is placed on the top of the grates, the more weight that is applied to the cross of life which in turn helps pull the sidewalls in, providing a great protection for the sidewalls.



FEATURES & BENEFITS

- Headspace easily accommodates rotary drum pumps and large conical funnels
- Low-profile containment pallet positions drum-top funnels at a safe, convenient level to pour hazardous wastes
- 100% polyethylene (LLDPE) construction will not rust or corrode
- UV inhibitor in polyethylene (LLDPE) resin resists degrading effects of sunlight, adding years to outdoor service life
- Meet SPCC and EPA Container Storage Regulation 40 CFR 264.175
- 5-year warranty

C&M PART #	MFG PART #	MODEL	NUMBER OF DRUMS	DIMENSIONS (L x W x H)	GRATING SURFACE	WEIGHT CAPACITY (lbs)	CONTAINMENT CAPACITY (GAL)	WEIGHT (lbs)
109273	9640	P1 Plus	1	36" x 36" x 66"	-	800	70	62
109274	9612	P2 Plus	2	67.3" x 41.3" x 74"	52" x 26"	4500	66	260
109275	9636	P4 Plus	4	64.5" x 62" x 79"	52" x 52"	9000	75	440

UltraTech Ultra-IBC Hard Top® Spill Containment Unit

The Ultra-IBC Hard Top Spill Containment Unit provides spill containment for intermediate bulk containers (IBCs), tanks and other large containers. The all-polyethylene roll top offers both protection from unauthorized access as well as sun, rain and the elements. Place your IBC or tank into the unit using a forklift or other equipment, close the doors and rest easy knowing that you are protected.



The Ultra-IBC hard top spill containment unit features the “Cross of Life”, a cross of polyethylene plastic molded across the top of the spill pallet that connects the four sidewalls together. The more weight that is placed on the top of the grates, the more weight that is applied to the cross of life which in turn helps pull the sidewalls in, providing a great protection for the sidewalls.

FEATURES & BENEFITS

- Upper roll top door and lower swing-out doors combine for convenient access to the IBC
- Low profile allows safe material handling and dispensing
- Five inner polyethylene (LLDPE) columns support uniformly distributed loads of up to 8500 lbs
- Components can be easily removed for cleaning
- UV inhibitor in polyethylene (LLDPE) resin resists degrading effects of sunlight, adding years to outdoor service life
- Forkliftable, lockable, all-polyethylene design will not rust or corrode

C&M PART #	MFG PART #	DIMENSIONS (L x W x H)	GRATING SURFACE	WEIGHT CAPACITY UDL (lbs)	CONTAINMENT CAPACITY (GAL)	WEIGHT (lbs)
109271	1162	64.5" x 62" x 96"	52" x 52"	8500	360	525

*See our website for Ultra-Twin IBC Hard Top® Steel Storage Unit.



Atlantic Ultraviolet (UV) Water Purifiers



Ultraviolet technology does not rely on dangerous chemicals or heat for disinfection, making this method relatively simple, inexpensive and low maintenance. Ultraviolet purifiers utilize germicidal lamps that are designed and calculated to produce a certain dosage of ultraviolet (usually at least 16,000 $\mu\text{W}/\text{cm}^2$ but many units actually have a much higher dosage).

The Ultraviolet Water Purifiers contain one or more germicidal ultraviolet lamps. Germicidal lamps are shortwave, low-pressure tubes that produce ultraviolet wavelengths lethal to microorganisms. Approximately 95% of the ultraviolet energy emitted from germicidal lamps are at 254 nanometers, the region of germicidal effectiveness most destructive to bacteria, mold and virus. When water passes through the chamber, it is exposed to the UV light which in turn deactivates the genetic material of the microorganism, preventing them from reproducing and rendering them harmless.

Ultraviolet water disinfection is dependent on the UV light reaching the bacteria, virus and other pathogens; therefore it is crucial to filter the incoming water to improve clarity as well as periodic cleaning or replacement of the quartz sleeves. Lamp replacement is recommended after 10,000 hours of operation, and we recommend having a few spare replacement lamps for emergency situations.

If you are thinking about introducing an ultraviolet water purifier to your disinfection arsenal, we recommend that you contact your local permit-monitoring agency prior to purchase. Ultraviolet disinfection is not approved as a disinfection method in certain areas.

FEATURES & BENEFITS

- Effective at inactivating most bacteria, spores and viruses
- Physical process rather than a chemical additive—eliminates the need to handle, transport and store hazardous or corrosive chemicals
- No residuals harmful to humans or aquatic life
- User-friendly for operators and easy to install

INCLUDES

Required number of germicidal lamps

Minipure® Ultraviolet Water Purifiers

The Minipure line is compact and economical. This line is suited for point of use applications (under sink installation, water vending machines) as well as with small reverse osmosis systems, boats, recreational vehicles and other similar applications.

- 1 to 9 gallons per minute
- 304 stainless steel chamber, electropolished and passivated
- Models come equipped with Promate™ wall mounting brackets

Mighty Pure® Ultraviolet Water Purifiers

The Mighty Pure series models offer superior quality and numerous standard features such as drain plug for in place draining of purifier chamber and sight port for viewing germicidal ultraviolet lamp operation. These models can be utilized with many applications, including home water wells, laboratories, farms and ranches, boats, campgrounds and restaurants.

- 3 to 20 gallons per minute
- 316 stainless steel chamber, electropolished and passivated
- Available for operation on public power supplied throughout the world

Sanitron® Single-Chamber Ultraviolet Water Purifiers

The Sanitron series offers an exceptional value while conforming to U.S. Public Health Guidelines "Criteria for the Acceptability of an Ultraviolet Unit." Purifiers include a drain plug for in place draining, a sight port for viewing germicidal lamp operation, patented dual-action quartz sleeve wiper mechanism and removable flared head for easy disassembly. Use these in process facilities, home water wells, restaurants, schools, mobile homes, swimming pools, fish ponds, hospitals, laboratories, resorts, hotels and medical facilities. Model S2400C (401515) is available with alternate inlet/outlet fittings.

- 3 to 40 gallons per minute
- 316 stainless steel chamber, electropolished and passivated
- Models S37C (401528), S50C (401535) and S2400C (401515) are NSF/ANSI 61 & 372 Certified

Sanitron® Multi-Chamber Ultraviolet Water Purifiers

Multi-Chamber Sanitron models combine multiple S2400C (401515) Single-Chamber Sanitron models for the purpose of increased flow rate and UV treatment capabilities.

- 83 to 416 gallons per minute
- 316 stainless steel chamber, electropolished and passivated
- NSF/ANSI model S2400C (401515) is used to build models S5,000C (401530) and up

Megatron® Ultraviolet Water Purifiers

The Megatron models consist of pressure vessel chambers containing multiple germicidal ultraviolet lamps. Each model is a completely self-contained disinfection system; combine multiple chambers to handle larger flows. Megatron models come with either a manual wiper system or an automatic wiper system which permits unattended mechanical cleaning of the quartz sleeve. All Megatron models come standard with a control panel with lamp operation indicators, elapsed time indicator, removable heads, multiple drain fittings, access ports and sigh port. This line is particularly suited to large-scale disinfection of industrial and municipal water and wastewater applications.

- 70 to 335 gallons per minute of clear wastewater can be treated (clear fresh water and high purity water have higher flow rates)
- Single chamber/multi-lamp ultraviolet water purifier
- Type 316 stainless steel chamber, electropolished and passivated
- Multiple units can be plumbed for higher flow rates

Continued on Next Page

Atlantic Ultraviolet (UV) Water Purifiers (continued)



WATER PURIFIER OPTIONAL EQUIPMENT

The Guardian™ Ultraviolet Monitor provides visual indication of the level of germicidal ultraviolet energy that penetrates the quartz sleeve and water within the water purifier. The use of an ultraviolet monitor is recommended by the United States Public Health Service in "Criteria for the Acceptability of an Ultraviolet Disinfection Unit." The Guardian Ultraviolet Monitor will detect reduction of ultraviolet levels due to:

- Fouling or deposits on the quartz sleeve
- Poor ultraviolet transmission through the water due to color, turbidity and organic or other impurities
- Lamp outage, component or power failure
- Depreciation of the lamp output due to usage, which is common over lamps' 10,000 hour life

The Sentry™ Safety Monitor provides constant monitoring of the water purifier's ballast and germicidal lamp operation to give an indication of ballast and germicidal lamp status. The Sentry Safety Sensor can operate an optional Promate™ Audio Alarm and/or Solenoid Valve.

- Easy installation
- Easily adaptable for use with other water purifier brands
- Available for 120 VAC, 50/60Hz water purifiers operating with electronic ballasts

C&M PART #	MFG PART #	MODEL	MAX FLOW (GPM)	INLET/OUTLET SIZE	DIMENSIONS (L x W x H)	NSF-61 & 372 CERTIFIED (Y/N)	REPLACEMENT LAMPS	QUARTZ SLEEVES
A MINIPURE ULTRAVIOLET WATER PURIFIERS								
401518	25-1184	MIN-1	1	1/4" NPT(F)	12-3/8" x 2-1/2" x 3"	N	401466	401487
401517	25-1162	MIN-1.5	1.5	1/4" NPT(F)	15-3/8" x 2-1/2" x 3"	N	401473	401488
401516	25-1112	MIN-3	3	3/4" NPT(M)	16-1/4" x 4-1/4" x 5-9/16"	N	401473	401498
401514	25-0801	MIN-6	6	3/4" NPT(M)	22-1/4" x 4-1/4" x 5-9/16"	N	401474	401499
401524	25-1915	MIN-9	9	3/4" NPT(M)	29-3/8" x 4-1/4" x 5-9/16"	N	401452	401489
B MIGHTY PURE ULTRAVIOLET WATER PURIFIERS								
401522	25-1601	MP16A	3	3/4" NPT(M)	16-1/2" x 4-5/16" x 8-3/8"	N	401465	401498
401525	25-2291	MP22A	6	3/4" NPT(M)	22-1/2" x 4-5/16" x 8-3/8"	N	401464	401499
401527	25-3691	MP36C	12	1" NPT(M)	36-1/2" x 5-11/16" x 9-1/2"	N	401472	401500
401534	25-4901	MP49C	20	1-1/2" NPT(M)	49-1/2" x 5-11/16" x 9-1/2"	N	401469	401501
C SANITRON ULTRAVIOLET WATER PURIFIERS								
401523	25-1791	S17A	3	3/4" NPT(M)	19-3/8" x 4-5/16" x 8-3/16"	N	401465	401490
401526	25-2391	S23A	6	3/4" NPT(M)	25-3/8" x 4-5/16" x 8-3/16"	N	401464	401491
401528	25-3791	S37C	12	1" NPT(M)	39-3/8" x 5-11/16" x 9-1/2"	Y	401472	401492
401535	25-5051	S50C	20	1-1/2" NPT(M)	52-3/8" x 5-11/16" x 9-1/2"	Y	401469	401493
401515	25-0995	S2400C	40	2" NPT(M)	52-3/8" x 6-5/8" x 11-1/8"	Y	401467	401497
401530	25-4088	S5,000C	83	2" NPT(M)	52-1/8" x 17" x 15"	Y	401467	401497
401531	25-4089	S10,000C	166	2" NPT(M)	52-1/8" x 18-5/8" x 34-1/2"	Y	401467	401497
401529	25-4085	S15,000C	250	2" NPT(M)	52-1/8" x 18-5/8" x 53"	Y	401467	401497
401532	25-4090	S20,000C	333	2" NPT(M)	52-1/8" x 18-5/8" x 71-1/2"	Y	401467	401497
401533	25-4091	S25,000C	416	2" NPT(M)	52-1/8" x 18-5/8" x 90"	Y	401467	401497
D MEGATRON ULTRAVIOLET WATER PURIFIERS WITH MANUAL WIPER								
401503	24-0512A1	M50	70*	2" NPT(M)	100" x 16" x 14"	N	401468	401486
401506	24-0913A1	M90	115*	3" 150# Socket Weld Flange	100" x 16" x 16"	N	401468	401486
401508	24-1516A1	M150	200*	4" 150# Socket Weld Flange	100" x 18" x 18"	N	401468	401486
401509	24-2523A1	M250	335*	6" 150# Socket Weld Flange	102" x 21" x 26"	N	401468	401486
D MEGATRON ULTRAVIOLET WATER PURIFIERS WITH AUTOMATIC WIPER								
401504	24-0515A1	M50	70*	2" NPT(M)	100" x 16" x 14"	N	401468	401486
401505	24-0912A1	M90	115*	3" 150# Socket Weld Flange	100" x 16" x 16"	N	401468	401486
401507	24-1514A1	M150	200*	4" 150# Socket Weld Flange	100" x 18" x 18"	N	401468	401486
401510	24-2524A1	M250	335*	6" 150# Socket Weld Flange	102" x 21" x 26"	N	401468	401486

*Max flow listed is for clear wastewater. High-purity water and clear fresh water will have a higher max flow rate.

Continued on Next Page



Atlantic Ultraviolet (UV) Water Purifiers *(continued)*

The Guardian™ and Sentry™ Audio Alarm audibly alerts the user to any malfunction detected by the Guardian or Sentry monitors. Use of an audio alarm is recommended by the U.S. Public Health Service “Criteria for the Acceptability of an Ultraviolet Disinfection Unit.”

The Promate™ Time Delay Mechanism provides a 2-minute warm-up period during which the UV lamp achieves full germicidal output before the water is allowed to flow through the ultraviolet water purifier. The time delay mechanism is used in conjunction with, and is electrically connected to, the Promate solenoid valve. Use of a time delay mechanism is recommended by the U.S. Public Health Service “Criteria for the Acceptability of an Ultraviolet Disinfection Unit.”

The SureFLO™ PVC Flow Control Valves limit water flow to the rated capacity through the ultraviolet water purifier. Choose from a range of valve sizes starting at 1/2 gallon per minute to 80 gallons per minute.

The Promate™ Elapsed Time Indicator is a real-time, nonresettable display of a water purifier’s operating hours. Extremely helpful for scheduling and recording maintenance and lamp replacement.



REPLACEMENT PARTS & ACCESSORIES

C&M PART #	MFG PART #	DESCRIPTION	USE WITH MODELS
401556	30-8251	Guardian UV Monitor	All Mighty Pure Models and Sanitron Models S17A – S50C
401555	30-8250	Guardian UV Monitor	Sanitron Models S2400C & Up
401550	30-0168	Sentry Safety Sensor	Mighty Pure Models MP13A to MP36C, All Minipure Models and Sanitron Models S14A to S37C
401551	30-0170	Sentry Safety Sensor	Sanitron Models S2400C & Up
401552	30-0173A	Promate Audio Alarm	All Sanitron and Mighty Pure Models That Utilize Guardian Analog UV Monitor As Well As Sanitron, Mighty Pure and Minipure Models in Conjunction With The Sentry Safety Sensor
401554	30-1369B	Promate Time Delay Mechanism	All Minipure, Mighty Pure and Sanitron Models
401553	30-1008A	Promate Elapsed Time Indicator	All Minipure, Mighty Pure and Sanitron Models
401512	25-0390B	Promate Bracket Kit	Minipure Models MIN-1 and MIN-1.5
401513	25-0415A	Promate Bracket Kit	Minipure Models MIN-3, MIN-6 and MIN-9
401511	25-0188B	Promate Wall Mounting Kit	Mighty Pure Models MP13 – MP49C and Sanitron S14 – S50C
401521	25-1467A	Promate Wall Mounting Kit	Sanitron Models A2400, S2400B and S2400C
401450	00-1238A	Promate 22mm O-Ring	All Minipure, Mighty Pure and Megatron Models and Sanitron S17A to S50C
401519	25-1235A	Promate 22mm Teflon Washer	All Minipure, Mighty Pure and Megatron Models and Sanitron S17A to S50C
401451	00-1239A	Promate 48mm O-Ring	Sanitron Models S2400C to S25,000C
401520	25-1236A	Promate 48mm Teflon Washer	Sanitron Models S2400C to S25,000C
E SUREFLO PVC FLOW CONTROL VALVES			
401538	27-0027	1/2" NPT(M) 1 GPM	Minipure Model MIN-1
401537	27-0026	1/2" NPT(M) 1.4 GPM	Minipure Model MIN-1.5
401541	27-1401	1/2" NPT(M) 2 GPM	Mighty Pure Model MP13 and Sanitron Model S14
401542	27-1402	3/4" NPT(M) 3 GPM	Minipure Model MIN-3, Mighty Pure Model MP16A and Sanitron Model S17A
401543	27-1403	3/4" NPT(M) 6 GPM	Minipure Model MIN-6
401536	27-0016	3/4" NPT(M) 9 GPM	Minipure Model MIN-9
401544	27-1404	1" NPT(M) 12 GPM	Mighty Pure Model MP36C and Sanitron Model S37C
401545	27-1405	1-1/2" NPT(M) 20 GPM	Mighty Pure Model MP49C and Sanitron Model S50C
401540	27-1250	2" NPT(M) 40 GPM	Sanitron Model S2400C
F PROMATE SOLENOID VALVES			
401627	27-3361	3/4" NPT(F) 12 VDC Brass/Lead Free/NSF	All Minipure Models, Mighty Pure Models MP13 to MP22, Sanitron Models S14 to S23 That Utilize The Guardian Digital Ultraviolet Monitor
401628	27-3363	1" NPT(F) 12 VDC Brass/Lead Free/NSF	Mighty Pure Model MP36B and Sanitron Model S37B That Utilize the Guardian Digital Ultraviolet Monitor
401629	27-3365	1-1/2" NPT(F) 12VDC Brass/Lead Free/NSF	Mighty Pure Model MP49B and Sanitron Models S50B and S2400C That Utilize The Guardian Digital Ultraviolet Monitor
401630	27-3367	2" NPT(F) 12 VDC Brass/Lead Free/NSF	Sanitron Models S5,000C and Larger That Utilize The Guardian Digital Ultraviolet Monitor

Replacement Ballasts

Atlantic Ultraviolet Surelite™ ballasts play a critical role in the ultraviolet water purification process by ensuring the proper operation of the UV lamp. They help initiate and maintain the performance of the germicidal lamp, leading to effective water disinfection, improved energy efficiency and extended lamp life.



C&M PART #	MFG PART #	FOR USE WITH	DIMENSIONS (L x W x D)	VOLTAGE (VAC)	MOUNTING
INFILCO DEGREMONT (IDI)/OZONIA					
401480	10-0231	61862-G01	11.7" x 3.1" x 1.8"	120 to 277	Screw holes on mounting tabs
R-CAN/STERILIGHT					
401477	10-0137	BA-120, BA-539	6.5" x 1.5" x 1"	120	Slotted mounting tabs
MIGHTY PURE					
401477	10-0137	MP16, MP16A, MP22, MP22A, MP36C, MP49C*	6.5" x 1.5" x 1"	120	Slotted mounting tabs
401476	10-0091	MP49C**	8.5" x 1.7" x 1"	120	Slotted mounting tabs
SANITRON					
401477	10-0137	S17, S17a, S23, S23a, S37C, S50C*	6.5" x 1.5" x 1"	120	Slotted mounting tabs
401476	10-0091	S50C**	6.5" x 1.5" x 1"	120	Slotted mounting tabs
401479	10-0201	S2400, S2400C, S5,000C, S15,000C, S20,000C, S25,000C	11.7" x 3.2" x 1.2"	120	Slotted mounting tabs
401478	10-0155	S2400, S2400C, S5,000C, S10,000C, S15,000C, S20,000C, S25,000C	11.7" x 3.2" x 1.2"	230	Slotted mounting tabs

*Ballast replacement for Sanitron S50C and Mighty Pure MP49C units purchased after March 2017.

**Ballast replacement for Sanitron S50C and Mighty Pure MP49C units purchased before March 2017.

Replacement Quartz Sleeves

Atlantic Ultraviolet Crystal Clear™ quartz sleeves serve as protective housing for ultraviolet germicidal lamps, allowing the efficient transmission of UV light while keeping the lamp separated from the water. Over time, deposits in the water accumulate on the exterior of the quartz sleeve reducing the transmission of UV light and decreasing the effectiveness. Regular maintenance involves removing the sleeve, cleaning it and then reinstalling or replacing it.



Crystal clear quartz sleeves can be used as equivalent replacement sleeves for many brands and models of ultraviolet equipment besides Atlantic Ultraviolet's air and water purifiers.



C&M PART #	MFG PART #	LENGTH (mm)	END TYPES	FOR USE WITH
ENAQUA				
401495	15-1053	1626	Closed One End	001.0603C92, 6.2231626
INFILCO DEGREMONT (IDI)/OZONIA				
401494	15-1052	1702	Closed One End	1702D, 59545-H04
401495	15-1053	1626	Closed One End	59545-H03, 59619-G04
TROJAN/VIQUA				
401485	15-0751	610	Closed One End w/ Fitting	441143-024, UV 4000, UV 4000 Plus
401484	15-0750	692	Closed One End w/ Fitting	441143-028, UV 4000
401496	15-1054	1610	Closed One End	302208, UV 3000, UV 8000
401482	15-0458	1950	Closed One End/ Flared One End	316136, UV 3000 Plus
WEDECO				
401483	15-0552	1512	Open Both Ends	33309, TAK55
401502	15-1160	1540	Closed One End	37913, K Series, LBX-37913

Local Knowledge
Local Experience
Local Service, Nationwide®

Count on Core & Main to provide a quality product assortment from trusted brands, access to industry and product experts, and best-in-class service.



Replacement Ultraviolet Lamps

Atlantic Ultraviolet Ster-L-Ray® germicidal ultraviolet lamps (also referred to as UVC lamps) are short-wave, low-pressure tubes that produce ultraviolet wavelengths lethal to microorganisms. Approximately 95% of the ultraviolet energy emitted from germicidal lamps are at 254 nanometers, the region of germicidal effectiveness most destructive to bacteria, mold and virus.



C&M PART #	MFG PART #	LAMP MODEL EQUIVALENT	LENGTH (mm)	WATTS	BASE DESCRIPTION
AQUAFINE EQUIVALENT					
401471	05-1338A-R	3098, 3099	1554	75	Single Pin Double Ended
401472	05-1343-R	3084, 3089	843	41	Single Pin Double Ended
401459	05-0492	17998	1554	75	2 Pin with 4 Wings
AQUIONICS EQUIVALENT					
401448	05-9501	MP1020	422	3500	No Pins Single Wire
BERSON UV-TECHNIEK EQUIVALENT					
401463	05-0779	B2020	322	2000	No Pins Single Wire
401447	05-9500	B2020H	322	2000	No Pins Single Wire
401448	05-9501	B3535H	422	3500	No Pins Single Wire
401449	05-9502	B3570	784	4000	No Pins Single Wire
ENAAQUA EQUIVALENT					
401457	05-0337-R	1186	1554	155	4 Pin Single Ended
HERAEUS EQUIVALENT					
401445	05-4311	NNI 300/147, NNI 300/147XL	1554	320	4 Pin Single Ended
IDEAL HORIZONS EQUIVALENT					
401470	05-1337-R	11002, 11004	1554	75	Single Pin Double Ended
401472	05-1343-R	12003	843	41	Single Pin Double Ended
401471	05-1338A-R	12006	1554	75	Single Pin Double Ended
INFILCO DEGREMONT (IDI)/OZONIA EQUIVALENT					
401428	05-0700	61645-G01, 40 HOVLS	1554	150	No Pins Pigtail, 2 Pin Connector
401455	05-0266-R	59619-G09, L58PT-1.5	1554	75	No Pins Pigtail, 2 Pin Connector
401436	05-2005	X0016-H15	1684	400	No Pins Wires w/ Capacitor Plug
401462	05-0702	59619-G03	843	40	No Pins Pigtail, 2 Pin Connector
401444	05-4270	59619-G04	1554	75	No Pins Pigtail, 2 Pin Connector
401461	05-0701	61645-G02, X0016-H09	1554	150	No Pins, 2 Pin Connector
R-CAN/STERILIGHT EQUIVALENT					
401420	05-0532	S64RL	1554	75	4 Pin Step Single Ended - 3 Levels
401460	05-0601	S950RL-HO	1050	100	4 Pin Step Single Ended - 3 Levels

C&M PART #	MFG PART #	LAMP MODEL EQUIVALENT	LENGTH (mm)	WATTS	BASE DESCRIPTION
SUNLIGHT SYSTEMS/SIEMENS EQUIVALENT					
401433	05-0725	LP4390, 4390-LL	1554	75	4 Pin Single Ended - One Pin Higher
401427	05-0666	LP4435	838	84	4 Pin Single Ended - One Pin Higher
401423	05-0624	LP4440	1554	155	4 Pin Single Ended - One Pin Higher
401472	05-1343-R	3084	843	41	Single Pin Double Ended
401471	05-1338A-R	3098	1554	75	Single Pin Double Ended
401454	05-0264-R	LP4420, SBH-20	843	87	4 Pin Single Ended
TROJAN EQUIVALENT					
401418	05-0200A-R	302417	843	41	2 Pin Dielectric Base Single Ended
401453	05-0124-R	302418, UV3000	1554	75	2 Pin Dielectric Single Ended
401458	05-0423-R	302509, 79447-OGN	1564	256	4 Pin Step Single Ended
401471	05-1338A-R	6000080	1554	75	Single Pin Double Ended
401434	05-0736	794447-OYW	1554	285	4 Pin Single Ended Thin Barrier w/ Key
401441	05-2613	602854, G, G+, Pro 10	447	92	2 Pin Single Ended w/ 3 Wings
401442	05-2614	602855	687	140	2 Pin Single Ended w/ 3 Wings
401443	05-2615	602856, Pro 30	930	190	2 Pin Single Ended w/ 3 Wings
401437	05-2600	602803, UV Max A	279	16.4	4 Pin Single Ended Large Round w/ Barriers
401438	05-2601	602804, UV Max B	226	22	4 Pin Single Ended Large Round w/ Barriers
401439	05-2602	602805, UV Max C & D	389	40	4 Pin Single Ended Large Round w/ Barriers
401440	05-2603	602806, UV Max E Pro 7	631	68	4 Pin Single Ended Large Round w/ Barriers
ULTRA DYNAMICS EQUIVALENT					
401471	05-1338A-R	1530 UD, 7001-153	1554	75	Single Pin Double Ended
401470	05-1337-R	1580 UD, 7001-158	1554	75	Single Pin Double Ended
401419	05-0508	9410	1572	75	4 Pin Step Single Ended
401475	05-1382-R	1308 UD, 7001-803	843	41	4 Pin Single Ended
WEDECO EQUIVALENT					
401425	05-0636	XLR-5, 40718	525	40	4 Pin Connector w/ Wires Single Ended
401424	05-0629	XLR-20, 40693	985	187	4 Pin Single Ended
401421	05-0586	XLR-30, DLR30-1	1512	320	4 Pin Single Ended
401422	05-0588	39898, 6101275, ELR-30	1512	295	4 Pin Single Ended

Enchlor Series E4000 Chlorine Gas Feeders



The popular Series E4000 Chlorine Gas Feeders provide a reliable and economical alternative to lower capacity gas feed systems. Fine silver and Hastelloy-C rate valve and inlet valve components offer long life and accurate control. Solid machined PVC construction provides the most durable chlorinator available. Remote ejector and direct cylinder mounting ensure the highest degree of operator safety.

FEATURES & BENEFITS

- Industrial quality at a competitive price
- Hastelloy-C inlet valves
- Solid machined PVC construction
- All vacuum operation

INCLUDES

MFG Model E41_1C: One cylinder mounted vacuum regulator with wall mounted gas rotameter; manual rate valve and chlorine supply indicator; one ejector/diffuser assembly, 25-ft L, 3/8" vacuum and vent tubing; one vent outlet screen and one standard installation and spare parts kit (10 #GAE-LED-111 lead gaskets, one ammonia bottle for checking connections, two #GAE-BUN-106 nozzle gaskets, one #GAE-VIT-122 ejector seat, one #VRE-455-500 replacement filter, and one operation/maintenance manual)

MFG Model E41_5C: Two cylinder mounted vacuum regulators with gas rotameters and chlorine supply indicators (no rate valves); one automatic switchover module, vacuum operated; one remote mounted meter panel with gas rotameter and rate valve, one ejector/diffuser assembly, 25-ft L, 3/8" vacuum and vent tubing; one vent outlet screen and one standard installation and spare parts kit (10 #GAE-LED-111 lead gaskets, one ammonia bottle for checking connections, two #GAE-BUN-106 nozzle gaskets, one #GAE-VIT-122 ejector seat, one #VRE-455-500 replacement filter and one operation/maintenance manual)

SPECIFICATIONS

ACCURACY	4% of Max Rotameter Capacity
OPERATING RANGE	20:1, Manual
BACK PRESSURE	Max Back Pressure at Point of Application for a Standard Ejector is 140 PSI
CONNECTION (TUBING)	3/8" Vacuum and Vent
OPERATING TEMPERATURE	Ejector: 35 to 120° Other Components: -20 to 120°F

C&M PART #	MFG PART #	CAPACITY	NOZZLE
SERIES 4000 CHLORINE GAS FEED SYSTEM (VRE-400-CL2 direct cylinder mounted vacuum regulator with rate valve, EJE-100-CL2 ejector assembly)			
401896	E4171C	0 to 100 ppd	#12
401897	E4161C	0 to 50 ppd	#15
401898	E4151C	0 to 25 ppd	#13
401899	E4141C	0 to 10 ppd	#16
SERIES 4000 SWITCHOVER CHLORINE GAS FEED SYSTEM (two direct cylinder VRE-400-CL2 vacuum regulators, SOE-100-CL2 automatic switchover module, and MPE-100-CL2 remote mounted meter panel with rate valve, EJE-100-CL2 ejector assembly)			
401900	E4175C	0 to 100 ppd	#12
401901	E4165C	0 to 50 ppd	#15
401902	E4155C	0 to 25 ppd	#13
401903	E4145C	0 to 10 ppd	#16

REPLACEMENT PARTS & ACCESSORIES

C&M PART #	MFG PART #	DESCRIPTION
401904	VRE-400-CL2-100	Series 4000 Vacuum Regulator Only, 100 ppd Capacity
401905	VRE-400-CL2-50	Series 4000 Vacuum Regulator Only, 50 ppd Capacity
401906	VRE-400-CL2-25	Series 4000 Vacuum Regulator Only, 25 ppd Capacity
401907	VRE-400-CL2-10	Series 4000 Vacuum Regulator Only, 10 ppd Capacity
401908	SOE-100-CL2	Switchover Module Assembly up to 100 ppd
401909	MPE-100-CL2-100	Series 4000 Remote Meter Panel Assembly, 100 ppd Capacity
401910	MPE-100-CL2-50	Series 4000 Remote Meter Panel Assembly, 50 ppd Capacity
401911	MPE-100-CL2-25	Series 4000 Remote Meter Panel Assembly, 25 ppd Capacity
401912	MPE-100-CL2-10	Series 4000 Remote Meter Panel Assembly, 10 ppd capacity
401913	EJE-100-CL2-12	Chlorine Vacuum Ejector assembly with #12 Nozzle for 100 ppd
401914	EJE-100-CL2-15	Chlorine Vacuum Ejector assembly with #15 Nozzle for 50 ppd
401915	EJE-100-CL2-13	Chlorine Vacuum Ejector assembly with #13 Nozzle for 25 ppd
401916	EJE-100-CL2-16	Chlorine Vacuum Ejector assembly with #16 Nozzle for 10 ppd
401917	CWE-200-100	Twisted Chlorine Cylinder Wrench
401918	FLEX-100-004	4-ft Chlorine Pigtailed / Flexible Connectors
401919	FLEX-100-006	6-ft Chlorine Pigtailed / Flexible Connector
401920	FLEX-100-010	10-ft Chlorine Pigtailed / Flexible Connector
401921	HTE-111-500	Chlorine Dripleg Heater, 25 Watt, 120 VAC with 6-ft Power Cord
401922	IVE-116-500	Isolating Valve and Yoke Assembly for Chlorine
401923	MA-104-500	Chlorine Manifold Valve
401924	MAE-VRTA	Ton Container Adapter for Mounting Vacuum Regulator to Ton Container
401925	GAE-LED-1111	Lead Gasket, 1 lb



Chlorine Institute Emergency Kits

Emergency Kit A: is the sole capping kit approved by the US Department of Transportation (DOT) for legally transporting leaking chlorine cylinders on the road. This approval applies specifically to low-pressure cylinders with a rating below 150 PSI.

Manufactured to exacting standards outlined by the Chlorine Institute, the Emergency Kit-A is tailored for 100 & 150 lb capacity chlorine cylinders following DOT 3A480 and 3AA480 specifications. The kit contains specialized devices designed to halt leaks at the valve, fusible plug and within the side walls of the cylinders. Two detailed instruction booklets are included, providing clear guidance on the application of each device. Note: Authorized, trained personnel equipped with suitable respiratory equipment should investigate chlorine leaks promptly. All other persons should be restricted from the affected area.

Emergency Kit B: is the sole capping device approved by the US Department of Transportation (DOT) for the legal transportation of leaking chlorine ton containers on the road. This approval specifically applies to US DOT 106A500X concave head chlorine one ton containers.

Kit B, redesigned in 2014, incorporates devices and tools meticulously crafted for containing leaks in and around ton container valves and within the side walls of ton containers. All items are methodically labeled with part numbers, color-coded in yellow and are conveniently stored inside a durable polyethylene toolbox. Note: The Emergency Kit B is the only emergency kit for chlorine ton containers manufactured in strict adherence to The Chlorine Institute's specifications.

Emergency Kit C: is designed to effectively mitigate leaks occurring in and around the pressure relief device and angle valves of tank cars (DOT 105J500W), cargo tanks (MC331) and portable tanks (DOT 51).

Comprised of specialized devices and tools, all components in the kit are clearly labeled with part numbers, color-coded in green and conveniently housed in a durable polyethylene kit box. Note:

The Emergency Kit C is the only emergency kit for chlorine tank cars and trucks, manufactured to adhere to the stringent specifications set by the Chlorine Institute.

INCLUDES

Emergency Kit A: Hood assembly [(1V) vent valve & 1K2 screws (3)]; molded Viton® gaskets [5-7/8" OD x 4-5/8" ID (2) & 1-3/8" OD x 5/8" thick (5)]; base assembly with chains, clamp assembly (2A, 2C, 2D); Garlock 3000 gaskets [15/16" dia x 1/16" thick (5) & 1" x 3" x 1/16" thick (5)]; strap; yoke; cap screw; steel patch; 3/8 sq. box wrench, 1-1/4" open end x 7-1/4" L; straight open end wrench, 1-1/4" x 1-1/8" x 12-1/8"; combination wrench, 7/16" x 7-1/4"; machinist hammer, 3 lb; 10" hacksaw with 3 blades; drift pins [5/32" x 1/2" x 6" (2) & 7/8" x 1-1/4" x 8" (2)]; vent valve packing ring, 7/8" OD x 15/32" ID x 1/4 sq. (5); box seals kit (15); gasket sack; paint scraper, 1-1/4" blade; valve yoke; valve adapter (820-hose); valve outlet washer, 15/16" OD x 9/16" ID x 1/16" thick; plastic box; file, 8", toll roll; kit box, 35" x 13-3/4" x 14-1/4"; instruction booklet; and chlorine manual



Emergency Kit B: Molded Viton® gasket (2); 4G gasket, 15/16" dia x 1/16" thick (5); strap; yoke; cap screw; patch; Viton gaskets [7/16" dia x 3/4" thick (2) & 5" OD x 2" ID x 1/2" thick]; hood assembly (with vent valve 12V); adjustable bar assembly; Molded Viton gasket, 5-1/4" OD x 2-1/4" ID x 3/4" thick; hood; straight open-end wrench, 1-1/4" x 12" L; socket wrench, 1-1/4" hex x 11" L; wrench bar, 1" dia x 20" L; crowfoot wrench, special, 5/32" x 11" L; 3/8 sq. box wrench, 1-1/4" open end x 7-1/4" L; drift pins [9/32" x 1/2" x 6" L (2), 7/8" x 1-1/4" x 8" L (2) & 1/16" x 1-7/16" x 8" L (2)]; vent valve packing ring, 7/8" OD x 15/32" ID x 1/4" thick (5); paint scraper, 1-1/4" blade; machinist hammer, 48 oz; kit box seal (15); gasket sack; valve yoke; valve adapter; gasket, 15/16" OD x 9/16" ID x 1/16" thick (5); plastic gasket box; kit toolbox; tool roll"; instruction booklet (2); and chlorine manual

Emergency Kit C: Hood assembly with (6V) vent valve; molded Viton gaskets [7" OD x 5-3/4" ID x 3/16" wall (2) & 8" sq. x 6-1/2" ID x 3/16" wall (2)]; yoke assembly, consisting of: block, screw, cap screws (4), retainer, yoke channels (2); hood assembly with (24V) vent valve; combination wrench, 11/16" x 6-1/2"; crowfoot wrench, special, 1-9/32" x 21"; socket wrench, 1-13/16" hex x 1" sq. drive; wrench bar, 1" dia x 20"; 3/8" sq. box wrench & 1-1/4" open end x 7-1/4"; handwheel spanner device; 15" adjustable wrench; machinist hammer, 1-1/2 lb.; paint scraper, 1-1/4" blade; bolt cutter; vent valve packing ring (5); kit box seal (15); gasket sack; tool roll; kit box, 36" x 18-1/2" x 20"; instruction booklet (2); and chlorine manual

C&M PART #	MFG PART #	DESCRIPTION
401857	KIT-A	Emergency Kit A for 100-150 lb. Low Pressure Cylinder Leaks
401858	KIT-B	Emergency Kit B for 1-Ton Pressure Cylinder Leaks
401859	KIT-C	Emergency Kit C for Tank Cars/Cargo Tanks/Potable Tanks

REPLACEMENT PARTS & ACCESSORIES

C&M PART #	MFG PART #	DESCRIPTION
401872	AVGS*	Emergency Kit A Replacement Gasket Set, Viton
401873	BVGS*	Emergency Kit B Replacement Gasket Set, Viton
401874	CVGS*	Emergency Kit C Replacement Gasket Set, Viton
401875	AXGS*	Emergency Kit A Replacement Gasket Set, Viton Pre-2013 Design
401876	BXGS*	Emergency Kit B Replacement Gasket Set, Viton Pre-2014 Design
401890	TCYL	Chlorine Training Cylinder for Chlorine Institute Emergency Kit A

*All Gaskets made of Viton have a 4-year recommended shelf-life from the Chlorine Institute. Gaskets are stamped with the Date of Manufacture. There is no expiration date for the gaskets. Gaskets that are unused, have been stored at room temperature and are routinely inspected and found fully pliable and intact (without tears, splits or cracks) are assumed to be ready for emergency use.

Electrical



TABLE OF CONTENTS

Cable Protection Systems	84
Digital Panel Meters/Level Process Controllers	84-85
Generators & Power Inverters	86
Monitoring Systems	87-93
Testing Equipment	94-96

Electrical Extension Cords with Power Indicator

Extension Cords with Power Indicator feature a built-in indicator or LED light that serves as a visual signal to let you know when the extension cord is receiving power.

They can be used in both indoor and outdoor settings, but it's important to choose an extension cord that is rated for the intended use and has appropriate safety certifications.



107940D7N8BC



10794819Q3X2

C&M PART #	MFG PART #	COLOR	LENGTH (ft)	GAUGE/ PHASE	POWER INDICATOR	TRADES
107940D7N8DG	10/3-100	Yellow	100	10/3	Yes	SJTW
107940D7N8BC	10/3-50	Yellow	50	10/3	Yes	SJTW
107940D7N8X2	10/3-25	Yellow	25	10/3	Yes	SJTW
107943D7Q3DG	12/3-100	Yellow	100	12/3	Yes	SJTW
107943D7Q3BC	12/3-50	Yellow	50	12/3	Yes	SJTW
107943D7Q3X2	12/3-25	Yellow	25	12/3	Yes	SJTW
10794619Q3DG	12/3-100-HDBLUE	Blue	100	12/3	Yes	SJTW
10794619Q3BC	12/3-50-HDBLUE	Blue	50	12/3	Yes	SJTW
10794819Q3DG	12/3-100-EXTBLUE	Blue	100	12/3	Yes	SJEOW
10794819Q3BC	12/3-50-EXTBLUE	Blue	50	12/3	Yes	SJEOW
10794819Q3X2	12/3-25-EXTBLUE	Blue	25	12/3	Yes	SJEOW

UltraTech Ultra-Sidewinder Cable Protection System®



The Ultra-Sidewinder Cable Protection System offers an innovative solution for protecting cables on the floor and reducing trip hazards for pedestrians.



The pieces articulates from left to right, allowing the system to turn corners and adapt easily to the layout of the room. Cables can be left in the system for the ultimate in portability, or left in place indefinitely.

FEATURES & BENEFITS

- Simple "snap in" assembly, no tools or cutting required
- Modular design for easy configuration to fit the design you need
- UV resistant—use indoors or outdoors

C&M PART #	MFG PART #	SIZE	COLOR	DIMENSIONS (L x W x H)	WEIGHT (lbs)	WEIGHT CAPACITY UDL (lb/in ²)
109334F84Q	1800	Small	Black/ Yellow	39.5" x 3" x 0.8"	1.5	2,000
109334174Q	1802	Small	Black	39.5" x 3" x 0.8"	1.5	2,000
109334F8MD	1830	Medium	Black/ Yellow	33" x 9.8" x 1.4"	6	260
109334F8SR	1840	Large	Black/ Yellow	34" x 13.6" x 2.1"	13.5	260

Precision Digital PD765 Trident Digital Panel Meter / Level Process Controller

The PD765 Trident Digital Panel Meter is one of the most versatile digital panel meters on the market and will satisfy a wide variety of process and temperature applications. Easily field program meter to accept process voltage (0 to 5 V, 1 to 5 V, etc.); current (4 to 20 mA); 100 Ω RTDs or type J, K, T, or E thermocouple inputs.



Program and setup using the four front panel pushbuttons or by using the free MeterView™ software. Password protection restricts modification of programmed settings. Units with relay output option have functionalities that include automatic reset only, auto/manual reset, latching/non latching, pump alternation control, on/off time delays from 0 to 199 seconds and fail-safe operation. Adjust the intensity of the display to compensate for various lighting conditions, including direct sunlight.

FEATURES & BENEFITS

- Provides 24 VDC to power the transmitter's 4 to 20 mA signal
- 1/8 DIN panel meter with NEMA 4X, IP65 front
- Shallow depth case extends only 3.6" (91.4 mm) behind panel
- 4-digit LED display, 0.56" (14.2 mm) H
- Free PC-based MeterView programming & monitoring software
- High & low alarms with multiple reset actions
- Max/Min display

SPECIFICATIONS

ACCURACY	±0.05% of Calibrated Span
POWER	85 to 265 VAC
DISPLAY	0.56", 4-Digits, Red LED (-1999 to 9999)
ENCLOSURE	NEMA 4X, 1/8 DIN, Plastic
INPUTS (FIELD SELECTABLE)	4 to 20 mA; ±10 VDC; 0 to 5 VDC; 1 to 5 VDC; J, K, T or E Thermocouple; or 100 Ω Platinum RTD
RELAYS	2 SPDT, Form C
RATING	3 A @ 250 VAC Resistive
DEADBAND	0 to 100% of Full Scale, User Selectable
OPERATION	Automatic, Latching, Pump Alternation
TIME DELAY	0 to 199 Seconds On or Off
RESET	Auto or Manual, User Selectable
OPERATING TEMPERATURE RANGE	-40 to 65°C (-40 to 150°F)

CERTIFICATIONS

- CE, UL, cUL

C&M PART #	MFG PART #	OPTIONS INSTALLED
1072790605	PD765-6R0-00	None
1072790601	PD765-6R0-10	24 VDC Transmitter Supply
1072790105	PD765-6R2-00	2 Relay Outputs
1072790101	PD765-6R2-10	2 Relay Outputs, 24 VDC Transmitter Supply
1072790205	PD765-6R3-00	4 to 20 mA Output
1072790201	PD765-6R3-10	4 to 20 mA Output, 24 VDC Transmitter Supply
1072790401	PD765-6R5-10	2 Relay Outputs, 4 to 20 mA Output, 24 VDC Transmitter Supply



Precision Digital ProVu Digital Panel Meter / Level Process Controller

The ProVu meters boast specifications, features and functionalities that make it the only 1/8 DIN process meter you will ever need. They accept both current and voltage input signals and are ideal for level, flow rate, temperature or pressure applications. The built-in 24 VDC power supply to drive transmitter not only saves the cost of an external power supply, but also greatly simplifies wiring.



The NEMA 4X rated front panel allows for installations exposed to moisture, dust, and other adverse conditions. View up to 999,999 on the upper line of the 6-digit dual-line LED display and show either a tag or the input in a different scale on the lower line. Configure the main display to indicate process value, resettable maximum or minimum value, alternating or alarm set points. Secondary display can be set to indicate engineering units, setpoints or user-defined legends or simply turned off. Other key features include advanced signal input conditioning like automatic round horizontal tank linearization (enter diameter and length), function keys, pump alternation capability and Modbus RTU serial communications. All models feature time delays for each relay and adjustable deadbands. Choose from controllers with one or two input channels; each input is programmed independently.

FEATURES & BENEFITS

- 0 to 20 mA, 4 to 20 mA, 0 to 5 V, 1 to 5 V and ± 10 V field selectable inputs
- Math functions include: addition, difference, average, multiplication, division, weighted average, ratio, concentration, and more
- Easily view Minimum or Maximum values
- Large 6-digit, dual-line LED display, 0.60" & 0.46"
- Programmable Display & Function Keys
- Modbus RTU Communication Protocol Standard
- Onboard USB and free PC-based, MeterView® Pro USB Programming Software

INCLUDES

USB cable.

SPECIFICATIONS

ACCURACY	$\pm 0.03\%$ of calibrated span, ± 1 count
POWER	85 to 265 VAC
DISPLAY	Upper Display 0.60", Lower Display 0.46"
ENCLOSURE	NEMA 4X, IP65 front, 1/8 DIN
INPUTS (ANALOG, FIELD SELECTABLE)	1 or 2 (Depending on Model); 4 to 20 mA, 0 to 5 VDC, 1 to 5 VDC, 0 to 10 VDC
INPUTS (DIGITAL)	1
RELAYS	2 or 4 SPDT, Form C (Depending on Model)
RATING	3 A @ 125/250 Resistive Load
DEADBAND	0 to 100% of Span, User Adjustable
OPERATION	Auto, Latching, Sampling, Pump Alternation Control, Off, Manual Control Mode
TIME DELAY	0 to 999.9 Seconds, On and Off Relay
RESET	Auto or Manual, User Selectable
MEMORY	Nonvolatile, 10 years
OPERATING TEMPERATURE RANGE	-40 to 65°C (-40 to 150°F)

CERTIFICATIONS

- UL, cUL

C&M PART #	MFG PART #	OPTIONS INSTALLED (24 VDC TRANSMITTER POWER SUPPLY IS STANDARD ON ALL MODELS)
PROVU DISPLAY/CONTROLLERS WITH SINGLE INPUT		
1072860101	PD6000-6R2	2 Relay Outputs
1072860402	PD6000-6R5	2 Relay Outputs, 4 to 20 mA Output
1072860301	PD6000-6R4	4 Relay Outputs
1072860502	PD6000-6R7	4 Relay Outputs, 4 to 20 mA Output
PROVU DISPLAY/CONTROLLERS WITH DUAL INPUT		
1072900101	PD6060-6R2	2 Relay Outputs
1072900402	PD6060-6R5	2 Relay Outputs, 4 to 20 mA Output
1072900301	PD6060-6R4	4 Relay Outputs
1072900502	PD6060-6R7	4 Relay Outputs, 4 to 20 mA Output

PIVOT YOUR THINKING

See the **Pumps** section for Zoeller Pivot® 1-Phase and Pivot® Pro 1-Phase and 3-Phase Control Panels on **page 296**.



Generac Portable Generators



105018



105019



105024



Generac is well-known for its standby and portable generators. Use these generators as backup power solutions in residential, commercial, and industrial settings.

Inverter Generators are known for their quiet operation and clean power output. They are suitable for sensitive electronics and appliances.

Portable Generators are designed to be mobile and are typically used for activities such as camping, construction, or providing temporary power during emergencies.

INCLUDES

Engine oil, oil funnel, wheel & handle kit and manual; Some models also include ControlGuard™ (provides added protection to the control panel) and charging cable

ORDERING TABLE & SPECIFICATIONS

C&M PART #	105017	105018	105019	105020	105021	105022	105023	105024
MFG PART #	G008250	G007154	G007128	G007127	G007677	G007682	G007686	G007247
MODEL	GP2500i	GP3300i	GP3500iO	iQ3500	GP3600	GP6500E	GP8000E	XT8500E
GENERATOR TYPE	Inverter	Inverter	Inverter	Inverter	Portable	Portable	Portable	Portable
CONFIGURATION	50 ST/CSA	50 ST/CSA	50 ST/CSA	50 ST/CSA	49 ST/CSA	49 ST/CSA	49 ST/CSA	50 ST
OUTPUT OUTLETS	2	5	5	5	5	5	5	5
NUMBER OF OUTLETS	1	2	2	2	5	5	5	5
ENGINE	OHV	OHV	OHV	OHV	OHV	OHV	OHV	EFI
RUNNING WATTS	2200	2500	3000	3000	3600	6500	8000	8500
STARTING WATTS	2500	3300	3500	3500	4500	8125	10,000	10,000
AC VOLTAGE	120 VAC	120 VAC	120 VAC	120 VAC	120 VAC	120/240 VAC	120/240 VAC	120/240 VAC
AC FREQUENCY	60 Hz	60 Hz	60 Hz	60 Hz	60 Hz	60 Hz	60 Hz	60 Hz
VAC AMPERAGE	18.3	20.83	25	25	30A	54.2/27.1	66.6/33.3	70.8/35.4
ENGINE DISPLACEMENT	98 cc	149 cc	212 cc	212 cc	212 cc	389 cc	420 cc	N/A
RPM	Variable	Variable	Variable	Variable	3600	3600	3600	3600
RECOMMENDED OIL	10W-30	10W-30	10W-30	10W-30	10W-30	10W-30	10W-30	10W-30
OIL CAPACITY	0.36 qt	0.6 qt	0.6 qt	0.6 qt	0.63 qt	1.06 qt	1.06 qt	1.05 qt
STARTING	Recoil	Recoil	Recoil	Electric/Recoil	Recoil	Electric/Recoil	Electric/Recoil	Electric/Recoil
BATTERY	N/A	N/A	N/A	12V DC, 9Ah	N/A	12V DC, 9Ah	12V DC, 9Ah	12V DC, 9Ah
FUEL TANK CAPACITY	1 Gal	1.06 Gal	2.37 Gal	2.6 Gal	3.7 Gal	6.9 Gal	7.9 Gal	8 Gal
FUEL TYPE	Gas	Gas	Gas	Gas	Gas	Gas	Gas	Gas
RUN TIME AT 50%	4.5 hr	4.5 hr	8 hr	8.9 hr	9.3 hr	10.5 hr	10 hr	9 hr
UNIT WEIGHT	48 lbs	59.5 lbs	74.3 lbs	109.1 lbs	105 lbs	182 lbs	198 lbs	214 lbs
SHIPPING WEIGHT	56 lbs	65 lbs	80.7 lbs	120.2 lbs	112 lbs	200 lbs	214 lbs	230 lbs
WARRANTY (RESIDENTIAL)	3 Year	3 Year	3 Year	3 Year	3 Year	3 Year	3 Year	3 Year
WARRANTY (COMMERCIAL)	1 Year	1 Year	1 Year	3 Year	1 Year	1 Year	1 Year	1 Year

Sensaphone® 400 & 800 Monitoring Systems

These Monitoring Systems offer small business owners, vacation property owners and other property managers an easy and inexpensive way to monitor a remote facility. Program the system to alert personnel by phone when an undesirable temperature or other set conditions need attention.

The Sensaphone 400 and 800 units provide four and eight external inputs, respectively, that allow users to connect to a variety of sensors to monitor temperature, water, humidity and more. Each zone can be calibrated, enabled or disabled individually with fully automatic input configuration. The system can monitor for power failures and listen for high sound levels. With built-in status LEDs, each monitored condition is easily read at the installation site or remotely by telephone. With built-in surge protection on all zones, the unit power supply and the connected telephone line guard against voltage spikes.



FEATURES & BENEFITS

- Receive voice alerts and alarm notifications over standard telephone lines
- Record custom voice alerts and receive alarm messages in your own voice
- Included relay output can switch local devices on/off based on alarm activity
- Internal battery backup system provides 24 hours of continuous monitoring and alerts in the event of a power outage

INCLUDES

24-hr battery backup and a pre-installed temperature probe

SPECIFICATIONS

COMMUNICATION METHOD	Phone Line
OUTPUT RELAY	One Low Voltage NO/NC Relay Output, Manual or Automatic Alarm Switching
INPUT TYPES	Contact and 2.8K
TEMPERATURE SENSING RANGE (°F)	-20 to 150
OPERATING TEMPERATURE RANGE (°F)	32 to 122
POWER	120 VAC, Internal Battery Backup Requires Six 'C' Cell Batteries (Not Included)
SOUND MONITOR	Built-In Microphone
DIMENSIONS (L x W x H)	2.1" x 7.8" x 8.8"
WEIGHT (lbs)	2
WARRANTY	1 Year

C&M PART #	MFG PART #	DESCRIPTION	NUMBER OF ALARM INPUTS	ALARM NOTIFICATION
707329	FGD-0400	400 Model	4	Four custom voice phone calls
707330	FGD-0800	800 Model	8	Eight custom voice phone calls

Sensaphone® 1400 & 1800 Monitoring Systems

Use these 1400 and 1800 Monitoring Systems for monitoring and alarm and event logging—ideal for watching over unattended or remote locations. The systems monitor equipment and environmental conditions using four or eight universal inputs with scaleable range, built-in power failure detection and sound level monitoring.



These units can read status from digital or analog input sensors including on/off status, open/closed conditions, actual temperatures and real-time values such as tank levels or flow rates. All programming is stored in nonvolatile memory so that it is retained even without power. Both 1400 and 1800 models are capable of performing alarm event logging of all inputs, power and sound. The event logging is also stored in nonvolatile memory. The alarm event history can be heard through the built-in speaker or remotely over the telephone. Use the relay output for automatic or manual control of external devices.

FEATURES & BENEFITS

- Rugged, weatherproof NEMA 4X enclosure offers protection in harsh environments
- Receive voice alerts and alarm notifications over standard telephone lines
- Internal rechargeable battery backup system provides 24 hours of continuous monitoring and alerts in the event of a power outage

INCLUDES

24-hour battery backup and a weatherproof temperature sensor

SPECIFICATIONS

COMMUNICATION METHOD	Phone Line
OUTPUT RELAY	One Universal Input Relay, Manual or Automatic Alarm Switching
INPUT TYPES	Contact, 2.8K, 10K and 4 to 20 mA
TEMPERATURE SENSING RANGE (°F)	-109 to 168
OPERATING TEMPERATURE RANGE (°F)	32 to 122
POWER	120 VAC
SOUND MONITOR	External Microphone Required
ALARM NOTIFICATION	Eight Custom Voice Phone Calls
WARRANTY	2 Years

C&M PART #	MFG PART #	DESCRIPTION	NUMBER OF ALARM INPUTS	DOOR TYPE	DIMENSIONS (L x W x H)	WEIGHT (lbs)
707333	FGD-1400-CD	1400 Model	4	Clear	7.3" x 11.7" x 4.4"	4.6
707334	FGD-1400-SD	1400 Model	4	Solid	7.3" x 11.7" x 4.4"	4.6
707335	FGD-1800-CD	1800 Model	8	Clear	8" x 12.3" x 5.6"	6
707336	FGD-1800-SD	1800 Model	8	Solid	8" x 12.3" x 5.6"	6

Sensaphone® Cloud-Based Sentinel & Sentinel PRO Monitoring Systems



The Cloud-Based Sentinel and Sentinel PRO Monitoring Systems provide convenient web-based monitoring of remote facilities and environments. Store all readings in the cloud for access from anywhere; easily access via internet connected to a computer or download a mobile App to easily access your readings on your mobile device. Multiple devices can be programmed from one powerful web-based interface. All programming and device data is stored in the cloud so that it is retained even without power. Both models monitor AC power, online status and battery backup conditions.

The Sentinel systems can monitor equipment and environmental conditions using twelve universal zones with scalable range, built-in power failure detection and one relay output for manual control or automatic control from alarms. LED indicators show the operating status of the unit; each monitored zone has its own status LED indicating that zone's alarm status.

Order the Sentinel PRO to monitor and deliver alarms and logs input/output points from third-party Modbus sensors, transducers and programmable logic controllers. In addition to the 12 digital or analog inputs, it can monitor up to 64 Modbus registers from sensors, equipment or controllers. The Sentinel PRO has two programmable relay outputs for manual control or automatic control from alarms.

The Sentinel and Sentinel PRO monitoring systems are available in ethernet and cellular communication options. The ethernet Sentinel and Sentinel PRO offer two subscription levels through the manufacturer: free and premium. Users have full use and visibility of their device's data regardless of their subscription level, but an upgrade to a premium subscription includes additional features such as unlimited storage, advanced reporting and phone call and text message alarm notification options.

Purchase of any cellular Sentinel or Sentinel PRO requires the purchase of a service plan through the manufacturer. Upon receipt of your Sentinel system, you will receive information to subscribe and activate your service plan via the web. If you have any questions about subscribing to a Premium Ethernet Plan or Cellular Service Plan, call us at 888-885-2673.

FEATURES & BENEFITS

- A supervised internet connection ensures the systems are online and monitoring at all times
- Notifies an unlimited number of people by e-mail, text message or phone calls in the event of an alarm
- Available with an optional cellular modem where telephone or internet service is unobtainable
- Manage multiple units, make programming changes and access status conditions using a simple, powerful web-based interface
- Available in a NEMA 4X enclosure for installation in wet or dirty environments
- Internal rechargeable battery-backup system will provide 8 hours of continuous remote monitoring and alerting in the event of a power outage



INCLUDES

8-hour battery backup

SPECIFICATIONS

MODEL	SENTINEL	SENTINEL PRO
COMMUNICATION METHOD	Ethernet or Cellular Service	Ethernet or Cellular Service
NUMBER OF INPUTS	12	12 Digital or Analog; 64 Modbus Registers
INPUT TYPES	Contact, 2.8K, 10K and 4 to 20 mA	Modbus RTU/485 and Modbus TCP; Contact, 2.8K, 10K and 4 to 20 mA
OUTPUT RELAY	1 NO/NC relay output, rated @ 1A, 30VAC/DC, Manual or Automatic Alarm Switching	2 NO/NC relay output, rated @ 1A, 30VAC/DC, Manual or Automatic Alarm Switching
OPERATING TEMPERATURE RANGE (°F)	32 to 122	32 to 122
POWER	12 VDC	12 VDC
ALARM NOTIFICATIONS	Unlimited Number of Email, Texts or Voice Phone Calls (Text and Phone Calls Only Available with Premium Plan)	Unlimited Number of Email, Texts or Voice Phone Calls (Text and Phone Calls Only Available with Premium Plan)
WARRANTY	2 Years	2 Years

Continued on Next Page



Sensaphone® Cloud-Based Sentinel & Sentinel PRO Monitoring Systems *(continued)*

C&M PART #	MFG PART #	CELLULAR CARRIER	ENCLOSURE TYPE	DIMENSIONS (L x W x H)	WEIGHT (lbs)
SENTINEL ETHERNET SYSTEMS					
707347	SCD-1200	-	None	5.5" x 6.3" x 1.5"	1
707348	SCD-1200-CD	-	NEMA 4X w/ Clear Door	9.5" x 11.1" x 3.5"	6
707349	SCD-1200-SD	-	NEMA 4X w/ Solid Door	9.5" x 11.1" x 3.5"	6
SENTINEL WITH CELLULAR MODEM SYSTEMS					
707350	SCD-1200-4GATCD	AT&T® 4G	NEMA 4X w/ Clear Door	12.5" x 12.2" x 7"	10.5
707351	SCD-1200-4GATSD	AT&T 4G	NEMA 4X w/ Solid Door	12.5" x 12.2" x 7"	10.5
707352	SCD-1200-4GVZCD	Verizon 4G	NEMA 4X w/ Clear Door	12.5" x 12.2" x 7"	10.5
707353	SCD-1200-4GVZSD	Verizon 4G	NEMA 4X w/ Solid Door	12.5" x 12.2" x 7"	10.5
SENTINEL PRO ETHERNET SYSTEMS					
707354	SCD-PRO	-	None	6.5" x 6.25" x 1.5"	1
707355	SCD-PRO-CD	-	NEMA 4X w/ Clear Door	9.5" x 11.1" x 3.5"	6
707356	SCD-PRO-SD	-	NEMA 4X w/ Solid Door	9.5" x 11.1" x 3.5"	6
SENTINEL PRO WITH CELLULAR MODEM SYSTEMS					
707357	SCD-PRO-4GATCD	AT&T 4G	NEMA 4X w/ Clear Door	12.5" x 12.2" x 7"	10.5
707358	SCD-PRO-4GATSD	AT&T 4G	NEMA 4X w/ Solid Door	12.5" x 12.2" x 7"	10.5
707359	SCD-PRO-4GVZCD	Verizon 4G	NEMA 4X w/ Clear Door	12.5" x 12.2" x 7"	10.5
707360	SCD-PRO-4GVZSD	Verizon 4G	NEMA 4X w/ Solid Door	12.5" x 12.2" x 7"	10.5

REPLACEMENT PARTS & ACCESSORIES

C&M PART #	MFG PART #	DESCRIPTION
707361	FGD-4GLTE-AT	4G LTE Cellular Modem with Battery Backup for AT&T
707362	FGD-4GLTE-VZ	4G LTE Cellular Modem with Battery Backup for Verizon
707345	FGD-0260	4G/LTE High Gain Omni Directional Antenna for Sentinel with 4G Cellular Modem

**TALK TO AN
EXPERT TODAY!**

Need application advice or help to locate a part? Contact our technical specialists, they are here to help!

1-888-885-2673

Sensaphone® Express II Monitoring System

The Flexible Express II Monitoring System is an ideal choice for facilities that are planning to expand in the future. The system includes eight inputs and one output as standard but is expandable to include as many as 40 total input/output channels. Read status from digital or analog sensors including on/off status, open/closed status, actual temperatures and real time values such as tank levels or flow rates. The system can also monitor sound levels, the internal battery condition and detect power failures. The Express II offers temperature sensing across a range from -85 to 300°F.

Record customized descriptive alert messages on as many as 48 user-programmable dial-out numbers, allowing unique alarm messages in their own voice with custom dialing options for each alarm input. Special dialing schedules and a phone contact list feature allow users to create their own priority dialing lists depending on which alarm input is activated and when.



INCLUDES

12-hour battery backup and a microphone

SENSAPHONE®
PRECISE MONITORING SOLUTIONS

SPECIFICATIONS

COMMUNICATION METHOD	Phone Line
NUMBER OF INPUTS	8 Standard, Expandable to 40
INPUT TYPES	Contact, 2.8K, 10K and 4 to 20mA
OUTPUT RELAY	One Universal Output Relay Standard, Expandable to 17 Total, Manual or Automatic Alarm Switching
OPERATING TEMPERATURE RANGE (°F)	32 to 120
POWER	12 VDC
ALARM NOTIFICATIONS	48 Custom Voice Phone Calls
WARRANTY	1 Year

C&M PART #	MFG PART #	DIMENSIONS (L x W x H)	WEIGHT (LB)
707337	FGD-6700	14.5" x 13" x 8.3"	18

REPLACEMENT PARTS & ACCESSORIES

C&M PART #	MFG PART #	DESCRIPTION
EXPRESS II INPUT CARDS		
707338	FGD-0035	Slot 2, Adds Inputs 9 to 16
707339	FGD-0036	Slot 3, Adds Inputs 17 to 24
707340	FGD-0037	Slot 4, Adds Inputs 25 to 32
707341	FGD-0038	Slot 5, Adds Inputs 33 to 40
EXPRESS II OUTPUT CARDS		
707342	FGD-0040	Slot 1, Adds Outputs 1 to 8
707343	FGD-0041	Slot 2, Adds Outputs 9 to 16



FEATURES & BENEFITS

- Allows for future expansion with up to 40 total inputs and up to 16 output zones
- Increase monitoring capability with easy-to-install expansion input and output cards
- Included relay output can switch local devices on/off based on alarm activity
- Rugged, weatherproof NEMA 4X enclosure offers protection in harsh environments
- Internal rechargeable battery-backup system provides 12 hours of continuous monitoring and alerts in the event of power outages



Sensaphone® Web600 Monitoring System



The Sensaphone Web600 Monitoring System is an easy, cost effective, network-based monitoring system that notifies the user when equipment or conditions go awry. The system can monitor temperatures ranging from -109 to 168°F as well as humidity, air quality, water detection and more. The Web600 website allows users to make programming changes, access status conditions and review data logs online through any web-enabled PC.

The Web600 unit can read status from six digital or analog sensors including on/off status, open/closed conditions, actual temperatures and real-time values such as tank levels, air pressure, voltage or flow rates. In the event of an alarm, the system can notify as many as eight people by e-mail, text message or SNMP trap. The device allows eight profiles with four contacts per profile. Order rechargeable battery backup that provides up to two hours of monitoring and alerts in the event of power outage (required for power failure monitoring).

FEATURES & BENEFITS

- Datalogger records up to 100,000 samples, including data, date and time
- Receive alarm notifications through a standard Internet connection
- Make programming changes and access status conditions online

SPECIFICATIONS

COMMUNICATION METHOD	Ethernet
NUMBER OF INPUTS	6
INPUT TYPES	Contact, 2.8K, 10K and 4 to 20 mA
ALARM NOTIFICATION	32 Alarm Destinations, Any Combination of E-mail, Email-to-Text or SNMP Traps
OPERATING TEMPERATURE RANGE (°F)	32 to 122
POWER SUPPLY	120 VAC
WARRANTY	1 Year

C&M PART #	MFG PART #	DIMENSIONS (L x W x H)	WEIGHT (lbs)
707331	FGD-W600	5.5" x 3.25" x 1.25"	0.5

REPLACEMENT PARTS & ACCESSORIES

C&M PART #	MFG PART #	DESCRIPTION
707332	FGD-W610-B	Web600 Battery Backup

Sensaphone Autodialer Accessories



The **Ethernet-to-Wi-Fi Adapter** can be used with all wired network based Sensaphone models to provide Wi-Fi access. The adapter allows you to place your Sensaphone units in a location where the required Ethernet connection may not be available, but a Wi-Fi signal is available. The adapter features an IP65-rated weatherproof housing that ensures continued operation in harsh outdoor environments or in climates of extreme cold, heat or continuous moisture. The kit contains a power supply and pole or wall mounting hardware. Adapter connects to the Sensaphone remote monitoring system via an Ethernet cable (not included).

- Connects any network based Sensaphone to Wi-Fi
- Program the adapter to connect with a Wi-Fi network via downloadable software
- Use a second Wi-Fi adapter to strengthen the Wi-Fi signal for monitoring units set up far from the Wi-Fi router

The **4G/LTE High Gain Omni Directional Antenna** can help to extend the range of the Sentinel unit with a 4G cellular service. Versatile and easy to install, the antenna can be easily mounted on a wall or pole. It is ideal for use when your Sentinel is mounted in locations that may interfere with the cellular coverage.

- Helps to extend the cellular signal strength
- 20-ft long cable allows antenna to be placed in location that gets a better signal

The **3G/4G/LTE External Antenna** provides improved wireless performance for Sensaphone monitoring cellular devices. The included 5-m long cable allows the antenna to be mounted away from the Sensaphone units. A wall/mast mount bracket is standard, but it can also be mounted on metal panels or enclosures of sufficient size.

- Provides improved wireless performance for Sensaphone cellular devices
- Allows the Sensaphone to be placed into a metal cabinet or other location where cellular reception may not be best
- Should be mounted 6 feet away from Sensaphone unit for best performance

C&M PART #	MFG PART #	DESCRIPTION	DIMENSIONS (W x H x D)
707344	FGD-0250-U	Ethernet-to-WiFi Adapter Accessory	3.9" x 7.3" x 1.14"
707345	FGD-0260	4G/LTE High Gain Omni Directional Antenna	2.3" x 9.8" x 2.3"
707346	FGD-0261	3G/4G/LTE External Antenna	6.46" x 1.59" x 6.46"

RACO® Verbatim® Monitoring Systems

The Verbatim Monitoring Systems offer pace setting functionality and expandability as an autodialer alarm system, a remote monitoring system, a supervisory control system, a SCADA system and a PLC network. With an expandable, modular bus architecture and up to 32 digital inputs, 16 analog inputs and 8 digital control outputs, the system can monitor flow, level, pressure, temperature, pH and other types of sensors as well as control remote electrical devices.

The system is designed to continuously monitor preset alarm points. If an alarm condition is sensed at a monitored point, it will automatically dial a list of 16 preprogrammed emergency telephone numbers, calling until it gets an answer. When the call is answered and acknowledged, the system reports the alarm location and status via a digitally prerecorded message made by the user.

You are never out of touch with the Verbatim monitoring system. Call in for a status report, review and change programming, or control a remote device using any standard touch-tone phone. With the touch of a key, you can listen to local sounds or talk to personnel using the built-in speakerphone. When calling for status reports you hear a comprehensive summary of all conditions monitored by the system, including internal power. Hard copies of event data—alarms, acknowledgements, inquiries and programming changes—can be printed out at any time using the system's datalogging capabilities.

Install up to 8 digital control outputs to remotely actuate HVAC systems, pumps, compressors and other electrical devices from a standard phone, the Verbatim front panel or a PC.

RACO HMI/SCADA Systems provide monitoring and control of an unlimited number of Verbatim Remote Terminal Units (RTUs) over the standard dial up telephone network. Each RTU has full alarm monitoring, reporting and autodialing capabilities, and because Verbatim systems report by exception, they do not need to be polled. When an alarm is sensed, the RTU reports to the central computer. If the computer operator does not acknowledge the alarm, the RTU will commence autodialing.



FEATURES & BENEFITS

- Monitors four channels plus internal AC power
- Expandable, modular design
- Superior surge protection on all units
- Remote programming for added convenience

INCLUDES

20-hour battery back up

SPECIFICATIONS

COMMUNICATION METHOD	Landline, Wireless with Cellularm®
OPERATING TEMPERATURE (°F)	20 to 130
POWER	12 VDC
DIMENSIONS (W x H x D)	9-3/4" x 11-7/8" x 5"
WEIGHT (lbs)	8
NOTIFICATION METHODS	PA System, Pager, Voice Call
WARRANTY	5 Years

CERTIFICATIONS

- UL Standards: 1459, 1950

C&M PART #	MFG PART #	NUMBER OF DIGITAL ALARM INPUTS
400166	VSS-4C	4
400167	VSS-8C	8
400168	VSS-16C	16
400169	VSS-24C	24
400170	VSS-32C	32

NEED HELP FINDING AN ITEM?

SHOP
CORE & MAIN
SUPPLY



Core & Main has access to thousands of products from hundreds of suppliers.

Check out our full assortment of products and suppliers online at supply.coreandmain.com or speak with one of our customer service representatives at **1-888-885-2673**.



RACO® Cellularm® Communications Unit

The Cellularm Communication Unit is a next generation, out-of-the-box plug and play Plain Old Telephone Service (POTS) to cellular converter that allows you to maintain your traditional landline autodialer without the messy and expensive landline phone bill. The Cellularm unit is an enterprise-grade router that simultaneously leverages both the voice and data networks for POTS line replacement. Pair with a third-party line manager to allow for redundancy in case either one of the communication protocols fails.



Order the large NEMA 4X enclosure (401765) with custom backplate and configuration for an integrated solution with both an autodialer and Cellularm unit. The enclosure supports RACO Verbatim, Verbatim Gateway, Guard-IT and Catalyst autodialers models. It unit does not include the Cellularm unit or autodialer hardware. Those items must be ordered separately but if ordered together will be delivered with specific hardware mounted inside enclosure.

FEATURES & BENEFITS

- Plug and play- simply plug your RACO analog autodialer (Verbatim, Verbatim Gateway, Catalyst or Guard-IT) in and it works
- Affordable annual subscription
- Advanced 16khz HD audio for DTMF tone devices
- PSTN Device ready-compatible with existing standard POTS/PTSN equipment
- All devices are secured over the LTE network

SPECIFICATIONS

BATTERY BACKUP	40-hours on standby, 2.5-hours when transmitting
CONNECTION MODE	RJ-11 Phone Sockets
OPERATING TEMPERATURE (°F)	14 to 140
MATERIAL	Black Powder-Coated Galvanized Steel
POWER	12 VDC
POWER SUPPLY	Mean Well GST25A12-P1J
DIMENSIONS (L x W x H)	6.69" x 4.65" x 1.18"
WEIGHT (lbs)	1.6

CERTIFICATIONS

- FCC identifier: 2ALP-8848 FCC and Rule Parts 24E, 27

C&M PART #	MFG PART #	DESCRIPTION
401764	BCELL-LTEG2	Cellularm Communications Unit

REPLACEMENT PARTS & ACCESSORIES

C&M PART #	MFG PART #	DESCRIPTION
401765	BCELL-NEMA4X	NEMA 4X Integrated Enclosure
401766	BCELL-SILTE-ATT	AT&T Cellularm Service Subscription, 1 Year
401767	BCELL-SILTE-VZ	Verizon Cellularm Service Subscription, 1 Year

RACO® AlarmAgent™ Wireless Remote Terminal Unit (RTU)

The AlarmAgent monitoring system is a wireless, web-based alarm detection and notification system designed specifically for water and wastewater pump applications. It provides dependable, real-time alarm monitoring and detection with highly customizable notification preferences, around the clock status access from almost anywhere and simple administration of Wireless Remote Terminal Unit (WRTUs), preferences, users, reporting parameters and more. Access AlarmAgent.com for real-time report generation capability that is optimized for pump applications. Easily spot clogged or malfunctioning pumps in time to prevent a major problem from getting worse.

FEATURES & BENEFITS

- Totally wireless RTU—easy installation and goes where landlines can't, with 98% availability across North America
- Triple-redundant secure website links WRTU with AlarmAgent.com system
- Customizable user templates and on-demand reporting
- Over-the-air firmware updates allow remote update to WRTUs, no need for a field visit

INCLUDES

24-hour battery backup

SPECIFICATIONS

RADIO TYPE	LTE
NUMBER OF DIGITAL INPUTS	8
NUMBER OF UNIVERSAL INPUTS (UI)	2
NUMBER OF UI CONFIGURABLE ANALOG ALARM INPUTS	2
NUMBER OF UI CONFIGURABLE DIGITAL ALARM INPUTS	2
NUMBER OF DIGITAL OUTPUTS	2
ANTENNA	Phantom, omni-directional, 0 - 3 dB gain
POWER	12V DC
NOTIFICATION METHODS	Email, Pager, Text Message, Voice Call
OPERATING TEMPERATURE RANGE (°F)	-22 to 158
WARRANTY	2 Years



C&M PART #	MFG PART #	ENCLOSURE TYPE	DIMENSIONS (W x H x D)	WEIGHT (lbs)
400165	AA-402ILTE	NEMA -1 Rated, Indoor	4.35" x 9.6" x 2.75"	2.7
400164	AA-402NEMALTE	NEMA -4 Rated, Outdoor	4.33" x 11.5" x 5.5"	5.5

RACO® Catalyst® Interactive Communications System

Get up-to-the-minute, two-way connection with your critical data whether through phone, pager, e-mail or fax channels with the Catalyst Interactive Communications System. It monitors up to 256 points to provide extensive data and event logging capabilities. Featuring up to five megabytes of on-board memory, the system can monitor data samples, alarms, channel state changes and configuration changes.

Obtain the status of level and temperatures indicators, flow meters, switches, annunciator panels, motors, pumps, compressors, PLCs, SCADA systems and other devices at any time. The Catalyst system contacts up to 96 user destinations, communicating the alarm location and status in a voice message or report the condition to a central computer.

The system interfaces with any PLC or with any other device using Modicon's Modbus protocol, using only RS232 communications. The system is easily programmed, even from remote locations, with a free download of RACO Alarmware®. This software allows quick set up of all monitoring, reporting and control functions and features a PIN-based security system.

FEATURES & BENEFITS

- All programming included; configuration and voice messages managed and archived by Alarmware 2.0 software
- Network monitoring supported by a robust set of diagnostics, status and alarm capabilities
- User-recorded alarm and normal messages for each monitored point
- Extensive surge protection
- Built-in speakerphone permits operator to place phone calls and communicate with remote callers



INCLUDES

10-hour battery backup

SPECIFICATIONS

COMMUNICATION METHOD	Landline, Wireless with Cellularm®
NUMBER OF INPUTS	4 Universal Inputs (UI)
NUMBER OF UI CONFIGURABLE FOR DIGITAL ALARM	4
NUMBER OF UI CONFIGURABLE FOR ANALOG ALARM	4
OPERATING TEMPERATURE RANGE (°F)	20 to 130
POWER	12 VDC
DIMENSIONS (W x H x D)	9" x 11-7/8" x 5"
WEIGHT (lbs)	8
NOTIFICATION METHODS	Fax, PA System, Pager, Voice Call
WARRANTY	5 Years Parts and Labor

CERTIFICATIONS

- Complies with UL Standards 1459, 1950

C&M PART #	MFG PART #	TOTAL NUMBER OF CHANNELS MONITORED	ETHERNET/IP	MEMORY (MB)
400176	C10-2-020-1450ET	256	Yes	5

RACO® GUARD-IT® System

The GUARD-IT® system provides flexible features and dependable alarm autodialing and remote monitoring at a low cost. Monitor up to four input channels; configure each channel for an analog or digital signal input. The system utilizes the public telephone network as a basic medium for the transmission of alarm messages and status calls.



Customize and digitally record the station identification and alarm messages. When an alarm condition is detected, the GUARD-IT autodialer automatically calls up to eight preprogrammed phone numbers over the standard dial-up telephone network, calling until it gets acknowledged. The voice transmission consists of a station identification, together with an alarm message giving the details of the fault. Call the system from any remote phone for a status report of all points being monitored.

SPECIFICATIONS

COMMUNICATION METHOD	Landline, Wireless with Cellularm®
NUMBER OF INPUTS	4 Universal Inputs (UI)
NUMBER OF PHONE NUMBERS DIALED	8
OPERATING TEMPERATURE RANGE (°F)	20 to 130
POWER	12 VDC
DIMENSIONS (W x H x D)	8.88" x 6.85" x 2.85"
WEIGHT (lbs)	4, 6 w/ battery
NOTIFICATION METHODS	Pager, Voice Call
WARRANTY	2 Years

C&M PART #	MFG PART #	DESCRIPTION
400184	GI-4	GUARD-IT Autodialer

Klein Tools Multimeters



Digital Multimeters are versatile tools used by electricians and repair technicians to measure various electrical parameters such as AC/DC voltage, current and resistance. It can be used for continuity test, to check for open or short circuits, and general troubleshooting.

Select a multimeter with automatic ranging true root mean square (TRMS) for increased accuracy. All models feature high visibility, reverse contrast display with automatic backlight for viewing even in dimly lit areas. Durable meters withstand a 6.6-ft (2-m) drop.

INCLUDES

110291 - Carrying pouch, test leads, thermocouple with adapter and batteries

110292 - Test leads, batteries and user manual

110293 - Test leads, batteries, thermocouple with adapter and user manual

110294 - Carrying case, test leads, thermocouple with adapter, batteries and user manual

SPECIFICATIONS

C&M PART #	110291	110292	110293	110294
TYPE	Digital Multimeter			
POWER	(2) AAA Battery			
AC VOLTAGE	600 V		1000 V	
DC VOLTAGE	600 V		1000 V	
AC CURRENT	10 A			
DC CURRENT	10 A			
CAPACITANCE	400 μ F	—	400 μ F	6000 μ F
RESISTANCE	50 M Ω	2 M Ω	50 M Ω	60 M Ω
FREQUENCY	—		1 Hz to 50 KHz	1 Hz to 500 KHz
TEMPERATURE	-40 to 1832°F	—	-40 to 1832°F	

C&M PART #	MFG PART #	DESCRIPTION
110291	MM450	TRMS Auto-Ranging; 600 V, Temp
110292	MM325	Manual-Ranging; 600 V
110293	MM420	TRMS Auto-Ranging; 600 V, Temp
110294	MM720	TRMS Auto-Ranging; 1000 V, Temp, Low Impedance

Klein Tools Cordless Utility LED Light Kit

Light up the surrounding work area during with the Utility LED Light. This versatile and portable is great for any worksite. The clamp design fits the corners of utility buckets and locks to straight walls or corners. A second light on the mounting handle illuminates the inside of the bucket to help find tools quickly and easily. Light is designed to fit any DEWALT® 20V battery up to 8.0 Ah.



FEATURES & BENEFITS

- Ergonomic design with one-handed operation
- Rotates 300-degrees horizontally and 180-degrees vertically for maximum exposure
- Sturdy construction to use as a standalone unit
- Flood, spot or flood/spot combination for lighting up to 2500 lumens
- IP54-rated battery compartment withstands dust and water

INCLUDES

(2) 4 Ah batteries and charger

C&M PART #	MFG PART #	TYPE	POWER	AC VOLTAGE
110322	BAT20UBL1	Cordless LED	20V Lithium-Ion	120V

Klein Tools Dual-Laser Infrared Thermometer

The IR10 Dual-Laser Infrared (IR) Thermometer offers a wide measurement range, a tight 20:1 distance-to-spot ratio, dual targeting lasers and several calculation modes to facilitate different temperature measurement applications. In addition to measuring temperature using IR emission, it can also measure temperature using a standard type K probe. *Not a medical device; thermometer is NOT intended for use on people or animals.



FEATURES & BENEFITS

- View max/min/avg/diff readings
- IR accuracy of $\pm 3^{\circ}$ F or ± 1.5 (whichever is greater) for 32° F and above; $\pm (3.6^{\circ}$ F + 0.2 $^{\circ}$ F per degree) for less than 32° F

INCLUDES

Custom pouch, type K probe and battery

C&M PART #	MFG PART #	RESOLUTION	POWER	TEMPERATURE
110318	IR10	0.1 $^{\circ}$ F	(1) 9 V Battery	-40 to 1200 $^{\circ}$ F

Klein Tools Outlet Testers

Use the RT110 Receptacle Tester to detect the most common wiring problems in standard receptacles. Conditions indicated: wiring correct, open ground, reverse electrical outlet, open hot, open neutral, hot/ground reversed. Conditions not indicated: quality of ground, multiple hot wires, combinations of defects, reversal of grounded and grounding conductors.

The RT210 Receptacle Tester is designed to detect the most common wiring problems in standard and GFCI receptacles. A convenient chart on the tester helps determine wiring condition in outlet, based on lights results. Conditions indicated: open ground, reverse polarity, open hot, open neutral, hot/ground reversed.

The RT310 Electrical Tester checks the wiring condition at an electrical outlet and inspects AFCI and GFCI devices. It is designed for use with North American 120 V electrical outlets. It can detect and identify common wiring faults. Includes three 1.5 V AAA alkaline batteries.



C&M PART #	MFG PART #	TYPE	POWER	AC VOLTAGE	FREQUENCY	OPERATING TEMPERATURE
110319	RT110	Receptacle	Plug-in	110/125 V	50/60 Hz	32 to 140°F
110320	RT210	GFCI	Plug-in	110/125 V	50/60 Hz	32 to 140°F
110321	RT310	AFCI/GFCI	Batteries	120 V	N/A	N/A

Klein Tools Digital Circuit Breaker Finder with GFCI Outlet Tester



Quickly and accurately locate the correct circuit breaker in a panel to which an electrical outlet or fixture is connected. The ET310 Circuit Breaker Finder with Integrated GFCI Outlet Tester combines a digital circuit breaker finder and a GFCI outlet tester in one tester set. The transmitter is connected to the electrical outlet or fixture in the circuit while the receiver is used to scan the breakers in the circuit panel. The Transmitter also works as a GFCI outlet tester.

FEATURES & BENEFITS

- Transmitter incorporates a three-pin plug for connecting to North American-style grounded electrical outlets
- Connect transmitter to other electrical fixtures using optional accessories which are sold separately (Cat. No. 69411)

INCLUDES

Includes transmitter, receiver, 9 V battery for receiver and manual

C&M PART #	MFG PART #	AC VOLTAGE	POWER	SAFETY RATING
110317	ET310	90-120V	(1) 9V Battery	CAT II 120V

Klein Tools True RMS Clamp Meters



These Auto-Ranging True RMS Clamp Meters provide excellent accuracy and easy-to-read results to help you get your job done. These meters are built to stand up to tough jobsite conditions and have been designed with specific trades in mind.

INCLUDES

CL320KIT: Convenient carrying pouch, HVAC digital clamp meter, dual IR/probe thermometer, dual range noncontact voltage tester with flashlight, and seven AAA batteries

C&M PART #	MFG PART #	TYPE	RESISTANCE	AC VOLTAGE	DC VOLTAGE	AC CURRENT
110298	CL440	HVAC	60 MΩ	750 V	600 V	600 A
110300	CL320KIT	HVAC	40 MΩ	600 V	600 V	400 A
110299	CL390	AC/DC	40 MΩ	600 V	600 V	400 A
110302	CL360	Current	60 MΩ	600 V	1000 V	200 A
110307	CL800	Current	60 MΩ	1000 V	1000 V	600 A
110303	CL150	AC Current	N/A	N/A	N/A	0.01-3000 A
110305	CL600	AC Current	60 MΩ	1000 V	1000 V	600 A
110306	CL700	AC Current	60 MΩ	1000 V	1000 V	600 A
110304	CL900	Clamp	60 MΩ	1000 V	1000 V	2000 A

Klein Tools Digital Differential Manometer

The ET180 Digital Differential Manometer measures static and differential pressure in air and gas systems. Easily toggle between units: inH₂O, bar, oz/in², psi, mbar, kPa, inHg, mmHg, kg/cm², ftH₂O, and cmH₂O. Automatically zero the before start to ensure accurate measurements. Tapered stainless steel ports accept 1/8 to 5/16" ID flexible tubing. View minimum, maximum and average values on the Large, backlit LCD. Magnet on back for hands-free operation.



FEATURES & BENEFITS

- Large LCD is backlit for easy viewing in low light conditions
- Hold button locks current reading on the display
- Auto-power off feature conserves battery life

INCLUDES

6.56-ft (2-m) long 1/8" (3 mm) ID silicon tubing, (3) AAA batteries, storage pouch and manual

C&M PART #	MFG PART #	ACCURACY	TEMPERATURE	DISPLAY	POWER
110313	ET180	±1.5% Full Scale	32 to 122°	Large LCD	(3) AAA Batteries

Klein Tools Insulation Resistance Tester

The ET600 is a multi-function Megohmmeter capable of producing 125 V, 250 V, 500V, and 1000 V test voltages for insulation resistance measurements up to 4000 MΩ. Test AC/DC voltages up to 1000 V with automatic ranging True RMS technology. Convenient lock function and built-in stand provides hands-free operation. Dual-function backlit LCD displays resistance and voltage.



FEATURES & BENEFITS

- Low battery indicator with easily replaceable battery and fuse
- Backlit display with bar graph, auto-power off, high voltage, max/min, and hold icons
- Warning alarm and high voltage icon for detection of voltage

INCLUDES

CAT III/CAT IV safety rated test leads, heavy-duty alligator clip test leads, six AA batteries, carrying case and manual

C&M PART #	MFG PART #	RESISTANCE	TEMPERATURE	AC/DC VOLTAGE	POWER
110295	ET600	Up to 4000 MΩ	14 to 122°F	1000 V/ 1000 V	(6) AA Batteries

Klein Tools Borescopes



Borescopes are a line of inspection cameras designed to access hard-to-reach areas for visual inspection. These borescopes are equipped with high-quality cameras and flexible cables that allow users to navigate through tight spaces and capture clear images or videos. Select from a wi-fi model or Android® device compatible model to view images on your phone; requires an App download for both models.

C&M PART #	MFG PART #	TYPE	CABLE LENGTH (ft)	DISPLAY	POWER	RESOLUTION
110311	ET20	Wi-Fi	6	External Device	Li-Ion	640 x 480
110312	ET16	Android Devices	10	External Device	Li-Ion	640 x 480

Klein Tools Thermal Imagers



Thermal Imagers are designed to help professionals in various industries, such as electrical, HVAC, and building maintenance, to detect and diagnose issues by visualizing temperature variations. These thermal imagers offer high-resolution images, adjustable emissivity, temperature alarms, and easy-to-use interfaces to help you investigate energy loss, determine hot spots in machinery, and pinpoint clogs in pipes.

INCLUDES

Rechargeable Model: micro-USB charging cable, carrying case and instructions

iOS Model: Hard storage case with carabiner and instructions

Android® Model: USB-C connector, micro-USB connector/adaptor, hard storage case with carabiner and instructions

C&M PART #	MFG PART #	TYPE	RESOLUTION	POWER	FREQUENCY
110308	T1250	Rechargeable	10,800 Pixels	Lithium-Ion	<9 Hz
110309	T1222	iOS Devices	10,800 Pixels	External Device	<9 Hz
110310	T1220	Android Devices	10,800 Pixels	External Device	<9 Hz

Facilities

TABLE OF CONTENTS

Duct Tape	98	Material Handling	138-141
Drum Handling Equipment	98-102	Overhead Lifting	141-153
Ergonomic Solutions	103-107	Barrel Locks	154
Eyewash Stations & Showers	108-113	Padlocks	155-156
Facility Maintenance	114-116	Padlocks - Lockout	156-158
Facility Protection	117	Paints & Painting Supplies	158-162
Fans & Dehumidifiers	118-127	Graffiti Remover	162
Fire Extinguishers	127	Rust Converter	162
Fork Truck Attachments	127-130	Asphalt Patch	163
Grease & Lubricants	131-134	Protective Barriers	163-167
Industrial Ladders, Step Stands & Step Stools	135	Intermediate Bulk Containers	167
Janitorial & Sanitary Supplies	136-137	Hardware Kits	167
Loading Dock Equipment	137-138	Spill Containment	168-169
		Storage Solutions	170-171
		Water Damage Restoration Equipment	171



3M™ Duct Tape



The All-Purpose Duct Tape DT8 offers high instant adhesion coupled with maximum conformability, making it the ideal tape for contoured surfaces. It can be applied in temperatures as low as 40°F and as high as 150°F for up to 30 minutes. The most stretchable 3M duct tape, it bonds to a number of substrates including plastic, glass and sealed concrete and easily tears by hand.

The Multi-Use Duct Tape is equipped with a strong adhesive that lets you quickly patch, bundle and repair so you can move on to your next task. This essential tape is super easy to apply and hand tears lengthwise or crosswise for versatility. Regrip your hammer or seal a package with the reliable strength of this multi-use duct tape.

C&M PART #	MFG PART #	DESCRIPTION	ROLL LENGTH (YD)	ROLL WIDTH
104534	7100158345	All-Purpose Duct Tape DT8	60	1.88"
104533	7100214360	Multi-Use Duct Tape	60	1.88"

Vestil™ Galvanized Steel Buckets

Vestil Galvanized Steel Buckets are perfect for tough industrial and commercial environments where durable equipment is necessary.

FEATURES & BENEFITS

- Nestable for efficient storage
- Carrying handle/bail for easy transport
- 0.4 mm thick galvanized steel construction



C&M PART #	MFG PART #	CAPACITY (GAL)
110664	BKT-GAL-325	3-1/4
110665	BKT-GAL-500	5

Vestil™ Manual Drum Deheader



Convert your closed-head steel drums into storage containers with Vestil Manual Drum Deheader. A simple turn of the adjustment knob allows the deheader to fit steel drums with different thicknesses. The blade, angled for maximum penetration, flattens the cut edge so there are no sharp or jagged edges.

FEATURES & BENEFITS

- Adjustable design works with different types of steel drums
- Heavy-duty construction easily handles steel drums
- Capable of opening 30- and 55-gallon steel drums as well as 5-gallon pails

C&M PART #	MFG PART #	MATERIAL
110747	DD-9	Steel

Vestil™ Vertical Drum Clamp

Use the Vestil Vertical Drum Clamp to easily move and handle open- or closed-head loaded steel, plastic (with lip under drumhead) and fiber drums. Clamp allows for quick, gentle loading into overpacks and keeps drums upright during lift, reducing spills and injuries.



FEATURES & BENEFITS

- Durable construction for added strength and long life

C&M PART #	MFG PART #	MATERIAL	MAX CAPACITY (lbs)
111104	VDC-1000	Steel	1000

AMT® ROTARY DRUM PUMPS

Easily dispense liquids from drums with the AMT Rotary Drum Pumps. For more specifications and Ordering information, check out **page 304**.



Vestil™ Drum Dollies



Designed with durability, functionality, and ease of use in mind, these Vestil Drum Dollies are the perfect solution for effortless and dependable drum transportation. All dollies feature smooth-rolling casters that provide excellent maneuverability. Order the tilting drum dolly that tilts 10 degrees for better liquid extraction.

FEATURES & BENEFITS

- Heavy-duty capacity can handle the heaviest barrels
- Large diameter casters roll smoothly when loaded
- Solid steel construction offers long lasting reliable use

C&M PART #	MFG PART #	DESCRIPTION	CAPACITY (lbs)	DIMENSIONS (L x W x H)	CASTER BRAKES (Y/N)
110967	OCTO-55-CI	Octo Drum Dolly	2000	27-1/16" x 27-1/16" x 7-7/8"	N
110757	DRUM-HD	Heavy Duty Mobile Drum Dolly	2000	24-1/2" x 24-1/2" x 8"	Y
110763	DRUM-SP-28-12-C	Overpack Drum Dolly	1200	28-3/8" x 28-3/8" x 5-5/8"	N
110760	DRUM-QUAD-C-TLT	Multipurpose Tilting Drum Dolly	1200	30-3/4" x 30-3/4" x 6-1/16"	N
110761	DRUM-QUAD-H	Multipurpose Drum Dolly	900	30-7/8" x 30-7/8" x 6-1/4"	N

Vestil™ Chain Drum Lifter

The Vestil Chain Drum Lifter is designed to easily lifting and transport a drum with an overhead lifting device. Use with closed-head steel and plastic 30- and 55-gallon drums with a top lip.

FEATURES & BENEFITS

- Constructed of grade 80 chain for OSHA & ANSI compliance
- Spring-loaded latch for positive drum grip



C&M PART #	MFG PART #	CAPACITY (lbs)	MATERIAL
110713	CDL-2000	2000	Steel

Vestil™ Stackable Steel Drum Rack



Safely increase your storage space with Vestil Stackable Drum Rack. Each rack accommodates two 55-gallon drums and can be stacked up to four racks high to improve vertical storage efficiencies. Note: Do not stack more than four racks high.

FEATURES & BENEFITS

- Four-way fork truck access
- Durable steel construction for strength and longevity

INCLUDES

Bolt together assembly and hardware

C&M PART #	MFG PART #	CAPACITY (lbs)	MATERIAL
110762	DRUM-RACK-2	1,600	Steel

Vestil™ Drum Grippers



Vestil Drum Grippers make it easy to pick up one or two open-head (with lid installed and secured) and closed-head steel drums without leaving the seat of the fork truck. Simply slip the forks into the fork tubes, fasten the safety restraint and the drum gripper is ready to go. The knuckle gripping system is lowered around the drum, gripped tightly and then lifted into the air. The drum is automatically released by lowering the forks.

FEATURES & BENEFITS

- Heavy-duty welded steel construction provides long service life
- Knuckle grip design securely grabs steel drums
- Fold up arms provide convenient storage

INCLUDES

Safety restraint

C&M PART #	MFG PART #	55 GALLON DRUM CAPACITY	TOTAL CAPACITY (lbs)	MATERIAL
110751	DGD-55-D	2	2000	Steel
110752	DGS-55-D	1	1500	Steel

Vestil™ Drum Jack

The Vestil Drum Jack is the perfect solution for any of your drum transporting needs. A unique grapple holds a drum securely into the steel saddle prior to lifting it vertically. A hydraulic pump operated with a push handle raises and lowers the drum with little effort. The drum is held in an upright position during transit, enabling open drums to be handled without spillage.



FEATURES & BENEFITS

- Compact design allows for maximum maneuverability
- Designed to lift and move drums with little energy
- Solid steel construction offers long lasting rugged use

C&M PART #	MFG PART #	CAPACITY (lbs)	MATERIAL
110756	DRUM-55S	660	Steel

Vestil™ Lo-Profile Drum Caddies

Use the Vestil Lo-Profile Drum Caddies to help reduce injuries and the sequential downtime from manually lifting and moving drums. Simply align unit in front of drum, remove handle, grip drum with the handle then tip drum up while guiding the caddy base under the drum. Once the drum is on the caddy, re-attach the handle and transport drum to the desired location. Caddies roll easily on two 6" x 2" rigid wheels and one 3" x 1" swivel caster.



FEATURES & BENEFITS

- High strength steel construction offers long lasting, rugged use
- Removable handle can be used as a drum tool
- Beveled front edge eases the loading of the drum

SPECIFICATIONS

MATERIAL	Steel
CAPACITY (Qty/Type)	One 55 Gallon Drum
DIMENSIONS (L x W x H)	21-5/8" x 31-5/8" x 37-5/8"
INSIDE CRADLE DIAMETER	23-1/2"

C&M PART #	MFG PART #	CASTER TYPE	CAPACITY (lbs)
110943	LO-DC-MR	Rubber	1000
110944	LO-DC-PU	Poly On Steel	1200
110942	LO-DC-CI	Steel	1200

Vestil™ Tilting Drum Ring



Transport your steel drums easily and safely with the Vestil Tilting Drum Ring. To use, slip the band over the belly of the steel drum and tighten the lock to secure the band around the belly of the drum. Two fork openings each measuring 5-1/4"W x 2-7/8"H accept forks to easily lift the drum.

FEATURES & BENEFITS

- Pivoting fork pockets allow for manual rotation of drums to dispense
- Durable construction for added strength and long life

C&M PART #	MFG PART #	CAPACITY (lbs)	MATERIAL
111066	TDR-55	1200	Steel

Vestil™ Deluxe Rotating Drum Cart



Engineered for easy and safe operation, the Vestil Deluxe Rotating Drum Cart makes transporting and rotating heavy steel drums a breeze. Two rigid and two swivel casters offer enhanced maneuverability. Steel stops enable the operator to hold the drum during tipping.

FEATURES & BENEFITS

- Revolving drum cart design rotates drums from vertical to horizontal
- Equipped with rollers for mixing
- Retractable wooden handles for easy operation

INCLUDES

Built-in bung nut wrench

C&M PART #	MFG PART #	CAPACITY (lbs)	MATERIAL
111018	RDC-1000-5PO	1000	Steel

Vestil™ For Truck Drum Carrier/Rotator



The Vestil Fork Truck Drum Carrier/Rotator allows you to easily transport and rotate steel drums using a fork truck. Drums are held securely in place by a durable chain locking system. Use the included chain to easily rotate the drum from the fork truck operator's seat. Drum must be full to rotate at rated capacity.

INCLUDES

Bung nut wrench for opening and closing drums effectively

C&M PART #	MFG PART #	CAPACITY (lbs)	MATERIAL
110745	DCR-205-15	1500	Steel

Vestil™ Portable Drum Lifter/Rotator/Transporter



The Vestil Portable Drum Lifter/Rotator/Transporter makes it easy to lift, transport and tilt drums. Ideal for use in warehouse environments where moving drums to and from racks is common. Lock drums in a vertical position to avoid spills or a horizontal position for draining. The clamp style cradle securely grips the drum ensuring worker safety. For use with steel drums only.

FEATURES & BENEFITS

- Unique design works with 55-gallon drums
- Casters roll smoothly under load
- Manual hand crank tilts the drum up to 120 degrees
- Raise the drum up to 53" using a manual foot or hand pump

C&M PART #	MFG PART #	CAPACITY (lbs)	MATERIAL
110758	DRUM-LRT-EC	550	Steel

FTI EFV Drum Pump Kits

FEATURES & BENEFITS

- Takes up with minimal footprint to conserve space or for use in smaller settings
- Easily transfer high volumes of fluids quickly and effectively to improve productivity
- Durable pumps offer longevity and low maintenance throughout to save you money
- Built-in strainer protects pump



INCLUDES

Motor, drum pump tube, PVDF nozzle, wall mounting bracket and 6-ft ultra-high molecular weight polyethylene hose

SPECIFICATIONS

MOTOR TYPE	115 VAC MOTOR	12 VDC MOTOR	AIR MOTOR
PUMP TUBE MATERIAL	Pure Polypropylene/PVDF		
PUMP TUBE DIAMETER	1-5/16"		
PUMP DISCHARGE HOSE	5-ft, ultra-high molecular weight polyethylene hose		
MAX FLOW RATE (GPM)	17	14	15
MAX DISCHARGE HEAD (ft)	20	13	17
MAX VISCOSITY (cP)	300	100	300
MAX SPECIFIC GRAVITY	1.6		
DISCHARGE SIZE	3/4" Hose Barb		
HOSE SIZE	3/4"		
MOTOR POWER CORD LENGTH (ft)	12	—	—
MOTOR RATING	ODP/Splashproof, IP24		—

Note: All testing performed with water at 68°F, in a full container. Actual performance may vary by +/-10%. Actual performance will decrease with increased fluid viscosity and specific gravity.

CERTIFICATIONS

- 115 VAC Electric motor, QPS; 12 VDC motor, CE

C&M PART #	MFG PART #	TUBE LENGTH	MOTOR TYPE
401276	111621	40"	Two-Speed, 115 VAC, Electric, ODP/IP24
401277	111623	40"	Two-Speed, 12 VDC, Lithium-ion Battery, ODP w/ USA Plug Charger
401278	111625	40"	Two-Speed, 12 VDC, Lithium-ion Battery, ODP w/ 12 V Car Adapter
401279	111626	40"	Variable Speed, Air Motor, Requires 27 cfm @ 40 PSI

REPLACEMENT PARTS & ACCESSORIES

C&M PART #	MFG PART #	REPLACEMENT DRUM PUMP TUBES
401287	DEFV003	EFV40 Drum Pump Only, 40" Tube Length, Pure Polypropylene/PVDF
401288	DEFV010	EFV54 Drum Pump Only, 54" Tube Length, Pure Polypropylene/PVDF

Vestil™ Overhead Drum Lifter

The Vestil Overhead Drum Lifter is designed for lifting drums with an overhead crane or similar lifting device. Included integral fork pockets also allow transporting a drum with forklift. Steel saddle accepts 30- and 55-gallon steel, plastic and fiber drums with a maximum diameter of 24-5/8". Unable to tilt, this lifter is made for straight vertical lifting only.



FEATURES & BENEFITS

- Ratchet strap securely holds the drum in place
- Excellent for vertically lifting steel, plastic and fiber drums
- Yellow, baked-in powder-coating for durability

C&M PART #	MFG PART #	CAPACITY (lbs)	MATERIAL
110759	DRUM-LUG	1000	Steel

Vestil™ Foot Pump Drum Transporter

The Vestil Foot Pump Drum Transporter features a steel jaw that securely grips the top lip of the drum to lift and transport drums. This simple-to-use, economical drum transporter uses a foot pump to lift to raise carriage and elevate the drum.



FEATURES & BENEFITS

- Foot pump lift mechanism
- Push handle folds down for easy access to the foot pump
- Straddle legs rotate for access to drums on pallets

C&M PART #	MFG PART #	CAPACITY (lbs)	MATERIAL
110746	DCR-880-H	1500	Steel

Vestil™ Wall-Mount Cylinder Brackets

These easy-to-install Vestil Wall-Mount Cylinder Brackets hold your cylinders securely in place. Simply bolt to wall and then secure cylinder with strap. Brackets accept cylinders up to 12" in diameter. Installation hardware is not included.



FEATURES & BENEFITS

- Edges protected by rubber guards
- Lightweight design eases handling
- Steel construction offers durability

C&M PART #	MFG PART #	MAX NUMBER OF CYLINDERS HELD
110712	CB-W-S	1
110710	CB-W-2S	2
110711	CB-W-3S	3

Vestil™ Fire Extinguisher Carrier

Use the Vestil Fire Extinguisher Carrier to easily transport your fire extinguisher. The carrier accepts fire extinguishers up to 8" in diameter and feature a 4" x 2" stabilizing plate that keeps extinguisher upright when empty.



FEATURES & BENEFITS

- Handle with rubber grip and poly-on-poly casters for tilt and go portability
- Baked-in powder coating for durability

INCLUDES

Two heavy-duty adjustable EPDM rubber straps and wall mount bracket

C&M PART #	MFG PART #	CAPACITY (lbs)	MATERIAL
110788	FEC-1	100	Steel

Vestil™ Pail Lid Closing Tool

Quickly and easily secure a steel pail lid onto a 5-gallon steel pail with the Vestil Steel Pail Lid Closing Tool. In a single motion the tool manually crimps and closes 16 lugs to create a tight seal. Long handles provide leverage reducing the required effort to secure lids to pails. Intended for use with non-UN Vestil steel lids and steel pails.



C&M PART #	MFG PART #	PAIL SIZE (GAL)	MATERIAL
110978	PLC-5	5	Steel

Vestil™ Welding Cylinder Torch Carts

The Vestil Welding Cylinder Torch Cart is designed for transporting cylinders and a cutting torch. These two-tank capacity carts come with heavy-duty ratchet straps to hold cylinders securely in place. An included bracket holds a cutting torch and hose for your convenience. Note: Not designed for storing gas cylinders.



FEATURES & BENEFITS

- Sturdy handles and large wheels for tilt and go portability
- Overhead lift eye and fork pockets for easy transportation
- Lockable storage box to store regulators
- Welded steel construction with painted finish offer excellent durability

C&M PART #	MFG PART #	WHEEL TYPE	CAPACITY (lbs)	CAPACITY (# OF CYLINDERS)	MATERIAL
110722	CYL-2	Pneumatic	500	2	Steel
110723	CYL-2-FF	Foam Filled	500	2	Steel



Vestil™ Elevating Lift Carts

Use the Elevating Lift Carts to protect employees from lifting injuries while simultaneously increasing productivity, reducing fatigue and improving overall performance. These durable steel elevating lift carts are well suited for manufacturing, distribution and water/wastewater treatment plant environments.

Easily load materials onto a cart from a table, lower to safe transporting height and raise to unload at the destination. The foot pump includes a soft-lowering down valve for precise positioning and the perfect ergonomic height. Each cart comes with four polyurethane casters; two swivel with brakes and two are rigid. Choose from several elevating lift carts to find your perfect solution.

Hydraulic Elevating Carts can raise and lower the platform with a single-speed or two-speed foot pump.

Air Hydraulic Carts utilize the two-speed foot pump for minor height adjustments and the factory air/oil power for effortless lifting.

DC Powered Hydraulic Lifting Cart is ideal for quick lifting and ergonomic material handling. Battery-powered units allow operators to raise and lower the platform with the push of a button. Includes one 12V battery and an on-board charger.

Mechanical Scissor Cart raises and lowers material quickly and easily. The centrally located hand crank allows the user to raise and lower the platform to an exact height that best fits the users' needs.

FEATURES & BENEFITS

- Improves user safety and productivity
- Caster construction provides smooth and easy transport when loaded
- Steel construction offers long lasting rugged use



110704

110705

110707



110708

110701



110702

110703



110643

110644



110706

110700

C&M PART #	MFG PART #	CAPACITY (lbs)	SERVICE RANGE	PLATFORM SIZE (W x L)	SCISSOR TYPE
HYDRAULIC ELEVATING CARTS					
110704	CART-200-D	220	10" to 51"	17-1/2" x 27-1/2"	Double
110705	CART-400	400	8-3/4" to 29"	17-1/2" x 27-1/2"	Single
110707	CART-750-TS	750	15-1/2" to 35-1/2"	19-3/4" x 32"	Single
110708	CART-800-D-TS	800	15-1/2" to 51-7/8"	20" x 35-1/2"	Double
110701	CART-1000-LD	1000	15" to 36"	31-1/2" x 63"	Single
110702	CART-1000-TS	1000	15-1/2" to 35-1/2"	19-3/4" x 32"	Single
110703	CART-1500-D-TS	1500	19" to 68"	24" x 47-1/2"	Double
AIR HYDRAULIC CARTS					
110643	AIR-1500-D	1500	19-1/2" to 67"	24" x 47-1/2"	Single
110644	AIR-2000	2000	15" to 39-1/2"	24" x 47-1/4"	Single
DC POWERED HYDRAULIC ELEVATING CART					
110700	CART-1000D-DC	1000	19-1/2" to 63-3/4"	20-1/2" x 39-3/4"	Double
MECHANICAL SCISSOR CART					
110706	CART-660-M	660	18" to 39-1/2"	23-1/2" x 37"	Single



Vestil™ Plastic Floor Grid



Keep your work area comfortable, injury free and productive with the Plastic Floor Grid. The grids snap together easily to help create an anti-fatigue work area. Alternatively, the grid can be used to store products elevated above cold and damp floors.

FEATURES & BENEFITS

- Easy to attach—simply snap together, no hardware necessary
- Abrasion-resistant “GRID” sections are ideal for wet floors such as paint booths, car washes or general work areas
- Lightweight units are only 2 lbs per section
- Sold 15 per box

C&M PART #	MFG PART #	DIMENSIONS (L x W x H)	CAPACITY (lbs)	QTY/BOX
110789	F-GRID	23-1/2" x 11-3/4" x 1"	1100	15

Vestil™ Manual Hydraulic Fork Truck Jack



Ideal for performing safe and easy maintenance on a fork truck, the Manual Hydraulic Fork Truck Jack is a must for work environments that employ fork trucks. Designed to raise your fork truck a maximum of 16", you will have plenty of room to perform a variety of repairs and preventative maintenance, improving reliability of your equipment and therefore productivity.

FEATURES & BENEFITS

- High-quality seals, chrome plated internal components and rugged steel construction
- Manually raised by hand pump lever
- Removable handle and compact size makes it easy to maneuver and transport

INCLUDES

Two jack stands (13-ton capacity per pair), with holding pins for adjustable heights

C&M PART #	MFG PART #	CAPACITY (lbs)
110812	FORK-J	8000

Vestil™ Non-Adjustable Pallet Jockey



The Non-Adjustable Pallet Jockey is a simple device that allows drivers and warehouse personnel to unload sideways pallets efficiently and safely with their walkie pallet trucks. This unit is ideal for warehouse distribution centers that use one particular electric pallet truck model. To use, simply place the pallet jockey hooks into the fork wheel openings. Fits most popular sizes of walkie truck.

C&M PART #	MFG PART #	CAPACITY (lbs)	HOOK WIDTH	HOOKS DISTANCE INSIDE EDGE TO INSIDE EDGE
110977	PJ-1005	4000	3"	15-1/8"

Vestil™ Gravity Roller Conveyors



Minimize worker fatigue and improve productivity with Gravity Roller Conveyors. Place conveyors on the floor next to your workstations or use them in your dock area. Roller conveyors help minimize lifting and carrying, reducing the risk of injury.

FEATURES & BENEFITS

- Minimize reliance on carrying or a fork truck
- Zinc plated steel frame resists corrosion & includes spring loaded rollers set low in the frame
- Couplers included to join multiple units together
- Ships assembled

SPECIFICATIONS

CAPACITY (lbs)	5000
ROLLERS (QTY)	15
ZINC PLATED STEEL GAUGE	10
SPRING LOADED ROLLER GAUGE	13
ROLLER DIAMETER	2-3/8"
ROLLER CENTER	3-15/16"
USABLE WIDTH	50"

C&M PART #	MFG PART #	DESCRIPTION
110717	CONV-52-5-2-3L-Z	Gravity Roller Conveyor, 52" x 60"

Vestil™ Load Lifters

These Load Lifters help keep work environments that require a lot of lifting injury free and productive. Each load lifter have several different features to specializes in a certain work environment. Read below or call us to learn more about each Load Lifter to find the right lifter for your job.

Hand Winch Lift Trucks are designed for lifting material to and from shelves, moving office equipment and installing ceiling/wall appliances. The lift is operated by a hand-crank winch with a reversible handle and a hold-down device for securing the carriage during transport. Forks rise 1" per complete hand crank rotation. The fixed (non-adjustable) forks can be inverted to provide different height ranges. Models ending in 'HP' and 'EHP' have extended height capabilities. These units have a 2-stage mast system and a telescoping inner mast frame to extend the forks above the height of the first mast.

Lite Load Lifts are designed for lifting material from delivery trucks to docks or to inventory storage systems. Easily operate with either a hand winch or foot pump. The platform lifts approximately 1" per winch rotation or foot pump stroke. Handle has two rollers for easy loading into delivery trucks.

Heft-Lifts provide reliable, powerful lifting while moving and positioning loads. The manual hydraulic foot pump yields 3/4" of platform travel per stroke. Units roll smoothly on two rigid and two swivel poly-on-steel casters with foot operated brake. Heft-Lifts provide unquestionable durability with welded steel construction and chrome platforms and uprights. Not for use with pallets but skids are acceptable.

Portable Aluminum Load Lifter is a durable and lightweight lifter constructed of corrosion-resistant aluminum. Use it to load and unload pallet racking and to move heavy parts—ideal in shipping and receiving areas. This unit folds up and down for compact storage and easy transportation. Ultra low-profile design with ramp is great for tight storage spaces.



C&M PART #	MFG PART #	CAPACITY (lbs)	SERVICE RANGE	STRADDLE	MATERIAL
HAND WINCH LIFT TRUCKS					
110648	A-LIFT-S	500	1-1/4" to 47-1/4"	Adjustable	Aluminum/Steel
110646	A-LIFT-R	500	3-1/2" to 47"	Fixed	Aluminum/Steel
110649	A-LIFT-S-EHP	350	1-1/4" to 122"	Adjustable	Aluminum/Steel
110647	A-LIFT-R-HP	400	3-1/2" to 97"	Fixed	Aluminum/Steel
110650	A-LIFT-S-HP	400	1-1/4" to 98-7/16"	Adjustable	Aluminum/Steel
LITE LOAD LIFTS					
110654	ALLW-2020-FW	400	3-1/8" to 58"	—	Aluminum/Steel
110935	LLW-202058-FW	400	3-1/8" to 58"	—	Steel
HEFTI-LIFTS					
110922	HYD-5	880	4-1/2" to 44"	—	Steel
110921	HYD-10	880	4-1/2" to 59"	—	Steel
PORTABLE ALUMINUM LOAD LIFTER					
110968	PALL-200	200	0" to 61"	—	Aluminum

Vestil™ Hydraulic Post Tables

These Hydraulic Post Tables are ideal for any number of material handling facilities. Whether you are boxing products for shipment, lifting dies or castings or moving heavy boxes, the hydraulic post tables will help you get the job done. Easily maneuver these smooth rolling tables using two locking swivel casters with brakes and two rigid casters. Lift or lower tables to your exact height using a foot pump.

FEATURES & BENEFITS

- Heavy-duty steel construction is ideal for industrial work areas
- Telescopic posts stabilize loads during use
- Patented ergonomic push handle makes pushing the unit safe and easy



C&M PART #	MFG PART #	PLATFORM SIZE	SERVICE RANGE	FOOT PUMP OPERATION	CAPACITY (lbs)	NUMBER OF POSTS
110917	HT-02-1616A	16" x 16"	31" to 49"	1-speed	200	0
110918	HT-05-1818A	18" x 18"	31" to 49"	1-speed	500	2
110919	HT-10-2036A	20" x 36"	36" to 54"	2-speed	1000	2
110920	HT-20-2436A	24" x 36"	36" to 54"	2-speed	2000	4

Vestil™ Deluxe Roller Stands



The Deluxe Roller Stands offer you an extra hand when working with long materials. The height of the stand is adjusted with a friction lock screw. Great for use in machine and wood shops.

FEATURES & BENEFITS

- Easy height adjusts for different leveled machines
- Lightweight construction makes moving from one machine to another easy
- 2" chrome plated rollers and heavy-duty cast steel base

C&M PART #	MFG PART #	DESCRIPTION	CAPACITY (lbs)	SERVICE RANGE	ROLLER LENGTH
111056	STAND-H	Steel Horizontal Roller Stand	1760	23" to 38-1/2"	14"
111057	STAND-H-HP	Steel Horizontal Roller Stand	1760	27" to 42"	14"
111058	STAND-V-HP	Steel V-Beam Roller Stands	1760	27" to 42"	2 x 5"

Vestil™ Tilt Masters

With the newly designed heavy-duty Tilt Masters there is no need for a fork truck or lift table to lift and position filled tote boxes or baskets. These 90 degree tilters will function as a transporter by moving completed products from work station to work station without waiting for a for truck. Use the TM series (111094) with open bottom pallets or skids only; use the TMS, or Tilt Master Straddle series (111095), with virtually any kind of container or pallet.

FEATURES & BENEFITS

- Tilts products from ground level to a comfortable operator working height
- Ergonomic handle for comfort and quick and easy maneuverability
- Thin profile allows the user to get as close to the load as possible

INCLUDES

12V battery, push-button hand control, on-board charger and battery charge indicator gauge

Vestil™ Manual Hand Winch Stacker

This Manual Stacker with adjustable forks is ideal for use in a variety of workplace applications that require moving and/or stacking pallets or skids. Lift and lower by hand winch and steel cable mechanism. Each handle revolution provides 3/4" of lift for precise positioning. Easily maneuver using two rigid and two swivel wheels with brakes.



FEATURES & BENEFITS

- Full-height push handle for easy steering and excellent visibility through welded mesh guard
- Heavy-duty mast and a unique winch design for easier and safer lifting
- Maintenance free and easy to use

SPECIFICATIONS

CAPACITY (lbs)	2000
INDIVIDUAL FORK WIDTH	3-15/16"
FORK LENGTH	42-1/8"
SERVICE RANGE	2" to 63"
FORK ADJUSTMENT MINIMUM (O.D.)	7-7/8"
FORK ADJUSTMENT MAXIMUM (O.D.)	26-3/4"

C&M PART #	MFG PART #	DESCRIPTION
111145	VHPS-2000-AA	Manual Hand Winch Stacker



SPECIFICATIONS

CAPACITY (lbs)	2000
MAXIMUM TILT DEGREE	90
POWER	12VDC

C&M PART #	MFG PART #	DESCRIPTION	LOWERED HEIGHT	ROTATED HEIGHT	OPERATOR REACH	FORK TYPE
111094	TM-20-DC	Tilt Master	3-5/8"	33"	7-1/4"	Fixed
111095	TMS-20-DC	Tilt Master Straddle	3"	37"	13-1/2"	Adjustable

Vestil™ Tote Lifters



Easily lift open bottom skids, boxes and baskets using these Tote Lifters. Solid steel construction provides long lasting rugged use. Automatic stabilizers engage when forks reach specific height to prevent unit from moving. Two operations are available: hand pump (110926) and DC power with rocker switch to raise and lower (110925) for forks. Hand pump design features an ergonomic pump handle with two lifting speeds to accommodate light or heavy loads. DC power unit includes one 12V battery and on-board battery charger.

SPECIFICATIONS

CAPACITY (lbs)	3000
SIDE STABILIZER LOCKS AT RAISED HEIGHT	20-1/2"
RAISED HEIGHT	31-1/2"
LOWERED HEIGHT	3-1/2"
MATERIAL	Steel

C&M PART #	MFG PART #	DESCRIPTION	FORK DIMENSIONS
110926	L-270-HD	Hand Pump Tote Lifter	43"L x 26-3/4"W
110925	L-270-DC-HD	DC Powered Tote Lifter	45"L x 27"W

Vestil™ Ergonomic Worker Seats

These Ergonomic Worker Seats help reduce fatigue as well as minimize health issues created by prolonged sitting in uncomfortable chairs. Sturdy steel construction is durable enough for just about any industrial environment.



The CPRO-600 (110718) model is adjustable in 2" increments from a low crouch to a standing position with the simple cross bar attachment design. The units are constructed with four rubber "shocks" under the seat base which allows the seat to tilt forward, left and right so it can accommodate our body movements and a more natural posture position.

The CPRO-800LP (110719) model is not only convenient but easy to use. Simply unfold the rear legs and slide the contoured padded seat to the desired ergonomic height using the infinite adjustment system for optimum work posture. Folds up to a 4" profile for easy portability and storage.

C&M PART #	MFG PART #	SEAT HEIGHT RANGE	CAPACITY (lbs)	SEAT MATERIAL
110718	CPRO-600	13" to 34"	220	Padded
110719	CPRO-800LP	18-1/2" to 33"	220	Padded

STAY IN TOUCH



FIND US ON

Facebook, LinkedIn,
Instagram, Twitter (X), YouTube

Vestil™ Ergonomic Worker Stool

This high-quality, durable Ergonomic Worker Stool is ideal for production lines, workstations, repair work and industrial/commercial environments. The stool has a pneumatic seat height adjustment and an easy-to-clean soft-foamed polyurethane seat.



FEATURES & BENEFITS

- Pneumatic seat height adjustment
- Five-foot pad base design with casters
- Easy to clean

C&M PART #	MFG PART #	SEAT DIAMETER	CAPACITY
111155	WLPS-2	13-1/2"	300

Guardian Heated Portable Eyewash/Drench Hose Unit

This electrically heated and insulated Portable Eyewash/Drench Hose Unit helps you stay ANSI Z358.1-2014 compliant in areas where ambient temperatures may drop below the tepid range (60 to 100°F). In extreme conditions, the heating system will also protect the unit against freezing. The silicone drum heater's thermostat is set to 65°F and automatically turns the heater on and off to maintain the temperature.

Use the spray head and drench hose combination to effectively rinse eyes, face and body. The maneuverable 42-lb unit uses air pressure to deliver 10 gallons of water at 0.7 gallons/min for 15 minutes. Heater requires 120 VAC, 15 amp power source and has a 9-ft long cord with GFCI plug and manual reset.



FEATURES & BENEFITS

- Two GS-Plus™ low flow spray heads with “flip top” dust covers and integral flow controls
- Filters remove impurities from the water flow
- High visibility orange insulated nylon jacket contains heat, is waterproof and resistant to mildew
- Unit is assembled and factory tested before shipment

INCLUDES

ANSI-compliant identification sign and inspection tag, bacteriostatic additive and 9-ft power cord with GFCI plug

SPECIFICATIONS

TANK MATERIAL	Stainless Steel
INTERNAL BALL VALVE MATERIAL	Chrome Plated Brass
SPRAY HEAD MATERIAL	Polypropylene

C&M PART #	MFG PART #	CAPACITY (GAL)
400211	G1562HTR	15

Radians Eyewash Stations



Compact and easy to mount, these personal eyewash stations are perfect for immediate flushing of eyes in an emergency, until the injured person can be helped to a proper eyewash station.

FEATURES & BENEFITS

- Conveniently mounts to wall for easy access
- Bright green color makes eyewash easy to locate in an emergency
- Easily removable bottle snaps securely in place
- Bottles dated for freshness

C&M PART #	MFG PART #	DESCRIPTION
100082	REW16S	Eyewash Station, Single, 16 oz
100084	REW32S	Eyewash Station, Single, 32 oz
100083	REW16D	Eyewash Station, Double, 16 oz
100081	REW32D	Eyewash Station, Double, 32 oz

Honeywell® Sterile Eyesaline® Eyewash Bottles

Place personal eyewash bottles closer to contaminants so immediate treatment can be provided in case of an accident. While not intended to replace the primary eyewash equipment, these bottles are an important supplement for the injured worker before accessing the primary eyewash equipment. They are also great for using while the injured worker is being transported to medical care.



FEATURES & BENEFITS

- Extended-flow nozzles provides longer flow than conventional eyewash containers
- Buffered, sterile saline solution is superior to tap water for emergency eye care
- Tamper-resistant blow-fill-seal can be easily removed in an emergency

INCLUDES

12 bottles

C&M PART #	MFG PART #	DESCRIPTION
111174	203-32-000454-0000-H5	Portable Sterile Eyewash Bottle, 16 oz
111175	203-32-000455-0000-H5	Portable Sterile Eyewash Bottle, 32 oz

Guardian Portable Eyewash/Drench Hose Unit

This Portable Eyewash Station is ideal for keeping low-hazard worksites OSHA and ANSI Z358.1-2014 compliant when a continuous supply of water is not available. The maneuverable 35-lb (116 lbs filled) unit uses air pressure to deliver 10 gallons of water at 0.7 gallons/min for 15 minutes. Spray head and drench hose combination allows for the effective rinsing of eyes, face and body.

FEATURES & BENEFITS

- Perfect portable eyewash station for low-hazard worksites
- Two GS-Plus™ low-flow spray heads with “flip top” dust covers and integral flow controls
- Filters remove impurities from the water flow
- User’s hands are free while eyewash is in operation
- Unit is assembled and factory tested before shipment

INCLUDES

ANSI-compliant identification sign, inspection tag and bacteriostatic additive

SPECIFICATIONS

TANK MATERIAL	Stainless Steel
INTERNAL BALL VALVE MATERIAL	Chrome Plated Brass
SPRAY HEAD MATERIAL	Polypropylene

C&M PART #	MFG PART #	CAPACITY (GAL)
400210	G1562	15



Guardian Combination Safety Stations

Quickly wash away contaminants on the body or eyes with the Guardian Combination Safety Station. The combination safety stations include both a safety shower and eyewash station and are ANSI Z358.1-2014 compliant. Shower head has internal 20 GPM flow control and eye/face wash has internal 1.6 GPM flow control per spray head. Select PVC unit (400213) for use in industrial environments where harsh acids or caustics are present; stainless steel unit (400212) is ideal for corrosive and cleanroom environments.

FEATURES & BENEFITS

- Two GS-Plus™ low flow eyewash spray heads with “flip top” dust covers and integral flow controls
- Filters remove impurities from the water flow
- Valve and spray head assemblies are factory assembled and water tested prior to shipment
- 2-year warranty

INCLUDES

ANSI-compliant identification sign

SPECIFICATIONS

SHOWER HEAD DIAMETER	10"
SPRAY HEAD MATERIAL	Polypropylene
SUPPLY INLET TYPE	1-1/4" NPT(F)
WASTE OUTLET TYPE	1-1/4" NPT(F)



C&M PART #	MFG PART #	VALVE MATERIAL	SHOWER HEAD MATERIAL	BOWL DIAMETER	BOWL MATERIAL	PIPE & FITTINGS MATERIAL
400191	G1902	Chrome plated brass	ABS Plastic	11-1/8"	SS	Schedule 40 galvanized steel w/ orange PE pipe cover
400192	G1902P	Chrome plated brass	ABS Plastic	11-3/4"	ABS Plastic	Schedule 40 galvanized steel w/ orange PE pipe cover
400193	G1902BC	Chrome plated brass	ABS Plastic	11-1/2"	SS with Cover	Schedule 40 galvanized steel w/ orange PE pipe cover
400213	G1990	316 SS	ABS Plastic	11-3/4"	ABS Plastic	Schedule 80 PVC
400212	G1991	316 SS	SS	11-1/8"	SS	Schedule 40 Type 304 brushed SS with orange PE pipe cover

SS: stainless steel; PE: polyethylene

REPLACEMENT PARTS & ACCESSORIES

C&M PART #	MFG PART #	DESCRIPTION
400197	G6020	Thermostatic Mixing Valve, 13 Gallon Capacity
400198	G6040	Thermostatic Mixing Valve, 50 Gallon Capacity
400205	AP275-705	Strobe Light and Alarm Horn w/ Weatherproof Remote Sensing Flow Switch
400206	AP275-705N4X	Strobe Light and Alarm Horn, NEMA-4X Rated Components
400207	AP275-705CID2	Strobe Light and Alarm Horn, CID2 Rated Components



Guardian Pedestal Mounted Eyewash Stations



Free standing Pedestal Mounted Eyewash Stations are perfect for areas where an eyewash and shower combination unit is not necessary. These easy-to-use eyewash stations help ensure worker safety and stay compliant.

FEATURES & BENEFITS

- Two GS-Plus™ low flow spray heads with “flip top” dust covers and integral flow controls
- Filters remove impurities from the water flow
- Furnished with orange pipe covers for high visibility and corrosion resistance
- Stay open ball valve allows for hands-free operation
- Valve, bowl and spray head assembly is factory assembled and water tested prior to shipment

INCLUDES

ANSI-compliant identification sign and inspection tag

SPECIFICATIONS

SPRAY HEAD MATERIAL	Polypropylene
VALVE MATERIAL	Chrome Plated Brass
PIPE & FITTINGS MATERIAL	Schedule 40 Galvanized Steel
SUPPLY INLET	1/2" NPT(F)
WASTE OUTLET	1-1/4" NPT(F)

C&M PART #	MFG PART #	BOWL TYPE	BOWL DIAMETER
400188	G1825	Stainless Steel	11-1/8"
400189	G1825P	ABS Plastic	11-3/4"
400190	G1825BC	Stainless Steel w/ Cover	11-1/2"

REPLACEMENT PARTS & ACCESSORIES

C&M PART #	MFG PART #	DESCRIPTION
400197	G6020	Thermostatic Mixing Valve, 13 Gallon Capacity
400198	G6040	Thermostatic Mixing Valve, 50 Gallon Capacity

Guardian Wall-Mounted Eyewash Stations



The Wall-Mounted Eyewash Stations conveniently set up out of the way while remaining easily accessible in case of an emergency. These stations are perfect for areas where an eyewash and shower combination unit is not necessary. Heavy-duty cast aluminum wall bracket with corrosion-resistant powder-coat finish makes mounting simple.

FEATURES & BENEFITS

- Two GS-Plus™ low flow spray heads with “flip top” dust covers and integral flow controls
- Filters remove impurities from the water flow
- Stay open ball valve allows for hands-free operation
- Unit is completely assembled and tested prior to shipment

INCLUDES

ANSI-compliant identification sign, inspection tag and wall bracket

SPECIFICATIONS

SPRAY HEAD MATERIAL	Polypropylene
VALVE MATERIAL	Chrome Plated Brass
SUPPLY INLET	1/2" NPT(F)
WASTE OUTLET	1-1/4" NPT(F)

C&M PART #	MFG PART #	BOWL TYPE	BOWL DIAMETER
400185	G1814	Stainless Steel	11-1/8"
400186	G1814P	ABS Plastic	11-3/4"
400187	G1814BC	Stainless Steel w/ Cover	11-1/2"

REPLACEMENT PARTS & ACCESSORIES

C&M PART #	MFG PART #	DESCRIPTION
400197	G6020	Thermostatic Mixing Valve, 13 Gallon Capacity
400198	G6040	Thermostatic Mixing Valve, 50 Gallon Capacity



Helpful Tip: Location of Emergency Equipment

The ANSI Z358.1-2014 "Emergency Eyewash and Shower Equipment" standard provides that emergency equipment must be able to deliver 3 gpm of water for 15 minutes and be installed within 10 seconds walking time from the location of a hazard (this comes to approximately 55 feet). The equipment must be installed on the

same level as the hazard (no need to go up or down stairs or ramps) and the path of travel from the hazard to emergency equipment should be free of obstructions and as straight as possible. It is important that you ensure your work environment complies with all applicable standards, regulations and laws.

Guardian Eyewash/Drench Hose Units



These dual-purpose Eyewash/Drench Hose Units meet the provisions of ANSI Z358.1-2014 as both an eyewash and a drench hose. Locking clip engages when handle is depressed, providing “hands free” operation. Valve stays open until locking ring is released. Alternatively, unit may be removed for use as a drench hose to rinse any part of the user’s eyes, face or body.

FEATURES & BENEFITS

- Two GS-Plus™ low flow spray heads with “flip top” dust covers and integral flow controls
- Filters remove impurities from the water flow
- Units are completely assembled and water tested prior to shipment

INCLUDES

All units include ANSI-compliant identification sign; Deck unit comes with deck flange for mounting; wall unit comes with a bracket with spring clips for mounting

SPECIFICATIONS

SPRAY HEAD MATERIAL	Polypropylene
VALVE MATERIAL	Forged Brass
SUPPLY INLET	3/8" NPT(M)
HOSE TYPE	8-ft L Reinforced PVC, 275 PSI (Max Working)

C&M PART #	MFG PART #	DESCRIPTION
400208	G5022	Deck-Mounted Unit
400209	G5026	Wall-Mounted Unit

REPLACEMENT PARTS & ACCESSORIES

C&M PART #	MFG PART #	DESCRIPTION
400197	G6020	Thermostatic Mixing Valve, 13 Gallon Capacity
400198	G6040	Thermostatic Mixing Valve, 50 Gallon Capacity

Guardian Heat-Traced Combination Safety Stations

The Guardian Heat-Traced Safety Station with an eyewash, shower and top inlet are heated to prevent freezing in cold temperatures. Thermostat-regulated units are heated by a self-limiting heat-tracing cable wrapped around the internal pipe to prevent freezing even at -40°F. Unit is fully wired at the factory and requires 120 VAC single phase power supply. Shower head is 10" ABS plastic with internal 20 GPM flow control; freeze-resistant eyewash spray head assembly comes with float-off dust covers and internal flow control.



FEATURES & BENEFITS

- Ideal for use in areas emergency stations need protection from freezing
- ‘Tempering valves’ section to ensure tepid water compliance with ANSI Z358.1-2014
- Shower and eyewash valves are US-made with brass ball and PTFE seals
- Jacket/insulation is UV-resistant orange ABS plastic with polyethylene foam insulation

INCLUDES

ANSI-compliant identification sign

SPECIFICATIONS

SHOWER HEAD DIAMETER	10"
SPRAY HEAD MATERIAL	Chrome Plated Brass
SUPPLY INLET TYPE	1-1/4" NPT(F) Top Inlet
VALVE MATERIAL	Brass
PIPE & FITTINGS MATERIAL	Schedule 40 Galvanized Steel

CERTIFICATIONS

- FM, UL and CSA approved for Class I, Division 2, Groups B, C and D

C&M PART #	MFG PART #	ALARM OPTION INCLUDED
400199	GFR3100	None
400200	GFR3107	Alarm horn, light and remote sensing

REPLACEMENT PARTS & ACCESSORIES

C&M PART #	MFG PART #	DESCRIPTION
400197	G6020	Thermostatic Mixing Valve, 13 Gallon Capacity
400198	G6040	Thermostatic Mixing Valve, 50 Gallon Capacity
400205	AP275-705	Strobe Light and Alarm Horn w/ Weatherproof Remote Sensing Flow Switch
400206	AP275-705N4X	Strobe Light and Alarm Horn, NEMA-4X Rated Components
400207	AP275-705CID2	Strobe Light and Alarm Horn, CID2 Rated Components

Guardian Freeze & Scald Resistant Combination Safety Stations

Guardian combination safety stations can be outfitted to keep you and your team safe in extreme work environments, as well as keep your work site ANSI Z358.1-2014 compliant. The dangerous issue of freezing and scalding water in a safety station are no problem for the following Guardian combination safety stations.

The Guardian **Freeze-Resistant Safety Station** (400201) has its freeze-resistant valves and supply lines buried below the frost line to protect against freezing. Unit is designed to drain completely after use, so that no standing water remains in unit and possibility of freeze-up is eliminated. Since unit is intended for use in cold weather conditions, consideration should be given to supplying unit with tempered water in accordance with ANSI Z358.1-2014. See part numbers 400197 and 400198 for more information on Guardian thermostatic mixing valves.

The Guardian **Freeze Protection Safety Station** (400194) features a temperature-actuated freeze protection valve. When the water temperature drops below 40°F, the valve automatically opens to allow water to circulate through the unit, preventing water from freezing. The unit is designed so that when the drain valve is open, there are no “dead legs” of water standing in the unit. Water flow stops when the water temperature rises above 40°F.

The Guardian **Scald Protection Safety Station** (400196) is furnished with a temperature-actuated scald protection valve. When water temperature rises above 95°F, valve automatically opens to allow water to circulate through unit, preventing injury to user. Unit is designed so that when drain valve is open, there are no “dead legs” of water standing in unit. Water flow stops when temperature falls below 95°F.

The Guardian **Freeze/Scald Protection Safety Station** (400195) includes temperature-actuated freeze and scald protection valves. When the water temperature drops below 40°F or rises above 95°F, the drain valve automatically opens to allow water to circulate through the unit. The unit is designed so that, when the drain valve is open, there are no “dead legs” of water standing in unit. Water circulates until water temperatures returns to within the 40°F and 95°F range.

FEATURES & BENEFITS

- Two GS-Plus™ low flow eyewash spray heads with “flip top” dust covers and integral flow controls
- Filters remove impurities from the water flow
- Valve and spray assemblies are factory assembled and water tested prior to shipment
- 2-year warranty

INCLUDES

ANSI-compliant identification sign



SPECIFICATIONS

SHOWER HEAD DIAMETER	10"
SHOWER HEAD MATERIAL	ABS Plastic
EYEWASH BOWL DIAMETER	11-1/8"
EYEWASH BOWL MATERIAL	Stainless Steel
SPRAY HEAD MATERIAL	Polypropylene
PIPE & FITTINGS MATERIAL	Schedule 40 Galvanized Steel w/ Orange Polyethylene Pipe Cover
WASTE OUTLET	1-1/4" NPT(F)

C&M PART #	MFG PART #	DESCRIPTION	VALVE MATERIAL	SUPPLY INLET(S)
400201	GFR1902	Freeze-Resistant Safety Station	Brass	Eyewash Valve: 3/4" NPT(F); Shower Valve: 1-1/4" NPT(M)
400194	G1941	Freeze Protection Safety Station	US-Made Chrome Plated Brass	1-1/4" NPT(F) Top Inlet
400196	G1943	Scald Protection Safety Station	US-Made Chrome Plated Brass	1-1/4" NPT(F) Top Inlet
400195	G1942	Freeze/Scald Protection Safety Station	US-Made Chrome Plated Brass	1-1/4" NPT(F) Top Inlet

REPLACEMENT PARTS & ACCESSORIES

C&M PART #	MFG PART #	DESCRIPTION
400197	G6020	Thermostatic Mixing Valve, 13 Gallon Capacity
400198	G6040	Thermostatic Mixing Valve, 50 Gallon Capacity
400205	AP275-705	Strobe Light and Alarm Horn w/ Weatherproof Remote Sensing Flow Switch
400206	AP275-705N4X	Strobe Light and Alarm Horn, NEMA-4X Rated Components
400207	AP275-705CID2	Strobe Light and Alarm Horn, CID2 Rated Components

Guardian Thermostatic Mixing Valves



The Guardian thermostatic mixing valves blend hot and cold water to deliver tepid water helping keep your team safe and your emergency shower and eyewash stations ANSI Z358.1-2014 compliant. Valves are engineered specifically for the critical demands of supplying your emergency shower or combination safety station. Depending on water supply size and pressure, valve may be able to supply multiple units.

FEATURES & BENEFITS

- Precision control thermal actuator senses incoming water temperature and automatically blends water to preset temperature
- If hot water supply is restricted or interrupted, internal bypass allows the valve to deliver cold water only
- If cold water supply is restricted or interrupted, the valve will close completely and not deliver any water at all, eliminating risk of scalding
- Valve is fully assembled and factory tested prior to shipment
- Valve meets the requirements of the US Safe Drinking Water Act as lead-free

CERTIFICATIONS

- ANSI/ASSE 1071

C&M PART #	MFG PART #	FLOW CAPACITY (GPM) PER 30 PSI PRESSURE DROP	INLET / OUTLET
400197	G6020	13	1/2" NPT(F)
400198	G6040	50	1 / 1-1/4" NPT(F)

Guardian Strobe Light & Alarm Horn Combination Units

The Guardian strobe light and alarm horn combination units help bring attention to emergency situations by alerting people in an area that an emergency safety station has been activated. Ideal for use in high traffic industrial applications, large spaces, areas with high ambient light and areas with high noise levels. Combination unit comes standard with additional contacts for connection to a remote monitoring system.



Use NEMA-4X unit (400206) in areas where corrosive materials and caustic cleaners such as disinfectants are used. Class I, Division 2 unit (400207) is ideal for use in C1D2 hazardous environments where flammable liquids or gases are not present during normal operating conditions. All units require 120 VAC, 0.3 amp electrical supply.

FEATURES & BENEFITS

- Weatherproof amber strobe light with shatter-resistant lens
- Weatherproof horn delivers distinctive, urgent signal
- NEMA-4X unit (400206) for use in areas where corrosive materials and caustic cleaners are used
- Class I, Division 2 unit (400207) for C1D2 settings where flammable liquids or gasses are not present during normal operating conditions
- Units are fully assembled, wired and factory tested prior to shipment

INCLUDES

Mounting bracket

C&M PART #	MFG PART #	COMPONENT PROTECTION	VISUAL CANDLE POWER	VISUAL FLASH RATE (FPM)	AUDIBLE SIGNAL*
400205	AP275-705	None	1,400,000	65	100 db at 10 ft
400206	AP275-705N4X	NEMA-4X	2,000,000	60	100 db at 10 ft
400207	AP275-705C1D2	Class I, Division 2	2,000,000	60	100 db at 10 ft

*Factory set



Helpful Tip: Emergency Equipment Water Temperature

The ANSI Z358.1-2014 "Emergency Eyewash and Shower Equipment" standard states that emergency equipment should deliver 'tepid' water in the event of an emergency. Tepid can be defined as 60°F and 100°F. In work environments where a chemical reaction is accelerated by flushing fluid temperature you should consult with a safety/health advisor. The delivery of tepid water

to emergency equipment may raise complicated engineering issues. Generally, the process involves providing the emergency equipment with both hot and cold water and then installing a thermostatic mixing valve.

It is important that you ensure your work environment complies with all applicable standards, regulations and laws.

24" Wide Push Brooms



Keep your work area clean with these 24" Wide Push Brooms. They feature an innovative and heavy-duty steel brace that is reinforced through a dual rivet connection to the handle and screwed onto the broom head for additional reinforcement. The handle is 1-1/8" in diameter, 60" long and features an end grip for added comfort while sweeping.

Use the **smooth surface** push broom to sweep fine dirt and debris while being gentle on surfaces like smooth concrete and polished wood floors. The **rough surface** push broom features coarse bristles for sweeping debris on surfaces like asphalt and sidewalks. The **multi-surface** push broom features soft flagged-tip border bristles and coarse center bristles for sweeping both fine dirt and rough debris.

C&M PART #	MFG PART #	DESCRIPTION
105223	BR24MU16	Multi-Surface with Wood Handle, 24" Wide
105224	BR24RG17	Rough Surface with Wood Handle, 24" Wide
105225	BR24SM15	Smooth Surface with Wood Handle, 24" Wide

Vestil™ Magnetic Push Sweeper

Magnetic Push Sweeper is ideal for cleaning up manufacturing facilities and construction sites. The sweeper with smooth rolling wheels collects both large and small materials. Ergonomically designed handle with an efficient handle-controlled release allows for comfortable upright position during use.



SPECIFICATIONS

CAPACITY (lbs)	30
HANDLE LENGTH EXTENDED	45-1/2"
HANDLE LENGTH LOWERED	31"
WHEEL WIDTH	1-1/2"
WHEEL DIAMETER	6-7/8"
REMOVAL PROCESS	Handle Release Lever
SWEEP WIDTH	24"
MATERIAL	Aluminum

C&M PART #	MFG PART #	DESCRIPTION
110955	MFSR-24	Magnetic Push Sweeper, Silver

Vestil™ Truck Stop



The Truck Stop protects people and property from drivers in dangerous areas. Constructed of lightweight, recycled plastic, it can be moved for seal coating, snow removal or change of location. No costly painting or maintenance. Requires only one person for installation. Hardware kits sold separately.

FEATURES & BENEFITS

- 100% recycled plastic offers long lasting rugged use
- Resists marring by oil, road salt, sunlight and chemicals
- Resists rotting, termite damage and corrosion
- High-visibility color draws drivers' attention
- Pre-drilled mounting holes make installation quick and easy

C&M PART #	MFG PART #	COLOR	WEIGHT (lbs)	MOUNTING HOLES	DIMENSIONS (L x W x H)
110720	CS-TB96-Y	Yellow	134	4	96" x 10" x 7"

Vestil™ Smoking Shelter/Bus Stop



Enjoy waiting or taking breaks out of the elements under the Smoking Shelter/Bus Stop. Rugged welded-steel frame provides excellent durability. Semi-clear polycarbonate side panels lets you easily view your surroundings. Corrugated polycarbonate sheet top with silver baked-in powder-coated finish offer toughness that can withstand the elements. Unit ships knocked down, but mounting plates include concrete lags for quick installation.

C&M PART #	MFG PART #	CAPACITY (Persons)	USABLE DIMENSIONS (W x H x D)
111050	SSH-7939-80	3 to 4	69-3/4" x 77-9/16" x 37-1/2"

Vestil™ Floor Tape Applicators



The Floor Tape Applicators are designed to apply tape as you walk. Solid steel construction, comfortable hand grips and durable rubber wheels allow for easy operation and maintenance. Both models feature a soft rubber applicator head.

C&M PART #	MFG PART #	COLOR	APPLICATION PATH	MAX ROLL DIAMETER	TAPE WIDTH MAXIMUM	TAPE WIDTH MINIMUM	WEIGHT (lbs)
111096	TPA-10	Black	Straight Line	6-1/2"	4"	1"	15
111097	TPA-20	Red	Circular or Straight Line	7"	4-1/2"	1"	21

Vestil™ Trash Cans



Keep your waste out of eyesight in heavy-duty and easy to move refuse containers. These durable high-density polyethylene Trash Cans withstand subzero cold temperatures as well as extreme summer heat. Each container includes two wheels for easy portability and hinged lips to keep the rain out.

C&M PART #	MFG PART #	DESCRIPTION
111091	TH-32-BLU	32 Gallon, Blue
111092	TH-32-GRN	32 Gallon, Green
111093	TH-32-GY	32 Gallon, Gray

Vestil™ Indoor Industrial Convex Mirrors

Enhance indoor workspace safety by optimizing traffic awareness, especially around corners where there is limited to no visibility, with Indoor Convex Mirrors. They are also useful security devices to help give a good overview of areas and removes blind spots.



FEATURES & BENEFITS

- 20% brighter than glass
- Made with grade A shatter-resistant acrylic
- 1" of diameter equals 1 foot of viewing distance

INCLUDES

Z bracket mounting hardware

SPECIFICATIONS

LENS MATERIAL	Acrylic
BACKING MATERIAL	Hardboard
TYPE	Convex
ENVIRONMENT	Indoor
SHAPE	Round

C&M PART #	MFG PART #	WIDTH	VIEWING DISTANCE COVERED (FT)
110715	CNVX-18	18"	20
110716	CNVX-30	30"	30

Vestil™ Steel Picnic Tables



Built to last and highly attractive, these commercial grade Steel Picnic Tables are constructed of expanded metal that features a diamond pattern. Tops and seats are coated with a rugged thermoplastic layer that's attractive and durable to endure the elements with virtually no maintenance. Galvanized tubular steel legs and supports are protected with a black powder-coat finish designed for strength and stability.

FEATURES & BENEFITS

- Expanded metal construction with a diamond pattern
- Finished to endure the elements for no maintenance
- Coated with a rugged thermoplastic layer
- Tubular steel legs and supports are powder coat black

C&M PART #	MFG PART #	DESCRIPTION
111010	PT-MX-3096-GN	Rectangular Top, 30" x 96", Green
111011	PT-MX-RT-46-BK	Round Top, 46" Diameter, Black

Vestil™ Speed Bumps



Protect your property and your employees with by installing a Speed Bump. The highly visible yellow draws the attention of the driver to slow down traffic. Strong recycled plastic construction withstands sunlight and is perfect for high traffic areas. Can be removed for seal coating, snow removal or to change locations.

FEATURES & BENEFITS

- 100% recycled plastic offers long lasting, rugged use
- Resists marring by oil, road salt, sunlight and chemicals
- Pre-drilled mounting holes make installation quick and easy
- Dual cable channel

INCLUDES

Installation hardware kit (concrete model comes with bolts, anchors and washers; asphalt model comes with spikes and butyl tape)

SPECIFICATIONS

COLOR	Yellow
COMPRESSION STRENGTH (lb/in ²)	3200
NUMBER OF MOUNTING HOLES	5
DUAL CHANNEL DIMENSIONS (H x W)	3/4" x 1"
MATERIAL	Recycled Plastic

C&M PART #	MFG PART #	INSTALLATION TYPE	WEIGHT (LB)
111028	SB-108	Concrete	58
111029	SBA-108	Asphalt	54

Vestil™ Speed Humps



Install Speed Humps to control traffic and reduce vehicle speeds in neighborhoods, construction areas, hospitals, post offices and airports. Speed humps are constructed of black recycled and virgin rubber with yellow embedded highway tape to ensure high visibility. Full hump units include five center and two end modules. Can be removed for seal coating, snow removal or change of location.

FEATURES & BENEFITS

- Durable design and construction for added strength and long life
- Easy tongue and groove installation
- Use in commercial or industrial applications for optimal results

INCLUDES

Installation hardware kits

Vestil™ Heavy-Duty Speed Bumps

These Heavy-Duty Speed Bump is ideal for warning and slowing down drivers in parking areas and warehouses. Constructed of heavy-duty molded rubber, the speed bump end caps are designed to secure the ends of speed bumps—order separately.

FEATURES & BENEFITS

- UV stabilizer for longer life
- Five reflective yellow diagonal stripes and “cats eyes” per side for even better visibility
- Pre-drilled mounting holes make installation quick and easy



INCLUDES

Installation hardware kits

SPECIFICATIONS

COLOR	Black
UNIFORM CAPACITY (LB)	40,000
NUMBER OF MOUNTING HOLES	4
MATERIAL	Molded Plastic

C&M PART #	MFG PART #	INSTALLATION TYPE	WEIGHT (LB)
111033	SBRY-72-C	Concrete	55
111032	SBRY-72-A	Asphalt	53

REPLACEMENT PARTS & ACCESSORIES

C&M PART #	MFG PART #	DESCRIPTION	INSTALLATION TYPE
111035	SBRY-CAP-C	Heavy-Duty Speed Bump End Caps, 2/Pack	Concrete
111034	SBRY-CAP-A	Heavy-Duty Speed Bump End Caps, 2/Pack	Asphalt

SPECIFICATIONS

REDUCE SPEED (MPH)	5 to 10
MATERIAL	Rubber
COLOR	Black/Yellow

C&M PART #	MFG PART #	INSTALLATION TYPE	UNIFORM CAPACITY (lbs)	DIMENSIONS (L x W x H)
111023	RSH-108-24-C	Concrete	40,000	110-3/4" x 23-1/2" x 1-5/8"
111022	RSH-108-24-A	Asphalt	40,000	110-3/4" x 23-1/2" x 1-5/8"
111026	RSH-120-36-C	Concrete	60,000	118-11/16" x 35-1/4" x 1-7/8"
111025	RSH-120-36-A	Asphalt	60,000	118-11/16" x 35-1/4" x 1-7/8"

REPLACEMENT PARTS & ACCESSORIES

C&M PART #	MFG PART #	DESCRIPTION	UNIFORM CAPACITY (lbs)	DIMENSIONS (L x W x H)
401702	RSH-108-M-C	Speed Hump Middle Section, Concrete	40,000	19-3/16" x 23-1/2" x 1-5/8"
111024	RSH-108-M-A	Speed Hump Middle Section, Asphalt	40,000	19-3/16" x 23-1/2" x 1-5/8"
401703	RSH-120-M-C	Speed Hump Middle Section, Concrete	60,000	20-5/16" x 35-1/4" x 2-7/16"
111027	RSH-120-M-A	Speed Hump Middle Section, Asphalt	60,000	20-5/16" x 35-1/4" x 2-7/16"

UltraTech Ultra-Sidewinder® Cable Protection System

The Ultra-Sidewinder Cable Protection System is an innovative new solution for protecting cables run across a floor. The new design articulates left and right—allowing the system to turn corners and adapt to the layout of the room while maintaining full protection for the cables and trip protection for pedestrians. Cables can be left in the system for ultimate portability or left in place indefinitely. There is no longer a compromise between safety and flexibility.



FEATURES & BENEFITS

- Modular design makes it easy to reconfigure, repair and replace targeted segments, even while cable remains connected
- Simple “snap in” assembly—no tools or cutting required
- UV resistant—can be used indoors or outdoors

INCLUDES

Endcaps

C&M PART #	MFG PART #	COLOR	DIMENSIONS (L x W x H)	OPEN CHANNEL SIZE (W x H)	WEIGHT (lbs)	WEIGHT CAPACITY UDL (lb/in ²)
109334F84Q	1800	Black/ Yellow	39-1/2" x 3" x 3/4"	3/4" x 3/8"	1.5	2000
109334174Q	1802	Black	39-1/2" x 3" x 3/4"	3/4" x 3/8"	1.5	2000
109334F8MD	1830	Black/ Yellow	33" x 9-3/4" x 1-3/8"	3" x 3/4"	6	260
109334F8SR	1840	Black/ Yellow	34" x 13-5/8" x 2-1/8"	3" x 1-1/2"	13.5	260

UltraTech Ultra-Drip Diverter® Pipe Drip Diverter



Leaking pipes can be annoying, frustrating and potentially dangerous. The Ultra-Drip Diverter captures leaks from pipes and routes them away from personnel and machinery using a standard hose (not included) to a drain, sink or container. Coated vinyl diverter features heavy-duty grommets for easy installation.

FEATURES & BENEFITS

- Keep fluid leaks off the floor to eliminate slip hazards and chemical exposure
- Large 18" diameter opening captures overhead leaks, big and small
- Connects to a standard garden hose for easy collection
- Rugged, coated vinyl construction—ships complete with bungee cords and hooks for quick installation

C&M PART #	MFG PART #	DIAMETER	CONTAINMENT CAPACITY (GAL)	WEIGHT (lbs)
109327	1780	18"	7	2

UltraTech Ultra-Drip Diverter® Roof Drip Diverters



Use these Roof Drip Diverters to catch roof leaks and divert them to the proper drainage point with a hose. The large, lightweight vinyl-coated fabric is easy to set up so you can protect expensive assets such as office equipment, machinery or stored inventory from water damage. They feature heavy-duty grommets in each corner for quick installation and folds up nice and small for easy storage.

FEATURES & BENEFITS

- Standard hose hook-up
- 10 oz. material
- Heavy-duty grommets in each corner

C&M PART #	MFG PART #	DIMENSIONS (L x W)	WEIGHT (lbs)
10932843	1785	5 ft x 5 ft	2
10932844	1786	7 ft x 7 ft	4
10932845	1787	10 ft x 10 ft	8
10932846	1788	12 ft x 12 ft	15
10932847	1789	15 ft x 15 ft	22
10932848	1790	20 ft x 20 ft	36

Versa-Kool Mobile Spot Cooler Fans with OSHA Guards



High-quality industrial Versa-Kool Drum Fans are designed to provide powerful and efficient cooling in various commercial and industrial settings. Also known as Horizontal Air Flow (HAF) fans, they move air in a horizontal pattern to create a gentle ceiling to floor circulating flow. Known for their durability, reliability and performance, these fans are typically used in warehouses, factories, workshops, garages, and other large spaces where air circulation and cooling are required.

Drum fans are equipped with a heavy-duty motor and a durable polyethylene drum housing that ensures long-lasting performance. They are designed with safety in mind, with features such as OSHA-compliant guards and sturdy construction.

C&M PART #	MFG PART #	DESCRIPTION
107956X130	VKM24-O	Single-Speed, 24" Diameter, White Guard/Metallic Blades
107956AE30	VKM36-O	Single-Speed, 36" Diameter, White Guard/Gray Blades
107959AE50	VKM36-2-B-O	Two-Speed, 36" Diameter, Black Guard/Gray Blades
107956AP50	VKM42-2-O	Two-Speed, 42" Diameter, White Guard/Gray Blades

MASTER High-Velocity Tiltable Direct-Drive Floor Fans



The High-Velocity Tiltable Floor Fans move a large volume of air quickly and efficiently to help cool down quickly. Fans feature a powerful motor and fan blades that are designed to move air at a high velocity, providing effective cooling and air circulation in large spaces. These fans are commonly used in industrial, commercial and even residential settings where strong airflow and cooling are required.

Easily tilt the fan head to direct the airflow in a specific direction. Large wheels make it easy to transport and place it exactly where you need it.

C&M PART #	MFG PART #	DESCRIPTION
10795201X1	24DCT	Two-Speed, High-Velocity Tiltable Barrel Fan, 24" Diameter
10795201Z1	30BCT	Three-Speed, High Velocity Tiltable Basket Fan, 30" Diameter

Dri-Eaz Axial Fans



Use the Vortex to drive air through 125 feet or more of ducting to ventilate areas during remodels, new construction, manufacturing or flood restoration. Featuring 12" duct rings on both sides, the fans can be used to pull musty, stale air out or draw fresh air in. Use it to dry large areas like gyms, crawlspaces, storage facilities and more.

FEATURES & BENEFITS

- Powerful 1.0 HP motor
- Built-in handle for easy portability
- Stackable for storage saves space
- Operate standalone or with Sto & Go ducting

SPECIFICATIONS

DIMENSIONS (W x H x D)	18.7" x 19.2" x 15.7"
CONTROLS	On/Off Switch
CORD LENGTH (ft)	20
MAX CFM (CUBIC FEET PER MINUTE)	2041
POWER	115 VAC, 7.4 A

CERTIFICATIONS

- Listed to UL/cUL standards

C&M PART #	MFG PART #	COLOR
401221	116594	Blue
401222	115088	Yellow

REPLACEMENT PARTS & ACCESSORIES

C&M PART #	MFG PART #	DESCRIPTION
401257	113260	Sto & Go Vortex Ducting, 25 ft L

TALK TO AN EXPERT TODAY!

Need application advice or help to locate a part? Contact our technical specialists, they are here to help!

1-888-885-2673

Dri-Eaz Airmovers



These Airmovers provide superior air circulation and drying efficiency with durable construction. Low noise pollution and decreased operating costs due to energy efficiency make these perfect for any job. Combining airmovers with a dehumidifier to expedite the drying process; the airmover promotes evaporation and the dehumidifier draws the moisture out of the air.

The **Stealth AV3000 Airmover** (401223) is a high-velocity fan ideal for ventilating smoke, dust and fumes. Producing up to 2600 CFM of air flow, it easily dries large spaces fast. Use the variable-speed control to customize airflow and noise levels. The advanced blade design delivers quiet operation and high intensity airflow. Integrated stand makes it easy to direct air where you need it.

The **Sahara Pro X4 TurboDryer** (401226) is a high-velocity, low-amp airmover with remarkable drying power. Use its focused, high-powered airflow to quick-dry floors, walls, ceilings and more after cleaning, leaks and/or floods. TurboDryer offers versatile, 3-speed, 3-position operation, GFCI outlets to connect up to 6 units, and built-in clamp for under carpet drying. Lightweight, easy-to-carry design stacks vertically for easy storage.

The **Velo Pro Low-Profile Airmover** (401224) offers unbeatable versatility and portability. Daisy-chain up to 10 units on a single 15-amp circuit. With variable-speed control and patented low-profile outlet design, the airmover ensures an even, broad path airflow for fast, consistent drying across all surfaces. A convenient kick stand provides a total of five operating positions. Easily carry two units at once or stack up to six to transport.

The **Velo Low-Profile Airmover** (401225) offers portability, ruggedness and professional performance at a great value. Daisy-chain up to six units on a single 15-amp circuit; up to 10 units on the low setting. With dual-speed control and patented low-profile outlet design, the airmover ensures an even, broad path airflow for fast, consistent drying across all surfaces. Select from four operating positions for drying floors, ceilings, walls and stairways quickly and efficiently. Easily carry two units at once or stack up to five to transport.

The **Velo HEPA Kit** (401264) converts the Velo and Velo Pro airmovers into air scrubbers. Installation is simple, taking a minute or less and requires no tools. Ideal for general in-room air scrubbing to remove particulates and improve air quality while drying. The prefilter cover extends the life of your HEPA filter.

CERTIFICATIONS

- ETL listed to UL/cUL and CSA Standards

C&M PART #	MFG PART #	AIR MOVEMENT (CFM)	DIMENSIONS (W x H x D)	POWER	POWER CORD LENGTH (ft)	SPEEDS	SOUND LEVEL (dB)	WEIGHT (lb)
A STEALTH AV3000 AIRMOVER								
401223	113164	2600	24" x 10.8" x 24.3"	115 VAC, 2.7 A	15	Variable	58 to 72	27.5
B SAHARA PRO X4 TURBODRYER								
401226	124315	867	17.3" x 17.4" x 15"	115 VAC, 1.9 to 2.5 A	16	3	-	21.7
C VELO PRO LOW-PROFILE AIRMOVER								
401224	114969	500 to 885	8.8" x 23.6" x 18"	115 VAC, 1.2 to 1.9 A	18	Variable	69	18.6
D VELO LOW-PROFILE AIRMOVER								
401225	125470	885	8.8" x 23.6" x 18"	115 VAC, 1.65 to 2.1 A	15	2	69	18.6

REPLACEMENT PARTS & ACCESSORIES FOR VELO AND VELO PRO AIRMOVERS

C&M PART #	MFG PART #	DESCRIPTION
401264	105627	HEPA Airmover to Air Scrubber Filter Conversion Kit
401228	111333	HEPA Airmover to Air Scrubber Conversion Replacement Filter
401229	111327	HEPA Airmover to Air Scrubber Conversion Replacement Prefilters, Pack of 20
401267	117718	Stacking Clips Kit, 5 Sets



Dri-Eaz DriForce® Airmovers & Air Dryers



Use the DriForce Airmovers and Dryers to quickly dry hard-to-reach areas and complex assemblies. The Air Drying System comes complete with the airmover base unit to direct high-pressure air into wall cavities, cabinetry and other dense construction assemblies for fast, effective drying.

The Airmover Base Unit is a high-pressure specialty blower that delivers up to 38" of static pressure for fast drying in complex construction and dense materials. Use with the air drying system accessory kit (401252) or the Rescue Mat® panel kit (401256) to draw moist air out of wall cavities, hardwood floors and other cavities. For larger jobs consider upgrading to the XL Air Drying Base Unit (401247).

C&M PART #	MFG PART #	DESCRIPTION	WORKING STATIC PRESSURE	DIMENSIONS (W x H x D)	POWER	WEIGHT (lbs)
401248	115991	Air Drying System (with Airmover Base Unit)	38"	12" x 14" x 14"	115 VAC, 4.8 A	97
401249	104670	Airmover Base Unit	38"	12" x 14" x 14"	115 VAC, 4.8 A	14.5
401247	124159	XL Air Drying Base Unit	88"	27" x 19" x 21"	115 VAC, 12 A	87

REPLACEMENT PARTS & ACCESSORIES

C&M PART #	MFG PART #	DESCRIPTION
401252	103794	Air Drying System Accessory Kit
401256	119217	Rescue Mat Panel Kit



Helpful Tip: Prevent & Stop Rust

Cold water running through treatment plant pipes can lead to condensation, and ultimately rust. Proper preventative maintenance can keep rust in check, including using paint and dehumidifiers. Paint acts as a physical barrier that shields the metal from direct exposure to air and moisture. This protective layer inhibits the oxidation process, preventing the formation of rust. Dehumidifiers remove excess moisture from the air, creating an environment less conducive to the corrosion, and rust forming, process. If you notice rust has begun forming, you can use a rust converter which is a chemical solution that reacts with the rust, turning it into a different compound, slowing further corrosion.

Check out Rust-Oleum®'s V7400 Rust Preventative Coating and Core & Main's Rust Converter on page 162.

Quest 70 Dehumidifier



The economical and high performing Quest 70 Dehumidifier has one of the widest temperature and relative humidity operating ranges. Its compact size allows for easy mobility and overhead or ground placement with a small footprint to fit your space. Dehumidifier comes equipped with a MERV 13 media filter for superior filtration of harmful contaminants in the air such as dust, pollen and mold as well as bacteria and some viruses. In the event of a power outage, unit automatically defaults to prior settings. Meets California Title 24 requirements for both ducted (whole-home) and nonducted (portable) installations.

FEATURES & BENEFITS

- No installation required
- Low amp draw—frees up electricity for other equipment
- Onboard dehumidistat with a low voltage terminal block

INCLUDES

Drain hose and filter; 5-year warranty

SPECIFICATIONS

WATER REMOVAL AHAM (pts/day at 80°F/60%RH)	70
EFFICIENCY (pints/kWh at 80°F/60%RH)	5
WATER REMOVAL (pts/day at 75°F/50%RH)	43
EFFICIENCY (pints/kWh at 75°F/50%RH)	3.3
AIR MOVEMENT (CFM)	150
DIMENSIONS (W x H x D)	12" x 12" x 21.5"
WEIGHT (lbs)	55
AMPS (at 80°F/60%RH)	5.1
POWER (Watts)	580
SUPPLY VOLTAGE	110 to 120 VAC, 1 Ph, 60 Hz
OPERATING RANGE (°F)	33 to 100
REFRIGERATION CHARGE (R410A)	15 OZ

CERTIFICATIONS

- UL Rated and ETL Listed

C&M PART #	MFG PART #	DESCRIPTION
401632	4033750	70 Dehumidifier

Quest 100 Dehumidifier



The Quest 100 dehumidifier boasts Quest's unique M-CoRR technology. This patented multi-coil design improves efficiency, meaning savings on energy use and cost. The 100 dehumidifier has premium MERV-13 filtration, without compromising capacity or efficiency. This superior filtration helps prevent the start or spread of bacteria, mold or other contaminants around your facility with 65% more effectiveness than MERV-8 and 20% more effectiveness than MERV-11. MERV-13 filtration means healthier air and more control over your environment. The corrosion resistant base and small footprint means the Quest 100 has flexible placement options, overhead or on the ground, without the worry of rust. Meets California Title 24 requirements for both ducted (whole-home) and non-ducted (portable) installations.

FEATURES & BENEFITS

- No installation required
- Onboard digital control with low voltage terminal block for optional external control
- Removable access panel for easy, in-place maintenance and serviceability

INCLUDES

Drain hose and filter; 5-year warranty

SPECIFICATIONS

WATER REMOVAL AHAM (pts/day at 80°F/60%RH)	100
EFFICIENCY (pints/kWh at 80°F/60%RH)	7.5
WATER REMOVAL (pts/day at 75°F/50%RH)	67
EFFICIENCY (pints/kWh at 75°F/50%RH)	5.4
AIR MOVEMENT (CFM)	280
DIMENSIONS (L x W x H)	24" x 16" x 14.5"
WEIGHT (lbs)	60
AMPS (at 80°F/60%RH)	5
POWER (Watts)	540
SUPPLY VOLTAGE	120 VAC, 1 Ph, 60 Hz
OPERATING RANGE (°F)	56 - 95
REFRIGERATION CHARGE (R410A)	1 LB 7 OZ

CERTIFICATIONS

- UL Rated and ETL Listed

C&M PART #	MFG PART #	DESCRIPTION
401999	4041870	100 Dehumidifier

Quest Hi-E Dry 195 Dehumidifier

The Hi-E Dry 195 Portable Dehumidifier is designed and built with an emphasis on efficiency and durability. The high-efficiency design offers high-capacity water removal at dramatically reduced utility costs. It features a smaller, more efficient refrigeration system that eliminates the need for 220-volt circuits in many applications.



Use the onboard dehumidistat controller to set relative humidity (RH) levels from 20 to 80%. Digital display makes it easy to view current RH, RH setpoint, and current temperature as well change settings. Dehumidifier comes equipped with a MERV 11 air filter which can remove harmful contaminants from the air such as dust, pollen and mold.

FEATURES & BENEFITS

- No installation required
- Internal condensate pump capable of lifting condensate up to 17 feet
- Automatically defaults to prior settings in the event of power outage
- Integrated handles and casters for mobility

INCLUDES

30-foot drain hose and filter. 5-year warranty

SPECIFICATIONS

WATER REMOVAL AHAM (pts/day at 80°F/60%RH)	195
EFFICIENCY (pints/kWh at 80°F/60%RH)	5.4
WATER REMOVAL (pts/day at 75°F/50%RH)	138
EFFICIENCY (pints/kWh at 75°F/50%RH)	4.1
AIR MOVEMENT (CFM)	610
DIMENSIONS (W x H x D)	20" x 42" x 19"
WEIGHT (lbs)	130
AMPS (at 80°F/60%RH)	13
POWER (Watts)	1500
SUPPLY VOLTAGE	110 to 120 VAC, 1 Ph, 60 Hz
OPERATING RANGE (°F)	56 to 110
REFRIGERATION CHARGE (R410A)	2 LB

CERTIFICATIONS

- UL Rated and ETL Listed

C&M PART #	MFG PART #	DESCRIPTION
401631	4036710	Hi-E Dry 195 Dehumidifier



Quest 335 Dehumidifiers

Use the high-efficiency 335 Dehumidifiers for effectively removing humidity from high moisture work environments. These units feature patented M-CoRR (Multi-Coil Refrigeration) system that recycles excess heat to provide high efficiencies, while reducing heat (BTUs) output into your space. The M-CoRR technology offers operational cost savings through efficient energy consumption as well as reduced air conditioning usage.

In addition to the industry leading MERV-13 filtration, the 335 dehumidifiers feature a unique filter compensation technology. Filter compensation technology increases the fan speed as the filter becomes increasingly clogged with pollen, powdery mildew and dirt. This speed adjustment allows for the same amount of air to pass through the filter without reducing the cubic feet per minute (CFM). As a result, the unit is able to work consistently and constantly to optimize your work environment with maximum energy efficiency and consistency.

Select the 277 VAC unit for use in industrial facilities with 277 VAC outlets. The higher voltage unit uses less amperage, freeing up electricity for other equipment. Both units meet California Title 24 requirements for both ducted (whole-home) and nonducted (portable) installations.

FEATURES & BENEFITS

- No installation required
- Automatically defaults to prior settings in the event of power outage
- Integrated hang points and handles allow for easy movement and flexible installation
- Digital onboard control with optional external control
- Easy access removable panel for easier in-place maintenance and service

INCLUDES

Drain hose and filter; 5-year warranty



SPECIFICATIONS

MODEL	208/230V	277V
WATER REMOVAL AHAM (pts/day at 80°F/60%RH)	350	350
EFFICIENCY (pints/kWh at 80°F/60%RH)	9.3	8.5
WATER REMOVAL (pts/day at 75°F/50%RH)	233	230
EFFICIENCY (pints/kWh at 75°F/50%RH)	6.7	6.2
AIR MOVEMENT (CFM)	900	900
DIMENSIONS (W x H x D)	32.9" x 23.7" x 24.6"	32.9" x 23.7" x 24.6"
WEIGHT (lbs)	215	215
AMPS (at 80°F/60%RH)	9 at 208 VAC, 7.5 at 230 VAC	6.8
POWER (Watts)	1565	1789
OPERATING RANGE (°F)	56 to 95	56 to 95
REFRIGERATION CHARGE (R410A)	4 LB 12 OZ	4 LB 12 OZ

CERTIFICATIONS

- UL Rated and ETL Listed

C&M PART #	MFG PART #	SUPPLY VOLTAGE
401633	4042500	208/230 VAC
401634	4042600	277 VAC

CHECK US OUT ONLINE



Visit supply.coreandmain.com for your water & wastewater maintenance, repair, and operations needs.

Quest 506 Dehumidifiers

This powerful and efficient 506 Dehumidifier can pull up to 500 pints of water from the air every 24 hours—perfect for large commercial and industrial work environments. These units feature patented M-CoRR (Multi-Coil Refrigeration) system that recycles excess heat to provide high efficiencies, while reducing heat (BTUs) output into your space. The M-CoRR technology offers operational cost savings through efficient energy consumption as well as reduced air conditioning usage.



Dehumidifiers come equipped with a MERV 13 media filter for superior filtration of harmful contaminants from the air such as dust, pollen and mold as well as bacteria and some viruses. Both the 230V and 277V units have a low amp draw, freeing up electricity for other equipment. Install the 277V unit without the additional installation buck-boost transformers and the associated cost of wiring. Both units require external control (not included). Both models meet California Title 24 requirements for both ducted (whole-home) and nonducted (portable) installations.

FEATURES & BENEFITS

- No installation required
- Automatically resets to previous settings in the event of power outage
- Integrated hang points and handles allow for easy movement and flexible installation

INCLUDES

Filter; 5-year warranty

SPECIFICATIONS

MODEL	230V	277V
WATER REMOVAL AHAM (pts/day at 80°F/60%RH)	506	506
EFFICIENCY (pints/kWh at 80°F/60%RH)	8.1	8.1
WATER REMOVAL (pts/day at 75°F/50%RH)	349	349
EFFICIENCY (pints/kWh at 75°F/50%RH)	6.2	6.2
AIR MOVEMENT (CFM)	1500	1350 at 0.0" WG
DIMENSIONS (W x H x D)	28.9" x 34.1" x 44.8"	30.1" x 33.8" x 44.8"
WEIGHT (lbs)	280	280
AMPS (at 80°F/60%RH)	11	10
POWER (Watts)	2700	2700
OPERATING RANGE (°F)	56 to 95	56 to 95
REFRIGERATION CHARGE (R410A)	4 LB 8 OZ	4 LB 8 OZ

CERTIFICATIONS

- UL Rated and ETL Listed

C&M PART #	MFG PART #	SUPPLY VOLTAGE
401635	4036600	220-240 VAC
401636	4036610	277 VAC

Dri-Eaz PHD 200 Dehumidifier



The compact, versatile PHD 200 dehumidifier is ideal for temporary use in moisture-prone areas that need ongoing humidity control. Install in basements, crawlspaces or equipment rooms. The command hub feature allows Bluetooth and wi-fi connectivity for controlling the dehumidifier and viewing jobsite conditions remotely using the Command Center Pro App and Dashboard, available in the Apple Store and Google Play Store.

View the real-time temperature, relative humidity, grain depression and drying progress trends on the command hub touchscreen. Humidistat keeps moisture under control, set for 40% to 90% RH (relative humidity) in 5% increments.

FEATURES & BENEFITS

- Fast and convenient access to humidistat, job hours, maintenance reminders and more
- Display in three languages
- Automatic pumpout allows continuous operation, pumps out up to 3 feet above unit
- Auto-restart after outage when power is restored

SPECIFICATIONS

WATER REMOVAL AHAM (pts/day at 80°F/60%RH)	74
WATER REMOVAL (pts/day at 90°F/90%RH)	120
AIR MOVEMENT (CFM)	180
DIMENSIONS (W x H x D)	12.5" x 17.6" x 21.5"
HOUSING	Rotomolded polyethylene
WEIGHT (lbs)	65
AMPS (at 80°F/60%RH)	6.2
POWER	115 VAC, 60 Hz
SOUND LEVEL (dB)	55
OPERATING RANGE (°F)	45 to 100

CERTIFICATIONS

- ETL listed to CSA standards

C&M PART #	MFG PART #	DESCRIPTION
401269	103806	PHD 200 Dehumidifier

REPLACEMENT PARTS & ACCESSORIES

C&M PART #	MFG PART #	DESCRIPTION
401270	116689	Replacement Filters, Pack of 3
401266	106996	Dehumidifier Duct Attachment Kit
401271	106773	Hanging Kit
401259	124402-1	Replacement Command Hub

Dri-Eaz DrizAir® 1200 Dehumidifier



The compact and portable 1200 Dehumidifier removes moisture from everyday spills and reduces humidity in basements, facilities or on construction sites. Use the dehumidifier to remove up to 18 gallons of water per day. Semi-pneumatic wheels and sturdy handle make it easy to transport. Multilingual electronic touchpad controls offer easy operation. Rugged rotomolded housing is stackable up to two high for storage.

FEATURES & BENEFITS

- Removes up to 18 gallons a day
- Hot-gas bypass for fast defrost
- Built-in duct attachment ring
- Automatic restart when power is restored after outage
- 6-year warranty on compressor and coils

SPECIFICATIONS

WATER REMOVAL AHAM (pts/day at 80°F/60%RH)	64
WATER REMOVAL MAX (pts/day at saturation)	145
AIR MOVEMENT (CFM)	250
DIMENSIONS (W x H x D)	20" x 32" x 19.5"
HOUSING	Rotomolded polyethylene
WEIGHT (lbs)	80
AMPS (at 80°F/60%RH)	5.3
POWER	115 VAC, 60 Hz
CORD LENGTH (ft)	25
OPERATING RANGE (°F)	33 to 100

CERTIFICATIONS

- ETL listed to CSA 22.2 #92

C&M PART #	MFG PART #	DESCRIPTION
401236	104677	DrizAir 1200 Dehumidifier

REPLACEMENT PARTS & ACCESSORIES

C&M PART #	MFG PART #	DESCRIPTION
401240	100250	4-PRO Four Stage Replacement Air Filter, Pack of 24

Dri-Eaz Revolution LGR Dehumidifier



The Revolution LGR Dehumidifier is compact, stackable and easy to transport. Its space saving design and state of the art technology lets you bring the high-performance drying power to every task. Load two on a hand truck for easy transport. The command hub feature allows Bluetooth and wi-fi connectivity for controlling the dehumidifier and viewing jobsite conditions remotely using the Command Center Pro App and Dashboard, available in the Apple Store and Google Play Store.

View the real-time temperature, relative humidity, grain depression and drying progress trends on the command hub touchscreen.

FEATURES & BENEFITS

- Delivers excellent dehumidifying power in a compact size
- Quick and easy access inside unit for cleaning
- 6-year warranty on compressor and coils

SPECIFICATIONS

WATER REMOVAL AHAM (pts/day at 80°F/60%RH)	80
WATER REMOVAL (pts/day at 90°F/90%RH)	144
AIR MOVEMENT (CFM)	121 to 180
DIMENSIONS (W x H x D)	12.5" x 17.6" x 21.5"
HOUSING	Rotomolded polyethylene
WEIGHT (LB)	63
AMPS (at 80°F/60%RH)	5.5
POWER	115 VAC, 60 Hz
SOUND LEVEL (dB)	61
OPERATING RANGE (°F)	33 to 100
REFRIGERANT	R32

CERTIFICATIONS

- ETL listed to CSA standards

C&M PART #	MFG PART #	DESCRIPTION
401235	111995	Revolution LGR Dehumidifier

REPLACEMENT PARTS & ACCESSORIES

C&M PART #	MFG PART #	DESCRIPTION
401242	102312	4-PRO Four-Stage Replacement Air Filter, Pack of 24
401266	106996	Dehumidifier Duct Attachment Kit
401271	106773	Hanging Kit
401259	124402-1	Replacement Command Hub

Dri-Eaz i-Series LGR Dehumidifiers



The i-Series Low Grain Refrigerant (LGR) Dehumidifiers are compact, powerful and easy to move. These dehumidifiers automatically adjust operation for maximum efficiency in low relative humidity (RH) or high temperature environments.

All models feature the command hub that allows Bluetooth and wi-fi connectivity for controlling the dehumidifier and viewing jobsite conditions remotely using the Command Center Pro App and Dashboard, available in the Apple Store and Google Play Store. View the real-time temperature, relative humidity, grain depression and drying progress trends on the command hub touchscreen.

The **LGR 2800i** removes up to 130 pints at a day while only drawing just 8 amps. Built-in thermohygrometer monitors and displays inlet and outlet conditions.

The **LGR 3500i** is capable of controlling humidity in spaces up to 17,000 cubic feet. The LGR 3500i takes industry-leading performance and puts it in a highly durable and portable package, making it easy to relocate and position out of operators' way.

The **LGR 6000i** is the quietest and best-performing i-Series dehumidifier. Perfectly sized for everyday jobs it removes more water than any other competitive units in its class. Displays grain depression, graphs drying progress and provides quick access to humidistat settings. Its Extreme Dewpoint Technology™ (EDT) delivers the fastest response to changing humidity conditions.

The **LGR 7000 XLi** delivers portable, high-performance water removal, even at low humidity levels. Reduce and control excess moisture fast with the patented Advanced Crossflow technology that optimizes the LGR 7000 dehumidifier moisture removal in virtually all conditions. The LGR 7000 XLi model features a sealed, large capacity pump basin large enough to contain water from an unintentional defrost after a power outage or other unexpected shutdown.

FEATURES & BENEFITS

- Fast and convenient access to humidistat, job hours, maintenance reminders and more
- Automatic high temperature mode no manual adjustments required
- Rotomolded housing resists dents and scratches and is easy to maintain
- Use all-in-one 4-PRO filter, electrostatic mesh filtration with antimicrobial treatment and odor-fighting carbon
- Automatic restart after power is restored following an outage
- 6-year warranty on compressor and coils

CERTIFICATIONS

- ETL listed to CSA 22.2 no. 92

C&M PART #	MFG PART #	DESCRIPTION	WATER REMOVAL AHAM (pts./day at 80°F/60%RH)	WATER REMOVAL (pts./day at 90°F/90%RH)	AIR MOVEMENT (CFM)	DIMENSIONS (W x H x D)	WEIGHT (lbs)	POWER	OPERATING RANGE (°F)
401232	110128	LGR 2800i	130	200	400	24" x 40.5" x 23"	156	120 VAC, 8.0 A	33 to 100
401231	110133	LGR 3500i	170	264	400	24" x 40.5" x 23"	158	120 VAC/10.8 A	33 to 100
401234	103614	LGR 6000Li	100	204	320	32.1" x 19.8" x 20"	103	120 VAC, 6.5 A	33 to 100
401233	108110	LGR 7000 XLi	130	235	280	20" x 33.5" x 20"	106	115 VAC, 8.8 A	33 to 100

REPLACEMENT PARTS & ACCESSORIES

C&M PART #	MFG PART #	DESCRIPTION	FOR USE WITH
401237	121708	4-PRO Four Stage Replacement Air Filter, Pack of 24	LGR 2800i and LGR 3500i
401238	100254	4-PRO Four Stage Replacement Air Filter, Pack of 24	LGR 6000Li
401240	100250	4-PRO Four Stage Replacement Air Filter, Pack of 24	LGR 7000 XLi
401260	124507	Replacement Command Hub	LGR 2800i and LGR 3500i
401259	124402-1	Replacement Command Hub	LGR 6000Li and LGR 7000 XLi



**Dri-Eaz DriTec® 4000i
Desiccant Dehumidifier**



The DriTec 4000i Desiccant Dehumidifier offers powerful, versatile desiccant dehumidification. Smart controls monitor the system performance and set minimum and maximum humidity levels to eliminate concerns about over-drying. Dehumidifier features Onboard min/max humidistat controls and pints-per-day display. Rugged vacuum-molded back protects the unit during loading, unloading and transport; unit works on its back in low clearance areas

The DriTec 4000i Reactivation Ducting Kit provides replacement ducting for 4000i dehumidifier. Proper ducting of reactivation air is required for desiccant use. This ducting offers rugged construction, durable heat-resistant materials and a long service life.

FEATURES & BENEFITS

- Positive Thermal Coefficient heaters provide better efficiency, safety and longer life
- Built-in compartment provides storage for power cords and ducting
- On unit guide for ducting setup

SPECIFICATIONS

WATER REMOVAL (pts/day at 80°F/60%RH)	118
PROCESS AIR (CFM)	395
REACTIVATION AIR (CFM)	65
DIMENSIONS (W x H x D)	21.14" x 33.13" x 20.25"
WEIGHT (lbs)	95
POWER (at 80°F/60%RH)	115 VAC; Circuit 1: 12 A Circuit 2: 12 A

CERTIFICATIONS

- ETL listed to CSA dehumidifier standards

C&M PART #	MFG PART #	DESCRIPTION
401230	114621	DriTec 4000i Desiccant Dehumidifier

REPLACEMENT PARTS & ACCESSORIES

C&M PART #	MFG PART #	DESCRIPTION
401265	108412	DriTec 4000i Desiccant Reactivation Ducting Kit
401241	100252	4-PRO Four-Stage Replacement Air Filter for DriTec 4000i, Pack of 24

NEED HELP FINDING AN ITEM?



Core & Main has access to thousands of products from hundreds of suppliers.

Check out our full assortment of products and suppliers online at supply.coreandmain.com or speak with one of our customer service representatives at **1-888-885-2673**.



SHOP CORE & MAIN SUPPLY

Dri-Eaz Protimeter Surveymaster

Use this Protimeter Surveymaster to search out and measure moisture. Meter uses two different methods to detect moisture; a set of penetrating pins and non-invasive radio frequencies. View readings on the LCD and LED color-coded scale. Meter is ergonomically designed for comfortable, one-handed operation. A patented new Reference mode lets you compare readings to a dry standard you set based on the situation.

FEATURES & BENEFITS

- Large, easy to read backlit display
- Rugged, restoration ready construction
- Instant readings in a wide range of building materials



INCLUDES

One 9V battery

SPECIFICATIONS

DIMENSIONS (W x H x D)	2.75" x 1.9" x 7.5"
MAXIMUM PIN PENETRATION	0.4"
PIN MOISTURE MEASUREMENT RANGE	8 to 99% Wood Moisture Equivalent (WME), Readings Over 30% Are Relative
PINLESS (NON-INVASIVE RF) MEASUREMENT RANGE	60 to 1000 (Relative), Measures 0.75" Deep
WEIGHT (oz)	8

C&M PART #	MFG PART #	DESCRIPTION
401253	115672	Protimeter Surveymaster

“ABC” Dry Chemical Fire Extinguishers

ABC Dry Chemical Fire Extinguishers are suitable for use on Class A, Class B, and Class C fires. They are filled with fine yellow powders that put out the fire by coating the fuel with a thin layer of dust. Store in public areas such as offices, classrooms, churches, parking garages, and hotel/motel assembly halls and guest areas to safety put out fires.



CERTIFICATIONS

- UL/cUL Listed
- DOT Compliance
- USCG Approved

C&M PART #	MFG PART #	DESCRIPTION
110287	13315	Vehicle Bracket, 2-1/2 lb
110288	10914	Wall Mount, 5 lb
110289	11340	Wall Mount, 10 lb
110290	12120	Wall Mount, 20 lb

Vestil™ Floor Scraper & Brush Sweeper

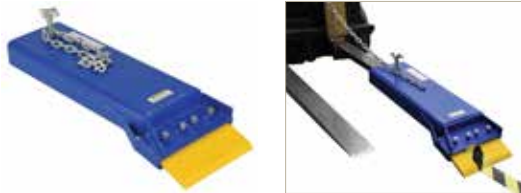

Turn your fork truck into a Floor Scraper. The scraper works well on paint and finish rooms for removing over sprayed paint from floors. Simply slide fork into opening and attach safety restraint to carriage ensuring safety. Hardened scraping blade provides long life and durability. Blade is mounted in pivot assembly to allow it to raise up with contact against a crack or rise in the floor. Heavy-duty welded steel construction with painted finish.

C&M PART #	MFG PART #	DESCRIPTION
111036	SCRAPE-1	Steel Fork Truck Floor Scraper, 12" Blade Width



The Fork Truck Brush Sweeper is ideal for interior and exterior commercial sweeping. Use for various cleanup applications such as cleaning docks, warehouses, and parking lots. Sweeper features a lightweight aluminum body with red powder-coat finish and polypropylene bristles. Attach sweeper by sliding forks into built-in pockets and securing with locking screws.

C&M PART #	MFG PART #	DESCRIPTION
111152	VSWP-60	Aluminum Fork Truck Mounted Sweeper, 60" Brush Width

Vestil™ Bag Lifter



Constructed of powder-coated steel for durability and added strength, the bag lifter is ideal for industrial and manufacturing settings. Use the lifter with the center mounted hook point for balanced lifting capabilities with an overhead hoist or with a forklift by utilizing the attached fork pockets (retaining strap included). After choosing which lifting style is best, secure the loops of the bag to the four strap points for safe maneuvering and transporting.

C&M PART #	MFG PART #	CAPACITY (lbs)	SAFETY STRAP	DIMENSIONS (L x W x H)
110662	BBL-4	4000	46"	39-15/16" x 53-1/2" x 10-9/16"



Vestil™ Hoppers



110736



110908



110974

Self-Dumping Light, Medium & Heavy-Duty Hoppers: These heavy-duty Self-Dumping Steel Hoppers feature a bumper that release automatically when bumper release contacts the front of the dumpster. Hopper returns to an upright and locked position automatically after it dumping.

Portable Hoppers: Portable Steel Hoppers make handling waste and bulk material safer and more convenient. Fork truck entry openings are designed to move hopper over rough terrain. Foot operated caster lock is included. Unit tilts with assistance from operator while seated on fork truck.

Low-Profile Parts Hoppers: These unique Low-Profile Parts Hoppers function as a parts hopper that may be dumped with the assistance of a fork truck. The low-profile design allows the hopper to be placed underneath machinery as a catch basin for parts. Hoppers roll smoothly on casters and include a removable push handle.

C&M PART #	MFG PART #	CAPACITY (lbs)	VOLUME (Cu Yds)
LIGHT-DUTY SELF DUMPING HOPPERS, 12 GAUGE STEEL			
110725	D-100-LD	2000	1
110731	D-200-LD	2000	2
MEDIUM-DUTY SELF DUMPING HOPPERS, 10 GAUGE STEEL			
110726	D-100-MD	4000	1
110732	D-200-MD	4000	2
110737	D-300-MD	4000	3
HEAVY-DUTY SELF DUMPING HOPPERS, 8 GAUGE STEEL			
110724	D-100-HD	6000	1
110730	D-200-HD	6000	2
110736	D-300-HD	6000	3
110738	D-400-HD	6000	4
110739	D-500-HD	6000	5
PORTABLE HOPPERS, 12 GAUGE STEEL			
110974	P-HOP-0.5	2000	0.5
110975	P-HOP-1	2000	1
110976	P-HOP-1.5	2000	1.5
LOW-PROFILE PARTS HOPPERS, 10 GAUGE STEEL			
110907	HOP-LP	2000	1/2
110908	HOP-LP-N	2000	1/3

Vestil™ Fork Extensions



Provide the extra support needed to lift long or large objects with a fork truck using a pair of Fork Extensions. Welded steel construction with cast steel tips provides the durability needed to handle larger loads. Steel retaining strap prevents fork extensions from sliding off forks during use. OSHA regulations require that extensions are no more than 150% of the existing fork length. To install, insert loop at the tip of the fork, slide it up at a 45-degree angle then lay it down over the existing fork. Use with Class 2 and Class 3 forks only.

C&M PART #	MFG PART #	CAPACITY (lbs)	LENGTH	WIDTH	COLOR
110777	FE-4-63	4000	63"	5-1/8"	Yellow
110778	FE-4-72	4000	72"	5-1/8"	Yellow
110779	FE-4-72-BK	4000	72"	5-1/8"	Black
110780	FE-4-84	4000	84"	5-1/8"	Yellow
110781	FE-4-96	4000	96"	5-1/8"	Yellow
110782	FE-5-63	5000	63"	6-1/8"	Yellow
110783	FE-5-72	5000	72"	6-1/8"	Yellow
110784	FE-5-84	5000	84"	6-1/8"	Yellow
110785	FE-5-96	5000	96"	6-1/8"	Yellow
110786	FE-6-72	6000	72"	7-1/8"	Yellow
110787	FE-6-96	6000	96"	7-1/8"	Yellow

Vestil™ Fork Extension Storage



Install or remove fork extensions without lifting, pushing, or getting off the fork truck with a Fork Extension Storage Rack. Simply drive in so tips of forks are over elevated bar, lower forks until they nest in channel in base of rack and back fork truck out of fork restraining straps. Fork extensions not included.

C&M PART #	MFG PART #	CAPACITY (lbs)	DIMENSIONS (L x W x H)
110813	FORK-R-54	400	45-3/4" x 40" x 54-3/16"

Vestil™ Work Platforms

These convenient fork truck Work Platforms quickly and safely raises maintenance personnel where they are needed. Simply insert forks into fork pockets of the platform. Fork locks secure platform to back of forks and a 36" long strap with hook attaches platform to fork truck. A maximum of two people can be in the work platform at one time.



FEATURES & BENEFITS

- Patented automatic locking gate with extra chain lock ensures maximum safety
- Treadplate floor provides a safe nonslip grip
- Dual handrails on three sides ensures worker safety

INCLUDES

Check floor plate

C&M PART #	MFG PART #	CAPACITY (lbs)	DIMENSIONS (L x W x H)
111156	WP-3636	1000	36" x 36" x 51"
111157	WP-3648	1000	48" x 36" x 51"
111158	WP-4848	1000	48" x 48" x 51"

STAY SAFE & PROTECTED



Head protection and worker visibility are important when working with fork trucks and work platforms in tight spaces.

Check out the **Safety** section for Head Protection on **pages 351-354** and Hi-Vis Apparel on **pages 362-371**.

Vestil™ Fork Truck Drum Carrier/Rotator



Easily transport and rotate steel drums using a fork truck with the Fork Truck Drum Carrier/Rotator. Rotate drum from the fork truck operator's seat using the included chains. Drum is held securely in place by a durable chain locking system. Drum must be full to rotate at rated capacity. Bung nut wrench is included for opening and closing drums.

C&M PART #	MFG PART #	CAPACITY (lbs)	DIMENSIONS (L x W x H)
110745	DCR-205-15	1500	48" x 40" x 26"

Vestil™ Lift Master Booms



Convenience and safety features are built into every Lift Master Boom. Unique design converts fork trucks into overhead lifting cranes. Durable structural steel construction creates a rugged and durable boom that will provide long service life. A safety restraint secures the boom to the fork truck for safe operation. Economy lift booms feature an infinitely adjustable locking screw; orbit lift booms feature a locking detent.

FEATURES & BENEFITS

- Fork pockets with safety strap attach and secure boom to fork truck
- Robotically welded construction provides precision and durability
- Operations and capacity sticker provide user instructions and safety

INCLUDES

Two lifting hooks

C&M PART #	MFG PART #	CAPACITY (lbs)
A STEEL ECONOMY TELESCOPING LIFT BOOM		
110936	LM-EBT-4-24	4000
110937	LM-EBT-6-24	6000
B STEEL ORBIT TELESCOPING LIFT BOOM		
110940	LM-OBT-4-24	4000
110941	LM-OBT-6-24	6000

Vestil™ Hoisting Hooks & Hitches



Steel Fork Truck Hook Base helps convert your fork truck into a tow truck for moving trailers and other portable equipment. Simple design slides onto forks and secures into place with pin style tine locks. Welded steel construction with powder coat blue finish offers durability.

Steel Fork Truck Hitch Attachment slides onto the fork lift forks and secure safety chain to fork lift. Once in place, the attachment is ready to be hitched to the desired equipment. A 56" long chain helps secure it to the fork lift.

Pintle Hook For Fork Truck Base is a type of towing hitch that is commonly used in heavy-duty applications, such as towing trailers or other heavy equipment. They are often used in industries like construction, agriculture, and military applications. It consists of a hook or loop that is mounted on a vehicle or machinery.

Steel Tow Balls and Hitches are essential components of a towing system used to connect a trailer to a vehicle. It is designed to provide a secure and safe connection between the towing vehicle and the trailer being towed.

Steel Double-Swivel Hoist Optioning Hook helps convert your fork truck into a hook with anchor in a matter of seconds. The easy-to-attach hoisting hook does not require the assistance of special tools. Secure to the fork truck using a long safety restraint and screw clamps. Zinc plated hook with shackle included.

Grab Hooks with Shackle are commonly used for lifting and securing heavy loads. A grab hook has a closed end with a narrow opening, allowing it to securely grab onto chains or other attachments. It is typically used to create a connection point for lifting or securing loads.

Steel Fork Truck Hook Plate Swivel enables any fork truck to safely lift a load using chains, cables or slings. Slanted fork openings prevent the hook plate from being used upside down. A hook with anchor shackle is included.

Steel Hoist Single Auto-Tension Swivel Hook converts your fork truck into a hook with anchor in a matter of seconds. The easy-to-attach hoisting hook does not require the assistance of special tools. The auto-tension hoisting hook offers a unique design and adds tension as weight is added. Secure to the fork truck using a long safety restraint and tine lock. Unit has baked-in powder-coated toughness. Hook with shackle included.

HITCHES

C&M PART #	MFG PART #	CAPACITY (lbs)	LENGTH	WIDTH	HEIGHT
A STEEL FORK TRUCK HOOK BASES					
110897	HOOK-BASE-32	4000	48"	40"	12"
110898	HOOK-BASE-38	4000	48"	40"	14"
110899	HOOK-BASE-44	4000	54"	40"	14"
B STEEL FORK TRUCK HITCH ATTACHMENT					
110816	FTTM-2	1500	20-9/16"	14-1/2"	8-1/16"
C PINTLE HOOK FOR FORK TRUCK BASE					
110903	PINTLE	N/A	7"	7"	5"
D STEEL TOW BALLS AND HITCHES					
110900	BALL-178	2000	1-7/8"	Bolt-On	7"
110901	BALL-200	5000	2"	Bolt-On	8"
110902	BALL-2516	5000	2-5/16"	Bolt-On	7"
110906	HITCH-3B	7500	1-7/8", 2" & 2-5/16"	Hitch Pin	12"

HOISTING HOOKS

C&M PART #	MFG PART #	CAPACITY (lbs)	LENGTH	WIDTH	HEIGHT
E STEEL DOUBLE-SWIVEL HOIST OPTIONING HOOKS					
110748	D-FORK-10-SL	10,000	24"	14"	5"
110749	D-FORK-4-SL	4000	72"	5-1/8"	2-5/16"
F GRAB HOOKS WITH SHACKLE					
110904	HOOK-R-4	4000	7"	5"	3"
110905	HOOK-S-6	6000	8"	7"	7"
G STEEL FORK TRUCK HOOKS PLATE SWIVEL					
110938	LM-HP4-S	4000	24"	11"	3"
110939	LM-HP6-S	6000	25"	13"	4"
H STEEL HOIST SINGLE AUTO TENSION SWIVEL HOOK					
111038	S-FORK-4-AT	4000	11"	8"	5"

Clarion® Food Grade A/W Machinery Oils



These Food Machinery A/W Oils meet the requirements of U.S. FDA regulation 21 CFR 178.3570 for lubricants with the possibility of incidental contact with food for human consumption. They are registered as NSF H1 lubricants for use in food processing plants under the jurisdiction of the USDA.

CERTIFICATIONS

- NSF/ANSI Standards 60 and 61

C&M PART #	MFG PART #	ISO GRADE	SIZE
401839Z750	633541009004	32	5 Gallon Pail
401839Z751	633541009001	32	55 Gallon Drum
401839BZ50	633543009004	68	5 Gallon Pail
401839BZ51	633543009001	68	55 Gallon Drum

Clarion® Food Grade 200 & 350 White Mineral Oils

Food Grade White Oils are severely refined oils derived from petroleum base oils. These oils meet the requirements set forth in the U.S. FDA regulations 21 CFR 172.878 for contact with food for human consumption, and 21 CFR 178.3620 (a) for use as a component of nonfood articles intended for use in contact with food for human consumption.



These products meet the current standards of the National Formulary (NF) or US Pharmacopeia (USP) and is registered as 3H and H1 lubricants for direct and incidental food contact by NSF, for use in food plants under the jurisdiction of the USDA.

CERTIFICATIONS

- NSF/ANSI Standards 60 and 61

C&M PART #	MFG PART #	DESCRIPTION	SIZE
401840Z750	633512009004	Food Grade White Mineral Oil 200 (ISO 32)	5 Gallon Pail
401840Z751	633512009001	Food Grade White Mineral Oil 200 (ISO 32)	55 Gallon Drum
401840BZ50	633514009004	Food Grade White Mineral Oil 350 (ISO 68)	5 Gallon Pail
401840BZ51	633514009001	Food Grade White Mineral Oil 350 (ISO 68)	55 Gallon Drum

Clarion® Food Grade 220 Machinery Gear Oils

Food Machinery Gear Oils are designed specifically for use in food machinery worm gears, spur gears and valves. These oils are formulated with a high-purity, white mineral oil and additive system for food processing applications, and do not contain any natural products derived from animals, nuts or genetically modified organisms (GMOs).



Suitable for use where vegetarian and nut-free food is prepared, these oils meet the requirements of US Food and Drug Administration (US FDA) regulation 21 CFR 178.3570 for lubricants with the possibility of incidental contact with food for human consumption. They are registered as NSF H1 lubricants for use in food processing plants under the jurisdiction of the US Department of Agriculture (USDA).

CERTIFICATIONS

- NSF/ANSI Standards 60 and 61

C&M PART #	MFG PART #	SIZE
401841EN50	633546009004	5 Gallon Pail
401841EN51	633546009001	55 Gallon Drum

Clarion® Food Grade No. 2 Machinery Gear Grease

These Food Grade No. 2 Machinery Greases are formulated with high-quality food-grade mineral oils, premium thickeners and select additives for improved oxidation control, wear protection and resistance to water.



A variety of greases allows selection of the product that is suitable for each unique application. Select the anhydrous calcium thickened Machinery Grease No. 2 for moderate temperature applications. For applications with high temperature and high load, select the aluminum complex thickened Clarion Food Machinery Grease No. 2 HT/EP.

CERTIFICATIONS

- NSF/ANSI Standards 60 and 61

C&M PART #	MFG PART #	DESCRIPTION	SIZE
40184203	655699009115	Food Grade No. 2 Machinery Gear Grease	10/Cs (13 oz Cartridge)
40184206	655699009031	Food Grade No. 2 Machinery Gear Grease	35 lb Pail
40184304	655700009080	Food Grade No. 2 Machinery Gear Grease HT/EP	10/Cs (14 oz Cartridge)
40184306	655700009031	Food Grade No. 2 Machinery Gear Grease HT/EP	35 lb Pail



Chevron® Meropa® XL Gear Oil

Premium quality Meropa Gear Oils offer long lubricant life and excellent wear protection. They offer excellent load carrying capacity, water demulsibility, oxidation stability and corrosion protection.



C&M PART #	MFG PART #	ISO GRADE	SIZE
401844EN50	277411783	220	5 Gallon Pail
401844EN51	277411983	220	55 Gallon Drum
401844ES50	277412783	320	5 Gallon Pail
401844ES51	277413783	320	55 Gallon Drum
4018446B50	277412983	460	5 Gallon Pail
4018446B51	277413983	460	55 Gallon Drum
4018446C51	277416983	680	55 Gallon Drum

Chevron® Rando® HD Hydraulic Oils for Pumps

Rando HD Oils are designed to give robust protection to hydraulic pumps in mobile and stationary systems for wide operating conditions. Rando HD ISO 32, 46 or 68 are recommended for vane-, piston- or gear-type pumps, especially where pressures exceed 1000 psi and lightly loaded reciprocating compressors. Rando HD ISO 100, 150, 220 or 320 are recommended for applications where AGMA rust and oxidation inhibited oils are required, hydraulic equipment reduction gears where EP is not required and plain and antifriction bearings.



C&M PART #	MFG PART #	ISO GRADE	SIZE
401851Z750	273277448	32	5 Gallon Pail
401851Z751	273277981	32	55 Gallon Drum
401851Y50	273278448	46	5 Gallon Pail
401851Y51	273278981	46	55 Gallon Drum
401851BZ50	273279448	68	5 Gallon Pail
401851BZ51	273279981	68	55 Gallon Drum
401851DG50	273228448	100	5 Gallon Pail
401851DG51	273228981	100	55 Gallon Drum
401851ED50	273280448	150	5 Gallon Pail
401851ED51	273280981	150	55 Gallon Drum
401851EN50	273281448	220	5 Gallon Pail
401851EN51	273281981	220	55 Gallon Drum

Chevron® Cylinder Oil W for Gear Drives

Cylinder Oils W provide excellent metal wettability and are designed to meet the needs of emulsifying cylinder oils. The combination of oil emulsibility and metal wetting characteristics result in minimum oil consumption rates and maximum oil lubricity in the presence of wet steam or water. The metal wetting helps ensure an effective lubricant film on the cylinder walls and positions of steam pump, and also provides the oiliness properties which are extremely important in lubricating the sliding worm gear surfaces in worm drive gear cases.



C&M PART #	MFG PART #	ISO GRADE	SIZE
4018466B50	230330448	460	5 Gallon Pail
4018466B51	230330981	460	55 Gallon Drum
4018466C50	230329448	680	5 Gallon Pail
4018466C51	230329981	680	55 Gallon Drum

Chevron® Regal® R&O Oils for Pumps

Ashless, zinc-free Regal R&O Oils provide excellent thermal and oxidation stability. Oils have excellent demulsibility to ensure good lubricant film strength and minimal wear through quick water separation.

Oils ISO 32 through 150 are recommended for use in most electric motor bearings, air compressors, gears, hydroelectric turbines, steam turbines, marine turbines, and non-heavy duty hydraulic systems where OEM recommends R&O type oils.



CERTIFICATIONS

- ISO 150 and 220 meet ANSI/AGMA 9005-F16-RO requirements, DIN 51517/2 CL requirements and MORGOIL Advanced specifications

C&M PART #	MFG PART #	ISO GRADE	SIZE
401850Z750	273209448	32	5 Gallon Pail
401850Z751	273209981	32	55 Gallon Drum
401850Y50	273210448	46	5 Gallon Pail
401850Y51	273210981	46	55 Gallon Drum
401850BZ50	273211448	68	5 Gallon Pail
401850BZ51	273211981	68	55 Gallon Drum
401850DG50	273212448	100	5 Gallon Pail
401850DG51	273212981	100	55 Gallon Drum
401850ED50	273204448	150	5 Gallon Pail
401850ED51	273204981	150	55 Gallon Drum
401850EN50	273205448	220	5 Gallon Pail
401850EN51	273205981	220	55 Gallon Drum

Chevron® GST® Oils

Ashless, zinc-free GST Oils provide exceptional oxidation stability, water separability and protection against rust and corrosion. Use these oils to meet the critical demands of nongear gas, steam and hydroelectric turbine bearing lubrication, reduction gear lubrication in marine operations as well as any other industrial applications where R&O type oils are recommended.



C&M PART #	MFG PART #	ISO GRADE	SIZE
401848Z750	253026448	32	5 Gallon Pail
401848Z751	253026981	32	55 Gallon Drum
4018485Y50	253027448	46	5 Gallon Pail
4018485Y51	253027981	46	55 Gallon Drum
401848BZ50	253028448	68	5 Gallon Pail
401848BZ51	253028981	68	55 Gallon Drum
401848DG50	253029448	100	5 Gallon Pail
401848DG51	253029981	100	55 Gallon Drum

Chevron® Black Pearl® SRI 2 (fka SRI Grease 2)



Black Pearl SRI Grease 2 is a high temperature ball and roller bearing grease suitable for high-speed and high-temperature operations. It is formulated with highly refined base stocks, a modern ashless, organic polyurea thickener coupled with high-performance rust and oxidation.

Black Pearl® SRI Grease 2 passes the Static Bearing Rust Test, ASTM D5969, with 10% synthetic sea water. This is nearly 10 times the life expectancy when using conventional lithium greases. Under normal operating temperatures and conditions Black Pearl SRI Grease 2 can be used as a “Life Pack” lubricant in sealed bearings. On units where horsepower and load are considered high on the roller element bearing, EP grease should be employed. In these instances, Black Pearl Grease EP would be the grease of choice and is fully compatible to use with Black Pearl SRI Grease 2.

C&M PART #	MFG PART #	DESCRIPTION	SIZE
40185605	254521652	Black Pearl SRI 2 (fka SRI Grease 2)	10/Cs (14 oz Cartridge)
40185606	254521451	Black Pearl SRI 2 (fka SRI Grease 2)	35 lb Pail
40185601	254521873	Black Pearl SRI 2 (fka SRI Grease 2)	120 lb Drum

Chevron® Multifak® EP 2 Greases

Multipurpose Multifak EP (extreme pressure) Greases are suitable for use in many industrial grease applications. They are manufactured using selected highly refined medium-viscosity index base oils, a lithium 12 hydroxy stearate thickener, an extreme pressure additive and rust and oxidation inhibitors. Multifak EP greases have high load carrying capacity and provide good protection of lubricated parts against wear. They provide good lubrication in the presence of water, protect bearing surfaces against corrosion and have excellent resistance to oxidation, which supports long life in storage and in use.



C&M PART #	MFG PART #	DESCRIPTION	SIZE
40185305	274503652	Multifak EP 2 Grease	10/Cs (14 oz Cartridge)
40185306	274503783	Multifak EP 2 Grease	35 lb Pail
40185301	274503875	Multifak EP 2 Grease	120 lb Drum

CITGO® EP Compound



Use EP Compounds for extra-duty industrial gear lubrication service where extreme pressure (EP) load conditions prevail. Recommended for lubrication of plain and antifriction bearings and gear drives that operate under extra heavy-duty conditions.

C&M PART #	MFG PART #	ISO GRADE	SIZE
40189506EN	631140001031	220	35 lb Pail
40189507EN	631140001027	220	400 lb Drum
40189506ES	631150001031	320	35 lb Pail
40189507ES	631150001027	320	400 lb Drum
401895066B	631170001031	460	35 lb Pail
401895076B	631170001027	460	400 lb Drum
401895076C	631180001027	680	400 lb Drum

CITGO® Pacemaker® Oils



Pacemaker Oils are rust and oxidation (R&O) inhibited general-purpose lubricants. These oils are made from high quality, paraffinic base stocks; their high viscosity index imparts superior temperature-viscosity characteristics. They are manufactured with high-viscosity index base stocks, contain anti-foam additives, and readily separate from water. Long service life in closed circulating systems is assured by low carbon-forming tendency and excellent resistance to oxidation, rusting and foaming.

C&M PART #	MFG PART #	ISO GRADE	SIZE
401849Z752	633715001169	32	3/Cs (1 Gallon Jug)
401849Z751	633715001001	32	55 Gallon Drum
4018495Y52	633720001169	46	3/Cs (1 Gallon Jug)
4018495Y51	633720001001	46	55 Gallon Drum
401849BZ52	633730001169	68	3/Cs (1 Gallon Jug)
401849BZ51	633730001001	68	55 Gallon Drum
4018495Z51	633745001001	115	55 Gallon Drum

CITGO® Cylinder Oils



Cylinder Oils are compounded lubricants designed for use in steam cylinders, gas compressor cylinders and worm gear drives. These oils are recommended for lubrication of steam cylinders over a wide range of operating conditions and steam quality. Use them lubricants for natural gas compressors having separate cylinder lubrication, especially where high-moisture natural gas is processed.

C&M PART #	MFG PART #	ISO GRADE	SIZE
4018475M51	635017001001	400-5	55 Gallon Drum
4018476C51	635023001001	680-7	55 Gallon Drum

CITGO® HyDurance® AW Fluids



HyDurance AW Fluids are formulated with high-quality base stocks and premium additive components. Specially formulated, superior anti-wear hydraulic and circulating oils offer excellent service in high-pressure, high-output industrial hydraulic circuits. They exhibit excellent protection and filterability and are chemically stable with excellent resistance to sludge formation.

C&M PART #	MFG PART #	ISO GRADE	SIZE
401852Z750	633607001004	32	5 Gallon Pail
401852Z751	633607001001	32	55 Gallon Drum
4018525Y50	633608001004	46	5 Gallon Pail
4018525Y51	633608001001	46	55 Gallon Drum
401852BZ50	633609001004	68	5 Gallon Pail
401852BZ51	633609001001	68	55 Gallon Drum
401852DG51	633610001001	100	55 Gallon Drum
401852ED51	633611001001	150	55 Gallon Drum

CITGO® Mystik® JT-6 Grease #2



Mystik JT-6 High Temp Grease #2 is a high-temperature, lithium-complex grease that combines excellent multipurpose properties with a high dropping point and low-temperature pumpability. It has a wide operating temperature range and provides superior protection in heavily loaded industrial, mining and construction applications.

Mystik JT-6 High Temp 3% Moly #2 Grease is a fully additive-treated, water insoluble and contains 3% molybdenum disulfide for extra protection under severe service conditions. It contains antirust, antiwear, extreme pressure and antioxidant additives.

C&M PART #	MFG PART #	DESCRIPTION	SIZE
40185405	665005002032	Mystik® JT-6 High Temp Grease #2	10/Cs (14 oz Cartridge)
40185406	665005002022	Mystik® JT-6 High Temp Grease #2	35 lb Pail
40185402	665005002072	Mystik® JT-6 High Temp Grease #2	120 lb Lined Keg
40185505	665056002032	Mystik® JT-6 HT 3% MOLY #2	10/Cs (14 oz Cartridge)
40185506	665056002044	Mystik® JT-6 HT 3% MOLY #2	35 lb Pail
40185502	665056002072	Mystik® JT-6 HT 3% MOLY #2	120 lb Lined Keg

Vestil™ Steel Folding Ladders with Wheels

The Folding Ladders with Wheels fold flat to save on storage space when ladders are not in use. Ladder folds after unlocking spring-loaded detent pin. Once unit is folded, tilt back on wheels for easy portability. Carbon steel ladders feature perforated steps for a nonslip surface.



FEATURES & BENEFITS

- Locking foldable design saves on storage space when not needed
- Perforated steps provide a nonslip surface
- Tilt back ladder design on wheels provides easy portability

SPECIFICATIONS

COLOR	Blue
CAPACITY	350 lb

CERTIFICATIONS

- Complies with ANSI 14.7 and OSHA 1910.29 specifications

C&M PART #	MFG PART #	DESCRIPTION
110795	FLAD-3	Three Steps, 23-3/4"W x 51-15/16"H x 26-1/2"D
110796	FLAD-4	Four Steps, 23-3/4"W x 61-9/16"H x 34-3/8"D

Vestil™ Polyethylene Step Stools



Easily get out-of-reach items using these Polyethylene Step Stools. They come with rubber feet and a nonskid tape surface. Hand holes make it easy for one person to transportation. Two- and three-step stools have rear opening access storage compartments.

SPECIFICATIONS

COLOR	Yellow
CAPACITY	500 lb

C&M PART #	MFG PART #	DESCRIPTION
111149	VST-1-Y	One Step, 19.5"W x 11-3/4"H x 13-3/4"D
111150	VST-2-Y	Two Steps, 21"W x 19.5"H x 24"D
111151	VST-3-Y	Three Steps, 21"W x 28-1/2"H x 34"D

Vestil™ Adjustable Leg-Height, Steel Step-Mate Stands



Independently adjustable height of the legs allows these Step-Mate Stands to be set to level on uneven floors. The legs adjust easily by screwing them into or out of the leg base. Use the stand as either a comfortable worker platform or a semi-permanent step. The serrated surface ensures safe footing. The unit has a welded construction. Welded steel construction offers ruggedness and durability.

FEATURES & BENEFITS

- Set to level on uneven floors using independently adjustable height legs
- Serrated step surface provides excellent traction—even in wet environments
- Each leg fitted with rubber tip for better grip and traction

SPECIFICATIONS

COLOR	Yellow
CAPACITY	500 lb

C&M PART #	MFG PART #	DIMENSIONS
110658	ASP-24	23-13/16"W x 15-1/4"H x 22-7/8"D
110659	ASP-36	36-3/16"W x 15-1/4"H x 22-7/8"D
110660	ASP-48	48-1/2"W x 15-1/4"H x 22-7/8"D

Vestil™ Steel Rolling Step Stools



The Rolling Step Stools are lightweight, convenient and easy to use. Spring loaded casters along with a rubber ring around the base provide the extra grip needed to stay in place when being used. Each step includes a nonslip rubber surface. Easily assembles without need for tools. Step stool measures 11-3/8" diameter at the top and 17" high.

SPECIFICATIONS

TOP STEP HEIGHT	17 in
CAPACITY	500 lb

C&M PART #	MFG PART #	COLOR
111059	STEP-17-BK	Black
111060	STEP-17-GY	Gray
111061	STEP-17-R	Red
111062	STEP-17-Y	Yellow



Scrubs In-A-Bucket Hand Cleaner Towels

Scrubs-in-a-Bucket Hand Cleaner Towels are premoistened wipes specifically designed for cleaning hands when water and soap are not readily available. These towels are often used in automotive, construction and manufacturing industries where workers need a convenient way to clean their hands from dirt, grease, oil or other stubborn substances. The towels are infused with cleaning agents, moisturizer and citrus fragrance to effectively remove grime while keeping the skin hydrated and smelling good.



C&M PART #	MFG PART #	TOWEL SIZE	COLOR	QUANTITY
108050	34744	10" x 12"	Blue	72/Bucket

Kimberly-Clark WypAll Wipers

WypAll Wipers are known for their durability and absorbency, making them suitable for a wide range of cleaning tasks. Use these wipers in industrial, healthcare, and foodservice settings, as well as for general household cleaning. They come in various sizes and types, including regular, heavy-duty and specialized wipes for different cleaning needs.



C&M PART #	MFG PART #	MODEL #	TYPE	COLOR	WIPER SIZE (L x W)	SHEETS
108077	138-06053	X50	Food Service	White	23.5" x 12.5"	200/Box
108078	138-41025	X80	Heavy-Duty Industrial	White	12.4" x 12.2"	475/Roll
108079	138-41455	X70	Medium-Duty Industrial	White	16.8" x 8.34"	100/Box
108086	412-34607	L20	Light-Duty Cleaning	White	16.8" x 12.5"	176/Box
108088	412-41043	X80	Heavy-Duty Industrial	Blue	12.4" x 12.2"	475/Roll
108089	412-41048	X80	Heavy-Duty Industrial	White	16.8" x 8.34"	80/Box

Kimberly-Clark Wall-Mount Bathroom Tissue Dispenser

Designed to hold and dispense bathroom tissues in commercial or public restroom settings, this Tissue Dispenser securely holds a jumbo-sized toilet paper roll, preventing them from falling or unraveling. Easily wall mount for a convenient and easily accessibility.



C&M PART #	MFG PART #	TYPE	UNIT SIZE (W x H x D)	COLOR
108087	412-34831	Tissue Dispenser	14.25" x 10.4" x 5.9"	Black

Kleenex® Hard Roll Paper Towels

Use these Hard Roll Paper Towels in high-traffic areas such as public restrooms, kitchens, and other commercial settings. They feel soft and feature absorbency pockets to maximize moisture absorption.



C&M PART #	MFG PART #	TYPE	CORE	DIAMETER	COLOR	QUANTITY
108091	412-50606	Hard Roll Paper Towels	1.75"	7.9"	White	600 ft/Roll

Scott Hand Paper Towel Rolls

Keep your hands dry and your work surfaces clean with these Hand Paper Towel Rolls. These paper towel rolls have excellent absorbency, strength and durability minimizing paper waste. Use the paper towel rolls with a dispenser for easy access and controlled dispensing. They are ideal for commercial kitchens, restrooms, healthcare facilities and other high-traffic areas where hand drying or cleaning is necessary.



C&M PART #	MFG PART #	TYPE	COLOR	QUANTITY
108083	KCP-01010	Essential Center Pull, Perforated	White	500 Sheets/Roll
108085	412-25702	Pro High-Capacity Hard Roll	White	1150-feet/Roll

Kleenex® 2-Ply Facial Tissue Junior Packs

The 2-Ply Junior Pack Facial Tissues are smaller in size compared to regular tissue boxes, making them a convenient and portable option for on-the-go use or for placing in smaller spaces. Each pack contains 65, 2-ply tissues that are soft, gentle and absorbent.



C&M PART #	MFG PART #	PLY	TOWEL SIZE (L x W)	TISSUES
108084	412-21195	2	5.5" x 8.4"	40/Box

Detex® Metal Detectable Scrub Pad

Safely use this tough, nonscratching scrub pad on any metal surface. The scrubbing pad is made of nylon fibers with iron and quartz abrasives. The highly visible metal detectable pad reduces the risk of recalls due to foreign matter contamination.



C&M PART #	MFG PART #	PAD SIZE	COLOR	QUANTITY
108051	34745	6" x 9"	Blue	1 Each

Kimtech Science™ Kimwipes™ Wipes

Kimwipes Wipes are excellent for light-duty laboratory and scientific usage. They are made from a blend of virgin wood pulp and synthetic fibers, which gives them a soft and absorbent texture. These low-lint and nonabrasive wipes are great for delicate tasks such as cleaning sensitive laboratory equipment, wiping down optics or handling delicate surfaces.



C&M PART #	MFG PART #	PLY	TOWEL SIZE (L x W)	QUANTITY
108044	34133	1	11.8" x 11.8"	196/Box
108045	34155	1	8.4" x 4.4"	280/Box
108046	34256	1	16.6" x 14.7"	140/Box
108047	34705	2	11.8" x 11.8"	119/Box
108048	34721	2	16.6" x 14.7"	90/Box
108049	34743	3	11.8" x 11.8"	119/Box

Warp Bros Trash Can Liners

Keep the waste bins clean and make the disposal of garbage more convenient by using these Trash Can Liners. The liners prevent the garbage from coming into direct contact with the inside of the trash can to help minimize odors, prevent leaks and make it easier to dispose of the waste without creating a mess.



C&M PART #	MFG PART #	CAPACITY (Gallon)	GAUGE (mil)	COLOR	QUANTITY
107988	BR24SM15	13	1.25	White	150/Box
107992	HB33-60	33	2.5	White	60/Box
107993	HB42-20	42	3	Black	20/Box
107989	FB55-50	55	1.75	White	50/Box
107994	HB-55-30	55	3	Black	30/Box
107995	HB55-30-R	55	3	Black	30/Roll

Core & Main Multipurpose Hand Towels

These waterless cleaners cut through the toughest tar, grease, wax, ink, paint, lubricants and adhesives. They are extremely versatile, and can be used for nearly any job, from cleaning tools, to wiping hands, to cleaning machinery and other surfaces.

FEATURES & BENEFITS

- Industrial strength yet gentle on skin
- Won't scratch surfaces or hands
- No rinsing needed, leaves no residue
- Citrus scent

CERTIFICATIONS

- NSF C1 authorized



C&M PART #	MFG PART #	DESCRIPTION
105058	15395020	20 Count Canister, 6 Canisters/Case
105059	15395003	70 Count Canister, 6 Canisters/Case

Warp Bros Flex-O-Bag Lawn & Leaf Bags



These Lawn & Leaf Bags are specifically designed for collecting and disposing of yard waste. They are larger and more durable than regular trash bags, allowing them to handle the bulk and weight of outdoor waste materials such as leaves, grass clippings, branches, and other organic debris.

C&M PART #	MFG PART #	SIZE	GAUGE (mil)	COLOR	QUANTITY
107990	FLB-612	33" x 48"	1.5	Black	12/Roll
107991	FLB-612-C	33" x 48"	1.5	Clear	12/Roll

Vestil™ Dock Chain Barrier System

The Dock Chain Barrier System is a visual barrier for keeping both personnel and products safe. The system consists of two bollards and two chains that span up to 10 ft long. A safety yellow finish ensures high visibility and a bolt on chain hook-up enables quick installation or removal. Chains are mounted at 21" and 39" high on the bollard. The chain can be cut to a specific size upon request.



INCLUDES

Two bollards, two 127" long chains and one bollard conversion kit; The conversion kit includes four bollard mounting brackets, 16 self-tapping sixteen screws, one post weldment bracket and four quick links

C&M PART #	MFG PART #	DESCRIPTION
110743	DCBB-42-4.5	Steel Dock Chain Barrier Bollard, 4.5" Diameter, Yellow

Vestil™ Pallet Pullers

The Pallet Pullers are used to pull pallets to the rear of trailers for easy fork truck access. Made of rugged steel construction. Heads are self-cleaning and unaffected by wood particles, paint or grease. Pallet pullers (11162 and 11163) provide single scissor action for wider jaw opening; pallet pullers (11164 and 11165) feature one piece curved heads with integral spurs for gripping pallet stringers. The Pallet puller is NOT designed for lifting.



C&M PART #	MFG PART #	CAPACITY (lbs)	JAW OPENING	COLOR
111162	PAL-12	5000	7"	Yellow
111163	PAL-16	6000	5"	Red
111164	PAL-21	5000	4"	Yellow
111165	PAL-LP	5000	3-1/4"	Yellow

Vestil™ Pry-Lever Bars

Use these Prylever Bars to get underneath heavy objects for transporting with fork truck, hand truck, or pallet truck. Thick steel nose plate with beveled edge and a long handle provide the leverage needed to make it easier to get under loads—ideal for dock workers, riggers and freight handlers.



C&M PART #	MFG PART #	CAPACITY (lbs)	LENGTH (ft)	MATERIAL	COLOR
111166	PLB/S-5	5000	5	Steel	Blue
111167	PLB/S-6	5000	6	Steel	Blue
111168	PLB-5	4250	5	Wood	Natural
111169	PLB-6	4250	6	Wood	Natural

Vestil™ Wheel Chock Holders



The Wheel Chock Holders keep wheel chocks safe and ready for use at any moment. Constructed of steel with yellow powder-coat finish for excellent visibility and durability. Easily mount to a designated surface using predrilled mounting holes.

C&M PART #	MFG PART #	DESCRIPTION
111172	WC-H	Steel Wheel Chock Holder with 11-1/4" Usable Width, 40 lb Capacity
111173	WC-H-R	Steel Wheel Chock Holder with 12-7/8" Usable Width, 40 lb Capacity

Vestil™ Aluminum Wheel Chocks with Handle

The Aluminum Wheel Chocks are ideal for maintenance and industrial facilities. Extruded lightweight aluminum construction makes these easy to handle. Each wheel choke features a serrated top to grip the tire and a triple edged bottom to grip the ground.



C&M PART #	MFG PART #	DESCRIPTION	DIMENSIONS (L x W x H)
111170	EALUM-7-H	Wheel Chock with Handle	11-7/8" x 17-1/16" x 37-9/16"
111171	EALUM-7-HS	Wheel Chock with Handle & Sign	11-7/8" x 21-3/16" x 37-9/16"

Vestil™ Plastic Utility Service Cart

Easily transport supplies using this Plastic Utility Service Cart. Made from structural foam plastic, this cart is lightweight yet very durable. Cart has two shelves with deep lips to prevent items from rolling off.



C&M PART #	MFG PART #	CAPACITY (lbs)	NO. OF SHELVES	DIMENSIONS (L x W x H)
110981	PLSC-2-2436	550	2	45" x 25-1/2" x 33-1/2"

Vestil™ Steel Mesh Carts



These Mesh Carts come with large pneumatic tires for easy maneuverability. Mesh sides and bottom ensure dirt and water drain through. Steel construction provides durability. Cart with the steel basket features fold down sides for easy loading and unloading. Tow coupler is standard.

C&M PART #	MFG PART #	CAPACITY (lbs)	BASKET MATERIAL	DIMENSIONS (L x W x H)
110951	LSC-2448-4SD	1000	Steel	53" x 24" x 26"
110952	LSC-3052-PCW	1000	Plastic	46-1/4" x 29-7/8" x 43-1/2"

Vestil™ Adjustable Tote Dolly



The unique design of the Adjustable Tote Dolly allows both width and length to be changed for use with different size totes. Simply loosen the screws and slide each side in or out to change the size. Welded steel construction with powder-coat blue finish offers maximum durability. Usable length is from 22 to 34"; usable width is from 16 to 24".

INCLUDES

Four swivel casters (two with brakes) that are attached with caster pads

C&M PART #	MFG PART #	CAPACITY (Lbs)	CASTER SIZE	DIMENSIONS (L x W x H)
110661	ATD-1622-6	3000	6"	36-1/2" x 26-1/2" x 8-7/8"

Vestil™ Specialty Dollies



Specialty Dollies are specialized types of wheeled platforms designed to assist in moving specific types of items. Each type of dolly has features that cater to the unique requirements of the objects being moved.

C&M PART #	MFG PART #	TYPE	CAPACITY (lbs)	DIMENSIONS (L x W x H)
110699	CARPET-45	Portable Carpet Dolly	500	61" x 26" x 20"
110754	DOL-1830-F	Poly Flush Top Dolly	1000	30" x 18" x 9"
110755	DOL-1830-P	Poly Padded Top Dolly	1000	30" x 18" x 9"
110979	PLDL-HD-4-10FF	HD Adjustable Panel Dolly	500	12" x 12-13/16" x 13-1/4"
110980	PLDL-LD-2-4PP	LD Door & Panel Dolly	350	10" x 6-15/16" x 9-9/16"
110927	LEG-D-12-4PK	Steel Leg Dolly (4 Pack)	300	10-3/4" x 12" x 2-3/4"
110928	LEG-D	Steel Leg Dolly	200	5-13/16" x 6-3/8" x 2-1/2"
110929	LEG-D-4PK	Steel Leg Dolly (4 Pack)	200	5-13/16" x 6-3/8" x 2-1/2"
110930	LEG-D-12	Steel Leg Dolly	300	10-3/4" x 12" x 2-3/4"

Vestil™ Hand Trucks



Hand Trucks, also known as dolly carts or sack trucks, make it easier to transport heavy or bulky items. They consist of a frame with wheels, handles and load platform to help easily maneuver and transport loads that would otherwise be difficult to carry manually. They are commonly used in warehouses, delivery services, moving companies and other industries where heavy lifting is required.

C&M PART #	MFG PART #	TYPE	CAPACITY (lbs)	DIMENSIONS (L x W x H)
110655	APPL-1200-60	Ratchet Appliance Cart	1200	17" x 24" x 60"
110656	APPL-1200-66	Ratchet Appliance Cart	1200	17" x 24" x 66"
110657	APPL-1200-72	Ratchet Appliance Cart	1200	17" x 24" x 72"
110753	DHHT-500S-HR	Dual Handle Hand Cart	500	17-1/2" x 21" x 44-1/2"
110790	FHC-150	Foldable Hand Truck	150	20" x 12" x 32"
111064	ST-TRUCK-300	Stair Hand Truck	300	11" x 25" x 49"
111102	TWC-600-DLX	Four Wheel Hand Truck	600	47" x 39" x 58"

Vestil™ Leveling Jacks & Top-Mount Floor Locks

Designed for permanent installation, these screw-style Leveling Jacks hold platforms and other equipment in place and stabilize them at the required height. Drill a 1-1/4" diameter hole through the platform to be leveled and bolt the platform between the upper and lower flanges of the jack's divided housing. Handle folds down when not in use. A slip-resistant rubber pad on the bottom keeps the base in place.



LEVELING JACKS

C&M PART #	MFG PART #	LIFT CAPACITY (lbs)	HOLDING CAPACITY (lbs)	HEIGHT	MATERIAL
110931	LJ-9	5000	10,000	18"	Steel
110932	LJ-9-SS	5000	10,000	18"	Stainless-Steel
110933	LJ-17	5000	10,000	26"	Steel
110934	LJ-17-SS	5000	10,000	26"	Stainless-Steel

Mount Floor Locks on platform trucks, fixture dollies or equipment with casters. Simple foot pressure immobilizes equipment. Locks when large friction face is pressed against the floor. To release, simply kick release rod. The brake is independent of casters and can be installed to any convenient location on the equipment. Vertical mounting plates are designed to mount to sides of carts and other portable products. The spring-loaded pad accommodates uneven floors. Units mount with pad 1" off the floor when retracted.



FLOOR LOCKS

C&M PART #	MFG PART #	RETRACTED/MOUNTING HEIGHT	FOR CASTER SIZE
110799	FL-LK-4E	4.875" to 5.625"	4"
110800	FL-LK-5EG	6" to 7"	5"
110802	FL-LK-6EL	6.5" to 7.25"	6"
110798	FL-LK-6EM	6.875" to 7.5"	6"
110804	FL-LK-8EL	8.75" to 9.5"	8"
110805	FL-LK-8EM	9.5" to 10.125"	8"
110803	FL-LK-8EH	9.625" to 10.5"	8"

Vestil™ Pallet Trucks



Use Pallet trucks to easily to lift and move pallets, They are commonly used in warehouses, distribution centers and other industrial settings where palletized goods need to be transported.

All-Terrain Pallet Trucks feature large wheels for movement over most surfaces. Strong welded tubular frame construction offers durability yet lightweight for easy handling.

Full-Featured Pallet Trucks have two articulating steering wheels and two front load rollers. Reinforced triple-formed steel forks provide twice the strength of standard single-formed forks. The spring-loaded handle automatically returns to vertical position when not in use.

Low-Profile Pallet Trucks are ideal for skids and low-profile pallets. Fingertip lever switch for raise, lower and neutral operation.

Mini-Hand Pallet Trucks feature short forks for easy maneuvering. It is lightweight for simple portability and compact enough to reduce storage space when not in use.

C&M PART #	MFG PART #	LIFT CAPACITY (lbs)	FORK LENGTH
A ALL-TERRAIN PALLET TRUCKS			
110651	ALL-T-2	2000	32"
110652	ALL-T-2-48	2000	48"
110653	ALL-T-HD	2500	32"
B FULL-FEATURED PALLET TRUCKS			
110989	PM4-2772	4000	72"
110990	PM4-2796	4000	96"
110992	PM5-2048	5500	48"
110993	PM5-2748	5500	48"
110994	PM5-2748-S	5500	48"
110995	PM5-2748-SFF	5500	48"
110996	PM5-2748-Y	5500	48"
C LOW-PROFILE PALLET TRUCKS			
110983	PM2-2044-SLP	2200	44"
110984	PM2-3344-SLP	2200	44"
110985	PM-2748-SCL-LP	5000	48"
110986	PM4-2048-LP	4000	48"
110987	PM4-2072	4400	72"
110988	PM4-2748-LP	4000	48"
110991	PM4-3348-LP	4000	48"
D MINI-HAND PALLET TRUCKS			
110982	PM1-1532-MINI	1100	32"
110997	PMC-PM5-2748	5500	48"

Vestil™ Platform Trucks

Easily and safely transport goods within a facility using Platform Trucks. They consist of a flat platform mounted on wheels, allowing for easy movement of heavy or bulky items. Aluminum models have a folding handle for easy storage.



C&M PART #	MFG PART #	CAPACITY (lbs)	PLATFORM SIZE	PLATFORM MATERIAL
110638	AFT-36-NM	600	24" x 36"	Aluminum
110639	AFT-48-NM	600	24" x 48"	Aluminum
110765	ECSPT-2448	2000	24" x 48"	Steel
110797	FLAT-C	2000	30" x 60"	Steel
111146	VHPT-2448	1600	24" x 48"	Hardwood

Vestil™ Steel Foldable Security Trucks

Foldable Security Trucks allow for easy storage and space-saving when not in use. All welded steel construction offers long lasting rugged use. Mesh walls allows easy viewing of contents. Easily transport trucks to where you need them—swivel casters with brakes ensure they don't roll away. Special door locking latch and padlock clasp (padlock not included) ensure safe storage of content.



C&M PART #	MFG PART #	TYPE	SHELVES	CAPACITY (lbs)	DIMENSIONS (L x W x H)
110815	FST-2744-2	Foldable Locking	2	2000	27" x 44" x 76-1/2"
111021	ROL-1834-3	Foldable/Nestable	3	990	18" x 34" x 59"

Vestil™ Stockpicker Truck

Stock Picker Truck combines the mobility of a cart with the versatility of a step ladder. When a person is standing on the ladder, spring-loaded steel step ladder holds the cart securely in place. The rubber tip of the ladder comes down to prevent the cart from moving while in use. Once the weight of the person is off the ladder, springs return the ladder to the raised position and the truck is ready to be moved. Standard shelves have a 2" lip turned up to prevent items from falling off.



C&M PART #	MFG PART #	TYPE	SHELVES	CAPACITY (lbs)	DIMENSIONS (L x W x H)
111048	SPS2-2848	Stock Picker	2	1000	51-3/4" x 27-7/8" x 50-1/8"

Vestil™ Tilt Truck



Tilt Trucks are ideal for transporting and dumping of bulk materials or waste. These trucks are commonly used in industries such as construction, manufacturing, hospitality, and waste management. Strong, one-piece molded polyethylene body with a steel base tip support and a balanced design to allow for simple dumping by one person. Easily portable on two large rubber wheels and two swivel wheels.

C&M PART #	MFG PART #	CAPACITY (lbs)	CUBIC YARD	COLOR
A LIGHT-DUTY TILT TRUCK				
111067	TDT-50-LD-BLACK	450	1/2	Black
111072	TDT-50-LD-BLUE	450	1/2	Blue
111073	TDT-50-LD-RED	450	1/2	Red
111074	TDT-50-LD-YELLOW	450	1/2	Yellow
111083	TDT-100-LD-BLACK	850	1	Black
111084	TDT-100-LD-BLUE	850	1	Blue
111086	TDT-100-LD-YELLOW	850	1	Yellow
B MEDIUM-DUTY TILT TRUCK				
111075	TDT-50-MD-BLACK	850	1/2	Black
111076	TDT-50-MD-BLUE	850	1/2	Blue
111078	TDT-50-MD-YELLOW	850	1/2	Yellow
111088	TDT-100-MD-BLUE	1250	1	Blue
111089	TDT-100-MD-RED	1250	1	Red
111090	TDT-100-MD-YELLOW	1250	1	Yellow
C HEAVY-DUTY TILT TRUCK				
111068	TDT-50-HD-BLACK	1400	1/2	Black
111069	TDT-50-HD-BLUE	1400	1/2	Blue
111071	TDT-50-HD-YELLOW	1400	1/2	Yellow
111079	TDT-100-HD-BLACK	2100	1	Black
111080	TDT-100-HD-BLUE	2100	1	Blue
111081	TDT-100-HD-RED	2100	1	Red

OZ Lifting Alumi-Lite® Davit Cranes

Constructed of lightweight aerospace-grade aluminum, these Lifting Alumi-Lite Davit Cranes are strong and truly portable. A smooth 360-degree rotation as well as three different boom height adjustments add versatility to the lifting operation. Assembly is simple, requiring only one person and no tools. Powder-coat finish provides excellent durability. The manual hand winch is DIN rated CE and includes a brake and power drill adapter.



Cranes do not come with base or cable assembly. The cranes use a modular base system to service multiple areas more easily; select from pedestal, socket or wall-mount bases. Cranes also require a cable assembly, choose from either galvanized or stainless steel and with or without a swaged ball. Cable assemblies with a swaged ball can only be used with a manual hand winch, cable assemblies without the swaged ball can be used with either manual hand or electric winches.

Davit cranes ship motor freight.

FEATURES & BENEFITS

- Lightweight aerospace-grade aluminum construction
- 360-degree rotation and three boom heights offer versatility
- Manual DIN rated CE winch
- Winch is included with purchase of crane

Load Ratings Based on Three Boom Height Adjustments and the Amount of Wire Rope:

LOAD RATINGS*	FIRST LAYER (lbs)	MID DRUM (lbs)	FULL DRUM (lbs)
500 lb Capacity Alumi-Lite Cranes; based on 3/16" wire rope			
POSITION 1 AT 0°	275	275	275
POSITION 2 AT +22.5°	330	330	330
POSITION 3 AT +45°	500	500	500
1000 lb Capacity Alumi-Lite Cranes; based on 1/4" wire rope or 3/16" Ultrax synthetic rope			
POSITION 1 AT 0°	550	550	550
POSITION 2 AT +22.5°	650	650	550
POSITION 3 AT +45°	1000	875	550

*Note: Load ratings shown are based on a manual winch. See page 146 for electric winch load ratings. Load ratings will vary depending on wire or synthetic rope and diameter. Dimensions are for reference only and can change without notice.

C&M PART #	MFG PART #	CAPACITY (lbs)	WINCH TYPE
401790FD03	OZA500DAV	500	Manual Hand Winch
401790FD01	OZA500DAV-ACW	500	110 VAC Electric Winch
401790FD02	OZA500DAV-DCW	500	12 VDC Electric Winch
401790FQ03	OZA1000DAV	1000	Manual Hand Winch
401790FQ01	OZA1000DAV-ACW	1000	110 VAC Electric Winch
401790FQ02	OZA1000DAV-DCW	1000	12 VDC Electric Winch

REPLACEMENT PARTS & ACCESSORIES

C&M PART #	MFG PART #	DESCRIPTION
401777	OZSOC3	Socket Base for 500 lb Capacity
401778	OZPED3	Pedestal Base for 500 lb Capacity
401779	OZWALL3	Wall-Mount Base for 500 lb Capacity
401787	OZSOC1-TP	Socket Base for 1000 lb Capacity
401788	OZPED1-TP	Pedestal Base for 1000 lb Capacity
401789	OZWALL1-TP	Wall-Mount Base for 1000 lb Capacity

OZ Lifting CompoZite® Davit Cranes



The CompoZite Davit Cranes are made of an advanced composite material, about 40% lighter than steel yet strong enough to lift up to 1200 pounds. Their light weight and ease of assembly and disassembly make them perfect for jobs where the crane has to be moved regularly.

The advanced composite material offers excellent corrosion resistance; all metal mil-spec zinc plated components provide corrosion resistance. Crane features 360-degree rotation on a smooth sleeve bearing and the external handle helps rotate crane when under load. The crane's boom has four different boom positions (see table below).

Cranes do not come with base or cable assembly. The cranes use a modular base system to service multiple areas more easily; select from pedestal, socket or wall-mount bases. Cranes also require a cable assembly, choose from either galvanized or stainless steel and with or without a swaged ball. Cable assemblies with a swaged ball can only be used with a manual hand winch, cable assemblies without the swaged ball can be used with either manual hand or electric winches.

Davit cranes ship motor freight.



FEATURES & BENEFITS

- Ratchet screw jack adjusts boom under load giving you infinite range of lift
- Easy one person setup does not require any tools
- DIN-rated hand winch equipped standard with a load holding weatherproof Weston brake (cable assembly sold separately)
- Quick connect winch handle with power drill adapter included
- Smart Latch technology at boom/mast connection
- Winch is included with purchase of crane

Load Ratings Based on Four Boom Positions and Amount of Rope:

LOAD RATINGS*	FIRST LAYER (lbs)	MID DRUM (lbs)	FULL DRUM (lbs)
Based on 1/4" wire rope or 3/16" Ulltex synthetic rope			
POSITION 1 AT 36"	1200	875	550
POSITION 2 AT 46"	900	875	550
POSITION 3 AT 56"	700	700	550
POSITION 4 AT 66"	400	400	400
Based on 3/16" wire rope			
POSITION 1 AT 36"	800	800	550
POSITION 2 AT 46"	800	800	550
POSITION 3 AT 56"	700	700	550
POSITION 4 AT 66"	400	400	400

*Note: Load ratings shown are based on a manual winch. See page 146 for electric winch load ratings. Load ratings will vary depending on wire or synthetic rope and diameter. Dimensions are for reference only and can change without notice.

C&M PART #	MFG PART #	WINCH TYPE
40176803	OZI200DAV	Manual Hand Winch
40176801	OZI200DAV-ACW	110 VAC Electric Winch
40176802	OZI200DAV-DCW	12 VDC Electric Winch

REPLACEMENT PARTS & ACCESSORIES

C&M PART #	MFG PART #	DESCRIPTION
401769	OZSOC1	Socket Base
401770	OZPED1	Pedestal Base
401771	OZWALL1	Wall-Mount Base

Local Knowledge
Local Experience
Local Service, Nationwide®

Count on Core & Main to provide a quality product assortment from trusted brands, access to industry and product experts, and best-in-class service.



OZ Lifting CompoZite Elite® Davit Cranes



The carbon fiber and high-strength aluminum construction of CompoZite Elite Davit Cranes make them not only lightweight but strong. Install permanently at a location or easily move from place to place. It only takes one person, and no tools, to assemble. Winch is included. The manual winch is DIN rated CE and includes a power drill adapter.

Cranes do not come with base or cable assembly. The cranes use a modular base system to service multiple areas more easily; select from pedestal, socket or wall-mount bases. Cranes also require a cable assembly, choose from either galvanized or stainless steel and with or without a swaged ball. Cable assemblies with a swaged ball can only be used with a manual hand winch, cable assemblies without the swaged ball can be used with either manual hand or electric winches.

Davit cranes ship motor freight.

FEATURES & BENEFITS

- Ultra-lightweight and portable
- Easy one person setup does not require any tools
- Corrosion-resistant finish withstands harsh environments
- Adjustable boom improves maneuverability
- Manual DIN rated CE winch
- Winch is included with purchase of crane

Load Ratings Based on Three Boom Positions and the Amount of Wire Rope:

LOAD RATINGS*	FIRST LAYER (lbs)	MID DRUM (lbs)	FULL DRUM (lbs)
Based on 1/4" wire rope or 3/16" Ultrax synthetic rope			
POSITION 1 AT 0°	500	500	500
POSITION 2 AT +22.5°	700	700	500
POSITION 3 AT +45°	1200	875	55

*Note: Load ratings shown are based on a manual winch. See page 146 for electric winch load ratings. Load ratings will vary depending on wire or synthetic rope and diameter. Dimensions are for reference only and can change without notice.

C&M PART #	MFG PART #	WINCH TYPE
40177203	OZCF1200DAV	Manual Hand Winch
40177201	OZCF1200DAV-ACW	110 VAC Electric Winch
40177202	OZCF1200DAV-DCW	12 VDC Electric Winch

REPLACEMENT PARTS & ACCESSORIES

C&M PART #	MFG PART #	DESCRIPTION
401773	OZSOC2	Socket Base
401774	OZPED2	Pedestal Base
401775	OZWALL2	Wall-Mount Base

OZ Lifting Steel Davit Cranes

These Lifting Steel Davit Cranes feature smooth 360-degree rotation and four different boom height adjustments for more versatile lifting operations. Steel construction with zinc plated finish provides excellent corrosion resistance even in harsh working environments. Crane winch is included. The manual winch is DIN rated CE and includes a power drill adapter.



Cranes do not come with base or cable assembly. The cranes use a modular base system to service multiple areas more easily; select from pedestal, socket or wall-mount bases. Cranes also require a cable assembly, choose from either galvanized or stainless steel and with or without a swaged ball. Cable assemblies with a swaged ball can only be used with a manual hand winch, cable assemblies without the swaged ball can be used with either manual hand or electric winches.

Davit cranes ship motor freight.

FEATURES & BENEFITS

- 360-degree rotation and four boom heights offer versatility
- Corrosion-resistant finish withstands harsh environments
- Manual DIN rated CE winch
- Winch is included with purchase of crane

Load Ratings Based on Crane Capacity and the Amount of Rope:

LOAD RATINGS	FIRST LAYER (lbs)	MID DRUM (lbs)	FULL DRUM (lbs)
Based on 3/16" wire rope			
500 LB CAPACITY CRANE	500	500	500
Based on 1/4" wire rope or 3/16" Ultrax synthetic rope			
1000 LB CAPACITY CRANE	1000	875	550
2500 LB CAPACITY CRANE	2500	2000	1550

*Note: Load ratings shown are based on a manual winch. See page 146 for electric winch load ratings. Load ratings will vary depending on wire or synthetic rope and diameter. Dimensions are for reference only and can change without notice.

C&M PART #	MFG PART #	CAPACITY (lbs)	WINCH TYPE
401776FD03	OZ500DAV	500	Manual Hand Winch
401776FD01	OZ500DAV-ACW	500	110 VAC Electric Winch
401776FD02	OZ500DAV-DCW	500	12 VDC Electric Winch
401776FQ03	OZ1000DAV	1000	Manual Hand Winch
401776FQ01	OZ1000DAV-ACW	1000	110 VAC Electric Winch
401776FQ02	OZ1000DAV-DCW	1000	12 VDC Electric Winch
401776FY03	OZ2500DAV	2500	Manual Hand Winch

REPLACEMENT PARTS & ACCESSORIES

C&M PART #	MFG PART #	DESCRIPTION
401777	OZSOC3	Socket Base for 500 lb Capacity
401780	OZSOC4	Socket Base for 1000 and 2500 lb Capacity
401778	OZPED3	Pedestal Base for 500 lb Capacity
401781	OZPED4	Pedestal Base for 1000 and 2500 lb Capacity
401779	OZWALL3	Wall-Mount Base for 500 lb Capacity
401782	OZWALL4	Wall-Mount Base for 1000 and 2500 lb Capacity



OZ Lifting Tele-Pro® Davit Cranes

The Tele-Pro® Davit Cranes differentiate themselves from other davit cranes with a telescoping boom that can be adjusted while under load. Use the winch handle or drill drive adapter to adjust the telescoping boom; ratchet screw jack adjusts the boom under load. Easily rotate crane 360 degrees on its smooth sleeve bearing. Zinc plated finish provides excellent corrosion resistance.



Cranes do not come with base or cable assembly. The cranes use a modular base system to service multiple areas more easily; select from pedestal, socket or wall-mount bases. Cranes also require a cable assembly, choose from either galvanized or stainless steel and with or without a swaged ball. Cable assemblies with a swaged ball can only be used with a manual hand winch, cable assemblies without the swaged ball can be used with either manual hand or electric winches.

Davit cranes ship motor freight.

FEATURES & BENEFITS

- Telescoping boom adjustment while under load
- 360-degree rotation for ease of use
- DIN-Rated hand winch equipped standard with a load holding, weatherproof Weston brake
- Quick connect winch handle with power drill adapter included
- Electric winch options available
- Smart Latch technology at boom/mast connection for easy assembly
- Winch is included with purchase of crane

C&M PART #	MFG PART #	CAPACITY (lbs)	WINCH TYPE
401783FD03	OZTP500DAV	500	Manual Hand Winch
401783FD01	OZTP500DAV-ACW	500	110 VAC Electric Winch
401783FD02	OZTP500DAV-DCW	500	12 VDC Electric Winch
4017836803	OZTP1200DAV	1200	Manual Hand Winch
4017836801	OZTP1200DAV-ACW	1200	110 VAC Electric Winch
4017836802	OZTP1200DAV-DCW	1200	12 VDC Electric Winch
401783FY03	OZTP2500DAV	2500	Manual Hand Winch

REPLACEMENT PARTS & ACCESSORIES

C&M PART #	MFG PART #	DESCRIPTION
401784	OZSOC2-TP	Socket Base for 500 lb Capacity
401785	OZPED2-TP	Pedestal Base for 500 lb Capacity
401786	OZWALL2-TP	Wall-Mount Base for 500 lb Capacity
401787	OZSOC1-TP	Socket Base for 1200 lb Capacity
401788	OZPED1-TP	Pedestal Base for 1200 lb Capacity
401789	OZWALL1-TP	Wall-Mount Base for 1200 lb Capacity
401780	OZSOC4	Socket Base for 2500 LB Capacity
401781	OZPED4	Pedestal Base for 2500 LB Capacity
401782	OZWALL4	Wall-Mount Base for 2500 LB Capacity

Load Ratings Based on Horizontal, 45° Boom Positions and the Amount of Wire Rope:

LOAD RATINGS*	FIRST LAYER (lbs)	MID DRUM (lbs)	FULL DRUM (lbs)
500 lb Capacity Cranes—Horizontal Boom Angle; based on 3/16" wire rope or Ultrex synthetic rope			
POSITION 1 AT 36"	500	500	500
POSITION 2 AT 46"	430	430	430
POSITION 3 AT 56"	350	350	350
POSITION 4 AT 66"	300	300	300
500 lb Capacity Cranes—45° Boom Angle; based on 3/16" wire rope or Ultrex synthetic rope			
POSITION 1 AT 23"	500	500	500
POSITION 2 AT 30"	500	500	500
POSITION 3 AT 37"	500	500	500
POSITION 4 AT 44"	450	450	450
1200 lb Capacity Cranes—Horizontal Boom Angle; based on 3/16" wire rope			
POSITION 1 AT 36"	800	800	550
POSITION 2 AT 46"	800	800	550
POSITION 3 AT 56"	750	750	550
POSITION 4 AT 66"	650	650	550
1200 lb Capacity Cranes—45° Boom Angle; based on 3/16" wire rope			
POSITION 1 AT 23"	800	800	550
POSITION 2 AT 30.25"	800	800	550
POSITION 3 AT 37.25"	800	800	550
POSITION 4 AT 44.5"	800	800	550
1200 lb Capacity Cranes—Horizontal Boom Angle; based on 1/4" wire rope or 3/16" Ultrex synthetic rope			
POSITION 1 AT 36"	1200	875	550
POSITION 2 AT 46"	900	875	550
POSITION 3 AT 56"	750	750	550
POSITION 4 AT 66"	650	650	550
1200 lb Capacity Cranes—45° Boom Angle; based on 1/4" wire rope or 3/16" Ultrex synthetic rope			
POSITION 1 AT 23"	1200	875	550
POSITION 2 AT 30.25"	1200	875	550
POSITION 3 AT 37.25"	1100	875	550
POSITION 4 AT 44.5"	950	875	550
2500 lb Capacity Cranes—Horizontal Boom Angle; based on 1/4" Ultrex synthetic rope			
POSITION 1 AT 46"	2000	2000	1550
POSITION 2 AT 58"	1900	1900	1550
POSITION 3 AT 70"	1600	1600	1550
POSITION 4 AT 82"	1300	1300	1300
2500 lb Capacity Cranes—45° Boom Angle; based on 1/4" Ultrex synthetic rope			
POSITION 1 AT 28"	2000	2000	1550
POSITION 2 AT 37"	2000	2000	1550
POSITION 3 AT 45.5"	2000	2000	1550
POSITION 4 AT 54"	2000	2000	1550
2500 lb Capacity Cranes—Horizontal Boom Angle; based on 3/8" Ultrex synthetic rope			
POSITION 1 AT 46"	2500	2015	1550
POSITION 2 AT 58"	1900	1900	1550
POSITION 3 AT 70"	1600	1600	1550
POSITION 4 AT 82"	1300	1300	1300
2500 lb Capacity Cranes—45° Boom Angle; based on 3/8" Ultrex synthetic rope			
POSITION 1 AT 28"	2500	2015	1550
POSITION 2 AT 37"	2500	2015	1550
POSITION 3 AT 45.5"	2500	2015	1550
POSITION 4 AT 54"	2000	2000	1550

*Note: Load ratings shown are based on a manual winch. See page 146 for electric winch load ratings. Load ratings will vary depending on wire or synthetic rope and diameter. Dimensions are for reference only and can change without notice.

OZ Lifting Steel Wire & Synthetic Rope Assemblies

Lifting Steel Wire and Synthetic Rope Assemblies come in various lengths and diameters. Steel wire ropes are available in galvanized steel or stainless steel. All steel wire rope assemblies come with a swivel hook with latch; some models also include a swaged ball. All synthetic rope assemblies are made from Ultrex and come with looped ends and pre-installed swivel hook with latch.

Power winches can only use wire rope assemblies that do not have a swaged ball, while manual winches can use wire ropes with or without the swaged ball. Keep your wire rope tensioned even when lowering the hook with no load with lifting headache ball (compatible with 3/16" and 1/4" wire rope assemblies.) Headache balls sold separately from all davit cranes and wire rope assemblies.



REPLACEMENT PARTS & ACCESSORIES

C&M PART #	MFG PART #	DESCRIPTION
401797	OZHB10	10 lb Headache Ball for use with 3/16" and 1/4" Wire Rope Assemblies

C&M PART #	MFG PART #	DIAMETER	MAX LENGTH (ft)
GALVANIZED CABLE ASSEMBLIES—SWAGED BALL AND SWIVEL HOOK WITH LATCH			
40179160N8	OZGAL.19-10B	3/16"	10
40179160V2	OZGAL.19-20B	3/16"	20
40179160Z1	OZGAL.19-30B	3/16"	30
40179160AL	OZGAL.19-40B	3/16"	40
40179160BC	OZGAL.19-50B	3/16"	50
40179160BR	OZGAL.19-60B	3/16"	60
40179160CB	OZGAL.19-70B	3/16"	70
40179160CM	OZGAL.19-80B	3/16"	80
40179111N8	OZGAL.25-10B	1/4"	10
40179111S2	OZGAL.25-15B	1/4"	15
40179111V2	OZGAL.25-20B	1/4"	20
40179111X2	OZGAL.25-25B	1/4"	25
40179111Z1	OZGAL.25-30B	1/4"	30
40179111AC	OZGAL.25-35B	1/4"	35
40179111AL	OZGAL.25-40B	1/4"	40
40179111AU	OZGAL.25-45B	1/4"	45
40179111BC	OZGAL.25-50B	1/4"	50
40179111BJ	OZGAL.25-55B	1/4"	55
STAINLESS STEEL CABLE ASSEMBLIES—SWAGED BALL AND SWIVEL HOOK WITH LATCH			
40179260N8	OZSS.19-10B	3/16"	10
40179260V2	OZSS.19-20B	3/16"	20
40179260Z1	OZSS.19-30B	3/16"	30
40179260AL	OZSS.19-40B	3/16"	40
40179260BC	OZSS.19-50B	3/16"	50
40179260BR	OZSS.19-60B	3/16"	60
40179260CB	OZSS.19-70B	3/16"	70
40179260CM	OZSS.19-80B	3/16"	80

C&M PART #	MFG PART #	DIAMETER	MAX LENGTH (ft)
STAINLESS STEEL CABLE ASSEMBLIES—SWAGED BALL AND SWIVEL HOOK WITH LATCH (CONTINUED)			
40179211N8	OZSS.25-10B	1/4"	10
40179211S2	OZSS.25-15B	1/4"	15
40179211V2	OZSS.25-20B	1/4"	20
40179211X2	OZSS.25-25B	1/4"	25
40179211Z1	OZSS.25-30B	1/4"	30
40179211AC	OZSS.25-35B	1/4"	35
40179211AL	OZSS.25-40B	1/4"	40
40179211AU	OZSS.25-45B	1/4"	45
40179211BC	OZSS.25-50B	1/4"	50
40179211BJ	OZSS.25-55B	1/4"	55
GALVANIZED CABLE ASSEMBLIES—SWIVEL HOOK WITH LATCH			
40179360N8	OZGAL.19-10	3/16"	10
40179360V2	OZGAL.19-20	3/16"	20
40179360Z1	OZGAL.19-30	3/16"	30
40179360AL	OZGAL.19-40	3/16"	40
40179360BC	OZGAL.19-50	3/16"	50
40179360BR	OZGAL.19-60	3/16"	60
40179360CB	OZGAL.19-70	3/16"	70
40179360CM	OZGAL.19-80	3/16"	80
40179360CW	OZGAL.19-90	3/16"	90
40179311N8	OZGAL.25-10	1/4"	10
40179311S2	OZGAL.25-15	1/4"	15
40179311V2	OZGAL.25-20	1/4"	20
40179311X2	OZGAL.25-25	1/4"	25
40179311Z1	OZGAL.25-30	1/4"	30
40179311AC	OZGAL.25-35	1/4"	35
40179311AL	OZGAL.25-40	1/4"	40
40179311AU	OZGAL.25-45	1/4"	45

C&M PART #	MFG PART #	DIAMETER	MAX LENGTH (ft)
STAINLESS STEEL CABLE ASSEMBLIES—SWIVEL HOOK WITH LATCH			
40179460N8	OZSS.19-10	3/16"	10
40179460V2	OZSS.19-20	3/16"	20
40179460Z1	OZSS.19-30	3/16"	30
40179460AL	OZSS.19-40	3/16"	40
40179460BC	OZSS.19-50	3/16"	50
40179460BR	OZSS.19-60	3/16"	60
40179460CB	OZSS.19-70	3/16"	70
40179460CM	OZSS.19-80	3/16"	80
40179460CW	OZSS.19-90	3/16"	90
40179411N8	OZSS.25-10	1/4"	10
40179411S2	OZSS.25-15	1/4"	15
40179411V2	OZSS.25-20	1/4"	20
40179411X2	OZSS.25-25	1/4"	25
40179411Z1	OZSS.25-30	1/4"	30
40179411AC	OZSS.25-35	1/4"	35
40179411AL	OZSS.25-40	1/4"	40
40179411AU	OZSS.25-45	1/4"	45
ULTREX SYNTHETIC ROPE ASSEMBLIES—LOOPED ENDS AND STAINLESS STEEL SWIVEL HOOK WITH LATCH			
40179560S2	OZSR.19-15	3/16"	15
40179560BC	OZSR.19-50	3/16"	50
40179560CW	OZSR.19-90	3/16"	90
40179560DS	OZSR.19-120	3/16"	120
40179611BC	OZSR.25-50	1/4"	50
40179611CG	OZSR.25-75	1/4"	75
40179615AU	OZSR.31-45	5/16"	45

OZ Lifting Manual & Electric Winches

Use these economical Manual Winches for lifting, pulling or tensioning applications. They are compact and feature dual cable anchor point, automatic weatherproof Weston style load brake, multiple frame-mounting positions, a solid machined gear and high gear ratio. The drill drive adapter comes standard on stainless steel manual brake winches and carbon steel hand winches, and is an optional on the carbon steel brake winches. Left hand option is available for the stainless steel model, call us at (888) 885-2673 for more information.

Efficiently lift, pull or tension with an Electric Winch. The electric winches feature a two-braking system, mechanical and dynamic, is lightweight and easily bolts on to davit cranes. Gears are machine cut and hardened and are fully enclosed to protect from contamination or damage. Both AC and DC options are available, and both models offer 3 minutes of continuous use with a 15-minute cool down.



Winch Load Capacity Based on the Amount of Cable (Cable Not Included):

LOAD RATINGS	FIRST LAYER (lbs)	MID DRUM (lbs)	FULL DRUM (lbs)
Carbon Steel Brake Winches			
1000 LB CAPACITY WINCH	1000	750	500
1500 LB CAPACITY WINCH	1500	1250	750
2000 LB CAPACITY WINCH	2000	1500	1000
Stainless Steel Brake Winches			
1000 LB CAPACITY WINCH	1000	750	500
1500 LB CAPACITY WINCH	1500	1250	750
2000 LB CAPACITY WINCH	2000	1500	1000
Carbon Steel Hand Winches			
1200 LB CAPACITY WINCH	1200	875	550
2500 LB CAPACITY WINCH	2500	2000	1550
115 VAC Electric Winch			
WITH 3/16" DIAMETER WIRE ROPE	800	800	800
WITH 1/4" DIAMETER WIRE ROPE	1200	1120	850
12 VDC Electric Winch			
WITH 3/16" DIAMETER WIRE ROPE	800	800	800
WITH 1/4" DIAMETER WIRE ROPE	1200	1120	850

C&M PART #	MFG PART #	CAPACITY (lbs)	DESCRIPTION
401798FQ	OZI1000BW	1000	Carbon Steel Manual Brake Winch
401799FQ	OZI1000BWSS	1000	Stainless Steel Manual Brake Winch
40183668	OZWINHND1	1200	Carbon Steel Hand Winch
40180201	OZACW	1200	115 VAC Electric Winch
40180202	OZDCW	1200	12 VDC Electric Winch
401798FV	OZI1500BW	1500	Carbon Steel Manual Brake Winch
401799FV	OZI1500BWSS	1500	Stainless Steel Manual Brake Winch
401798FW	OZ2000BW	2000	Carbon Steel Manual Brake Winch
401799FW	OZ2000BWSS	2000	Stainless Steel Manual Brake Winch
401836FY	OZWINHND2	2500	Carbon Steel Hand Winch

REPLACEMENT PARTS & ACCESSORIES

C&M PART #	MFG PART #	DESCRIPTION
401800	OZ1BWDD	Drill Drive Adapter for 1000 lb Capacity Manual Brake Winches
401801	OZ152BWDD	Drill Drive Adapter for 1500 & 2000 lb Capacity Manual Brake Winches
401837	OZWINDDA1	Replacement Drill Drive Adapter for 1200 lb Capacity Hand Winches
401838	OZWINDDA2	Replacement Drill Drive Adapter for 2500 lb Capacity Hand Winches
401803	OZEWC	AC & DC Electric Winch Cover

Vestil™ Shop Crane Engine Hoist



This portable Shop Crane Engine Hoist is great for various lifting applications. Four heavy-duty casters (two fixed and two swivel) make it easy to transport the hoist to where you need it. The hoist features heavy-duty steel construction and a telescopic boom to give the operator multiple lifting heights and capacities. Raised and lowered the boom using a manual hydraulic hand pump. The high-capacity hydraulic cylinder provides fast lifting action and includes a large diameter ram to withstand angled loads when lifting.

C&M PART #	MFG PART #	UNIFORM CAPACITY (lbs)	UNIFORM CAPACITY REACH	LEG DESIGN	LEG LENGTH RANGE
110766	EHN-60-T	6000	51-7/8"	Telescopic	54-1/2 to 83-1/4"

Vestil™ Truck Jib Cranes



Winch Operated Truck Jib Cranes feature welded steel construction and are designed to be installed in a pick-up truck bed. Lift items from the ground to truck bed height, then rotate into the cargo area. Manual hydraulic hand pump pivots telescoping boom up and down. The manual cable winch lifts and lowers loads up to 500 pounds. Friction brake winch locks automatically when operator turns the handle counterclockwise to lower the load. The crane swivels on a 360-degree base and has a usable cable length of 24 feet. Units come with one fixed hook, one chain slot hook and one cable hook with latch.

Hitch-Mounted Truck Jib Crane is constructed of rugged, welded steel with a powder-coat black finish and is designed to easily mount to standard Class III or higher 2" receivers. No modifications to receiver or truck are required for installation and use. Install crane on either side of the truck; offset upright design does not restrict tailgate while installed. Use the crane for vertical lifting only—maximum uniform lifting capacity is 600 pounds. The manual hand brake winch has 15 feet of 3/16" diameter cable and includes the lifting hook.

C&M PART #	MFG PART #	DESCRIPTION
111159	WTJ-4	Winch Truck Jib Crane, Steel
111160	WTJ-4-G	Winch Truck Jib Crane, Galvanized Steel
111161	WTJ-HITCH	Hitch-Mounted Truck Jib Crane, Steel

Vestil™ Electric Powered Floor Crane

Quickly and easily move heavy loads using the Electric Powered Floor Cranes. Raise and lower loads with the push of a button and maneuver in and out of tight work environments, such as warehouses and trailers. The high-torque DC drive and lift motors easily handle heavy-duty jobs. Durable steel construction and heavy-duty rigid hook with safety latch provide a long, dependable service life.



The truck rolls smoothly on poly-on-steel steering and loading wheels. The ergonomic handle features an easy to operate throttle with infinite adjustment of forward and reverse speeds, controlled lift/lower controls, adjustable length legs, proprietary safety-enhancing emergency reverse function and horn.

When the proprietary safety-enhancing emergency reverse function is activated, the emergency reverse belly switch instantly

Vestil™ Gantry Cranes

The Industrial Steel Gantry Crane is designed for transporting and positioning materials along the beam's length. The solid steel construction will provide years of service, while the painted blue finish will keep the models protected from surface ware. The casters lock the rigging in 1 of 4 positions; you can set the wheels and push the gantry crane forward, back, left or right. Optional total locking casters are available that lock the rigging in any position and locks the wheel from rotating—call for ordering information.



Select from fixed- or adjustable-height gantry cranes. Fixed-height cranes are ideal when there is no need to change the overall height of the unit. Change the height available under the I-beam on the adjustable-height cranes to accommodate various applications. It requires assistance from fork truck or other overhead lifting device to set up.

CERTIFICATIONS

- OSHA 29 CFR 1910.179, ASME B30.17, ANSI Z535.4

C&M PART #	MFG PART #	CAPACITY (lbs)	DIMENSIONS (L x W x H)	UNDER I-BEAM USABLE HEIGHT	I-BEAM (H x W)	WEIGHT (lbs)
FIXED-HEIGHT GANTRY CRANES						
110791	FHS-2-10	2000	119-3/4" x 64-1/2" x 120"	120"	6" x 4"	625
110792	FHS-4-10	4000	119-3/4" x 65-1/2" x 121"	120"	8-1/8" x 4"	688
110793	FHS-6-15	6000	179-3/4" x 65-1/2" x 121"	120"	10-1/8" x 4"	955
ADJUSTABLE-HEIGHT GANTRY CRANES						
110640	AHS-4-10-12	4000	119-3/4" x 77-3/8" x 145"	90 to 144"	8-1/8" x 4"	764
110641	AHS-8-15-14	8000	179-3/4" x 88-1/2" x 169"	103 to 169"	10-1/8" x 4"	1093

reverses direction and moves the unit forward (and away from the operator) until the switch is released or after 1.5 seconds have elapsed. The built-in safety circuit will automatically disable the entire unit if the emergency reverse belly switch is activated for more than 1.5 seconds, after which the unit must be reset to return to normal operating conditions.

In addition to the emergency reverse function the electric floor crane also includes an electromagnetic disc brake with automatic dead-man feature that activates when the operator releases the handle. This crane is not recommended for use on inclined surfaces and no greater than 4 degrees on a declined surface.

INCLUDES

Integral battery charger, battery level gauge and emergency battery disconnect

C&M PART #	MFG PART #	RETRACTED UNIFORM CAPACITY (lbs)	RETRACTED LIFT RANGE	BATTERY EXTENDED UNIFORM CAPACITY (lbs)	MANUALLY EXTENDED UNIFORM CAPACITY (lbs)	EXTENDED LIFT RANGE
110771	EPFC-25	2500	44-1/4"	1300	600	94"

OZ Lifting Beam Clamps

Standard Beam Clamps have durable, baked-enamel paint protection, stainless steel ID tag and individual test certificate and serial number. Meets CE and ASME B30.16 standards.

Stainless Steel (SS) Beam Clamps are constructed with type 304 stainless steel for corrosion resistance. Clamps include a stainless steel ID tag, individual test certificate and serial number. Meets CE and ASME B30.16 standards.

Beam Clamps USA have a ROHS-compliant zinc plated finish for corrosion protection and permanent engraved load ratings. These units are made in the USA. Meets the ASME B30.16 standard.

Beam Clamps USA with Fall Protection has 310 pounds of fall protection and meets or exceeds OSHA 1926.502 and OSHA 1910.140 standards for fall protection. They also have a ROHS-compliant zinc plated finish for corrosion protection, secondary rod lock nut, permanent engraved load rating, individual test certificate and serial number. These units are made in the USA. Meets the ASME B30.16 standard.

FEATURES & BENEFITS

- Robust, all-steel fully welded construction
- Super-quick adjustment to fit most I-beams (see measurements below)

C&M PART #	MFG PART #	DESCRIPTION	SAFE WORKING LOAD (lbs)	ADJUSTABLE BEAM WIDTH	WEIGHT (lbs)
40182430	OZ1BC	Standard Beam Clamp	2000	2.95 to 9.05"	9
40182450	OZ2BC	Standard Beam Clamp	4000	2.95 to 9.05"	11
40182487	OZ3BC	Standard Beam Clamp	6000	3.15 to 12.60"	21
40180430	OZSS1BC	SS Beam Clamp	2000	2.95 to 9.05"	9
40180450	OZSS2BC	SS Beam Clamp	4000	2.95 to 9.05"	11
40183030	OZ1BCA	Beam Clamp USA	2000	3 to 9"	9
40183050	OZ2BCA	Beam Clamp USA	4000	3 to 9"	11
40183087	OZ3BCA	Beam Clamp USA	6000	3.5 to 13"	22
401830F9	OZ5BCA	Beam Clamp USA	10,000	3.5 to 13"	26
401830N8	OZ10BCA	Beam Clamp USA	20,000	3.5 to 13"	39
40182830	OZ1BCA-MR	Beam Clamp USA with Fall Protection	2000	3 to 9"	9
40182850	OZ2BCA-MR	Beam Clamp USA with Fall Protection	4000	3 to 9"	11
40182887	OZ3BCA-MR	Beam Clamp USA with Fall Protection	6000	3.5 to 13"	22
401828F9	OZ5BCA-MR	Beam Clamp USA with Fall Protection	10,000	3.5 to 13"	26
401828N8	OZ10BCA-MR	Beam Clamp USA with Fall Protection	20,000	3.5 to 13"	39

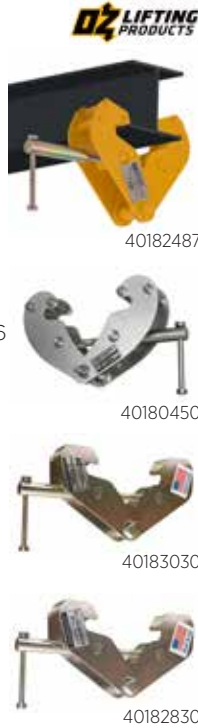

Vestil Clamps

The Vertical Positive Locking Plate Clamp grips a sheet until release ring is pulled. Serrated gripper is made of hardened tool steel; forged steel head and gear. Use the clamp to lift only one clean, oil-free plate at a time. Safety factor is 2 to 1. Not designed to use on stainless steel or aluminum plates. For use with materials with a surface hardness to 30 RC (300 HB).



FEATURES & BENEFITS

- Heavy-duty steel construction offers long lasting reliable use
- Unique design lifts plate material in a vertical position
- Locking mechanism offers maximum safety

CERTIFICATIONS

- ASME B30.20

C&M PART #	MFG PART #	CAPACITY (lbs)	DIMENSIONS (L x W x H)
110948	LPC-20	2000	5" x 3" x 10"
110949	LPC-40	4000	3-1/2" x 7-1/2" x 12"
110950	LPC-60	6000	8" x 4" x 15"

OZ Lifting Push Beam Trolleys

These lightweight, robust construction Lifting Push Beam Trolleys are ideal for multi-position applications. Standard push beam trolleys have durable baked enamel paint protection. Stainless steel (SS) push beam trolleys are made with type 304 stainless steel and offer enhanced corrosion resistance.



FEATURES & BENEFITS

- Fit most I-, S- and W-beams
- Precision ball bearing trolley wheels for smooth movement
- Anti-drop plate
- Stainless steel ID tag
- Individual test certificate and serial number

C&M PART #	MFG PART #	DESCRIPTION	CAPACITY (lbs)	ADJUSTABLE BEAM WIDTH	WEIGHT (lbs)
4018250A	OZ025PBT	Standard Push Beam Trolley	500	2 to 6"	7.7
4018250E	OZ05PBT	Standard Push Beam Trolley	1000	2.52 to 8"	12
40182530	OZ1PBT	Standard Push Beam Trolley	2000	2.52 to 8"	23
40182550	OZ2PBT	Standard Push Beam Trolley	4000	3.46 to 12"	40
40182587	OZ3PBT	Standard Push Beam Trolley	6000	4.33 to 12"	66
4018050A	OZSS025PBT	SS Push Beam Trolley	500	2 to 6"	7.7
4018050E	OZSS05PBT	SS Push Beam Trolley	1000	2.52 to 8"	13.9
40180530	OZSS1PBT	SS Push Beam Trolley	2000	2.52 to 8"	22.7
40180550	OZSS2PBT	SS Push Beam Trolley	4000	3.5 to 8"	39.7

OZ Lifting Push Beam Trolley USA



These Push Beam Trolleys USA have lightweight robust construction and are made in the USA. They feature ROHS-compliant zinc plated finish for corrosion protection. Fall protection models offer 310 pounds of fall protection and meets or exceeds OSHA 1926.502 and OSHA 1910.140 standards for fall protection.

FEATURES & BENEFITS

- Fast and easy width adjustments with no tools required
- Universal wheel tread fits most I-, S- and W-beams
- Precision ball bearing trolley wheels
- Glow in the dark decals
- Anti-drop plate
- Stainless steel ID tag
- Individual test certificate & serial number

C&M PART #	MFG PART #	CAPACITY (lbs)	FLANGE WIDTH	ADJUSTABLE BEAM WIDTH	WEIGHT (lbs)
PUSH BEAM TROLLEY USA					
401831LIOE	OZ05PBTA	1000	8"	2.52 to 8"	16
401831Q30E	OZ05PBTA-12	1000	12"	2.52 to 12"	19
401831S80E	OZ05PBTA-16	1000	16"	2.52 to 16"	20
401831L130	OZ1PBTA	2000	8"	2.75 to 8"	26
401831Q330	OZ1PBTA-12	2000	12"	2.75 to 12"	30
401831S830	OZ1PBTA-16	2000	16"	2.75 to 16"	31
401831L150	OZ2PBTA	4000	8"	3.75 to 8"	45
401831L187	OZ3PBTA	6000	8"	3.75 to 8"	80
PUSH BEAM TROLLEY USA WITH FALL PROTECTION					
401829L10E	OZ05PBTA-MR	1000	8"	2.52 to 8"	16
401829Q30E	OZ05PBTA-MR-12	1000	12"	2.52 to 12"	19
401829S80E	OZ05PBTA-MR-16	1000	16"	2.52 to 16"	20
401829L130	OZ1PBTA-MR	2000	8"	2.75 to 8"	26
401829Q330	OZ1PBTA-MR-12	2000	12"	2.75 to 12"	30
401829S830	OZ1PBTA-MR-16	2000	16"	2.75 to 16"	31

REPLACEMENT PARTS & ACCESSORIES

C&M PART #	MFG PART #	DESCRIPTION
401832	OZ05PBTA-12ROD/BAIL	12" Rod and Bail, only for 401831LIOE
401833	OZ05PBTA-16ROD/BAIL	16" Rod and Bail, only for 401831LIOE
401834	OZ1PBTA-12ROD/BAIL	12" Rod and Bail, only for 401831L130
401835	OZ1PBTA-16ROD/BAIL	16" Rod and Bail, only for 401831L130

OZ Lifting Geared Beam Trolleys



The Geared Beam Trolleys have lightweight, robust construction and durable baked enamel paint for protection. These trolleys feature gearing for positive load positioning. Zinc plated hand chain comes standard but stainless steel hand chains are available, call us at (888) 885-2673 for more information.

FEATURES & BENEFITS

- Fits most I-, S- and W-beams
- Precision ball bearing trolley wheels for smooth movement
- Anti-drop plate
- Stainless steel ID tag
- Individual test certificate and serial number

C&M PART #	MFG PART #	CAPACITY (lbs)	ADJUSTABLE BEAM WIDTH	WEIGHT (lbs)	EFFORT TO PULL (lbs)
40182630	OZ1GBT	2000	2.52 to 8"	29	10
40182650	OZ2GBT	4000	3.46 to 8"	42	18
40182687	OZ3GBT	6000	3.46 to 8"	62	29

OZ Lifting Quick Adjust Trolleys

Make a quick adjustment to fit most I, S or W beams. The Quick Adjust Trolleys are lightweight and feature robust construction, durable baked-enamel paint for protection and a safety handle lock. Simply spin the handle on the threaded adjustment rod to bring the sideplates together then tighten the locking handle in place.



FEATURES & BENEFITS

- Quickly adjust to fit most I-, S-, and W-beams
- Precision ball bearing trolley wheels
- Anti-drop plate
- Stainless steel ID tag
- Individual test certificate and serial number

CERTIFICATIONS

- ASME B30.11, ASME B30.16

C&M PART #	MFG PART #	CAPACITY (lbs)	ADJUSTABLE BEAM WIDTH	WEIGHT (lbs)
4018270E	OZ05QAT	1000	3.63 to 7.12"	13
40182730	OZ1QAT	2000	2.48 to 8.27"	25
40182750	OZ2QAT	4000	2.99 to 8.27"	38
40182787	OZ3QAT	6000	2.99 to 8.27"	57



Vestil™ Quick Install Manual Trolleys



The Quick Install Manual Trolleys adjust to the width of virtually any S, H, W and M type I-beam. Easily adjust the width using a manual screw mechanism which can also be tightened to lock trolley in place. The locking ring prevents the trolley width from accidentally changing during use. Use the lifting eye at the bottom of the trolley to attach a hoist (sold separately). Durable steel construction and rollers with sealed bearings provide longer service life.

C&M PART #	MFG PART #	UNIFORM CAPACITY (lbs)	FITS BEAM FLANGE WIDTH	WEIGHT (lbs)
111013	QIT-1	1000	3 to 5"	13
111014	QIT-2	2000	3 to 5"	14
111015	QIT-4	4000	3 to 7-1/2"	17
111016	QIT-6	6000	3 to 7-1/2"	43
111017	QIT-8	8000	4 to 11-3/4"	68

Vestil™ Push Eye Manual Trolleys



These Push Eye Manual Trolleys quickly install on virtually any S, H, W and M type I-beam. Easily adjust the width of the trolley by rotating the center rod with lifting eye clockwise or counterclockwise. Once the hoist (not included) is attached, the center rod cannot be rotated, preventing the trolley width from accidentally changing during use. Durable solid steel construction with a painted finish and rollers with sealed bearings provide long service life.

C&M PART #	MFG PART #	UNIFORM CAPACITY (lbs)	FITS BEAM FLANGE WIDTH	WEIGHT (lbs)
110767	E-MT-2	2000	2-1/2 to 10-1/8"	20
110768	E-MT-4	4000	2-1/2 to 8-5/8"	31
110769	E-MT-6	6000	3 to 8-5/8"	52
110770	E-MT-8	8000	3 to 9"	62

OZ Lifting Stainless Steel Chain Hoists

The Stainless Steel (SS) Chain Hoists are constructed of durable, corrosion-resistant type 304 SS. These hoists are versatile as they can be used for lifting or pulling. The hoists feature a unique hand wheel design that enables the hand chain to successfully feed directly into the wheel sprocket from many directions and angles reducing the risk of jamming. All gears and shafts run on sealed roller bearings that provide smooth, controlled operation of the gears and shafts, and provides maintenance-free lubrication. The forged SS hooks feature a heavy-duty SS safety latch with a bolt and lock nut connection for quick latch changing in the field. Hooks swivel 360 degrees for easy attachment and positioning. An enclosed and protected Weston-Style load brake stays clean and dry and feature a unique twin pawl design for additional reliability.



FEATURES & BENEFITS

- Minimal load lifting effort—ideal for frequent lifting and pulling applications
- Stainless steel hand and load chains provides a durable, non-oily finish
- Provided with food-grade grease that meets NSF-H1 standards
- Fully machined lift wheel for a smooth long-lasting operation
- Low headroom makes it ideal for restricted space applications
- Quickly disassemble for fast and easy maintenance
- Stainless steel ID tags

C&M PART #	MFG PART #	CAPACITY (lbs)	EFFORT TO LIFT SAFE WORKING LOAD (SWL)(lbs)	NET WEIGHT OF HEAD ONLY (lbs)	MAX LIFT (ft)
401806N80A	OZSS025-10CH	500	45	8.82	10
401806S20A	OZSS025-15CH	500	45	8.82	15
401806V20A	OZSS025-20CH	500	45	8.82	20
401806Z10A	OZSS025-30CH	500	45	8.82	30
401806N80E	OZSS005-10CH	1000	67	16.3	10
401806S20E	OZSS005-15CH	1000	67	16.3	15
401806V20E	OZSS005-20CH	1000	67	16.3	20
401806Z10E	OZSS005-30CH	1000	67	16.3	30
401806N830	OZSS010-10CH	2000	67	16.3	10
401806S230	OZSS010-15CH	2000	67	16.3	15
401806V230	OZSS010-20CH	2000	67	16.3	20
401806Z130	OZSS010-30CH	2000	67	16.3	30
401806N850	OZSS020-10CH	4000	74	22.9	10
401806S250	OZSS020-15CH	4000	74	22.9	15
401806V250	OZSS020-20CH	4000	74	22.9	20
401806Z150	OZSS020-30CH	4000	74	22.9	30



OZ Lifting Industrial & Premium Hoists

The Industrial and Premium Lever and Chain Hoists have an all-steel construction* with powder-coat finish, ensuring durable protection while providing a long and dependable service life in harsh environments. The double reduction gearing provides easy operation with minimal lifting effort. Weston-style brake system with a unique twin pawl design offers superior reliability. An enclosed and protected Weston-Style load brake stays clean and dry.

The hoists feature a unique hand wheel design that enables the hand chain to successfully feed directly into the wheel sprocket from many directions and angles reducing the risk of jamming. A sealed roller bearing provides smooth, controlled operation of the gears and shafts, and provides maintenance-free lubrication. The forged alloy hooks swivel 360 degrees for easier attachment and positioning. There is a thrust bearing on the lower hook which allows for easier rotation of the load while suspended and prevents chain twisting.

The Premium lever and chain hoists offer overload protection that prevents the operator from exceeding the limitations of the hoist. It is set at a minimum of 40% over the rated load, helping create a safer work environment.

*401820F90A and 401820N80A Industrial lever hoists are constructed of aluminum.

FEATURES & BENEFITS

- Long-lasting powder-coat finish
- Hooks swivel 360 degrees for easy attachment and positioning
- Enclosed gearing means gears are protected from contamination and debris
- Zinc plated chain provides a durable non-oily finish
- Individual test certificates and serial numbers

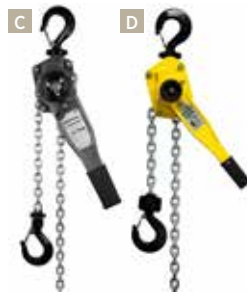

CERTIFICATIONS

- Lever hoists meet ANSI B30.21 standards and chain hoists meet ANSI B30.16 standards

C&M PART #	MFG PART #	CAPACITY (lbs)	EFFORT TO LIFT SAFE WORKING LOAD (SWL)(lbs)	NET WEIGHT OF HEAD ONLY (lbs)	MAX LIFT (ft)
B PREMIUM CHAIN HOISTS					
401823N80E	OZ005-10CHOP	1000	53	21	10
401823S20E	OZ005-15CHOP	1000	53	21	15
401823V20E	OZ005-20CHOP	1000	53	21	20
401823Z10E	OZ005-30CHOP	1000	53	21	30
401823N830	OZ010-10CHOP	2000	55	24	10
401823S230	OZ010-15CHOP	2000	55	24	15
401823V230	OZ010-20CHOP	2000	55	24	20
401823Z130	OZ010-30CHOP	2000	55	24	30
401823N80G	OZ015-10CHOP	3000	58	31	10
401823S20G	OZ015-15CHOP	3000	58	31	15
401823V20G	OZ015-20CHOP	3000	58	31	20
401823Z10G	OZ015-30CHOP	3000	58	31	30
401823N850	OZ020-10CHOP	4000	74	36	10
401823S250	OZ020-15CHOP	4000	74	36	15
401823V250	OZ020-20CHOP	4000	74	36	20
401823Z150	OZ020-30CHOP	4000	74	36	30
401823N887	OZ030-10CHOP	6000	58	41	10
401823S287	OZ030-15CHOP	6000	58	41	15
401823V287	OZ030-20CHOP	6000	58	41	20
401823Z187	OZ030-30CHOP	6000	58	41	30
C INDUSTRIAL LEVER HOIST					
401820F90A	OZIND025-5LH	500	44	4	5
401820N80A	OZIND025-10LH	500	44	4	10
401820F90F	OZIND075-5LH	1500	31.4	12	5
401820N80F	OZIND075-10LH	1500	31.4	12	10
401820S20F	OZIND075-15LH	1500	31.4	12	15
401820V20F	OZIND075-20LH	1500	31.4	12	20
401820F90G	OZIND150-5LH	3000	49.5	20	5
401820N80G	OZIND150-10LH	3000	49.5	20	10
401820S20G	OZIND150-15LH	3000	49.5	20	15
401820V20G	OZIND150-20LH	3000	49.5	20	20
401820F987	OZIND300-5LH	6000	72	36	5
401820N887	OZIND300-10LH	6000	72	36	10
401820S287	OZIND300-15LH	6000	72	36	15
401820V287	OZIND300-20LH	6000	72	36	20
D PREMIUM LEVER HOISTS					
401822F90F	OZ075-5LHOP	1500	30.86	13	5
401822N80F	OZ075-10LHOP	1500	30.86	13	10
401822S20F	OZ075-15LHOP	1500	30.86	13	15
401822V20F	OZ075-20LHOP	1500	30.86	13	20
401822F90G	OZ150-5LHOP	3000	48.50	22	5
401822N80G	OZ150-10LHOP	3000	48.50	22	10
401822S20G	OZ150-15LHOP	3000	48.50	22	15
401822V20G	OZ150-20LHOP	3000	48.50	22	20
401822F987	OZ300-5LHOP	6000	70.55	33	5
401822N887	OZ300-10LHOP	6000	70.55	33	10
401822S287	OZ300-15LHOP	6000	70.55	33	15
401822V287	OZ300-20LHOP	6000	70.55	33	20

C&M PART #	MFG PART #	CAPACITY (lbs)	EFFORT TO LIFT SAFE WORKING LOAD (SWL)(lbs)	NET WEIGHT OF HEAD ONLY (lbs)	MAX LIFT (ft)
A INDUSTRIAL CHAIN HOISTS					
401821N80A	OZIND025-10CH	500	55	4.7	10
401821N80E	OZIND005-10CH	1000	55	10.6	10
401821S20E	OZIND005-15CH	1000	55	10.6	15
401821V20E	OZIND005-20CH	1000	55	10.6	20
401821Z10E	OZIND005-30CH	1000	55	10.6	30
401821N830	OZIND010-10CH	2000	66	13.9	10
401821S230	OZIND010-15CH	2000	66	13.9	15
401821V230	OZIND010-20CH	2000	66	13.9	20
401821Z130	OZIND010-30CH	2000	66	13.9	30
401821N850	OZIND020-10CH	4000	88	22.7	10
401821S250	OZIND020-15CH	4000	88	22.7	15
401821V250	OZIND020-20CH	4000	88	22.7	20
401821Z150	OZIND020-30CH	4000	88	22.7	30
401821N887	OZIND030-10CH	6000	88	30	10
401821S287	OZIND030-15CH	6000	88	30	15
401821V287	OZIND030-20CH	6000	88	30	20
401821Z187	OZIND030-30CH	6000	88	30	30



OZ Lifting Electric Chain Hoists

Electric Chain Hoists with compact, lightweight cast aluminum alloy body and forged carbon steel load hook with heavy-duty latch are the perfect hoists for many workstation applications. Bottom hook with a thrust bearing allows for 360-degree rotation to prevent twisting of the load chain. A high-performance friction clutch integrated with the load brake provides overload protection. The load sheave offers better distribution of the load and smooth lifting with reduced vibration and wear. Heat-treated precision machined gears provide strength and durability. Oil bath lubrication on all bearing rotating points gives a quieter, smoother and cooler operation. Dual braking systems combine mechanical plus regenerative braking for instant and safe operation.



FEATURES & BENEFITS

- Grade 80 case-hardened alloy steel chain for long and dependable service life
- H3 duty class means 30% duty cycle for operation in various applications
- Standard 115 VAC/1A/60 Hz operation
- IP64 ergonomic pendant design for operator comfort
- Integrated emergency stop provides worker safety

INCLUDES

Vinyl chain bag

C&M PART #	MFG PART #	CAPACITY (lbs)	STANDARD LIFT (FT)	WEIGHT (lbs)	POWER CORD LENGTH (FT)	PENDANT LENGTH (FT)	DUTY CYCLE (MIN)
401807V20A	OZ500EC	500	20	18	15	15	15 (25%)
401807V20E	OZ1000EC	1000	20	53	15	19	18 (30%)
401807N830	OZ2000EC	2000	10	59	15	19	18 (30%)
401807N850	OZ4000EC	4000	10	84	15	19	18 (30%)

OZ Lifting Electric Builder's Hoists

Easily mount the lightweight and compact Builder's Hoists on a pipe or a wall. The galvanized wire rope has a 360 degree weighted hook that includes a safety latch. Achieve instant braking using the dynamic and mechanical brake. Upper and lower limit switches and an automatic shut-off when rope reached limit provide additional safety. A sensor arm for motor shut-off prevents reverse winding.

Select from various accessories to create a hoist that suits your application. Both pipe and wall mounting arm brackets have a powder-coat finish and are lightweight; reverse mount for low headroom situations. Combine the mounting arm brackets with a pipe or wall mounting kit to ensure proper installation.

Make your electric builder's hoist portable with a trolley. Choose from a standard push beam trolley with electric builder's hoist hanger 1, geared trolley with electric builder's hoist hanger 2 or standard push beam trolley with electric builder's hoist hanger 2.



REPLACEMENT PARTS & ACCESSORIES

C&M PART #	MFG PART #	DESCRIPTION
401809	OBH230	Mounting Arm Bracket (Pipe Mount), 1000 lb Capacity
401810	OBH230-WALL	Mounting Arm Bracket (Wall Mount), 1000 lb Capacity
401813	OBH230-PMK	Pipe-Mounting Kit, includes bracket, U-bolts, nuts and washers
401814	OBH230-WMK	Wall-Mounting Kit, includes wall-mount and mounting template
401817	OZ05PBTA-OBH	Push Beam Trolley with Integrated Hanger 1, up to 8" Flange Width, Made in the USA
401818	OZGBT-OBH	Geared Beam Trolley with Integrated Hanger 2
401819	OZPBT-OBH	Push Beam Trolley with Integrated Hanger 2
401811	OBH500-85	Replacement 98-ft Galvanized Wire Rope for OBH500
401812	OBH1000-85	Replacement 98-ft Galvanized Wire Rope for OBH1000
401815	OBH-CLAMP	Electric Builder's Hoist Beam Clamp, Made in the USA
401816	OBH-HANGER	Electric Builder's Hoist Hanger 1 for use with OZ05PBTA-OBH and OZGBT-OBH

FEATURES & BENEFITS

- Quick-release pendant and power cords
- Standard 115 VAC/60 Hz power source compatible
- Wireless plug and play adapter available
- Individual test certificate and serial number

SPECIFICATIONS

STANDARD LIFT (ft)	90
POWER CORD LENGTH (ft)	15
PENDANT LENGTH (ft)	65
DUTY CYCLE (MIN)	15 (25%)

C&M PART #	MFG PART #	CAPACITY—FULL DRUM (lbs)	WEIGHT (lbs)
401808CWOA	OBH500	500	54
401808CWOE	OBH1000	1000	73



Vestil™ Chain Hoist Push Trolleys

These low-headroom Chain Hoist Push Trolleys are ideal for use where space is tight. Use trolleys on wide flange or S-type I-beams. The chain hoist/trolley combination makes lifting and moving equipment safe and easy. The alloy steel load chain and galvanized carbon steel hand chain provide durability and long service life.



FEATURES & BENEFITS

- Compact design works well in locations where additional headroom is required
- Heavy-duty industrial steel construction provides long lasting use
- Chain hoist features 10 feet of vertical lift
- Bright orange color for visibility

C&M PART #	MFG PART #	UNIFORM CAPACITY (lbs)	FITS BEAM FLANGE WIDTH	WEIGHT (lbs)
110945	LOW-2P	2000	2-1/2 to 8"	63
110946	LOW-4P	4000	3-1/ to 8"	101
110947	LOW-6P	6000	4 to 8"	144

Vestil™ Spreader Beams

Lift and move uneven loads with the Adjustable Spreader Beam. is ideal for manufacturing and maintenance facilities. Adjust bails in 4" increments. The bails slide between two 5" high C-channels. Welded steel construction keeps the unit durable and strong for a lifetime of use. The beam is shipped with a test certificate.



FEATURES & BENEFITS

- Designed to lift and move uneven and awkward loads
- Includes two lower bails and one upper bail standard for added versatility

CERTIFICATIONS

- ASME B30.20-1993

C&M PART #	MFG PART #	CAPACITY (lbs)	DIMENSIONS (L x W x H)	SPREAD (Min/Max)	WEIGHT (lbs)
111030	SBM-25	2500	78" x 5" x 16-1/2"	8" / 72"	119
111031	SBM-40	4000	78" x 5" x 17-1/4"	8" / 72"	133

Vestil™ Magnetic Lifters



Pick up sheets of material using an overhead crane or chain with the permanent Magnetic Lifter. Activate or deactivate the magnet by rotating the lever. Units are lightweight, so transporting from work area to work area is simple and convenient.

FEATURES & BENEFITS

- Pick up sheets of material using an overhead crane or chain with magnetic lifter
- Simply activate or deactivate magnet by rotating a lever
- Lightweight magnetic lifter is easy to transport

HOLDING POWER TABLE

MIN. THICKNESS (in)	HOLDING POWER (%)	ACTUAL CAPACITY (lbs)
401204 – Nominal Capacity 220 lbs		
1/16	60	132
Up to 1/4	100	220
401205 – Nominal Capacity 660 lbs		
1/8	40	264
1/4	70	462
3/8 & Up	100	660
401206 – Nominal Capacity 1320 lbs		
1/8	20	264
1/4	40	528
3/8	60	792
5/8	85	1122
3/4	95	1254
1 & Up	100	1320

C&M PART #	MFG PART #	FLAT STEEL CAPACITY (lbs)	ROUND STEEL CAPACITY (lbs)	WEIGHT (lbs)
401204	ML-2	200	60	6
401205	ML-6	600	200	22
401206	ML-12	1200	400	52

HOW TO ORDER



ONLINE

supply.coreandmain.com



TELEPHONE

1-888-885-2673



EMAIL

support.supply@coreandmain.com

HOURS OF OPERATION: M-F; 6 A.M. to 7 P.M. CST

Highfield Manufacturing Barrel Locks & Accessories



Highfield Manufacturing is a manufacturer of user-friendly barrel locking and key configurations that provide a range of security levels for utility companies nationwide. Their innovative products combat meter tampering and prevent theft of service.

Barrel locks are resistant to picking due to the barrel's ability to turn freely in an encapsulated housing. There are two different types of keys that can unlock a barrel lock: a screw type key or a plunger type key. When either type key is placed in the keyway, the key clutches the barrel and releases the barrel's catch on the ball bearings located within the housing.

The **#4 Locking System** from Highfield provides an increased level of security above conventional barrel locks, with many styles to choose from, as well as barrel lock end caps sold separately.

The **#5 and #5A Locking Systems** feature a unique key and plunger design and offers increased security over conventional barrel locks. The #5 series and the #5A series have different styles to choose from. We offer replacement barrel lock end caps for the #5 and #5A series.

Please note the #5 and #5A keys are distinct and are not interchangeable.

The **#6 Locking System** provides a smooth plunger design and heavy spring for pick resistance, a perfect investment for utility security. In addition to optional stainless steel construction, this barrel lock and key system also meets the interchangeability requirements with other manufacturers' locks and keys. The #6 key can be used to open a #4 lock.

FEATURES & BENEFITS

- Barrel designed for added strength and durability
- Plated and case-hardened steel components for long life and corrosion protection

C&M PART #	MFG PART #	DESCRIPTION
#4 BARREL LOCK & KEY SYSTEM		
112115	93180100	#4 Barrel Lock with Cap
112116	93480130	#4 Regular Barrel Lock Key
112117	93480132	#4 Modified Barrel Lock Key
#5 & #5A BARREL LOCK & KEY SYSTEM		
112122	93180106	#5 Barrel Lock w/ Cap
112123	93480133	#5 Barrel Lock Key
112124	93180240	#5A Barrel Lock with Cap
112125	93480134	#5A Key
#6 BARREL LOCK & KEY SYSTEM		
112118	93180124	#6 Gold Barrel Lock with Cap
112119	93180128	#6 Stainless-Steel Barrel Lock with Cap
112120	93480136	#6 Advanced Barrel Lock Key
112121	93480136-EZY	#6 Barrel Lock EZY Key

REPLACEMENT PARTS & ACCESSORIES

C&M PART #	MFG PART #	DESCRIPTION
112128	93110116	Red Cap EC-10

SAVE TIME

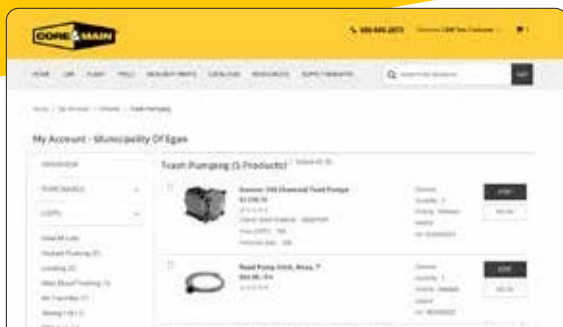

Create quick lists of your favorite products.
Organize items in job specific lists to streamline your ordering. Register for an account today at supply.coreandmain.com.

**TALK TO AN
EXPERT TODAY!**



Need application advice
or help to locate a part?

Contact our technical specialists,
they are here to help!

1-888-885-2673



**Master Lock® ProSeries® Weather Tough®
Keyed Alike Padlocks**



The Keyed Alike Padlocks allow multiple padlocks to be operated by the same key. They are ideal for when multiple padlocks are managed by one person. The ProSeries Weather Tough cover protects locks from water, ice, dirt and grime. Dual-ball locking mechanism resists pulling and prying for added security. Rekeyable, 5-pin cylinder with spool pins is virtually impossible to pick.

INCLUDES

Padlock and two keys

C&M PART #	MFG PART #	SHACKLE DIAMETER	SHACKLE LENGTH	BODY WIDTH
11121401	6125KA	3/8"	1-3/8"	2-3/8"
11121701	6127KA	7/16"	1-3/8"	2-5/8"

Master Lock® Commercial Keyed Alike

These Commercial Padlocks are typically built to withstand heavy-duty use, provide enhanced security, and offer features suitable for commercial environments. The Keyed Alike Padlocks allow multiple padlocks to be operated by the same key. They are ideal for when multiple padlocks are managed by one person. Dual-ball locking mechanism resists pulling and prying for added security. Nonrekeyable, 4-pin cylinder helps prevent picking.



INCLUDES

Padlock and two keys

C&M PART #	MFG PART #	SHACKLE DIAMETER	SHACKLE LENGTH	BODY WIDTH
11120501	3KA	9/32"	3/4"	1-9/16"
11120801	3KALF	9/32"	1-1/2"	1-9/16"
11121101	3KALH	9/32"	2"	1-9/16"
11119301	1KA	5/16"	15/16"	1-3/4"
11119601	1KALF	5/16"	1-1/2"	1-3/4"
11119901	1KALJ	5/16"	2-1/2"	1-3/4"
11120201	1KALN	5/16"	5-3/4"	1-3/4"
11118401	5KA	3/8"	1"	2"
11118701	5KALF	3/8"	1-1/2"	2"
11119001	5KALJ	3/8"	2-1/2"	2"



Master Lock® Zenex™ Thermoplastic Safety Padlocks

These red Dielectric Zenex Thermoplastic Padlocks provide electrical insulation to help prevent electrocution and arc flashing. All components are nonconductive—ideal for use in electrical and industrial settings where there is a risk of electrical hazards. These durable thermoplastic padlocks are lightweight, making them easy to carry around. Designed exclusively for Lockout/Tagout, padlocks have key retaining cylinder to ensure padlock is not left unlocked.



Select from three keying options. **Keyed Alike** padlocks in the set are opened by the same key so only one key is needed to open numerous padlocks. **Keyed Different** padlocks come with its own unique key which does not open any other padlock. **Mastered Keyed** padlocks come with individual keys for each padlock plus a master key that opens all padlocks in the set.

C&M PART #	MFG PART #	DESCRIPTION	SHACKLE DIAMETER	SHACKLE LENGTH	BODY WIDTH
11122301	406KARED	Keyed Alike	1/4"	1-1/2"	1-1/2"
11122302	406RED	Keyed Different	1/4"	1-1/2"	1-1/2"
11122303*	406MKRED	Master Keyed	1/4"	1-1/2"	1-1/2"

*Special Order

Master Lock® Laminated Utility Meter Padlocks

These specialized Utility Meter Padlocks are used to secure gas, water or electric meters. These commercial grade padlocks have laminated steel body and steel post to prevent unauthorized access to utility meters and protect against tampering or theft of services. Nonrekeyable, 4-pin cylinder helps prevent picking.



Select from three keying options. **Keyed Alike** padlocks in the set are opened by the same key so only one key is needed to open numerous padlocks. **Keyed Different** padlocks come with its own unique key which does not open any other padlock. **Mastered Keyed** padlocks come with individual keys for each padlock plus a master key that opens all padlocks in the set.

C&M PART #	MFG PART #	DESCRIPTION	SHACKLE DIAMETER	SHACKLE LENGTH	BODY WIDTH
11122601	443KA	Keyed Alike	3/8"	5/8"	1-9/16"
11122602	443	Keyed Different	3/8"	5/8"	1-9/16"
11122603*	443MK	Master Keyed	3/8"	7/8"	1-9/16"

*Special Order

Master Lock® Lockout Hasps



The Lockout Hasps, also known as safety hasps or lockout tagout hasps, are used in lockout/tagout procedures to provide a secure and visible means of isolating and locking out energy sources during maintenance or servicing of machinery or equipment. Hasps hold multiple padlocks, allowing multiple workers to apply their own individual locks, ensuring the equipment remain inoperative until all locks are removed.

C&M PART #	MFG PART #	COLOR	NO. OF PADLOCKS HELD	HASP LENGTH	SHACKLE DIAMETER ACCEPTED
1112292A	420	Red	6	4-1/2"	9/32"
1112292B	421	Red	6	5"	9/32"
111251A7	427	Red	5	7"	9/32"
11125119	427BLU	Blue	5	7"	9/32"
111251A0	427AST	Assorted	5	7"	9/32"

Master Lock® Padlock Stations



A Padlock Station is a centralized location where lockout/tagout devices and equipment are stored and organized. It serves as a visual and accessible hub for workers to retrieve and return lockout devices when performing maintenance or servicing tasks on machinery or equipment. Constructed of durable one-piece polycarbonate. Transparent lockable cover and snap-on clips provide for easy storage and selection.

C&M PART #	MFG PART #	LOCK TYPE	INCLUDES
111249	1482BP410	410RED Zenex	(4) Locks, (2) 420 Lockout Hasps and (12) 497A Safety Tags
111250	1483BP410	410RED Zenex	(10) Locks, (2) 420 Lockout Hasps and (24) 497A Safety Tags

Master Lock® Butterfly Valve Lockout



Use the Butterfly Valve Lockout to immobilize and secure butterfly valves in either the closed or open position during maintenance, repair or servicing work. The lockout device is designed to prevent the operation or movement of the butterfly valve, ensuring the safety of workers and preventing accidental release of hazardous materials. The durable, lightweight thermoplastic material is chemical resistant and withstands extreme environments.

C&M PART #	MFG PART #	DESCRIPTION
111248	S3920	Butterfly Valve Lockout, Device Only

Master Lock® Seal Tight™ Handle-On Ball Valve Lockout



The Seal Tight Ball Valve Lockout is used to immobilize and secure ball valves in either the closed or open position during maintenance, repair or servicing work. The lockout device is designed to clamp tight on the handle to prevent handle movement, preventing the operation or movement of the ball valve to ensure the safety of workers and accidental release of hazardous materials.

C&M PART #	MFG PART #	DESCRIPTION
111246	S3068	Seal Tight Handle-On Ball Valve Lockout

Master Lock® Adjustable Ball Valve Lockout



Use the Adjustable Ball Valve Lockout to immobilize and secure ball valves in either the closed or open position during maintenance, repair or servicing work. The lockout device is designed to prevent the operation or movement of the ball valve, ensuring the safety of workers and preventing accidental release of hazardous materials. The durable, lightweight thermoplastic material is chemical resistant and withstands extreme environments.

C&M PART #	MFG PART #	DESCRIPTION
111247	S3081	Adjustable Ball Valve Lockout, 1/2 to 2" Valves, Device Only

Master Lock® Lockout Stations



A Lockout Station is a designated area in a workplace where lockout/tagout equipment and procedures are centralized and organized. Lockout/tagout (LOTO) refers to a safety procedure used in industries and workplaces to ensure that hazardous energy sources are properly isolated and rendered inoperative before maintenance or repair work is performed on machinery or equipment.

C&M PART #	MFG PART #	DESCRIPTION
111240	S1850E410	Lockout Station, Electrical Focus, ZENEX™ Thermoplastic Padlocks
111241	S1850EPRE	Lockout Station w/Premier Electrical Device Assortment
111242	S1850E41OPRE	Lockout Station w/Premier Electrical Assortment, 6 Zenex™ Padlocks

Master Lock® Grip Tight™ Circuit Breaker Lockouts

The Grip Tight Circuit Breaker Lockouts are specifically designed for locking out circuit breakers. Locking out circuit breakers is an essential part of the lockout/tagout procedure to ensure the safety of workers performing maintenance or repair tasks on electrical systems. Simply adjust to breaker with a thumb turn and then close clamping handle for a tight grip on the toggle. Constructed of powder-coated steel and reinforced polymer for durability.

C&M PART #	MFG PART #	DESCRIPTION
111237	S3821	Miniature
111235GJ	493B	Standard Single and Double Toggles
111235SR	491B	Tall and Wide Toggles
111238	506	Lockout Set (One Each of 491B and 493B)



Master Lock® Rotating Gate Valve Lockouts

Place the Rotating Gate Valve Lockouts around the valve operating handle to secure gate valves and prevent unauthorized operation. A unique outward/inward rotating design allows for easy installation and removal, while providing a secure barrier to protect against accidental or intentional valve activation. Tough, lightweight, dielectric Zenex™ thermoplastic body has excellent chemical resistance. Remove center knockout to accommodate rising stem gate valves.



C&M PART #	MFG PART #	HANDLE DIAMETER
111243SS	480	1 to 3"
1112432N	481	2 to 5
111243ST	482	4 to 6-1/2"

Master Lock® Latch Tight™ Portable Group Lock Box

The Latch Tight Portable Group Lock Box is a lockout/tagout device used to enhance safety during maintenance, repair or servicing tasks where multiple workers are involved. Each authorized worker locks one personal safety padlock onto the box, removing it only when the his/her work is complete. The box accommodates up to 12 workers (more when used with lockout hasps). The exclusive Latch Tight feature ensures that keys cannot be accessed until the last padlock is removed.



C&M PART #	MFG PART #	DESCRIPTION
111239	498A	Latch Tight Portable Group Lock Box

Master Lock® Portable Lockout Kits



These Portable Lockout Toolboxes make it easy to keep important lockout devices and padlocks in one place. This toolbox helps ensure the safety of workers by preventing the accidental release of hazardous energy.

C&M PART #	MFG PART #	DESCRIPTION
111232	1457E410KA	Electrical Focus, Three ZENEX™ Padlocks
111233	1457V410KA	Valve Focus, Three ZENEX Padlocks
111234	1457VE410KAPRE	Valve & Electrical Focus, Four ZENEX Padlocks

Wooster® ACME Chip Paintbrushes

The ACME Chip Paintbrushes have white China bristles. Best used for applying varnishes, stains, roof coatings, glues & epoxies or for cleaning machinery, dusting away wood and metal chips.

C&M PART #	MFG PART #	BRUSH WIDTH
111386	F5117-1	1"
111387	F5117-2	2"
111388	F5117-3	3"
111389	F5117-4	4"



Wooster® Synthetic China Bristle Paintbrushes

The Synthetic China Bristle Paintbrushes are gray and have square trim. They can be used with all types of paints and has better capacity and performance than other economy brushes.

C&M PART #	MFG PART #	BRUSH WIDTH
111382	Z1101-1/2	1-1/2"
111383	Z1101-2	2"
111384	Z1101-3	3"
111385	Z1101-4	4"



Wooster® Amber Fong China Bristle Paintbrushes

The Amber Fong China Bristle Paintbrushes have soft, amber-brown bristles which provide a smooth finish with all oil-based enamels, varnishes and stains.

C&M PART #	MFG PART #	BRUSH WIDTH
111379	1123-2	2"
111380	1123-3	3"
111381	1123-4	4"

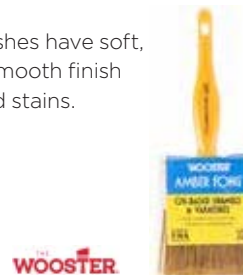

Wooster® Silver Tip Varnish Paintbrush

The Silver Tip Paintbrush provides great coverage. The soft blend of polyester virtually eliminates brush marks for the smoothest finish. Ideal for use in all paints and coatings.

C&M PART #	MFG PART #	BRUSH WIDTH
111378	5222-3	3"



Wooster® Sherlock Extension Poles



Easily extend your reach with the Sherlock Extension Poles. Rugged yet lightweight fiberglass outer pole offers durability; hexagonal anodized aluminum inner pole prevents twisting. Use the thumb lever to change the length of the pole in 6" increments. It adjusts easily and locks securely in place. The rugged, zinc die cast tip with universal threads holds tools securely.

C&M PART #	MFG PART #	EXTENSION LENGTH (ft)
111423	R054	2 to 4
111424	R055	4 to 8
111425	R056	6 to 12

Wooster® Non-Adjustable Extension Pole



The non-adjustable extension pole includes a red powder-coated steel rod, an anti-roll metal tip, universal thread and plastic grip. This product is made in the USA.

C&M PART #	MFG PART #	EXTENSION LENGTH
111426	R070-48	48"

Wooster® 1-Gallon Grid

Place the 1-Gallon Grid inside a 1-Gallon metal paint can and paint right from the can using a roller 4-1/2" or smaller. Two hooks help keep the grid at a slight tilt for easy use as well as keep grid securely in place. Durable, rust-proof polypropylene material resists solvents and paint build-up and is easy to clean.



C&M PART #	MFG PART #	DESCRIPTION
111415	R008	1-Gallon Grid

Wooster® Deluxe 5-Gallon Grid

The Deluxe 5-Gallon Grid is made from high-quality expanded steel wire with a bright galvanized finish. Use with 5-gallon paint buckets. Reinforced edges on all sides provide increased stability and durability.



C&M PART #	MFG PART #	DESCRIPTION
111411	F0001	Deluxe 5-Gallon Grid

Wooster® LockJaw® Tool Holder

The Lock Jaw Tool Holder is perfect for extending the reach of nonthreaded tools. It has a range of 160 degrees and locks in 9 positions, excellent even at odd angles. It withstands pressure from use and prevents slippage to keep tools in position.



FEATURES & BENEFITS

- Securely holds brushes, scrapers, flashlight and more
- Locks in 9 positions, range of 160 degrees—fully adjustable for virtually any angle
- Holds a maximum diameter of 1-3/8"
- Compatible with threaded or Sherlock GT® extension poles

C&M PART #	MFG PART #	DESCRIPTION
111422	F6333	LockJaw Tool Holder

Wooster® Jumbo-Koter® Super/Fab® Roller Covers

The Jumbo-Koter Super/Fab Roller Covers are the perfect choice for fast, complete coverage. Made of proprietary knit fabric, these are best suited for low-sheen applications—use with all flat or satin paints, stains or waterproofing.



C&M PART #	MFG PART #	DIMENSIONS	QTY
111420	RR300-4 1/2	4-1/2" L x 3/8" Nap	2/Pack
111421	RR300-6 1/2	6-1/2" L x 3/8" Nap	2/Pack

REPLACEMENT PARTS & ACCESSORIES

C&M PART #	MFG PART #	DESCRIPTION
111414	BR403-6 1/2	Tray, 6-1/2"
111416	RR013	Roller Frame

Wooster® Jumbo-Koter® Pro/Doo-Z® Roller Covers

The Jumbo-Koter Pro/Doo-Z Roller Covers consist of a shed-resistant fabric that will provide great results when used for any interior or exterior project. These covers can be used with all paints, enamels, primers, urethanes and epoxies.



C&M PART #	MFG PART #	DIMENSIONS	QTY
111418	RR302-4 1/2	4-1/2" L x 3/8" Nap	2/Pack
111419	RR302-6 1/2	6-1/2" L x 3/8" Nap	2/Pack

REPLACEMENT PARTS & ACCESSORIES

C&M PART #	MFG PART #	DESCRIPTION
111414	BR403-6.1.2	Tray, 6-1/2"
111416	RR013	Roller Frame

Wooster® Mohair Blend™ Roller Covers



The Mohair Blend Roller Covers are shed-resistant for all paints, enamels, urethans, epoxies and floor toppings. Naturally smooth painting qualities of mohair blended with added resiliency of polyester provides great coverage and durability.

C&M PART #	MFG PART #	DIMENSIONS
111406	R207-4	4" L x 1/4" Nap
111407	R207-9	9" x 1/4" Nap
111408	R207-18	18" x 1/4" Nap

Wooster® American Contractor® Roller Covers



The American Contractor Roller Covers have a shed-resistant knit fabric that provides fast pick-up and release, speeding up the application. Use the 1/2" nap covers for semi-rough surfaces; 3/4" nap covers for rough surfaces. Excellent for applying flat, eggshell and satin paints.

C&M PART #	MFG PART #	DIMENSIONS
111402	R563-9	9" L x 1/2" Nap
111403	R363-18	18" L x 1/2" Nap
111404	R564-9	9" L x 3/4" Nap
111405	R364-18	18" L x 3/4" Nap

Wooster® Painter's Solution Roller Covers



The Painter's Solution Roller Covers feature an exclusive shed-resistant woven fabric at an excellent price. These roller covers have a great pickup with controlled release and offer a smooth finish. Best used with paints, enamels, primers, urethanes and epoxies.

C&M PART #	MFG PART #	DIMENSIONS
111394	R575-9	9" L x 3/16" Nap
111395	R576-4	4" L x 3/8" Nap
111396	R576-9	9" L x 3/8" Nap
111397	R576-18	18" L x 3/8" Nap
111398	R577-9	9" L x 1/2" Nap
111399	R577-18	18" L x 1/2" Nap
111400	R578-4	4" L x 3/4" Nap
111401	R578-9	9" L x 3/4" Nap

Wooster® Roller Frames



A Jumbo-Koter® Pipe Painter: Paint pipes from 1 to 13" in diameter. Design incorporates two rollers, cutting painting time in half.

- Twin roller cages spin smoothly and paint two sides of a pipe simultaneously
- Fully adjustable to paint pipes, railings, posts and I-beams
- Galvanized 1/4" shanks, polypropylene threaded grip, Sherlock GT® compatible
- Works with both 4-1/2" and 6-1/2" Jumbo-Koter mini rollers

B Sherock® Mini PRO™ Roller Frame: Have confidence in your painting with a professional-grade mini cage frame. This unit also boasts a retaining spring that locks roller cover into place, allowing for hands free release.

- Pro grip handle
- Chrome-plated 1/4" shank
- Rolls smoothly, doesn't drag
- Compatible with Sherlock GT® and standard threaded extension poles

C Big Ben® Roller Frame: High-production, affordable 18" frame is constructed of lightweight yet strong polypropylene.

- Quickly install or remove the roller cover—no hardware to adjust, no tools required
- For use with all 18" rollers
- Compatible with Sherlock GT® and standard threaded extension poles

D Heavy-Duty Roller Frame: Sturdy five-wire cage with plastic endcaps and chrome-plated 5/16" shank frames.

- Plastic threaded grip for extension pole use

C&M PART #	MFG PART #	DESCRIPTION
111417	R212-4 1/2	Jumbo-Koter® Pipe Painter
111416	RR013	Sherock® Mini PRO™ Roller Frame
111393	BR045-18	Big Ben® Roller Frame
111392	F0010-9	9" Heavy-Duty Roller Frame
111391	F0010-4	4" Heavy-Duty Roller Frame

Wooster® Paint Trays



Paint trays help create a controlled and efficient workspace for painters. Paint trays feature sloped and/or textured surfaces as well as roll-off areas to help distribute paint evenly on the brush or roller. The shallow design helps reduce waste. Pair your paint tray with the appropriate liner to minimize required clean-up.

C&M PART #	MFG PART #	DESCRIPTION	WORKING CAPACITY (GAL)	MATERIAL
111412	BR412-21	21" Big Bend® Tray	1	Plastic
111409	R402-11	11" Metal Tray	1/4	Metal
111410	BR549-11	11" Plastic Tray	1/4	Plastic
111414	BR403-6 1/2	6-1/2" Jumbo-Koter® Tray	1/4	Plastic

REPLACEMENT PARTS & ACCESSORIES

C&M PART #	MFG PART #	DESCRIPTION	FOR USE WITH
111413	R478	21" Big Bend® Tray Liner	111412
111427	BR496-11	Tray Liner, 12-Pack	111409, 111410

Rust-Oleum® ROCAcrylic DTM Acrylic Enamel 3800 Coating

ROCAcrylic Direct-to-Metal (DTM) Enamel 3800 is a high-performance coating for interior or exterior use. This product is suitable for painting multiple surfaces, anywhere corrosion, adhesion, UV and impact resistance is required.

Note: Use may be restricted in geographic areas. Please ensure your compliance with local and state laws and regulations.

FEATURES & BENEFITS

- Fast drying, water-based formula
- Ultra-smooth, durable finish
- UV resistant for color and gloss retention
- Two-year Rust-Proof Guarantee*

C&M PART #	MFG PART #	COLOR
401571D5	314389	White
401571C7	315508	Dunes Tan
401571U1	315509	Forest Green
401571U2	314388	Navy Gray
401571F5	314209	Safety Blue
401571C1	314410	Safety Red
401571C2	314409	Safety Yellow
401571F7	315506	Silver Gray
401571I7	314387	Black



*Contact us for details, only valid if approved application method is followed and registration form is filled out, signed and submitted to the Rust-Oleum Technical Service Department within 30 days of project completion.

Rust-Oleum 9100 DTM Epoxy Mastic Paint

The High-Performance 9100 Direct-to-Metal (DTM) Epoxy Mastic Paint is a highly versatile, self-priming coating that provides a durable, chemical-resistant surface. Apply directly to sound rusted steel, galvanized metal, clean steel, concrete, and even slightly damp surfaces. It offers superior resistance to solvents, chemicals, abrasion and impact.

Note: Use may be restricted in geographic areas. Please ensure your compliance with local and state laws and regulations.

FEATURES & BENEFITS

- Direct-to-metal, self-priming coating provides durable resistance to abrasions, impact, solvents and chemicals
- 2-year rust-proof guarantee for a long-lasting finish
- Excellent adhesion to interior/exterior metal, steel, galvanized metal, concrete, masonry and other surfaces

C&M PART #	MFG PART #	COLOR
401596C2	9144402	Safety Yellow
401596U2	9186402	Navy Gray
401596I7	9179402	Black
401596D5	9192402	White
401596F7	9182402	Silver Gray
401596U3	9171402	Dunes Tan
401596C1	204006	Safety Red
401596F5	9125402	Safety Blue



REPLACEMENT PARTS & ACCESSORIES

C&M PART #	MFG PART #	DESCRIPTION
401595	9101402	Standard Activator Gloss Finish

Rust-Oleum® Universal Primer

The Commercial Grade Universal Alkyd Primer is a versatile, oil-based coating that adheres to most surfaces and is compatible with any topcoat. Use the primer in both interior and exterior surfaces where optimal surface prep is not possible. This direct-to-metal (DTM) primer also serves as a reliable stain sealer and blocker.

Note: Use may be restricted in geographic areas. Please ensure your compliance with local and state laws and regulations.

FEATURES & BENEFITS

- Excellent adhesion to dense, glossy surfaces such as enamel paints, laminates and ceramic tile
- Fast drying—recoat in less than 2 hours
- Flexible, high-hide, DTM formula
- Less than 340 g/L of VOC

C&M PART #	MFG PART #	COLOR
401593	302140	White
401594	330142	Gray



Rust-Oleum® THE MULE

The Modified Urethane Latex Epoxy (MULE) is a versatile, abrasion resistant coating that provides excellent adhesion on many surfaces. This water-based commercial paint formula contains a low-odor formula and is easy to clean with soap and water. It provides an ultra-smooth, highly washable, gloss finish when dry.

Note: Use may be restricted in geographic areas. Please ensure your compliance with local and state laws and regulations.

FEATURES & BENEFITS

- Provides rust prevention for indoor and outdoor surfaces
- Works on metal, wood, concrete, drywall, previously painted surfaces and brick
- Ideal for high traffic areas that experience routine cleaning and disinfecting
- VOC compliant nationwide



C&M PART #	MFG PART #	COLOR
40158017	375645	Black
401580F7	375642	Silver Gray
401580U3	381208	Dunes Tan
401580D5	375658	White
401580C2	375661	Safety Yellow

Rust-Oleum® V7400 Rust-Preventive Coating

The High-Performance V7400 Rust Preventive Direct-to-Metal Alkyd Enamel Paint provides premium rust protection for industrial applications including structural steel, general plant maintenance, machinery and equipment. This high solids, oil-based formula has a 2-year rust proof guarantee.

Note: Use may be restricted in geographic areas. Please ensure your compliance with local and state laws and regulations.

FEATURES & BENEFITS

- Provides rust prevention for indoor and outdoor surfaces
- One-coat coverage, even in safety colors
- Ultra-smooth finish that resists chipping, cracking, and other abrasions
- Withstands general weathering, mild chemical spills, oil, and grease



C&M PART #	MFG PART #	COLOR
40158517	245403	High Gloss Black
401585D5	245406	High Gloss White
401585U2	245443	High Gloss Navy Gray
401585F5	245474	High Gloss Safety Blue
401585C1	245478	High Gloss Safety Red
401585C2	245479	High Gloss Safety Yellow
401585U3	245382	High Gloss Dunes Tan
401585F7	245484	High Gloss Silver Gray

Core & Main Graffiti Wipes

Graffiti wipes are the most effective premoistened wipes available for removing paint and graffiti in one step. The powerful soy-based formula is environmentally safe and biodegradable. The abrasive but nonscratching fabric aids in cleaning. Use wipes on most nonporous surfaces, including bathroom partitions, aluminum siding, desks, phone booths, road signs, wall tile, lap posts, stainless steel, seats, billboards and lockers.



FEATURES & BENEFITS

- Highly effective against paint, enamel, ink and permanent marker
- Soy based formula, does not contain amyl acetate or methylene chloride

C&M PART #	MFG PART #	DESCRIPTION
105050	14475002	20 Count Canister, 6 Canisters/Case
105049	14475003	40 Count Canister, 6 Canisters/Case

Core & Main Rust Converters

Rust Converter instantly bonds with rust to stop its growth and transforms it into a nonrusting, paintable surface to prevent future rust formation. It provides an excellent primer coating for the application of quality oil-based paints. Surfaces protected with this converter and oil-based paint resist the effects of weather, rain, sun and salt spray and prevent peeling or cracking. This easy-to-use product is the first step in providing long-term protection of steel and iron surfaces.



Sprayable Convert & Aerosol Rust Converter is a liquid surface conditioner and primer that converts existing rust into an inert, protective coating that seals out moisture and corrosion. Unlike other products, it is not a simple cleaner or cover-up. The special formula attacks rust at the chemical level for fast, long-lasting results. Treated surfaces turn matte black and can be left as-is or painted with an oil-based paint for even longer protection against new rust.

C&M PART #	MFG PART #	DESCRIPTION
105054	3460041	Rust Converter, 1 Gallon, 4/Pack
105055	3460005	Rust Converter, 5 Gallon Pail
105052	3470041	Sprayable Convert, 1 Gallon, 4/Pack
105053	3470005	Sprayable Convert, 5 Gallon Pail
105051	8346	Aerosol Rust Converter, 13 oz Cans, 12/Pack

Core & Main Asphalt Patch

Fill cracks, potholes and fault lines using the Asphalt patch. This sealant is made from a mix of flexible yet resilient ingredients including screened aggregate, tar and asphalt binders to create a durable solution. It remains pliable within its container until application. Even when temperatures dip as low as -15°F and reach as high as 100°F, it remains loose enough for easy application, including in wet and dry weather conditions. Once it sets up, it keeps cracks sealed no matter how inclement the weather may get. Ideal for use on concrete, asphalt, black top, stone, brick roads, parking areas, playgrounds and driveways.



C&M PART #	MFG PART #	DESCRIPTION
401170	18010005	5 Gallon Pail

Vestil™ Barricade

Use the portable Barricade to manage traffic and crowds. Made of durable polyethylene, barricade weighs 37 lbs when empty; fill base with water or sand for added weight. A curved notch makes it easy to link multiple units to form a chain. The barriers have forklift slots on the bottom of the unit for easy transportation and can be stacked during storage for extra space. Special colors and custom mold in graphic labeling are available upon request.



C&M PART #	MFG PART #	DIMENSIONS (L x W x H)	MATERIAL	COLOR
110663	BCD-7636-OR	76-1/2" x 16" x 38"	Polyethylene	Orange

Vestil™ Folding Fabric Safety Barrier

The lightweight and portable three (3) section design Folding Fabric Barrier can be folded into various configurations. The barrier alerts people to hazards with the alert yellow/green fabric and SAFETY-FIRST marking. The fabric material is water and mildew resistant polyester. The Barrier is constructed of gray tubular plastic and folds flat for storage.



C&M PART #	MFG PART #	ASSEMBLED DIMENSIONS (L x W x H)	MATERIAL	COLOR
110776	FBR-3	69" x 1" x 38"	Polyester	Yellow

Vestil™ Steel Construction Safety Barrier Systems

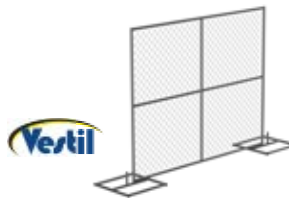

Use the Construction Safety Barrier to temporarily secure your job site from theft, hazard liability and dumping. Simply order the starter unit then as many add-on units as necessary. Panel section and base pieces are made from steel tubing. The chain link fence is secured to barrier with steel ties.

C&M PART #	MFG PART #	DESCRIPTION
110912	HRAIL-9072	Safety Barrier System
110913	HRAIL-A-9072	Safety Barrier Add-On Unit
110914	HRAIL-BASE	Safety Barrier Base
110915	HRAIL-CON	Safety Barrier Connector
110916	HRAIL-PNL	Safety Barrier Panel Unit

Vestil™ Safety Barriers



110956



111002



Use these Safety Barriers to close off areas and for crowd control. The mobile, plastic barrier folds easily and is held in closed position with black elastic cords. Simply tilt and roll on two 5" diameter wheels. The crowd control barriers interlock to an expanded length to easily direct personnel. Feet are removable so railing will lay flat for shipping and storage.

C&M PART #	MFG PART #	TYPE	LENGTH	MATERIAL	COLOR
110956	MSB-138	Mobile	40"	Plastic	Yellow
111001	PRAIL-102-G	Crowd Control	101-3/16"	Steel	Grey
111002	PRAIL-102-Y	Crowd Control	101-3/16"	Steel	Yellow
111003	PRAIL-102-HD-Y	Crowd Control	101-3/4"	Heavy-Duty Steel	Yellow



Vestil™ Safety Bollards



Safety Bollards are short, sturdy, vertical posts typically made of steel, concrete or plastic. They are commonly used to create a protective barrier, control vehicular or pedestrian traffic, and provide safety and security in various settings.

Decorative Bollards provide an attractive yet functional barrier to vehicle access and parking. All models have powder-coat black finish for appealing aesthetics. Use the eyes to attach chain or rope. Select from three different mounting models: surface, pour in place or removable underground. Removable bollard locks into galvanized steel socket that is cemented into the ground. When the bollard is removed, a cover plate protects the hole leaving no protrusion above the surface. A galvanized base is included with bollard. Padlock not included on all models.

Foldable Bollards are great for parking control and security as well as industrial and distribution facilities. Leave in the up position to prevent equipment or vehicles from entering the area; simply unlock and lower to allow for access. Model 110677 is locked in the raised position with a padlock (padlock not included). Base plate must be lagged to ground for proper installation (installation hardware not included). Model 110970 has an integrated lock and a cam-lock. Two wrap-around reflectors and four concrete anchors are included for securing bollard to concrete.

Pipe Bollards create barriers around workstations, machinery, and outdoor space. Combine these steel pipe bollards with chain slots to protect work areas and personnel. They are easy to assemble and ideal for indoor and outdoor applications. Bollards are constructed of heavy-duty welded steel with powder-coat safety yellow finish for excellent durability. The “BOL-XX” and “BOLPP” models come with a plastic removable cap; fill the bollards with concrete to increase its strength. The “BOL-JKS” models come with removable bolt-on steel top cap with socket set-screw; place chain in chain slot and store any excess chain inside the bollard. The “BOL-RF” Base plate on bolt-in and surface mount models include pre-drilled mounting holes.

Spring-Loaded Bollard will bend and not break like rigid bollards. Flexible spring bend in all directions and prevents damage to bollard and equipment. The bollard is manufactured from steel and includes a powder-coat safety yellow finish.

C&M PART #	MFG PART #	INSTALLATION	MATERIAL	COLOR	USABLE HEIGHT	DIAMETER
A DECORATIVE BOLLARDS						
110675	BOL-CI-38-8	Surface Mount	Ductile Iron	Black	38"	8"
110676	BOL-CI-40-8	Pour-in-Place	Ductile Iron	Black	40"	8"
110686	BOL-OR-40-BK	Underground Mount/Removable	Steel	Black	40"	4-1/2"
B FOLDABLE BOLLARDS						
110677	BOL-FD-36-Y	Bolt-in	Steel	Yellow	42"	1-11/16"
110970	PARK-P-108-FD	Bolt-in	Steel	Yellow	35-1/2"	7-1/2"
C PIPE BOLLARDS						
110666	BOL-24-4.5	Bolt-In	Steel	Yellow	24"	4-1/2"
110667	BOL-36-2	Bolt-in	Steel	Yellow	36"	1-3/4"
110668	BOL-36-4.5	Bolt-in	Steel	Yellow	36"	4-1/2"
110669	BOL-36-5.5	Bolt-in	Steel	Yellow	36"	5-1/2"
110670	BOL-42-2	Bolt-in	Steel	Yellow	42"	1-3/4"
110671	BOL-42-4.5	Bolt-in	Steel	Yellow	42"	4-1/2"
110672	BOL-42-5.5	Bolt-in	Steel	Yellow	42"	5-1/2"
110673	BOL-48-4.5	Bolt-in	Steel	Yellow	48"	4-1/2"
110674	BOL-48-5.5	Bolt-in	Steel	Yellow	48"	5-1/2"
110678	BOL-JKS-36-4.5	Bolt-in	Steel	Yellow	36"	4-1/2"
110679	BOL-JKS-42-4.5	Bolt-in	Steel	Yellow	42"	4-1/2"
110680	BOL-JKS-48-4.5	Bolt-in	Steel	Yellow	48"	4-1/2"
110681	BOL-JKS-48-5.5	Bolt-in	Steel	Yellow	48"	5-1/2"
110687	BOLPP-42-5.5	Pour-in-Place	Steel	Yellow	42"	5-1/2"
110688	BOLPP-48-5.5	Pour-in-Place	Steel	Yellow	48"	5-1/2"
110689	BOL-RF-36-4.5	Surface Mount/Removable	Steel	Yellow	36"	4-1/2"
110690	BOL-RF-42-4.5	Surface Mount/Removable	Steel	Yellow	42"	4-1/2"
110691	BOL-RF-48-4.5	Surface Mount/Removable	Steel	Yellow	48"	4-1/2"
110692	BOL-RF-48-5.5	Surface Mount/Removable	Steel	Yellow	48"	5-1/2"
110709	CBOL-42-4	Surface Mount	Steel	Chrome	42-1/8"	8"
110743	DCBB-42-4.5	Bolt-in	Steel	Yellow	42" (2)	4-1/2" (2)
SPRING-LOADED BOLLARD						
111041	SPBOL-42	Bolt-in	Steel	Yellow	42"	2-1/8"

FEATURES & BENEFITS

- Excellent for traffic management
- Provides perimeter security, property protection and pedestrian safety

REPLACEMENT PARTS & ACCESSORIES

C&M PART #	MFG PART #	DESCRIPTION
110682	BOL-JK-CN6	Galvanized Proof Coil Chain (Grade 30), 3/16" x 6 ft
110683	BOL-JK-CN15	Galvanized Proof Coil Chain (Grade 30), 3/16" x 15 ft
110684	AS-344	Steel Concrete Sleeve Anchor Bolt, 3/4" x 4" L, Silver, Each
110685	AS-344-4PK	Steel Concrete Sleeve Anchor Bolt, 3/4" x 4" L, Silver, 4/Pack

Vestil™ Safety Gates

Expand-A-Gates set up quickly and easily wherever and whenever they are needed. They are lightweight and have a smooth operating scissor action allowing fast set up to limit access to unsafe areas, preventing potential accidents. Interlock or nest for easy portability and storage. Models with casters come with rubber swivel casters.

Mezzanine Safety Gate provides an OSHA required handrail, mid-rail and kickplate for mezzanine without sacrificing load accessibility. To accommodate the maximum load height, when utilizing a standard pallet, load positioning within the gate is critical. For the greatest amount of clearance and item placement flexibility, shorter loads are recommended. The gate rotates and the design is balanced to allow for easy operation without the use of springs.

Self-Closing Gate allows customization your safety railings. Mount the gate from the left or right with the included mounting hardware to horizontal rails (railing and base not included.) Yellow powder-coat finish. Meets OSHA requirements.



C&M PART #	MFG PART #	DESCRIPTION	MATERIAL
110645	ALEXGATE-30-C	Expand-A-Gate with Casters, 144" Max Expanded Width	Aluminum
110973	PEXGATE-30	Expand-A-Gate, 122" Max Expanded Width	Plastic
110974	EXGATE-30	Expand-A-Gate, 144" Max Expanded Width	Steel
110975	EXGATE-30-C	Expand-A-Gate with Casters, 144" Max Expanded Width	Steel
110954	MEZZ-200	Mezzanine Safety Gate, 79-5/16" x 68-1/2" x 80-1/16"	Steel
111042	SPG-40-Y	Self-Closing Gate, 24 to 40" Opening	Steel

Vestil™ Gantry & Jib Guards

Prevent costly damage to steel columns, pipes and tubing from carts and fork trucks with this Gantry/Jib Guard. Thick solid steel design offers maximum strength to protect items from impact. Ideal for fixed jibs and gantry cranes. Mounting plate features six predrilled mounting holes.



C&M PART #	MFG PART #	ASSEMBLED DIMENSIONS (L x W x H)	MATERIAL	COLOR
110714	CG-42	13-1/2" x 17-9/16" x 42"	Steel	Yellow

Vestil™ Pipe & Downspout Protector

Install the Pipe & Downspout Protector to protect down spouts and pipes from damage by fork trucks and vehicles. The protector fits around standard downspouts and installs easily without the need for extra personnel. Steel construction provides optimum strength; baked-in yellow powder coating provides toughness and high visibility.



C&M PART #	MFG PART #	USABLE DIMENSIONS (L x D x W)	MATERIAL	COLOR
110764	DSG-48	48" x 6" x 6"	Steel	Yellow

Vestil™ Machinery Guards



Use these high-profile, heavy-duty welded steel Machinery Guards to protect racks, building walls and expensive equipment. Yellow powder-coat finish provides high visibility and lasting durable coverage. Unit includes a mid-rail to comply with OSHA requirements. Four predrilled mounting holes in each base plate allow quick installation.

C&M PART #	MFG PART #	DIMENSIONS (L x H x Dia)	MATERIAL	COLOR
110909	HPRO-36-42-4	36-5/8" x 42-9/16" x 4-1/2"	Steel	Yellow
110910	HPRO-48-24-4	48-5/8" x 24-9/16" x 4-1/2"	Steel	Yellow
110911	HPRO-48-42-4	42-9/16" x 48-5/8" x 4-1/2"	Steel	Yellow

Vestil™ Safety Railings

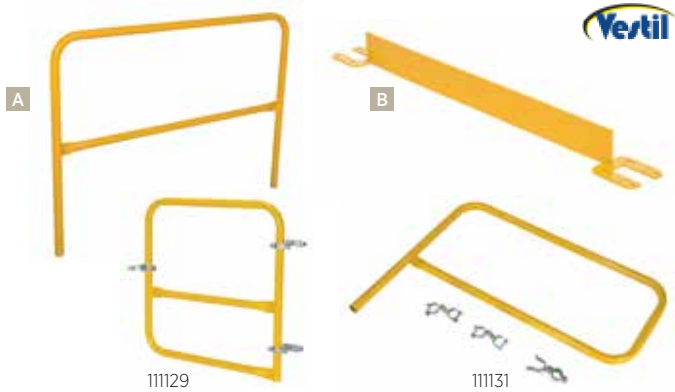

These Safety Railings create a secure and protective barrier, often used in construction sites, industrial settings, or even for residential applications. These kits typically include posts, rails, connectors, and other necessary accessories to assemble a sturdy and compliant safety railing system.

The Pipe Safety Railings provide a great addition to pathways and dock areas. The yellow-colored finish allows for visibility of the handrail to create a more secure environment. With a variety of mounting options, the unit can be permanently installed or removed after every use. When in place, the handrail creates an ergonomic position while gaining personal stability. The Toe Boards protect people from uneven walkways and mezzanine drop offs. Powder-coat safety yellow finish provides durability. Safety Railing Gates work great as an addition to the pipe safety railing.

SPECIFICATIONS

TOP RAIL HEIGHT	42"
MID RAIL HEIGHT	21"
HANDRAIL DIAMETER	1-5/8"
COLOR	Safety Yellow

CERTIFICATIONS

- 29 CFR 1910.29

C&M PART #	MFG PART #	LENGTH
A STEEL PIPE SAFETY RAILINGS		
111105	VDKR-2	24"
111106	VDKR-3	36"
111111	VDKR-4	48"
111107	VDKR-5	60"
111108	VDKR-6	72"
111109	VDKR-7	84"
111110	VDKR-8	96"
111112	VDKR-10	120"

C&M PART #	MFG PART #	LENGTH
B STEEL TOE BOARDS		
111113	VDKR-2-TB	24"
111114	VDKR-3-TB	36"
111115	VDKR-4-TB	48"
111116	VDKR-5-TB	60"
111117	VDKR-6-TB	72"
111118	VDKR-7-TB	84"
111119	VDKR-8-TB	96"
111120	VDKR-10-TB	120"

C&M PART #	MFG PART #	LENGTH	WIDTH	SHAPE	COLOR
STEEL SAFETY RAILING GATES					
111129	VDKR-G3-B	36"	36"	B-Shaped	Black
111130	VDKR-G3	36"	36"	P-Shaped	Yellow
111131	VDKR-G4	48"	36"	P-Shaped	Yellow

REPLACEMENT PARTS & ACCESSORIES

C&M PART #	MFG PART #	DESCRIPTION	MATERIAL
111121	VDKR-W-101	Single Socket Without Toe Board for VDKR Models	Galvanized Steel
111122	VDKR-W-102	Double Socket Without Toe Board for VDKR Models	Galvanized Steel
111123	VDKR-P101	Single Socket for Pipe Safety Railing	Cast Steel
111124	VDKR-P102	Double Socket for Pipe Safety Railing	Cast Steel
111125	VDKR-P107	Sleeve for Pipe Safety Railing, 2" Diameter	Steel
111126	VDKR-BASE	Pipe Safety Railing Base	Cast Iron
111127	VDKR-BASE-W	Pipe Safety Railing Welded Base 24" x 24"	Steel
111128	VDKR-VM2	Wall Mount Bracket for Pipe Safety Railing	—
111132	AS-383	Concrete Sleeve Anchor Bolts, 3/8" x 3", 1 Each	Steel
111133	AS-383-4PK	Concrete Sleeve Anchor Bolts, 3/8" x 3", 4/Pack	Steel
111134	VDKR-CON	Hinged Connectors for Pipe Safety Railing	Steel

**KEEP SURFACES
ICE-FREE**

Visit our website at supply.coreandmain.com for our Ice Melt selection, including Scotwood Road Runner calcium chloride ice melt blend.



Vestil™ Rack Guards



Upright Rack Guard protects the foot of the racking system against damage from fork trucks and other vehicles. The guard simply slides in at the foot of the racking system and protects the front as well as the sides. Strong steel construction offers excellent protection; colored yellow for clear visibility.

Low-Profile Rack Guards protect pallet racking and wall corners against damage from fork trucks, pallet trucks, and carts. Quick and easy two hole installation—installs in half the time of other guards. Mounting kit sold separately.

Corner Guard help protect busy corners, expensive machinery and personnel. Place this non-permanent guard that provides a 90-degree perpendicular protection wherever you need it. Heavy-gauge steel construction offers durability and strength. The highly visible “SAFETY-FIRST” sticker helps remind personnel of the number one priority—Safety.

C&M PART #	MFG PART #	TYPE	DIMENSIONS (L x W x H)	MATERIAL	COLOR
110819	G3-V4-YL	Upright Rack Guard	7" x 5" x 5"	Steel	Yellow
110957	NPG4-12	Low-Profile Rack Guard	3v x 8v x 11-7/8v	Steel	Yellow
110958	NPG4-18	Low-Profile Rack Guard	3" x 8" x 17-7/8"	Steel	Yellow
110959	NPG4-24	Low-Profile Rack Guard	3" x 8" x 23-7/8"	Steel	Yellow
110960	NPG4-36	Low-Profile Rack Guard	3" x 8" x 35-7/8"	Steel	Yellow
110961	NPG6-12	Low-Profile Rack Guard	3" x 10" x 11-7/8"	Steel	Yellow
110962	NPG6-18	Low-Profile Rack Guard	3" x 10" x 17-7/8"	Steel	Yellow
110963	NPG6-24	Low-Profile Rack Guard	3" x 10" x 23-7/8"	Steel	Yellow
110964	NPG6-36	Low-Profile Rack Guard	3" x 10" x 35-7/8"	Steel	Yellow
110972	PCG-16	Corner Guard	16" x 16" x 16"	Steel	Yellow

REPLACEMENT PARTS & ACCESSORIES

C&M PART #	MFG PART #	DESCRIPTION	DIMENSIONS	QTY
110965	AS-125	Replacement Steel Concrete Sleeve Anchor Bolt	1/2" x 5"	1
110966	AS-125-4PK	Mounting Kit with Steel Concrete Sleeve Anchor Bolts	1/2" x 5"	4

Vestil™ HDPE IBC Containers



High-Density Polyethylene Intermediate Bulk Containers (IBC) are designed for storage of hazardous and nonhazardous materials. These IBCs are easy to fill, stack and load and help save space in facilities. The hot dipped galvanized steel cage is consistent with Food Code requirements for use in nondirect food contact environments. The pallet base is made from both steel and plastic while inner storage tank is made from white plastic with a UV-blocking additive. Spigot includes 2" NPT threaded butterfly valve with a durable, synthetic fluorocarbon rubber gasket.



Note: Not to be used with flammable materials, such as gasoline.

CERTIFICATIONS

- Complete unit is UN 31HA1/Y approved, both units are DOT certified

C&M PART #	MFG PART #	UNIFORM CAPACITY (lbs)	UNIFORM VOLUME CAPACITY (GAL)	MAXIMUM LIQUID TEMPERATURE (°F)	WEIGHT (lbs)
110923	IBC-275	2500	275	190	130
110924	IBC-330	3000	330	190	140

Vestil™ Steel Concrete Sleeve Anchor Bolts



Commonly used in construction and structural applications, these Steel Concrete Sleeve Anchor Bolts provide a strong and reliable connection between the object being anchored and the concrete. Zinc plated steel construction ensures resilience and long lasting even through the harshest environment.

FEATURES & BENEFITS

- Anchor design makes installation quicker and easier
- Zinc plated steel provides a strong anchor point
- Sleeve length provides added security

C&M PART #	MFG PART #	DIAMETER	LENGTH	QUANTITY
111132	AS-383	3/8"	3"	Each
111133	AS-383-4PK	3/8"	3"	4/Pack
110965	AS-125	1/2"	5"	Each
110966	AS-125-4PK	1/2"	5"	4/Pack
110684	AS-344	3/4"	4"	Each
110685	AS-344-4PK	3/4"	4"	4/Pack



UltraTech Low-Profile Ultra-Spill Deck® Pallets

Use these Low-Profile Ultra-Spill Deck Pallets to easily move drums on and off the spill pallets. Bulkhead fittings “lock” the modules together as well as allow spilled liquid to flow from one module to the next. Low-profile pallets keep the top of the drums at a lower level, minimizing potential risk of splashes or spilled liquid right at eye level. Order optional loading ramp for added drum handling safety and convenience (not for use with one-drum model or short side of two-drum model).



C&M PART #	MFG PART #	DRUM QUANTITY	DIMENSIONS (L x W x H)	GRATING SURFACE	WEIGHT CAPACITY UDL (lbs)	CONTAINMENT CAPACITY (GAL)	WEIGHT (lbs)
10924903	1321	1	25.9" x 25.9" x 5.8"	24" x 24"	1500	11	23
10924904	1086	2	52" x 25.9" x 5.8"	48" x 24"	3000	22	40
10924906	1072	4	52" x 52" x 5.8"	48" x 48"	6000	44	70

FEATURES & BENEFITS

- All-polyethylene constructions meets a wide range of chemical compatibility needs
- Applications include hazardous waste collection, storage of virgin chemicals, drum dispensing and battery storage
- 5-year warranty

REPLACEMENT PARTS & ACCESSORIES

C&M PART #	MFG PART #	DESCRIPTION	DIMENSIONS (L x W x H)	WEIGHT CAPACITY UDL (lbs)	WEIGHT (lbs)
109258	1089	Loading Ramp	32" x 24" x 5.8"	600	17

UltraTech Ultra-Spill Deck® Bladder System

The Ultra-Spill Deck Bladder System offers a lowest profile spill containment deck to capture large spills or drum leaks without the need to connect more spill decks. This uniquely designed spill system features a rolled up 66-gallon hidden containment bladder that automatically unfurls to capture large spills or drum leaks. The sump catches overspills and small leaks while the bladder, once deployed captures catastrophic leaks. Add the bladder attachment to your standard P1, P2 or P4 spill decks to expand its capacity by 66 gallons. By adding the bladder system to any spill deck, it meets EPA and SPCC Spill Containment Regulations without expanding its footprint.

Available in 1, 2 and 4 drum-modules, the low 5-3/4" deck height allows safe and convenient drum loading, even without drum handling equipment. Add the optional polyethylene (LLDPE) loading ramp for even greater handling ease.



C&M PART #	MFG PART #	DRUM QUANTITY	DIMENSIONS (L x w x H)	GRATING SURFACE	WEIGHT CAPACITY UDL (lbs)	CONTAINMENT CAPACITY (GAL)	WEIGHT (lbs)
10925203	1320	1	30.5" x 25.9" x 5.8"	24" x 24"	1500	77	27
10925204	2329	2	52" x 30.5" x 5.8"	48" x 24"	3000	88	44
10925206	2330	4	56.6" x 52" x 5.8"	48" x 48"	6000	110	66

REPLACEMENT PARTS & ACCESSORIES

C&M PART #	MFG PART #	DESCRIPTION	DIMENSIONS (L x W x H)	WEIGHT CAPACITY UDL (lbs)	CONTAINMENT CAPACITY (GAL)	WEIGHT (lbs)
109255	2317	Bladder Attachment	25.9" x 4.6" x 4.6"	-	66	4
109256	6340	Replacement Bladder	66" x 65.5" x 4.5"	-	66	2
109257	2345	Bladder Pump	12" x 7" x 5.5"	-	-	3
109258	1089	Loading Ramp	32" x 24" x 5.8"	600	-	17

UltraTech 550 Containment Sumps®



Use Containment Sumps to eliminate costly spills while storing fuels, oils and other hazardous liquids. These rugged, all polyethylene construction containment sumps will not rust or corrode. Easily transport to where you need it—simply place it on a wooden shipping pallet to move. Order optional Ultra-Self Bailer to use with Containment Sump with drain (10927601) that allows clean stormwater to passively drain from sump while capturing hydrocarbons.

FEATURES & BENEFITS

- Meets Stormwater, SPCC and EPA Container Storage Regulation 40 CFR 264.175 and helps meet Stormwater Management Regulations NPDES, 40 CFR 122.26 (1999)
- Protected by an industry leading five (5) year warranty against any material or workmanship defects

C&M PART #	MFG PART #	DRAIN (Y/N)	DIMENSIONS (L x H x W)	CONTAINMENT CAPACITY (GAL)	WEIGHT (lbs)
10927601	2820	Y	90" x 61" x 32.8"	605	108
10927602	2823	N	90" x 61" x 32.8"	605	108

ULTRA-SELF BAILERS

C&M PART #	MFG PART #	MODEL	CAPACITY (fl oz)	FLOW RATE (GPH)	WEIGHT (lbs)
10928823	9935	Standard	14	4.8	2
109288LG	9937	Large	27	6.6	6
109288XL	9926	Extra Large	100	12.7	11

UltraTech Ultra-Self Bailer®



Rain can create a problem for outdoor spill containment unless it is covered/protected from the elements. If the sump of the containment unit fills up with rainwater, it loses its capacity to contain chemical/fuel/hazmat spills. Connect a Ultra-Self Bailer to any spill containment unit to drain the rainwater—great for nonmonitored containment sites. Any residual oil, gas or other hydrocarbons is removed by the filter media inside of the unit, allowing only clean water to exit. In the event of a spill, the media swells, completely sealing off the self bailer preventing any liquid from escaping.

FEATURES & BENEFITS

- Simple installation—connect to almost any UltraTech containment product using a bulkhead fitting
- Hydrocarbon “sheens” and modest spills are captured—clean stormwater drains through the outflow port
- Larger or concentrated spills activate “auto shut-off” mechanism
- Manual shut-off valve can be used to secure all draining operations and change out the filter cartridge
- Filters are quickly and easily replaced
- PVC construction - will not rust or corrode

C&M PART #	MFG PART #	MODEL	DIMENSIONS (L x W x H)	WEIGHT (lbs)	CAPACITY (fl oz)	FLOW RATE (GAL/HR)
10928823	9935	Standard	28" x 3.5" x 3.5"	2.5	14	4.8
109288LG	9937	Large	36" x 4.5" x 4.5"	6	27	6.6
109288XL	9926	Extra Large	39" x 6.5" x 6.5"	11	100	12.7

UltraTech Ultra-Utility Trays®



Use these heavy-duty polyethylene (LLDPE) Ultra-Utility Trays to catch spilled or leaked liquids. A ribbed platform on the bottom of the tray keeps cans, pails and other containers out of smaller spills. Ideal for storing oil cans or other liquid holding containers, leaky machine parts or equipment. Place under trucks or other large vehicles to capture leaks and spills from engines, hydraulics or other lubricated parts.

FEATURES & BENEFITS

- LLDPE construction will not rust or corrode
- Nestable design for easy storage when not in use

C&M PART #	MFG PART #	OUTSIDE DIMENSIONS (L x W x H)	INSIDE DIMENSIONS (L x W x H)	CONTAINMENT CAPACITY (GAL)	WEIGHT (lbs)
10928234	1031	52.3" x 16.3" x 5"	48" x 12" x 4.75"	12	8
10928238	1034	40.3" x 28.3" x 5"	36" x 24" x 4.75"	18	9
10928236	1032	52.3" x 28.3" x 5"	48" x 24" x 4.75"	24	12
10928239	1035	40" x 40" x 5"	36" x 36" x 5"	27	11
10928237	1033	52.3" x 34.3" x 5"	48" x 30" x 4.75"	30	13
10928240	1036	52" x 44" x 4"	48" x 40" x 3.5"	30	19

Vestil™ Cantilever Carts

Store bar stock type items on the Portable Cantilever Carts. The cart includes three pairs of arms, secured to the cart with a bolt and nut. Adjust the arm height in 6" increments and mount at an incline or parallel to the ground. Use the four casters for easy transportation; built in fork pockets allow transport by fork trucks. All steel construction with blue powder-coat finish provides durability.



C&M PART #	MFG PART #	CAPACITY (lbs)	L x W x H
110696	CANT-3048	2000	48" x 30" x 64-11/16"
110697	CANT-3060	2000	60" x 30" x 64-11/16"
110698	CANT-3648	2000	48" x 36" x 64-11/16"

Vestil™ Material Racking

This Floor-Mounted Material Rack features three storage bays and holds various tall items. Bright zinc plating provides long term attractive appearance. Includes assembly hardware. (Concrete mounting hardware is not included.)



C&M PART #	MFG PART #	DIMENSIONS (L x W x H)	CAPACITY (lbs)	WEIGHT (lbs)
111049	SR-V	24" x 36" x 72"	2000	55

Vestil™ Pallet Rack Netting

Nylon Pallet Rack Netting helps minimize the potential of racked products falling off the back of pallet racks. The nylon mesh rope is 3/16" thick; netting has 4" x 4" holes. The nylon mesh is edged with polypropylene rope for durability. Black nylon zip ties are included for attaching netting to pallet racking and connecting nettings together. This netting is designed for flush mounting on pallet racking.



Vestil™ Sheet Racks



A Horizontal Sheet Rack stores sheet goods and similar materials horizontally to reduce warping of thin materials. Shelf design allows for generous storage of multiple thickness materials. Four sided access when using 4 ft x 8 ft sheet or smaller. Supplied with lag down points. Steel construction offers highly efficient and durable use.

B Variable Height Sheet Rack stores various sizes of sheet goods in the vertical position for easy viewing of stock. The bays are of different heights to increase visibility of stored materials—perfect for use with multiple sizes of material. Welded steel construction provides durability. Unit is supplied with lag down points.

C Standard Sheet Rack is constructed for the upright placement of goods. The rack has four bays for the location of products. Install vertically or horizontally depending on your storage needs. Intermediate floor bracing provides added support while keeping material off the floor. The unit comes standard with lag down points.

C&M PART #	MFG PART #	DESCRIPTION	DIMENSIONS (L x W x H)	CAPACITY (lbs)	WEIGHT (lbs)
111039	SHEET-R-57	Horizontal	102-3/4" x 54-1/2" x 48"	2000	443
111147	VHSR-4	Variable Height	47-3/8" x 36" x 41-3/4"	1500	140
111148	VSSR-15	Standard	50" x 84" x 44"	1500	266

C&M PART #	MFG PART #	L x W	CAPACITY (lbs)	QTY
111005	PRN-99-4	99" x 48"	2500	1
111006	PRN-99-8	99" x 96"	2500	2
111004	PRN-111-4	111" x 48"	2500	1
111007	PRN-111-8	111" x 96"	2500	2
111008	PRN-123-4	123" x 48"	2500	1
111009	PRN-123-8	123" x 96"	2500	2

Vestil™ Vertical Bar Racks

These Vertical Storage Racks provide a perfect storage area for long and tall items such as studs, tubing and piping. They are designed to be placed up against a wall, helping you keep your work area organized. Steel construction provides durability. A secure fastener can keep items in the storage bay.



C&M PART #	MFG PART #	DIMENSIONS (L x W x H)	NUMBER OF BAYS	CAPACITY (lbs)	WEIGHT (lbs)
111054	SSRT-47	24" x 48-1/2" x 60-7/8"	4	1500	153
110772	EVR-106-S	23" x 53" x 106-17/32"	4	4000	198
110773	EVR-59-S	21-3/4" x 53" x 59-17/32"	4	4000	129
111103	VBR-9	24" x 39-1/4" x 84-1/2"	3	3000	110

Dri-Eaz® Rover HVE Extractor

Maximize water extraction efficiency on all types of carpet with the Rover HVE Extractor. Operated by a joystick control, the ride-on Rover maneuvers easily, reduces operator fatigue and significantly boosts extraction consistency and thoroughness. Separate drive wheels allow the Rover HVE to move easily around corners and into and out of tight spots. Unit folds flat for easy wheeled transport.



FEATURES & BENEFITS

- Two-speed control lets you optimize extraction effectiveness
- Replaceable polymer glide seals firmly over all carpets to provide deep extraction
- Joystick is rated for 5 million cycles
- Extraction can be visually monitored through the clear take-up tube

SPECIFICATIONS

EXTRACTION PATH WIDTH	19.75"
POWER	110 W (One 0.148 HP motor on each wheel)
CORD LENGTH (ft)	45
HOUSING	Rotomolded Polyethylene
FRAME	Stainless Steel
DIMENSIONS (W x H x D)	22" x 45.7" x 27.6" (Open); 22" x 40.5" x 10.7" (Folded)
WEIGHT (lbs)	67

CERTIFICATIONS

- ETL listed to UL/cUL and CSA standards

C&M PART #	MFG PART #	DESCRIPTION
401243	112125	Rover HVE Extractor

Dri-Eaz® HVE 3000 Flood Pumper



The HVE 3000 Flood Pumper boasts high vacuum and powerful lift to quickly pull maximum amount of water from carpet and pad. A clog-resistant, high-volume industrial pump delivers up to 50 gpm and handles up to 1/2" inch solids. The 12-gallon tank holds the collected water reducing frequent trips to the drains. Quickly empty the tank by auto pumpout using a barbed outlet and a 1-1/2" drain hose or a 3/4" converter outlet fitting and a standard garden hose. A narrow profile and large rear wheels make it easy to transport the unit. Use with a truckmount to boost vacuum or intercept extracted water to keep truckmount tank from filling up. Operator can also use the HVE 3000 to bypass the truckmount waste tank for black water flood extraction to keep the tank clean.

FEATURES & BENEFITS

- Clear-view first-stage filter lifts out for easy rinsing
- Dual vacuum blowers with 2" inlet ensures maximum airflow
- Exhaust air passes through a HEPA filter which helps prevent the spread of contaminants and odors

INCLUDES

- 25 feet of 2" vacuum hose with cuffs.

SPECIFICATIONS

PUMPOUT DISCHARGE RATES (GPM)	1.5" outlet: 50 3/4" outlet: 12
POWER	115 VAC
TANK CAPACITY (GAL)	12
STATIC PRESSURE (BLOWER 1)	8" Hg; 108" H ₂ O
STATIC PRESSURE (BLOWER 2)	10" Hg; 136" H ₂ O
STATIC PRESSURE (BOTH BLOWERS)	12" Hg; 164" H ₂ O
DIMENSIONS (W x H x D)	22.5" x 40.2" x 23.6"
WEIGHT (lbs)	132

CERTIFICATIONS

- ETL listed to UL/cUL and CSA standards

C&M PART #	MFG PART #	DESCRIPTION
401244	107977	HVE 3000 Flood Pumper

REPLACEMENT PARTS & ACCESSORIES

C&M PART #	MFG PART #	DESCRIPTION
401246	104221	HVE Flood Extraction Tool
401245	105626	HEPA Filter for HVE 3000, 4/Pack



Check Out Our **Safety** Section for First Aid Kits and Supplies

Find the First Aid product that fits your needs with our large selection of A, A+, B and B+ First Aid Kits and Cabinets on **page 333**.

Don't let your workers get caught in an emergency without the right first aid supplies, stock up today!



Check Out Our **Signs, Tags & Labels** Section to Keep Your Facility Safe and Organized



Mark directional flow of pipe contents throughout your facility with Color-Coded Arrow Tapes. Repeated arrows on the entire length of the tape provide 360-degree visibility for flow direction.

See our assortment of color-coded arrow tapes on page 388.



ACCUFORM **NMC**
Accurate Safety Group

Improve organization at your facility with Floor Marking Tapes, ideal for marking aisles, pathways, work areas, hazard areas, storage locations and outlining machinery.

See our full assortment of floor marking tapes on page 389.



Ensure the safety of visitors and employees by marking possible hazards with Safety Marking Tapes. The 6-mil thick vinyl tapes apply easily to clean, smooth and dry surfaces with a synthetic rubber resin adhesive.

See our assortment of safety marking tapes on pages 390-391.



Keep everyone in your facility well informed about the contents of pipes with Pipe Markers. Pipe markers effectively provide details of the flow direction and hazard classification of pipe contents, preventing incidents and improving safety.

See our assortment of pipe markers on pages 392-395.

Filtration



TABLE OF CONTENTS

Bag Filters	174
Bag Filter Housings	175
Sediment Cartridges	176-179
Carbon Cartridges	180
High Flow Filter Cartridges	180-181
Plastic Filter Housings	182
Stainless Steel Filter Housings	183
High Flow Filter Housings	184-186

Core & Main Reusable Polypropylene Bag Filters



Bag filters are used to remove particulate matter and dust from industrial gases. It is commonly employed in various industries, including water & wastewater treatment plants as a type of air pollution control device. The primary function of a bag filter is to capture and filter out solid particles from a gas stream before they are released into the atmosphere.

FEATURES & BENEFITS

- Designed to fit most manufacturers housings
- Micron ratings from 1 to 200
- Superb solids-loading capacity
- High particle retention

CERTIFICATIONS

- All materials comply with FDA requirements for Food & Beverage contact per CFR Title 21 174.5, 177.1520 and 177.1630; All components meet USP Class VI Plastics

SPECIFICATIONS

FILTER MEDIA	Polypropylene
RING	Polypropylene
HANDLE	Polypropylene
OPERATING TEMPERATURE	195°F @ 20 psi (90°C @ 2.4 bar)
FLOW RATE	Bag 1 Series: 20 m ³ /hr. (88 gal/min) Bag 2 Series: 40 m ³ /hr. (176 gal/min) Bag 3 Series: 6 m ³ /hr. (26.4 gal/min) Bag 4 Series: 12 m ³ /hr. (52.8 gal/min)
RECOMMENDED CHANGEOUT	Differential Pressure: 35 psid (2.4 bar)

CHEMICAL COMPATIBILITY

CHEMICAL	RATING
Water/Potable Liquids	Excellent
Alkalis	Excellent
Organic Solvents	Good
Oils	Fair
Oxidizing Acids	Poor
Dilute Inorganic Acids	Excellent
Strong Inorganic Acids	Excellent

C&M PART #	MFG PART #	NOMINAL MICRON RATING (μ)	LENGTH x DIAMETER
BAG 1 SERIES			
4019308730	BAG1-1M	1	17" x 7"
4019308787	BAG1-3M	3	17" x 7"
40193087F9	BAG1-5M	5	17" x 7"
40193087N8	BAG1-10M	10	17" x 7"
40193087X2	BAG1-25M	25	17" x 7"
40193087BC	BAG1-50M	50	17" x 7"
40193087CG	BAG1-75M	75	17" x 7"
40193087DG	BAG1-100M	100	17" x 7"
40193087ED	BAG1-150M	150	17" x 7"
40193087EM	BAG1-200M	200	17" x 7"
BAG 2 SERIES			
4019308830	BAG2-1M	1	32" x 7"
4019308887	BAG2-3M	3	32" x 7"
40193088F9	BAG2-5M	5	32" x 7"
40193088N8	BAG2-10M	10	32" x 7"
40193088X2	BAG2-25M	25	32" x 7"
40193088BC	BAG2-50M	50	32" x 7"
40193088CG	BAG2-75M	75	32" x 7"
40193088DG	BAG2-100M	100	32" x 7"
40193088ED	BAG2-150M	150	32" x 7"
40193088EM	BAG2-200M	200	32" x 7"
BAG 3 SERIES			
4019308930	BAG3-1M	1	8" x 4"
4019308987	BAG3-3M	3	8" x 4"
40193089F9	BAG3-5M	5	8" x 4"
40193089N8	BAG3-10M	10	8" x 4"
40193089X2	BAG3-25M	25	8" x 4"
40193089BC	BAG3-50M	50	8" x 4"
40193089CG	BAG3-75M	75	8" x 4"
40193089DG	BAG3-100M	100	8" x 4"
40193089ED	BAG3-150M	150	8" x 4"
40193089EM	BAG3-200M	200	8" x 4"
BAG 4 SERIES			
4019309030	BAG4-1M	1	14" x 4"
4019309087	BAG4-3M	3	14" x 4"
40193090F9	BAG4-5M	5	14" x 4"
40193090N8	BAG4-10M	10	14" x 4"
40193090X2	BAG4-25M	25	14" x 4"
40193090BC	BAG4-50M	50	14" x 4"
40193090CG	BAG4-75M	75	14" x 4"
40193090DG	BAG4-100M	100	14" x 4"
40193090ED	BAG4-150M	150	14" x 4"
40193090EM	BAG4-200M	200	14" x 4"

HydroScientific™ BF/MBF Series Bag Filter Housings

These BF/MBF Series Bag Filter Housings are ideal for most commercial, municipal and industrial applications. They are made with high-grade stainless steel and easily accept most standard filter bags. Single-bag housings come with adjustable legs.

FEATURES & BENEFITS

- Band clamp or swing bolt design
- 304 or 316 stainless steel housing
- Positive O-ring seal
- Single and multiple bag filter options
- Electropolished and bead blasted finish
- Clean and dirty drains
- Clean and dirty gauge ports

CERTIFICATIONS

- NSF/ANSI/CAN61 and NSF/ANSI 372 certified



HydroScientific



Band Clamp Lid Closure

SPECIFICATIONS

HOUSING SHELL	304 or 316 Stainless Steel
BAND CLAMP LID CLOSURE	304 or 316 Stainless Steel
SWING BOLT LID CLOSURE	Zinc Plated Steel
VENT AND DRAIN PLUGS	304 or 316 Stainless Steel
HEAVY-DUTY MOUNTING LEGS	304 or 316 Stainless Steel
O-RING/GASKET	EPDM – FDA Grade (Viton®, Silicone, and ERP Options)
MAX. PRESSURE RATING (BAND CLAMP)	150 psi @ 250°F (10.3 bar at 121°C)
MAX. PRESSURE RATING (SWING BOLT)	150 psi @ 300°F (10.3 bar at 149°C)
GAUGE PORTS	Single Bag 1/4" FNPT Multi-Bag 1/2" FNPT

C&M PART #	MFG PART #	CONFIGURATION	MATERIAL	PORTS	MAX FLOW (GPM)
BF SERIES—304 SS & 316 SS BAND CLAMP SINGLE-BAG (#1, #2, #3 AND #4) HOUSINGS					
40193791037C	BF1-304-2NBC	1 x Size #1 Filter	304 SS	2" FNPT	90
40193792037C	BF2-304-2NBC	1 x Size #2 Filter	304 SS	2" FNPT	200
40193793037D	BF3-304-1NBC	1 x Size #3 Filter	304 SS	1" FNPT	20
40193794037D	BF4-304-1NBC	1 x Size #4 Filter	304 SS	1" FNPT	45
40193791047C	BF1-316-2NBC	1 x Size #1 Filter	316 SS	2" FNPT	90
40193792047C	BF2-316-2NBC	1 x Size #2 Filter	316 SS	2" FNPT	200
40193793047D	BF3-316-1NBC	1 x Size #3 Filter	316 SS	1" FNPT	20
40193794047D	BF4-316-1NBC	1 x Size #4 Filter	316 SS	1" FNPT	45
BF SERIES—304 SS & 316 SS SWING BOLT SINGLE-BAG (#1 AND #2) HOUSINGS					
40193891037C	BF1-304-2N	1 x Size #1 Filter	304 SS	2" FNPT	90
40193892037C	BF2-304-2N	1 x Size #2 Filter	304 SS	2" FNPT	200
40193891047C	BF1-316-2N	1 x Size #1 Filter	316 SS	2" FNPT	90
40193892047C	BF2-316-2N	1 x Size #2 Filter	316 SS	2" FNPT	200
MBF SERIES—304 SS SWING BOLT MULTIBAG (#1 AND #2) HOUSINGS					
40193895037E	MBF2-304-3F	2 x Size #2 Filter	304 SS	3" Flange	396
40193896037F	MBF3-304-4F	3 x Size #2 Filter	304 SS	4" Flange	594
40193897037F	MBF4-304-4F	4 x Size #2 Filter	304 SS	4" Flange	793
40193898037G	MBF5-304-6F	5 x Size #2 Filter	304 SS	6" Flange	991
40193899037G	MBF6-304-6F	6 x Size #2 Filter	304 SS	6" Flange	1189
4019380A037H	MBF8-304-8F	8 x Size #2 Filter	304 SS	8" Flange	1585
4019380B037I	MBF12-304-10F	12 x Size #2 Filter	304 SS	12" Flange	2378
MBF SERIES—316 SS SWING BOLT MULTIBAG (#1 AND #2) HOUSINGS					
40193895047E	MBF2-316-3F	2 x Size #2 Filter	316 SS	3" Flange	396
40193896047F	MBF3-316-4F	3 x Size #2 Filter	316 SS	4" Flange	594
40193897047F	MBF4-316-4F	4 x Size #2 Filter	316 SS	4" Flange	793
40193898047G	MBF5-316-6F	5 x Size #2 Filter	316 SS	6" Flange	991
40193899047G	MBF6-316-6F	6 x Size #2 Filter	316 SS	6" Flange	1189
4019380A047H	MBF8-316-8F	8 x Size #2 Filter	316 SS	8" Flange	1585
4019380B047J	MBF12-316-10F	12 x Size #2 Filter	316 SS	10" Flange	2378

GET THE RIGHT FILTER

See **page 186** for a table showing compatible filters and filter housings and a measurement guide for individual filters.



Core & Main NSF Sediment Depth Cartridge Filters



These Sediment Depth Cartridges (SDC) are an economical solution to pre- or post-filtration for many applications. Featuring true multistage depth filtration, these filters trap various sized particles layer by layer and provide a much higher dirt holding capacity than standard spun polypropylene and string-wound cartridges. The cartridges feature four separate layers of micron filtration with the outer layer capturing the larger sized particles, resulting in a much lower pressure drop compared to conventional filters.

Use the SDC cartridges as pre-filtration for RO systems, post-filtration for GAC filters, ice machines, film processing, beverage, coffee, analytical, wineries and many others.

FEATURES & BENEFITS

- 100% high-purity polypropylene—surfactant free, binder free and adhesive free
- Four layers, outside-in flow and step-by-step micron rating effectively retains particles and extends filter life
- High chemical resistance

CERTIFICATIONS

- NSF Standard 42, 61 & 372 certified

SPECIFICATIONS

FILTER MEDIA	100% Polypropylene
TEMPERATURE RANGE	40°F to 145°F (4.4°C to 79.4°C)
MAX. OPERATING TEMPERATURE	145°F (63°C)
MAX. PRESSURE DROP	69°F (20°C) at 46.4 psi (3.2 kg/cm ²)
MAX. FLOW RATE	2 to 8 GPM (Depending on Micron Rating)
RECOMMENDED CHANGEOUT	Differential Pressure: 21.75 psi (1.5 kg/cm ²)
MAX. DIFFERENTIAL PRESSURE	15 psid at 175°F (1.0 bar at 80°C) 25 psid at 140°F (1.7 bar at 60°C) 60 psid at 68°F (4.13 bar at 20°C)

C&M PART #	MFG PART #	NOMINAL MICRON RATING (μ)	LENGTH x DIAMETER
SDC FLEX SERIES—2.5" SEDIMENT DEPTH CARTRIDGES			
401971F6300H	SDC-25-0501	1	4-7/8" x 2.5"
401971F6F90H	SDC-25-0505	5	4-7/8" x 2.5"
401971F6N80H	SDC-25-0510	10	4-7/8" x 2.5"
4019715J0EOH	SDC-25-10-0.5	0.5	9-7/8" x 2.5"
4019715J300H	SDC-25-1001	1	9-7/8" x 2.5"
4019715JF90H	SDC-25-1005	5	9-7/8" x 2.5"
4019715JN80H	SDC-25-1010	10	9-7/8" x 2.5"
4019715JV20H	SDC-25-1020	20	9-7/8" x 2.5"
4019715JZ10H	SDC-25-1030	30	9-7/8" x 2.5"
4019715JBCOH	SDC-25-1050	50	9-7/8" x 2.5"
401971V20EOH	SDC-25-20-0.5	0.5	20" x 2.5"
401971V2300H	SDC-25-2001	1	20" x 2.5"
401971V2F90H	SDC-25-2005	5	20" x 2.5"
401971V2N80H	SDC-25-2010	10	20" x 2.5"
401971V2V20H	SDC-25-2020	20	20" x 2.5"
401971V2BCOH	SDC-25-2050	50	20" x 2.5"
401971TG300H	SDC-25-29141	1	29-1/4" x 2.5"
401971TGF90H	SDC-25-29145	5	29-1/4" x 2.5"
401971Z1300H	SDC-25-3001	1	30" x 2.5"
401971Z1F90H	SDC-25-3005	5	30" x 2.5"
401971Z1N80H	SDC-25-3010	10	30" x 2.5"
401971Z1X20H	SDC-25-3025	25	30" x 2.5"
401971Z1CGOH	SDC-25-3075	75	30" x 2.5"
401971AL300H	SDC-25-4001	1	40" x 2.5"
401971AL0EOH	SDC-25-40-0.5	0.5	40" x 2.5"
401971ALF90H	SDC-25-4005	5	40" x 2.5"
401971ALN80H	SDC-25-4010	10	40" x 2.5"
401971ALX20H	SDC-25-4025	25	40" x 2.5"
401971ALBCOH	SDC-25-4050	50	40" x 2.5"
401971ALCGOH	SDC-25-4075	75	40" x 2.5"
401971BCF90H	SDC-25-5005	5	50" x 2.5"
SDC FLEX SERIES—4.5" SEDIMENT DEPTH CARTRIDGES			
4019715J300J	SDC-45-1001	1	9-7/8" x 4.5"
4019715JF90J	SDC-45-1005	5	9-7/8" x 4.5"
4019715JN80J	SDC-45-1010	10	9-7/8" x 4.5"
4019715JV20J	SDC-45-1020	20	9-7/8" x 4.5"
4019715JBCOJ	SDC-45-1050	50	9-7/8" x 4.5"
401971V2300J	SDC-45-2001	1	20" x 4.5"
401971V2F90J	SDC-45-2005	5	20" x 4.5"
401971V2N80J	SDC-45-2010	10	20" x 4.5"
401971V2V20J	SDC-45-2020	20	20" x 4.5"
401971V2BCOJ	SDC-45-2050	50	20" x 4.5"

Core & Main NSF Sediment Bonded Depth Cartridge Filter

Sediment Bonded Depth Cartridges (SBC) are specially designed thermally bonded polypropylene filters that provide superior filtration performance. SBC filters utilize a durable polypropylene center core for increased strength and structural integrity. The filters have fine grooves on the outside of the filter for increased surface area and will not impart color, taste, or odor on the liquid being filtered. SBC filters produce consistent flow rates and have no fiber release.



CERTIFICATIONS

- NSF Standard 42, 61, & 372 certified

SPECIFICATIONS

FILTER MEDIA	100% Polypropylene
TEMPERATURE RANGE	40°F to 145°F (4.4°C to 79.4°C)
MAX. OPERATING TEMPERATURE	145°F (63°C)
MAX. PRESSURE DROP	69°F (20°C) at 46.4 psi (3.2 kg/cm ²)
MAX. FLOW RATE	2 to 8 gpm (Depending on micron rating)
RECOMMENDED CHANGEOUT	Differential Pressure: 21.75 psi (1.5 kg/cm ²)
MAX. DIFFERENTIAL PRESSURE	15 psid at 175°F (1.0 bar at 80°C) 25 psid at 140°F (1.7 bar at 60°C) 60 psid at 68°F (4.13 bar at 20°C)

C&M PART #	MFG PART #	NOMINAL MICRON RATING (μ)	LENGTH x DIAMETER
4019405J30	SBC-25-1001	1	9-7/8" x 2.5"
4019405JF9	SBC-25-1005	5	9-7/8" x 2.5"
4019405JN8	SBC-25-1010	10	9-7/8" x 2.5"
4019405JV2	SBC-25-1020	20	9-7/8" x 2.5"
4019405JBC	SBC-25-1050	50	9-7/8" x 2.5"
4019405K30	SBC-25-1951	1	19-1/2" x 2.5"
4019405KF9	SBC-25-1955	5	19-1/2" x 2.5"
401940V230	SBC-25-2001	1	20" x 2.5"
401940V2F9	SBC-25-2005	5	20" x 2.5"
401940V2N8	SBC-25-2010	10	20" x 2.5"
401940V2V2	SBC-25-2020	20	20" x 2.5"
401940TG30	SBC-25-29141	1	29-1/4" x 2.5"
401940TGF9	SBC-25-29145	5	29-1/4" x 2.5"
401940Z130	SBC-25-3001	1	30" x 2.5"
401940Z1F9	SBC-25-3005	5	30" x 2.5"
401940Z1N8	SBC-25-3010	10	30" x 2.5"
401940Z1V2	SBC-25-3020	20	30" x 2.5"
4019405L30	SBC-25-3901	1	39" x 2.5"
4019405LF9	SBC-25-3905	5	39" x 2.5"
401940AL30	SBC-25-4001	1	40" x 2.5"
401940ALF9	SBC-25-4005	5	40" x 2.5"

Core & Main NSF Sediment Grooved Cartridge Filters

Sediment Grooved Cartridges (SGC) are a reliable and economical solution for pre-filtration in many applications. Typically utilized for pre-filtration in RO systems and post-filtration in GAC filters, SGC cartridges with their grooved design offer a larger filtration area for longer life and larger filtration capacity.



FEATURES & BENEFITS

- Pre-filter for DI and RO water filtration systems
- Pre-filtration for manufacturing and water recycling

CERTIFICATIONS

- NSF Standard 42, 61, & 372 certified; All materials comply with FDA requirements for Food & Beverage contact per CFR Title 21 174.5, 177.1520 and 177.1630; All components meet USP Class VI Plastics

C&M PART #	MFG PART #	NOMINAL MICRON RATING (μ)	LENGTH x DIAMETER
4019435J30	SGC-25-1001	1	9-7/8" x 2.5"
4019435JF9	SGC-25-1005	5	9-7/8" x 2.5"
401943V230	SGC-25-2001	1	20" x 2.5"
401943V2F9	SGC-25-2005	5	20" x 2.5"
401943Z130	SGC-25-3001	1	30" x 2.5"
401943Z1F9	SGC-25-3005	5	30" x 2.5"
401943AL30	SGC-25-4001	1	40" x 2.5"
401943ALF9	SGC-25-4005	5	40" x 2.5"

**WE'D LIKE YOUR
FEEDBACK**

on our catalog and website



Send us your thoughts at
support.supply@coreandmain.com



Core & Main NSF String Wound Cartridge Filters



This String Wound Cartridge (SWC) Filters are a cost-effective solution for the reduction of sand, silt, rust, dirt and scale particles. Made from 100% polypropylene cord, SWC filters are suitable for a various municipal, industrial and well water applications. Different wound patterns for different micron ratings ensure that you are getting the right product for the right application.

FEATURES & BENEFITS

- High dirt holding capacity
- Reduces sand, silt, rust and scale particles

CERTIFICATIONS

- NSF Standard 42, 61, & 372 certified; All materials comply with FDA requirements for Food & Beverage contact per CFR Title 21 174.5, 177.1520 and 177.1630; All components meet USP Class VI Plastics

SPECIFICATIONS

FILTER MEDIA	Polypropylene Fiber Cord
CORE	Polypropylene
TEMPERATURE RANGE	40 to 165°F (4.4 to 73.9°C)
RECOMMENDED CHANGEOUT	30 psi maximum: dirty 10 to 15 psi optimum: change out

C&M PART #	MFG PART #	NOMINAL MICRON RATING (μ)	LENGTH x DIAMETER
SWC SERIES—2.5" STRING WOUND CARTRIDGES			
401973N80EOH	SWC-25-10-0.5	0.5	10" x 2.5"
401973N830OH	SWC-25-1001	1	10" x 2.5"
401973N8F9OH	SWC-25-1005	5	10" x 2.5"
401973N8N8OH	SWC-25-1010	10	10" x 2.5"
401973N8V2OH	SWC-25-1020	20	10" x 2.5"
401973N8Z1OH	SWC-25-1030	30	10" x 2.5"
401973N8BCOH	SWC-25-1050	50	10" x 2.5"
401973N8DGOH	SWC-25-10100	100	10" x 2.5"
401973V2OEOH	SWC-25-20-0.5	0.5	20" x 2.5"
401973V230OH	SWC-25-2001	1	20" x 2.5"
401973V2F9OH	SWC-25-2005	5	20" x 2.5"
401973V2N8OH	SWC-25-2010	10	20" x 2.5"
401973V2V2OH	SWC-25-2020	20	20" x 2.5"
401973V2Z1OH	SWC-25-2030	30	20" x 2.5"
401973V2BCOH	SWC-25-2050	50	20" x 2.5"
401973V2DGOH	SWC-25-20100	100	20" x 2.5"
401973Z1OEOH	SWC-25-30-0.5	0.5	30" x 2.5"
401973Z130OH	SWC-25-3001	1	30" x 2.5"
401973Z1F9OH	SWC-25-3005	5	30" x 2.5"
401973Z1N8OH	SWC-25-3010	10	30" x 2.5"
401973Z1V2OH	SWC-25-3020	20	30" x 2.5"
401973Z1Z1OH	SWC-25-3030	30	30" x 2.5"
401973Z1BCOH	SWC-25-3050	50	30" x 2.5"
401973Z1DGOH	SWC-25-30100	100	30" x 2.5"
401973AL30OH	SWC-25-4001	1	40" x 2.5"
401973ALF9OH	SWC-25-4005	5	40" x 2.5"
401973ALN8OH	SWC-25-4010	10	40" x 2.5"
401973ALV2OH	SWC-25-4020	20	40" x 2.5"
401973ALZ1OH	SWC-25-4030	30	40" x 2.5"
401973ALBCOH	SWC-25-4050	50	40" x 2.5"
401973ALDGOH	SWC-25-40100	100	40" x 2.5"
401973BCF9OH	SWC-25-5005	5	50" x 2.5"
SWC SERIES—4.5" STRING WOUND CARTRIDGES			
401973N80EOJ	SWC-45-10-0.5	0.5	10" x 4.5"
401973N830OJ	SWC-45-1001	1	10" x 4.5"
401973N8F9OJ	SWC-45-1005	5	10" x 4.5"
401973N8N8OJ	SWC-45-1010	10	10" x 4.5"
401973N8V2OJ	SWC-45-1020	20	10" x 4.5"
401973N8Z1OJ	SWC-45-1030	30	10" x 4.5"
401973N8BCOJ	SWC-45-1050	50	10" x 4.5"
401973N8DGOJ	SWC-45-10100	100	10" x 4.5"
401973V2OEOJ	SWC-45-20-0.5	0.5	20" x 4.5"
401973V230OJ	SWC-45-2001	1	20" x 4.5"
401973V2F9OJ	SWC-45-2005	5	20" x 4.5"
401973V2N8OJ	SWC-45-2010	10	20" x 4.5"
401973V2V2OJ	SWC-45-2020	20	20" x 4.5"
401973V2Z1OJ	SWC-45-2030	30	20" x 4.5"
401973V2BCOJ	SWC-45-2050	50	20" x 4.5"
401973V2DGOJ	SWC-45-20100	100	20" x 4.5"

KEEP YOUR FILTERS FRESH

Know when to change your filters by monitoring with Core & Main gauges. See **pages 203-206** for options.

Core & Main NSF Polyester Pleated Filters



Durable Polyester Pleated Cartridges are durable, washable and reusable. The polyester media pleated around a polypropylene core provide added strength. The ends are immersed in a thermosetting vinyl plastisol which fuses the three components together forming a unified end cap and gasket. The pleated cartridges are bacteria and chemical resistant and provide great dirt holding capacity to extend the time between cartridge change outs.

FEATURES & BENEFITS

- Bacteria and chemical resistance
- Washable and reusable

CERTIFICATIONS

- NSF Standard 42, 61, & 372 certified

SPECIFICATIONS

FILTER MEDIA	100% Polypropylene
END CAPS	Vinyl Plastisol
CORE	Polypropylene
TEMPERATURE RANGE	40 to 125°F (4.4 to 51.7°C)
RECOMMENDED CHANGEOUT	Differential Pressure: 30 psid (2.07 bar)

C&M PART #	MFG PART #	NOMINAL MICRON RATING (μ)	LENGTH x DIAMETER
SPC SERIES—2.5" POLYESTER PLEATED CARTRIDGES			
401972N4300H	SPC-25-1001	1	9-3/4" x 2.5"
401972N4F90H	SPC-25-1005	5	9-3/4" x 2.5"
401972N4N80H	SPC-25-1010	10	9-3/4" x 2.5"
401972N4V20H	SPC-25-1020	20	9-3/4" x 2.5"
401972N4Z10H	SPC-25-1030	30	9-3/4" x 2.5"
401972V2300H	SPC-25-2001	1	20" x 2.5"
401972V2F90H	SPC-25-2005	5	20" x 2.5"
401972V2N80H	SPC-25-2010	10	20" x 2.5"
401972V2V20H	SPC-25-2020	20	20" x 2.5"
401972V2Z10H	SPC-25-2030	30	30" x 2.5"
401972V2BCOH	SPC-25-2050	50	20" x 2.5"
401972Z1300H	SPC-25-3001	1	30" x 2.5"
401972Z1F90H	SPC-25-3005	5	30" x 2.5"
401972Z1N80H	SPC-25-3010	10	30" x 2.5"
401972Z1V20H	SPC-25-3020	20	30" x 2.5"
401972Z1Z10H	SPC-25-3030	30	30" x 2.5"
401972Z1BCOH	SPC-25-3050	50	30" x 2.5"
401972AL300H	SPC-25-4001	1	40" x 2.5"
401972ALF90H	SPC-25-4005	5	40" x 2.5"
401972ALN80H	SPC-25-4010	10	40" x 2.5"
401972ALV20H	SPC-25-4020	20	40" x 2.5"
401972ALZ10H	SPC-25-4030	30	40" x 2.5"
401972ALBCOH	SPC-25-4050	50	40" x 2.5"
SPC SERIES—4.5" POLYESTER PLEATED CARTRIDGES			
401972N4300J	SPC-45-1001	1	9-3/4" x 4.5"
401972N4F90J	SPC-45-1005	5	9-3/4" x 4.5"
401972N4N80J	SPC-45-1010	10	9-3/4" x 4.5"
401972N4V20J	SPC-45-1020	20	9-3/4" x 4.5"
401972N4Z10J	SPC-45-1030	30	9-3/4" x 4.5"
401972N4BCOJ	SPC-45-1050	50	9-3/4" x 4.5"
401972V2300J	SPC-45-2001	1	20" x 4.5"
401972V2F90J	SPC-45-2005	5	20" x 4.5"
401972V2N80J	SPC-45-2010	10	20" x 4.5"
401972V2V20J	SPC-45-2020	20	20" x 4.5"
401972V2Z10J	SPC-45-2030	30	20" x 4.5"
401972V2BCOJ	SPC-45-2050	50	20" x 4.5"

PRICE BREAKS AVAILABLE

Shop supply.coreandmain.com to view price breaks on individual case purchases.



Core & Main NSF Carbon Block Filter



Manufactured with high-purity coconut shell carbon, these Carbon Block Filters are great for displacing traditional Granular Activated Carbon (GAC) and Powder Activated Carbon (PAC) filters in applications where high chlorine removal is needed. Carbon Block filters provide an excellent cost-to-performance value and are suitable for a wide range of residential, industrial and municipal applications. They are ideal for point-of-use or RO applications.

FEATURES & BENEFITS

- Carbon is coconut shell activated carbon
- Netting and endcaps are constructed from polypropylene
- Neoprene gaskets

C&M PART #	MFG PART #	NOMINAL MICRON RATING (μ)	LENGTH X DIAMETER
CB/SMCB SERIES—2.5" CARBON BLOCK FILTER CARTRIDGES			
401974F6F9OH	CB-25-0505	5	4-7/8" x 2.5"
401974M4F9OH	CB-25-0905	5	8-7/8" x 2.5"
4019745JOEOH	SMCB-2510	0.5	9-7/8" x 2.5"
4019745J30OH	CB-25-1001	1	9-7/8" x 2.5"
4019745JF9OH	CB-25-1005	5	9-7/8" x 2.5"
4019745JN8OH	CB-25-1010	10	9-7/8" x 2.5"
401974V2OEOH	SMCB-2520	0.5	20" x 2.5"
401974V230OH	CB-25-2001	1	20" x 2.5"
401974V2F9OH	CB-25-2005	5	20" x 2.5"
401974V2N8OH	CB-25-2010	10	20" x 2.5"
401974Z1F9OH	CB-25-3005	5	30" x 2.5"
CB/SMCB SERIES—2.5" CARBON BLOCK FILTER CARTRIDGES			
4019745JOEOJ	SMCB-4510	0.5	9-7/8" x 4.5"
4019745J30OJ	CB-45-1001	1	9-7/8" x 4.5"
4019745JF9OJ	CB-45-1005	5	9-7/8" x 4.5"
4019745JN8OJ	CB-45-1010	10	9-7/8" x 4.5"
401974V2OEOJ	SMCB-4520	0.5	20" x 4.5"
401974V230OJ	CB-45-2001	1	20" x 4.5"
401974V2F9OJ	CB-45-2005	5	20" x 4.5"
401974V2N8OJ	CB-45-2010	10	20" x 4.5"

HydroScientific™ Big Flow™ Filter Cartridges



These Big Flow™ Filter Cartridges are a high-quality alternative to Big Bubba™ cartridges. Big flow filter cartridges provide flow rates of up to 150 GPM and are designed to handle working pressures up to 125 PSI. They deliver high flow capacity while reducing filter change-outs. Their 100% binder-free material is ideal for use in applications where a durable, cleanable, reliable and reusable cartridge is required. Filters are available in pleated cartridge or depth cartridge configurations.

FEATURES & BENEFITS

- Cleanable and reusable
- Surfactant and binder free
- High flow rates

CERTIFICATIONS

- NSF/ANSI/CAN61 and NSF/ANSI 372 certified

SPECIFICATIONS

LENGTH	23"
OUTSIDE DIAMETER	6"
FILTER MEDIA	Polypropylene
END CAPS	Polypropylene
MAX OPERATING TEMPERATURE	125° F (52° C) - Synthetic Cartridge
MAX FLOW RATE	Pleated: 150 GPM Depth: 100 GPM
MAX WORKING PRESSURE	125 PSI

C&M PART #	MFG PART #	FILTER TYPE	NOMINAL MICRON RATING (μ)
40196130	HBBC-150-P1	Pleated	1
401961F9	HBBC-150-P5	Pleated	5
401961V2	HBBC-150-P20	Pleated	20
401961BC	HBBC-150-P50	Pleated	50
401961ED	HBBC-150-P150	Pleated	150
40196330	HBBC-150-D1	Depth	1
401963F9	HBBC-150-D5	Depth	5
401963V2	HBBC-150-D20	Depth	20
401963BC	HBBC-150-D50	Depth	50

Core & Main Pleated Synthetic Jumbo High Flow Filter Cartridges



These pleated jumbo cartridges are high flow performance cartridges designed to meet and exceed operational requirements in high flow applications. Their 100% polyester material is ideal for almost every application where a rugged, cleanable and reusable cartridge is required. They deliver high flow capability while reducing filter change-outs due to their high dirt holding capacity and increased particle removal. They are surfactant and binder free and incorporate a built-in seal.

FEATURES & BENEFITS

- Cleanable and reusable in most micron ratings and filtration applications
- Longer life, longer filter runs
- 100% Surfactant and binder free

CERTIFICATIONS

- NSF/ANSI/CAN61 and NSF/ANSI 372 certified; All materials comply with FDA requirements for Food & Beverage contact per CFR Title 21 174.5, 177.1520 and 177.1630; All components meet USP Class VI Plastics

SPECIFICATIONS

FILTER MEDIA (SYNTHETIC)	Pleated Polyester
FILTER MEDIA (ABSOLUTE)	Polypropylene
END CAPS (SYNTHETIC)	Plastisol
END CAPS (ABSOLUTE)	Polypropylene
CENTER TUBES (SYNTHETIC)	ABS or PVC
CENTER TUBES (ABSOLUTE)	Polypropylene
MAX. OPERATING TEMPERATURE	140°F (60°C) - Synthetic Cartridge 176°F (80°C) - All Poly Cartridge

C&M PART #	MFG PART #	NOMINAL MICRON RATING (μ)	LENGTH x DIAMETER	MATERIAL	MEDIA (sq/ft)
401962N26Z	HSC-40-0.2-PPA	0.22	7-3/4" x 9-5/8"	All Poly	40
401962N27A	HSC-40-0.35-PPA	0.35	7-3/4" x 9-5/8"	All Poly	40
401962N27B	HSC-40-0.45-PPA	0.45	7-3/4" x 9-5/8"	All Poly	40
401929N230	HSC-40-1	1	7-3/4" x 9-5/8"	Synthetic	40
401962N230	HSC-40-1-PPA	1	7-3/4" x 9-5/8"	All Poly	40
401929N2F9	HSC-40-5	5	7-3/4" x 9-5/8"	Synthetic	40
401929N2N8	HSC-40-10	10	7-3/4" x 9-5/8"	Synthetic	40
401929N2V2	HSC-40-20	20	7-3/4" x 9-5/8"	Synthetic	40
401929N2BC	HSC-40-50	50	7-3/4" x 9-5/8"	Synthetic	40
401929N2DG	HSC-40-100	100	7-3/4" x 9-5/8"	Synthetic	40
401929N2ED	HSC-40-150	150	7-3/4" x 9-5/8"	Synthetic	40
4019625K6Z	HSC-90-0.2-PPA	0.22	7-3/4" x 19-1/2"	All Poly	90
4019295K7A	HSC-90-0.35	0.35	7-3/4" x 19-1/2"	Synthetic	90
4019625K7A	HSC-90-0.35-PPA	0.35	7-3/4" x 19-1/2"	All Poly	90
4019625K7B	HSC-90-0.45-PPA	0.45	7-3/4" x 19-1/2"	All Poly	90
4019295K30	HSC-90-1	1	7-3/4" x 19-1/2"	Synthetic	90
4019625K30	HSC-90-1-PPA	1	7-3/4" x 19-1/2"	All Poly	90
4019295KF9	HSC-90-5	5	7-3/4" x 19-1/2"	Synthetic	90
4019295KN8	HSC-90-10	10	7-3/4" x 19-1/2"	Synthetic	90
4019295KV2	HSC-90-20	20	7-3/4" x 19-1/2"	Synthetic	90
4019295KBC	HSC-90-50	50	7-3/4" x 19-1/2"	Synthetic	90
4019295KDG	HSC-90-100	100	7-3/4" x 19-1/2"	Synthetic	90
4019295KED	HSC-90-150	150	7-3/4" x 19-1/2"	Synthetic	90
4019626Y6Z	HSC-170-0.2-PPA	0.22	7-3/4" x 30-3/4"	All Poly	170
4019296Y7A	HSC-170-0.35	0.35	7-3/4" x 30-3/4"	Synthetic	170
4019626Y7A	HSC-170-0.35PPA	0.35	7-3/4" x 30-3/4"	All Poly	170
4019626Y7B	HSC-170-0.45PPA	0.45	7-3/4" x 30-3/4"	All Poly	170
4019296Y30	HSC-170-1	1	7-3/4" x 30-3/4"	Synthetic	170
4019626Y30	HSC-170-1-PPA	1	7-3/4" x 30-3/4"	All Poly	170
4019296YF9	HSC-170-5	5	7-3/4" x 30-3/4"	Synthetic	170
4019296YN8	HSC-170-10	10	7-3/4" x 30-3/4"	Synthetic	170
4019296YV2	HSC-170-20	20	7-3/4" x 30-3/4"	Synthetic	170
4019296YBC	HSC-170-50	50	7-3/4" x 30-3/4"	Synthetic	170
4019296YDG	HSC-170-100	100	7-3/4" x 30-3/4"	Synthetic	170
4019296YED	HSC-170-150	150	7-3/4" x 30-3/4"	Synthetic	170

GET THE RIGHT FILTER

See **page 186** for a table showing the compatible filters for the filter housings we offer with the proper measurements for the different types of filters.



HydroScientific™ Commercial Plastic Filter Housings



Highly durable HF Series & HT Series Commercial Filter Housings accommodate 10" or 20" long cartridge filters. They have excellent chemical resistance and are ideal for many residential, commercial and light industrial applications. Select HT series housings for high temperature applications involving sea water, organic solvents, alcohol and vegetable oils.



CERTIFICATIONS

- NSF/ANSI Standard 42 for material and structural integrity only

SPECIFICATIONS

SERIES	HF5 SERIES	HF45 SERIES	HT SERIES
OPAQUE HOUSING	Polypropylene		Glass-Reinforced Nylon
CLEAR HOUSING	Polycarbonate	—	—
CAP	Polypropylene		Glass-Reinforced Nylon
BUTTON ASSEMBLY	SS, PP & Buna-N	SS, EPDM & PP	—
O-RING/GASKET	Buna-N		Viton®
MAX PRESSURE	100 psi (6.89 bar)	90 psi (6.21 bar)	125 psi (8.62 bar)
MAX TEMPERATURE	125°F (51.7°C)	100°F (37.7°C)	165°F (73.9°C)

REPLACEMENT PARTS & ACCESSORIES

C&M PART #	MFG PART #	DESCRIPTION
401951	HF5-ORING	O-Ring for HF5 Filter Housing
401952	HF45-ORING	O-Ring for HF45 Filter Housing
401954	HF5HT-ORING	O-Ring for HF5HT High Temp Filter Housing
401953	HF45HT-ORING	O-Ring for HF45HT High Temp Filter Housing

C&M PART #	MFG PART #	COLOR (BODY/CAP)	CONNECTIONS	LENGTH	PRESSURE RELIEF VALVE
A HF5 SERIES COMMERCIAL FILTER HOUSINGS FOR 2.5" DIAMETER FILTER					
401955190KN8	HF5-10BLBK34	Blue/Black	3/4"	10"	No
401955190LN8	HF5-10BLBK34PR	Blue/Black	3/4"	10"	Yes
401955390LN8	HF5-10CLBK34PR	Clear/Black	3/4"	10"	Yes
401955390KN8	HF5-10CLBK34	Clear/Black	3/4"	10"	No
401955190KV2	HF5-20BLBK34	Blue/Black	3/4"	20"	No
401955190LV2	HF5-20BLBK34PR	Blue/Black	3/4"	20"	Yes
401955390LV2	HF5-20CLBK34PR	Clear/Black	3/4"	20"	Yes
B HF45 SERIES COMMERCIAL FILTER HOUSINGS FOR 4.5" DIAMETER FILTER					
401956190KN8	HF45-10BLBK34	Blue/Black	3/4"	10"	No
401956190LN8	HF45-10BLBK34PR	Blue/Black	3/4"	10"	Yes
401956670LN8	HF45-10GRBK34PR	Grey/Black	3/4"	10"	Yes
401956190KV2	HF45-20BLBK34	Blue/Black	3/4"	20"	No
401956190LV2	HF45-20BLBK34PR	Blue/Black	3/4"	20"	Yes
401956190MN8	HF45-10BLBK10	Blue/Black	1"	10"	No
401956190NN8	HF45-10BLBK10PR	Blue/Black	1"	10"	Yes
401956670NN8	HF45-10GRBK10PR	Grey/Black	1"	10"	Yes
401956190MV2	HF45-20BLBK10	Blue/Black	1"	20"	No
401956190ON8	HF45-10BLBK15	Blue/Black	1-1/2"	10"	No
401956190PN8	HF45-10BLBK15PR	Blue/Black	1-1/2"	10"	Yes
401956670LV2	HF45-20GRBK34PR	Grey/Black	3/4"	20"	Yes
401956670NV2	HF45-20GRBK10PR	Grey/Black	1"	20"	Yes
401956190OV2	HF45-20BLBK15	Blue/Black	1-1/2"	20"	No
401956190PV2	HF45-20BLBK15PR	Blue/Black	1-1/2"	20"	Yes
401956390KN8	HF45-10CLBK34	Clear/Black	3/4"	10"	No
401956390LN8	HF45-10CLBK34PR	Clear/Black	3/4"	10"	Yes
401956390MN8	HF45-10CLBK10	Clear/Black	1"	10"	No
401956390ON8	HF45-10CLBK15	Clear/Black	1-1/2"	10"	No
401956390KV2	HF45-20CLBK34	Clear/Black	3/4"	20"	No
401956390LV2	HF45-20CLBK34PR	Clear/Black	3/4"	20"	Yes
401956390MV2	HF45-20CLBK10	Clear/Black	1"	20"	No
401956390NV2	HF45-20CLBK10PR	Clear/Black	1"	20"	Yes
401956390OV2	HF45-20CLBK15	Clear/Black	1-1/2"	20"	No
401956390PV2	HF45-20CLBK15PR	Clear/Black	1-1/2"	20"	Yes
401956170KN8	HF45-10BKBK34	Black/Black	3/4"	10"	No
401956170LN8	HF45-10BKBK34PR	Black/Black	3/4"	10"	Yes
401956170KV2	HF45-20BKBK34	Black/Black	3/4"	20"	No
401956170LV2	HF45-20BKBK34PR	Black/Black	3/4"	20"	Yes
401956170NN8	HF45-10BKBK10PR	Black/Black	1"	10"	Yes
401956170MV2	HF45-20BKBK10	Black/Black	1"	20"	No
401956170NV2	HF45-20BKBK10PR	Black/Black	1"	20"	Yes
C HF5HT SERIES HIGH-TEMP COMMERCIAL FILTER HOUSINGS FOR 2.5" DIAMETER FILTER					
4019750KN8OH	HF5HT-10RDRD34	Red/Red	3/4"	10"	No
4019750KV20H	HF5HT-20RDRD34	Red/Red	3/4"	20"	No
D HF45HT SERIES HIGH-TEMP COMMERCIAL FILTER HOUSINGS FOR 4.5" DIAMETER FILTER					
4019750MN80J	HF45HT-10RDBK10	Red/Black	1"	10"	No
4019750MV20J	HF45HT-20RDBK10	Red/Black	1"	20"	No
4019750OV20J	HF45HT-20RDBK15	Red/Black	1-1/2"	20"	No

HydroScientific™ Multi Round Filter Housings

These Multi Round Filter Housings are commonly used for pre-filtration reverse osmosis (RO), food service and agricultural applications. They are made of high grade stainless steel and accept a wide range of filter cartridges.

CERTIFICATIONS

- NSF/ANSI/CAN61 and NSF/ANSI 372 certified

SPECIFICATIONS

HOUSING SHELL	304 or 316 Stainless Steel
LID CLOSURE	Zinc Plated Steel
VENT & DRAIN PLUGS	304 or 316 Stainless Steel
HD MOUNTING LEGS	304 or 316 Stainless Steel
O-RING/GASKET	EPDM - FDA Grade
MAX PRESSURE	150 psi (10.3 bar)
MAX TEMPERATURE	300° F (149° C)



C&M PART #	MFG PART #	CONFIGURATION	PORTS/DRAINS	MAX FLOW (GPM)
MRH SERIES 304 SS SWING BOLT MULTI ROUND FILTER HOUSINGS				
4019570EN803	MRH-410-2	4 x 10" Filters	2" NPT(F) / 3/4" NPT(M)	28
4019570EV203	MRH-420-2	4 x 20" Filters	2" NPT(F) / 3/4" NPT(M)	56
4019570EZ103	MRH-430-2	4 x 30" Filters	2" NPT(F) / 3/4" NPT(M)	84
4019570EAL03	MRH-440-2	4 x 40" Filters	2" NPT(F) / 3/4" NPT(M)	112
4019570FN803	MRH-510-2	5 x 10" Filters	2" NPT(F) / 3/4" NPT(M)	35
4019570FV203	MRH-520-2	5 x 20" Filters	2" NPT(F) / 3/4" NPT(M)	70
4019570FZ103	MRH-530-2	5 x 30" Filters	2" NPT(F) / 3/4" NPT(M)	105
4019570FAL03	MRH-540-2	5 x 40" Filters	2" NPT(F) / 3/4" NPT(M)	140
4019570JN803	MRH-710-2	7 x 10" Filters	2" NPT(F) / 3/4" NPT(M)	49
4019570JV203	MRH-720-2	7 x 20" Filters	2" NPT(F) / 3/4" NPT(M)	98
4019570JZ103	MRH-730-2	7 x 30" Filters	2" NPT(F) / 3/4" NPT(M)	147
4019570JAL03	MRH-740-2	7 x 40" Filters	2" NPT(F) / 3/4" NPT(M)	196
MRHS SERIES 316 SS SWING BOLT MULTI ROUND FILTER HOUSINGS				
4019570EN804	MRHS-410-2	4 x 10" Filters	2" NPT(F) / 3/4" NPT(M)	28
4019570EV204	MRHS-420-2	4 x 20" Filters	2" NPT(F) / 3/4" NPT(M)	56
4019570EZ104	MRHS-430-2	4 x 30" Filters	2" NPT(F) / 3/4" NPT(M)	84
4019570EAL04	MRHS-440-2	4 x 40" Filters	2" NPT(F) / 3/4" NPT(M)	112
4019570FN804	MRHS-510-2	5 x 10" Filters	2" NPT(F) / 3/4" NPT(M)	35
4019570FV204	MRHS-520-2	5 x 20" Filters	2" NPT(F) / 3/4" NPT(M)	70
4019570FZ104	MRHS-530-2	5 x 30" Filters	2" NPT(F) / 3/4" NPT(M)	105
4019570FAL04	MRHS-540-2	5 x 40" Filters	2" NPT(F) / 3/4" NPT(M)	140
4019570JN804	MRHS-710-2	7 x 10" Filters	2" NPT(F) / 3/4" NPT(M)	49
4019570JV204	MRHS-720-2	7 x 20" Filters	2" NPT(F) / 3/4" NPT(M)	98
4019570JZ104	MRHS-730-2	7 x 30" Filters	2" NPT(F) / 3/4" NPT(M)	147
4019570JAL04	MRHS-740-2	7 x 40" Filters	2" NPT(F) / 3/4" NPT(M)	196

C&M PART #	MFG PART #	CONFIGURATION	PORTS/DRAINS	MAX FLOW (GPM)
MRH SERIES 304 SS BAND CLAMP MULTI ROUND FILTER HOUSINGS				
4019580EN803	MRH-410-2BC	4 x 10" Filters	2" NPT(F) / 3/4" NPT(M)	28
4019580EV203	MRH-420-2BC	4 x 20" Filters	2" NPT(F) / 3/4" NPT(M)	56
4019580EZ103	MRH-430-2BC	4 x 30" Filters	2" NPT(F) / 3/4" NPT(M)	84
4019580EAL03	MRH-440-2BC	4 x 40" Filters	2" NPT(F) / 3/4" NPT(M)	112
4019580FN803	MRH-510-2BC	5 x 10" Filters	2" NPT(F) / 3/4" NPT(M)	35
4019580FV203	MRH-520-2BC	5 x 20" Filters	2" NPT(F) / 3/4" NPT(M)	70
4019580FZ103	MRH-530-2BC	5 x 30" Filters	2" NPT(F) / 3/4" NPT(M)	105
4019580FAL03	MRH-540-2BC	5 x 40" Filters	2" NPT(F) / 3/4" NPT(M)	140
4019580JN803	MRH-710-2BC	7 x 10" Filters	2" NPT(F) / 3/4" NPT(M)	49
4019580JV203	MRH-720-2BC	7 x 20" Filters	2" NPT(F) / 3/4" NPT(M)	98
4019580JZ103	MRH-730-2BC	7 x 30" Filters	2" NPT(F) / 3/4" NPT(M)	147
4019580JAL03	MRH-740-2BC	7 x 40" Filters	2" NPT(F) / 3/4" NPT(M)	196
MRHS SERIES 316 SS BAND CLAMP MULTI ROUND FILTER HOUSINGS				
4019580EN804	MRHS-410-2BC	4 x 10" Filters	2" NPT(F) / 3/4" NPT(M)	28
4019580EV204	MRHS-420-2BC	4 x 20" Filters	2" NPT(F) / 3/4" NPT(M)	56
4019580EZ104	MRHS-430-2BC	4 x 30" Filters	2" NPT(F) / 3/4" NPT(M)	84
4019580EAL04	MRHS-440-2BC	4 x 40" Filters	2" NPT(F) / 3/4" NPT(M)	112
4019580FN804	MRHS-510-2BC	5 x 10" Filters	2" NPT(F) / 3/4" NPT(M)	35
4019580FV204	MRHS-520-2BC	5 x 20" Filters	2" NPT(F) / 3/4" NPT(M)	70
4019580FZ104	MRHS-530-2BC	5 x 30" Filters	2" NPT(F) / 3/4" NPT(M)	105
4019580FAL04	MRHS-540-2BC	5 x 40" Filters	2" NPT(F) / 3/4" NPT(M)	140
4019580JN804	MRHS-710-2BC	7 x 10" Filters	2" NPT(F) / 3/4" NPT(M)	49
4019580JV204	MRHS-720-2BC	7 x 20" Filters	2" NPT(F) / 3/4" NPT(M)	98
4019580JZ104	MRHS-730-2BC	7 x 30" Filters	2" NPT(F) / 3/4" NPT(M)	147
4019580JAL04	MRHS-740-2BC	7 x 40" Filters	2" NPT(F) / 3/4" NPT(M)	196

HydroScientific™ Band Clamp & Swing Bolt Jumbo Filter Housings

These durable Band Clamp and Swing Bolt Jumbo Filter Housings provide exceptional performance, quality and ease of use at a great price. They come with stainless steel standpipes as a standard feature and through their jumbo radial flow water entry, water enters the housing and forces water more effectively through the cartridge's pleated filter media.

FEATURES & BENEFITS

- Accepts jumbo style cartridges
- 304 or 316 stainless steel housing
- Stainless steel standpipe
- Electropolished and bead blasted finish
- Clean and dirty drains
- Clean and dirty gauge ports



Swing Bolt

Band Clamp

C&M PART #	MFG PART #	CONFIGURATION	MATERIAL	PORTS	MAX FLOW (GPM)
HBCJ SERIES—304 SS BAND CLAMP JUMBO FILTER HOUSINGS					
401945	HBCJ40	1 x 40 Media Jumbo Filter	304 SS	2" FNPT	50
401946	HBCJ90	1 x 90 Media Jumbo Filter	304 SS	2" FNPT	100
401947	HBCJ170	1 x 170 Media Jumbo Filter	304 SS	2" FNPT	150
HBCJ SERIES—316 SS BAND CLAMP JUMBO FILTER HOUSINGS					
401948	HBCJ40-316	1 x 40 Media Jumbo Filter	316 SS	2" FNPT	50
401949	HBCJ90-316	1 x 90 Media Jumbo Filter	316 SS	2" FNPT	100
401950	HBCJ170-316	1 x 170 Media Jumbo Filter	316 SS	2" FNPT	150
HSBJ SERIES—304 SS SWING BOLT JUMBO FILTER HOUSINGS					
4019310CN27C	HSBJ40	1 x 40 Media Jumbo Filter	304 SS	2" FNPT	50
4019310C5K7C	HSBJ90	1 x 90 Media Jumbo Filter	304 SS	2" FNPT	100
4019310C6Y7C	HSBJ170	1 x 170 Media Jumbo Filter	304 SS	2" FNPT	150
4019310D6Y7F	HSBJ170SB-3	3 x 170 Media Jumbo Filter	304 SS	4" Flange	450
4019310E6Y7G	HSBJ170SB-4	4 x 170 Media Jumbo Filter	304 SS	6" Flange	600
4019310F6Y7G	HSBJ170SB-5	5 x 170 Media Jumbo Filter	304 SS	6" Flange	750
4019310G6Y7G	HSBJ170SB-8	8 x 170 Media Jumbo Filter	304 SS	6" Flange	1200
4019310H6Y7I	HSBJ170SB-12	12 x 170 Media Jumbo Filter	304 SS	12" Flange	1800
4019310I6Y7I	HSBJ170SB-16	16 x 170 Media Jumbo Filter	304 SS	12" Flange	2400

SPECIFICATIONS

HOUSING SHELL	304 or 316 Stainless Steel
BAND CLAMP LID CLOSURE	304 or 316 Stainless Steel
SWING BOLT LID CLOSURE	Zinc Plated Steel
VENT AND DRAIN PLUGS	304 or 316 Stainless Steel
HEAVY-DUTY MOUNTING LEGS	304 or 316 Stainless Steel
O-RING/GASKET	EPDM – FDA Grade (Viton®, Silicone, and ERP Options)
MAX. PRESSURE RATING (BAND CLAMP)	150 psi @ 250° F (10.3 bar at 121° C)
MAX. PRESSURE RATING (SWING BOLT)	150 psi @ 300° F (10.3 bar at 149° C)

C&M PART #	MFG PART #	CONFIGURATION	MATERIAL	PORTS	MAX FLOW (GPM)
HSBJ SERIES—316 SS SWING BOLT JUMBO FILTER HOUSINGS					
4019320CN27C	HSBJ40-316	1 x 40 Media Jumbo Filter	316 SS	2" FNPT	50
4019320C5K7C	HSBJ90-316	1 x 90 Media Jumbo Filter	316 SS	2" FNPT	100
4019320C6Y7C	HSBJ170-316	1 x 170 Media Jumbo Filter	316 SS	2" FNPT	150
4019320D6Y7F	HSBJ170SB-3-316	3 x 170 Media Jumbo Filter	316 SS	4" Flange	450
4019320E6Y7G	HSBJ170SB-4-316	4 x 170 Media Jumbo Filter	316 SS	6" Flange	600
4019320F6Y7G	HSBJ170SB-5-316	5 x 170 Media Jumbo Filter	316 SS	6" Flange	750
4019320G6Y7G	HSBJ170SB-8-316	8 x 170 Media Jumbo Filter	316 SS	6" Flange	1200
4019320H6Y7I	HSBJ170SB12-316	12 x 170 Media Jumbo Filter	316 SS	12" Flange	1800
4019320I6Y7I	HSBJ170SB16-316	16 x 170 Media Jumbo Filter	316 SS	12" Flange	2400

HydroScientific™ High-Flow Filter Housings

Use these HF Series High-Flow Filter Housings as pre-filtration for RO systems, in food service, in car washes and many other applications where high-flow operation is required. These housings accept various high-flow filter cartridges.



FEATURES & BENEFITS

- Accepts high-flow cartridges
- Swing bolt design for fast, easy operation
- 304 or 316 stainless steel housing
- Stainless steel standpipe
- Accepts High Flow Cartridges
- Horizontal and vertical options
- Electropolish standard on all models

CERTIFICATIONS

- NSF/ANSI/CAN61 and NSF/ANSI 372 certified

SPECIFICATIONS

HOUSING SHELL	304 or 316 Stainless Steel
SWING BOLT LID CLOSURE	304 or 316 Stainless Steel
VENT AND DRAIN PLUGS	304 or 316 Stainless Steel
HEAVY-DUTY MOUNTING LEGS	304 or 316 Stainless Steel
O-RING/GASKET	EPDM - FDA Grade
MAX. PRESSURE RATING (SWING CLAMP)	150 psi @ 250 °F (10.3 bar at 121 °C)

C&M PART #	MFG PART #	CONFIGURATION	MATERIAL	PORTS	MAX FLOW (GPM)
HF SERIES—304 SS SWING BOLT HIGH FLOW FILTER HOUSINGS					
401964	HF2V-304-2F	1 x 20" Vertical	304 SS	2" Flange	100
401965	HF4V-304-3F	1 x 40" Vertical	304 SS	3" Flange	250
4019330CBR7E	HF6H-304-3F	1 x 60" Horizontal	304 SS	3" Flange	300
4019330DAL7G	HF4H-304-6F3	3 x 40" Horizontal	304 SS	6" Flange	800
4019330DBR7G	HF6H-304-6F3	3 x 60" Horizontal	304 SS	6" Flange	900
4019330EAL7G	HF4H-304-6F4	4 x 40" Horizontal	304 SS	6" Flange	1100
4019330EBR7G	HF6H-304-6F4	4 x 60" Horizontal	304 SS	6" Flange	1200
4019330JAL7H	HF4H-304-8F7	7 x 40" Horizontal	304 SS	8" Flange	1800
4019330JBR7H	HF6H-304-8F7	7 x 60" Horizontal	304 SS	8" Flange	2500
4019330HAL7I	HF4H-304-12F12	12 x 40" Horizontal	304 SS	12" Flange	3000
4019330HBR7I	HF6H-304-12F12	12 x 60" Horizontal	304 SS	12" Flange	3600
HF SERIES—316 SS SWING BOLT HIGH FLOW FILTER HOUSINGS					
401966	HF2V-316-2F	1 x 20" Vertical	316 SS	2" Flange	100
401967	HF4V-316-3F	1 x 40" Vertical	316 SS	3" Flange	250
4019340CBR7E	HF6H-316-3F	1 x 60" Horizontal	316 SS	3" Flange	300
4019340DAL7G	HF4H-316-6F3	3 x 40" Horizontal	316 SS	6" Flange	800
4019340DBR7G	HF6H-316-6F3	3 x 60" Horizontal	316 SS	6" Flange	900
4019340EAL7G	HF4H-316-6F4	4 x 40" Horizontal	316 SS	6" Flange	1100
4019340EBR7G	HF6H-316-6F4	4 x 60" Horizontal	316 SS	6" Flange	1200
4019340JAL7H	HF4H-316-8F7	7 x 40" Horizontal	316 SS	8" Flange	1800
4019340JBR7H	HF6H-316-8F7	7 x 60" Horizontal	316 SS	8" Flange	2500
4019340HAL7I	HF4H-316-12F12	12 x 40" Horizontal	316 SS	12" Flange	3000
4019340HBR7I	HF6H-316-12F12	12 x 60" Horizontal	316 SS	12" Flange	3600

GET THE RIGHT FILTER



See **page 186** for a table showing the compatible filters for the filter housings we offer with the proper measurements for the different types of filters.

HydroScientific SCICLONE™ Jumbo Filter Housings

The SCICLONE™ Jumbo Filter Housings separate dense solids prior to water passing through the filter cartridge, helping extend filter life, save on operation cost and increase dirt holding capacity. Water enters the housing through radial flow entry, which creates a cyclonic effect to prevent air entrapment and force water more effectively through pleated cartridge filters. SCICLONE™ filter housings are made of durable 304 stainless steel and come standard with stainless steel standpipes. Choose from single-filter and multi-filter configurations.



SPECIFICATIONS

HOUSING SHELL	304 Stainless Steel
LID CLOSURE	Zinc Plated Steel
VENT & DRAIN PLUGS	304 Stainless Steel
HD MOUNTING LEGS	304 Stainless Steel
O-RING/GASKET	EPDM – FDA Grade
MAX PRESSURE RATING	150 psi at 300°F
MAX TEMPERATURE	300°F (149°C)

FEATURES & BENEFITS

- Accepts jumbo style cartridges
- SCICLONE radial water flow entry design
- Swing bolt closure for quick and secure filter change
- Stainless steel standpipes

CERTIFICATIONS

- NSF/ANSI/CAN61 and NSF/ANSI 372 certified

C&M PART #	MFG PART #	CONFIGURATION	MATERIAL	PORTS	MAX FLOW (GPM)
4019350CN27K	SC40SB	1 x 40 Media Jumbo Filter	304 SS	2" Flange	50
4019350C5K7K	SC90SB	1 x 90 Media Jumbo Filter	304 SS	2" Flange	100
4019350C6Y7K	SC170SB	1 x 170 Media Jumbo Filter	304 SS	2" Flange	150
4019350D6Y7F	SC170SB-3	3 x 170 Media Jumbo Filter	304 SS	4" Flange	450
4019350E6Y7G	SC170SB-4	4 x 170 Media Jumbo Filter	304 SS	6" Flange	600
4019350F6Y7G	SC170SB-5	5 x 170 Media Jumbo Filter	304 SS	6" Flange	750
4019350G6Y7G	SC170SB-8	8 x 170 Media Jumbo Filter	304 SS	6" Flange	1200
4019350H6Y7I	SC170SB-12	12 x 170 Media Jumbo Filter	304 SS	12" Flange	1800
4019350I6Y7I	SC170SB-16	16 x 170 Media Jumbo Filter	304 SS	12" Flange	2400

Housings and Compatible Filters Table

Filter Housings	Compatible Filters	Compatible Measurements
BF/MF (Band Clamp & Swing Bolt Bag) Series Housings	Bag Filters	#1 (20 ; 17" Length) #2* (40 ; 32" Length) #3 (6 ; 8" Length) #4 (12 ; 14" Length)
HF (High Flow) Filter Housings	HF (High Flow) Filters	39.7 ; 20" Length 79.5 ; 40" Length 113.5 ; 60" Length
Band Clamp Jumbo Filter Housings	Pleated Jumbo High Flow Filters	40" sq ft Media 90" sq ft Media 170" sq ft Media
SCICLONE™ Jumbo Filter Housings	Pleated Jumbo High Flow Filters	40" sq ft Media 90" sq ft Media 170" sq ft Media
Swing Bolt Multi Round Filter Housings**	Absolute Rated Pleated Cartridges Sediment Depth Cartridges Polyester Pleated Cartridges String Wound Cartridges	10" Length 20" Length 30" Length 40" Length

*Most popular bag filter for Multi-bag Housings

**Housings will take any filters that have a 2.5" Diameter



Flow Metering



TABLE OF CONTENTS

Electromagnetic Flowmeters	188-190
Insertion Flow Meters, Mag	191-195
Insertion Flow Meters, Paddlewheel	196-197
Open Channel Flowmeters	198-199
Flowmeters	200-201
Water Meters & Accessories	202

McCrometer Dura Mag™ Electromagnetic Flowmeters

McCrometer's Dura Mag™ is the easy choice for tough applications. With a 5-year meter warranty and a 5-year battery life, Dura Mag eliminates the need for AC power connection while providing the easiest installation possible for a flanged mag flow meter. The meter is available to fit a common range of irrigation line sizes, from 1-1/2" to 12" diameter pipe. Dura Mag offers accuracy of ±1% with minimal upstream and downstream straight pipe required for most installations, all with the durability that customers have come to expect from McCrometer for over 65 years.

FEATURES & BENEFITS

- 5-year meter warranty
- 5-year battery warranty
- Lifetime liner guarantee
- Battery powered for easy installation – eliminate the hassle of cables or AC power
- Durable design – Proven in tough environments
- 10-minute DIY replaceable battery pack keeps your meter running
- Made in the USA

SPECIFICATIONS

ACCURACY	±1% of measured value ±0.006 ft/s (±0.0018 m/s)
OPERATING PRESSURE	150 psi
PROCESS CONNECTIONS	4" to 12" Steel flanged meters (Standard AWWA Class D 150# Rating)
DISPLAY	2-Line LCD display (no backlight), Non-volatile memory, Anti-reverse totalizer (standard), Total (to 9 digits of precision), Flow rate and velocity (to 5 digits of precision), Two alarms: low battery and empty pipe (optional), Opening lid activates display
*OUTPUTS	Digital output: Digital pulse (open collector) output for volumetric - Two isolated digital pulse (open collector) outputs for volumetric - AMI output Analog output: 4-20mA: Galvanically Isolated, 16 Bit resolution. All power configurations (including battery).
DATA LOGGER	Standard with all models, minimum of five years of data stored
**MATERIALS	Fusion-bonded epoxy coating eliminates risk of liner separation and water intrusion
OPERATING TEMPERATURE	-4° to 140° F (-20° to 60° C)
RATING	IP67 Die cast aluminum converter

* Note: 9-30 VDC loop power required (not supplied via converter)

** Liner is guaranteed against delamination, cracking, separation, or collapse within normal use guidelines for the lifetime of the meter.



CERTIFICATIONS

- ISO 9001:2015 certified quality management system, Certified by MET to UL 61010-1 / CSA C22.2 No. 61010-1, Certified to NSF / ANSI Standards
- Dura Mag is certified by IAPMO R&T to NSF/ANSI 61 for material safety and NSF/ANSI 372 for low lead content

C&M PART #	MFG PART #	SIZE	FLOW (GPM)	LENGTH	*WEIGHT (lbs)
DURA MAG ELECTROMAGNETIC FLOWMETER, VDC POWERED					
4020122F	DM04-ISMF1021-LS	4"	6.97 to 1110	13.4"	70
4020122G	DM06-ISMF1021-LS	6"	16.1 to 2560	14.6"	80
40201269	DM08-ISMF1021-LS	8"	29.2 to 4670	16.1"	115
40201271	DM10-ISMF1021-LS	10"	46.3 to 7400	18.5"	140
40201272	DM12-ISMF1021-LS	12"	67.3 to 10,760	19.7"	190
DURA MAG ELECTROMAGNETIC FLOWMETER, BATTERY POWERED					
4020132F	DM04-ISMB3221-LS	4"	6.97 to 1110	13.4"	70
4020132G	DM06-ISMB3221-LS	6"	16.1 to 2560	14.6"	80
40201369	DM08-ISMB3221-LS	8"	29.2 to 4670	16.1"	115
40201371	DM10-ISMB3221-LS	10"	46.3 to 7400	18.5"	140
40201372	DM12-ISMB3221-LS	12"	67.3 to 10,760	19.7"	190

*Shipping weights are estimated and may change due to specific order packaging

REPLACEMENT PARTS & ACCESSORIES

C&M PART #	MFG PART #	DESCRIPTION
402014	G3COM01	McLogger Software and Cable

Red Rubber 1/8" Full-Faced Flange Gasket & Bolt Packs



Flange packs are components used in various industries, particularly in piping systems and connections. They are designed to provide a secure and leak-proof connection between pipes or other equipment. Flange packs consist of red-rubber gasket, bolts and nuts.

C&M PART #	MFG PART #	SIZE	INCLUDES
ZINC-PLATED			
1021910150	100-275-00200	2"	1 red rubber gasket, 4 bolts and 4 nuts
1021910170	100-275-00220	2-1/2"	1 red rubber gasket, 4 bolts and 4 nuts
1021910187	100-275-00240	3"	1 red rubber gasket, 4 bolts and 4 nuts
10219101C1	100-275-00260	4"	1 red rubber gasket, 8 bolts and 8 nuts
10219101I2	100-275-00280	6"	1 red rubber gasket, 8 bolts and 8 nuts
10219101L1	100-275-00300	8"	1 red rubber gasket, 8 bolts and 8 nuts
10219101N8	100-275-00320	10"	1 red rubber gasket, 12 bolts and 12 nuts
10219101Q3	100-275-00340	12"	1 red rubber gasket, 12 bolts and 12 nuts

Rosemount 8750 Mag Meters

The Rosemount 8750W offers reliability and advanced process insight in an intuitive, easy-to-use solution specifically designed for utility flow measurement. This system is ideal for water distribution in any process plant, cooling and heating water, water management, influent and effluent flows, wastewater, and desalination, making it an economical solution for nearly any water- or utility-related application.

Ground rings expose more surface to the process; if currents flow, less noise will be produced, providing a more stable reference for the amplifier. Using two ground rings will provide a path to shunt the current around the fluid in the magmeter. Nonmetallic pipes require grounding rings (sold separately).

FEATURES & BENEFITS

- Welded coil housing provides protection against moisture ingress and sustained vibrations
- Dual compartment transmitter housing keeps the electronics fully isolated from moisture and contamination
- Sensor rated to IP68
- Electrode Coating Diagnostic indicates when preventive maintenance is needed to avoid unexpected downtime
- Tunable Empty Pipe Detection notifies user if the pipe is not full
- Easiest-to-use LOI with dedicated keys for configuration

SPECIFICATIONS

ACCURACY	±0.5%
OUTPUT	Pulse and 4-20 mA (HART® Protocol) Signals, Passive or Active (User-Selectable)
CONDUCTIVITY	≥5 µS/cm
WORKING PRESSURE	285 psi @ 100°F
TEMPERATURE RANGE	0 to 140°F
PROCESS CONNECTIONS	Class 150, ANSI
DISPLAY	Backlit Alphanumeric LCD Integral: 2 Lines x 16 Characters Remote-mount: 2 Lines x 20 Characters
MATERIALS	Tube Lining: Polyurethane Transmitter Housing: Aluminum, NEMA 4X Electrodes: 316L Stainless-Steel Tube Flange: Carbon Steel
POWER	90-250 VAC, 50-60 Hz

MINIMUM/MAXIMUM FLOW RATES (GPM)

PIPE SIZE	AT 1 FT/S (MIN RANGE SETTING)	AT 3 FT/S	AT 39.37 FT/S (MAX RANGE SETTING)
1"	2.694	8.081	106.05
2"	10.459	31.38	411.77
3"	23.042	69.13	907.17
4"	39.679	119.04	1562.2
6"	90.048	270.14	3545.2
8"	155.93	467.79	6138.9
10"	245.78	737.34	9676.3
12"	352.51	1057.5	13,878



C&M PART #	MFG PART #	SIZE	LENGTH
FLOWMETERS WITH INTEGRAL TRANSMITTER (NO DISPLAY)			
4016230113	8750WDMT1A1FPSA010CA1	1"	7.88"
4016230250	8750WDMT1A1FPSA020CA1	2"	7.87"
4016230112	8750WDMT1A1FPSA030CA1	3"	7.87"
40162302C1	8750WDMT1A1FPSA040CA1	4"	9.84"
4016230212	8750WDMT1A1FPSA060CA1	6"	11.73"
40162302L1	8750WDMT1A1FPSA080CA1	8"	13.65"
40162302N8	8750WDMT1A1FPSA100CA1	10"	17.73"
40162302Q3	8750WDMT1A1FPSA120CA1	12"	19.70"
FLOWMETERS WITH INTEGRAL TRANSMITTER (WITH DISPLAY/LOI)			
4016230330	8750WDMT1A1FPSA010CAIM4	1"	7.88"
4016230350	8750WDMT1A1FPSA020CAIM4	2"	7.87"
4016230387	8750WDMT1A1FPSA030CAIM4	3"	7.87"
40162303C1	8750WDMT1A1FPSA040CAIM4	4"	9.84"
4016230312	8750WDMT1A1FPSA060CAIM4	6"	11.73"
40162303L1	8750WDMT1A1FPSA080CAIM4	8"	13.65"
40162303N8	8750WDMT1A1FPSA100CAIM4	10"	17.73"
40162303Q3	8750WDMT1A1FPSA120CAIM4	12"	19.70"
FLOWMETERS WITH REMOTE-MOUNT TRANSMITTER			
40162430	8750WDMR1A1FPSA010CA1	1"	7.88"
40162450	8750WDMR1A1FPSA020CA1	2"	7.87"
40162487	8750WDMR1A1FPSA030CA1	3"	7.87"
401624C1	8750WDMR1A1FPSA040CA1	4"	9.84"
401624I2	8750WDMR1A1FPSA060CA1	6"	11.73"
401624L1	8750WDMR1A1FPSA080CA1	8"	13.65"
401624N8	8750WDMR1A1FPSA100CA1	10"	17.73"
401624Q3	8750WDMR1A1FPSA120CA1	12"	19.70"

REPLACEMENT PARTS & ACCESSORIES

C&M PART #	MFG PART #	DESCRIPTION
401625	08732-0065-2001	30-FT Cable, Connects Mag Meter Transmitter to Flow Tube
40162630	8705-3019-0100	Rosemount Grounding Rings, 316L SS, Pair, 1"
40162650	8705-3019-0200	Rosemount Grounding Rings, 316L SS, Pair, 2"
40162687	8705-3019-0300	Rosemount Grounding Rings, 316L SS, Pair, 3"
401626C1	8705-3019-0400	Rosemount Grounding Rings, 316L SS, Pair, 4"
401626I2	8705-3019-0600	Rosemount Grounding Rings, 316L SS, Pair, 6"
401626L1	8705-3019-0800	Rosemount Grounding Rings, 316L SS, Pair, 8"
401626N8	8705-3019-1000	Rosemount Grounding Rings, 316L SS, Pair, 10"
401626Q3	8705-3019-1200	Rosemount Grounding Rings, 316L SS, Pair, 12"



Seametrics iMAG Electromagnetic Flowmeters

The iMAG-Series Electromagnetic Flowmeters are the most economical flanged flowmeters on the market. They feature electrodes designed to discourage fouling, and are available in 2 to 12" pipe sizes—great for municipal or industrial water, waste and reclaimed water, pump stations, pump skids and packaged plant applications.

Select flowmeters with mounted or remote display. Flow rate/total indication and pulse output are standard on all units. Easily set rate/total units and pulse scaling via the front panel touch keypad. Bidirectional flow reading is standard with totals available in forward total, reverse total, net flow total, batch forward flow total, and batch reverse flow total. Flowmeters only require straight 2x pipe diameter upstream and 1x pipe diameter downstream—ideal for installing in locations with tight plumbing spaces.

FEATURES & BENEFITS

- Easy setup via two touch sensor buttons on keypad/on screen prompts
- View flow rate and total on display
- Pulse output standard on all models
- Minimal straight pipe required
- No moving parts
- IP68 rated

INCLUDES

Pair of full-faced gaskets

Note: It is recommended to use a pair of grounding rings for nonmetallic pipe applications.

SPECIFICATIONS

ACCURACY	Battery-Powered Models: ±1.0% All Other Models: ±0.75% of Reading ±0.025% of Full-Scale Flow
LOW-FLOW CUTOFF	0.5% of Max Flow Rate
DISPLAY	128 x 64 Dot-Matrix LCD
RATE UNITS	Gallons, Liters, Barrels, Cu Feet, Cu Meters, Million Gallons, Mega Liters, Imperial Gallons & Million Imperial Gallons per Second/Minute/Hour/Day
OUTPUT	4700p: 4 to 20 mA current loop, 24 VDC 4700p & 4700r: Pulse (DC & Battery) User-Scalable Pulse, Current Sinking, 36 VDC Max
CONDUCTIVITY	>20 µS/cm (Empty Pipe Detection)
WORKING PRESSURE	150 psi
PROCESS CONNECTION	ANSI 150 lbs. Flanged
MATERIALS	Body/Flow Tube: Epoxy Coated Welded Steel 2", 3" & 8" Liner: Polyurethane/Noryl® 4", 6", 10" & 12" Liner: Santoprene® Flange with Polypropylene Liner Body Electronics Housing: Die-Cast Aluminum Electrodes: 316 Stainless Steel
POWER	Battery Powered Flowmeters: One Lithium 7.2 V 'D' Size Battery Pack, Replaceable (Up to 8 Years of Battery Life Dependent on Sampling Rates) DC Powered Flowmeters: 9 to 36 VDC @ 250 mA max AC Powered Flowmeters: 100 to 240 VAC, 50/60 Hz
BATTERY BACKUP (NOT FOR PRIMARY POWER)	DC Powered Flowmeters: One Lithium 7.2 V 'D' Size Battery Pack, Replaceable AC Powered Flowmeters: One 9 V Alkaline Battery, Replaceable
CABLE	Power/Output Cable: 20 ft, Polyurethane Jacket Remote Display Cable (iMAG 4700r): 20 ft
WORKING TEMPERATURES	10 to 130°F (-12 to 54°C)
CERTIFICATIONS	NSF 61 approved; IP68 rated, CSA



BATTERY POWERED iMAG FLOWMETER

C&M PART #	MFG PART #	SIZE	FLOW (GPM)	LENGTH
11009050	iMAG4700-0200-F1-P-BX-X-XX-0064	2"	2.0 to 321	7.9"
11009087	iMAG4700-0300-F1-P-BX-X-XX-0064	3"	4.0 to 722	7.9"
110090C1	iMAG4700-0400-F1-P-BX-X-XX-0064	4"	6.43 to 1285	10.24"
110090I2	iMAG4700-0600-F1-P-BX-X-XX-0064	6"	14.5 to 2891	12.27"
110090L1	iMAG4700-0800-F1-P-BX-X-XX-0064	8"	26 to 5140	14.24"
110090N8	iMAG4700-1000-F1-P-BX-X-XX-0064	10"	40 to 8031	18.18"
110090Q3	iMAG4700-1200-F1-P-BX-X-XX-0064	12"	58 to 11,565	19.68"

DC POWERED iMAG FLOWMETER

C&M PART #	MFG PART #	SIZE	FLOW (GPM)	LENGTH
METERS WITH INTEGRAL DISPLAY				
11009750	iMAG4700p-0200-F1-P-D1-X-XX-006S	2"	2.0 to 321	7.9"
11009787	iMAG4700p-0300-F1-P-D1-X-XX-006S	3"	4.0 to 722	7.9"
110097C1	iMAG4700p-0400-F1-P-D1-X-XX-006S	4"	6.43 to 1285	10.24"
110097I2	iMAG4700p-0600-F1-P-D1-X-XX-006S	6"	14.5 to 2891	12.27"
110097L1	iMAG4700p-0800-F1-P-D1-X-XX-006S	8"	26 to 5140	14.24"
110097N8	iMAG4700p-1000-F1-P-D1-X-XX-006S	10"	40 to 8031	18.18"
110097Q3	iMAG4700p-1200-F1-P-D1-X-XX-006S	12"	58 to 11,565	19.68"
METERS WITH REMOTE DISPLAY				
11010450	iMAG4700r-0200-F1-P-D1-X-XX-006S-006	2"	2.0 to 321	7.9"
11010487	iMAG4700r-0300-F1-P-D1-X-XX-006S-006	3"	4.0 to 722	7.9"
110104C1	iMAG4700r-0400-F1-P-D1-X-XX-006S-006	4"	6.43 to 1285	10.24"
110104I2	iMAG4700r-0600-F1-P-D1-X-XX-006S-006	6"	14.5 to 2891	12.27"
110104L1	iMAG4700r-0800-F1-P-D1-X-XX-006S-006	8"	26 to 5140	14.24"
110104N8	iMAG4700r-1000-F1-P-D1-X-XX-006S-006	10"	40 to 8031	18.18"
110104Q3	iMAG4700r-1200-F1-P-D1-X-XX-006S-006	12"	58 to 11,565	19.68"

AC POWERED iMAG FLOWMETER

C&M PART #	MFG PART #	SIZE	FLOW (GPM)	LENGTH
METERS WITH INTEGRAL DISPLAY				
11011150	iMAG4700p-0200-F1-P-A1-X-XX-006S	2"	2.0 to 321	7.9"
11011187	iMAG4700p-0300-F1-P-A1-X-XX-006S	3"	4.0 to 722	7.9"
110111C1	iMAG4700p-0400-F1-P-A1-X-XX-006S	4"	6.43 to 1285	10.24"
110111I2	iMAG4700p-0600-F1-P-A1-X-XX-006S	6"	14.5 to 2891	12.27"
110111L1	iMAG4700p-0800-F1-P-A1-X-XX-006S	8"	26 to 5140	14.24"
110111N8	iMAG4700p-1000-F1-P-A1-X-XX-006S	10"	40 to 8031	18.18"
110111Q3	iMAG4700p-1200-F1-P-A1-X-XX-006S	12"	58 to 11,565	19.68"
METERS WITH REMOTE DISPLAY				
11011850	iMAG4700r-0200-F1-P-A1-X-L-XX-006S-006	2"	2.0 to 321	7.9"
11011887	iMAG4700r-0300-F1-P-A1-X-L-XX-006S-006	3"	4.0 to 722	7.9"
110118C1	iMAG4700r-0400-F1-P-A1-X-L-XX-006S-006	4"	6.43 to 1285	10.24"
110118I2	iMAG4700r-0600-F1-P-A1-X-L-XX-006S-006	6"	14.5 to 2891	12.27"
110118L1	iMAG4700r-0800-F1-P-A1-X-L-XX-006S-006	8"	26 to 5140	14.24"
110118N8	iMAG4700r-1000-F1-P-A1-X-L-XX-006S-006	10"	40 to 8031	18.18"
110118Q3	iMAG4700r-1200-F1-P-A1-X-L-XX-006S-006	12"	58 to 11,565	19.68"



McCrometer SPI Electromagnetic Flow Meter

Ideal for Clean or Dirty Water Flow Measurement

Electromagnetic Insertion Meter for Municipal and Industrial Flow Applications.

The SPI Mag Insertion Flow Meter provides a highly cost-effective solution for the accurate measurement of liquid flow in closed conduit, pressurized pipe applications. Unlike conventional magnetic meters, the SPI Mag's cost is independent of pipe size.

Velocity and pipe diameter information are utilized by the SPI Mag to determine flow over wide flow ranges with a high degree of accuracy.

The SPI Mag reliably measures flow in water and wastewater as well as any type of industrial flow processes involving conductive fluids such as potable water, slurries, sludge, cooling water, and pulp stock.

- Proven electromagnetic technology based on Faraday's Law
- Debris shedding, self-cleaning sensor eliminates costly maintenance.
- The cost is independent of line size.
- Easy Hot Tap Installation - no interruption of flow process
 - » Nominal pipe size availability
 - » Reverse flow indication

SPECIFICATIONS

MEASUREMENT	Volumetric flow in filled flow conduits 2" to 96" ID utilizing insertable velocity sensor. 1" meter = 2" to 30" ID Pipe, 2" meter = 6" to 96" ID Pipe
FLOW MEASUREMENT	Method: Electromagnetic Accuracy: ±2% of reading ±0.03 ft/s, 0 stability from 0.3 to 20 ft/s velocity range Velocity Range: 0.3 to 30 ft/s Direction measurement: Has reverse flow indication
CONDUCTIVITY	5µS/cm (Minimum)
POWER	AC: 90-265V, 45-66 Hz or DC: 10-35V
MATERIALS (EXPOSED TO FLOW)	Sensor: Polyurethane 2" Sensor Mounting: PVC and Stainless Steel (Optional) Compression Seal: Buna-N O-Ring
OUTPUTS	Dual 4-20mA: galvanically isolated and fully programmable for zero & full scale Four digital programmable: Open collector transistor usable for pulse, frequency, or alarm settings
ALARMS	Volumetric Pulse, Flow Rate (Frequency), Hardware Alarm, High/Low Flow Alarms, Empty Pipe, Directional Indication, Range Indication
CONVERTER DIMENSIONS	5.75"H x 5.75"W x 6.69"D
ELECTRICAL CONNECTIONS	Compression gland seals for 1/8" to 3/8" diameter round cable
ISOLATION	Galvanic separation to 50VDC between analog, pulse/alarm, and earth/ground
KEYPAD/DISPLAY	Access and change set-up parameters using three membrane keys/LCD display
PRESSURE/TEMPERATURE	PVC Insertion Tube: Up to 105°F at 150 PSI Stainless Steel Insertion Tube: Up to 160°F at 250 PSI (recommended) Electronics: -4° to 140°F (operating and storage)
RATINGS	IP67 Die Cast Aluminum Converter; CE Certified (Converter Only) IP68 submersible sensor



INSERTION TUBE

- Divide the pipe ID by 8 and add 18" to determine the insertion tube length for typical near wall installations.
- To complete a full profile analysis, you must request an insertion tube 18" longer than the pipe ID (recommended).
- Rods and mounting hardware included with tube assemblies.

1"	Stainless Steel Tube, 12" Length, Will Profile 4" Pipe ID
	Stainless Steel Tube, 24" Length, Will Profile 16" Pipe ID
	Stainless Steel Tube, 36" Length, Will Profile 28" Pipe ID
*2"	PVC Tube, 18" Length, Will Profile 10" Pipe ID
	PVC Tube, 24" Length, Will Profile 16" Pipe ID
	PVC Tube, 30" Length, Will Profile 22" Pipe ID

*Optional: Stainless Steel Tube, Specify Length up to 65" Maximum

OPTIONS

- DC Power
- Sun Shield
- ID Tag (Stainless Steel)
- Valves
- Sensor Cable up to 200-ft additional (Consult factory for longer lengths)
- Sensor Insertion Tool

Ordering Information

(Please provide the following when placing order):

- Model and Tap Size
- Insertion Tube Length
- Fluid
- Pipe ID
- Pressure
- Cable Length
- Min. Flow
- Max. Flow
- Temperature
- All Chemicals in Use
- Typical Flow
- Indicator and Totalizer Units

Please call Core & Main Supply at 1-888-885-2673 to talk with our Product Specialist Team about application and ordering information.



Pipe & Water Meter Support Stands

Trumbull saddle & flange style adjustable pipe supports are standard stock saddles that are formed to fit ductile iron pipe diameters, other pipe diameters available upon request. All supports have an electro-galvanized finish. Other coatings, such as epoxy paint, may be available; please inquire as to availability. Optional 316 stainless steel supports are also available.

FEATURES & BENEFITS

- Saddle Type Support - Large base (1/4" x 8" x 8")
- Flange Type Support - Large base (1/4" x 4" x 6")
- Saddle assembly and height-adjustment cap, which allows for up to 3" of final adjustment.
- Extension Pipe Size is 2" Sch 40



SPECIFICATIONS

	CARBON STEEL	304 STAINLESS STEEL
BASE PLATE	ASTM A36 sheet steel	ASTM 304 sheet steel
THREADED ROD	ASTM A307 rolled threads	ASTM 304 rolled threads
BASE CUP	ASTM A53 tubing	ASTM 304 tubing
ADJUSTMENT CAP	ASTM A53 tubing	ASTM 304 tubing
SADDLE	ASTM A36 sheet metal	ASTM 304 sheet metal

C&M PART #	MFG PART #	PIPE SIZE	SADDLE SIZE	THREAD ROD	MIN. HEIGHT FROM FLOOR
CARBON STEEL SADDLE TYPE PIPE SUPPORT					
11194887	364-5850	3"	1-1/2" x 3/8"	1"-8 NC x 6"	7"
111948C1	364-5851	4"	1-1/2" x 3/8"	1"-8 NC x 6"	7"
111948I2	364-5852	6"	2" x 1/2"	1"-8 NC x 6"	7"
111948L1	364-5853	8"	2" x 1/2"	1"-8 NC x 6"	7"
111948N8	364-5854	10"	2" x 1/2"	1"-8 NC x 6"	7"
111948Q3	364-5855	12"	2" x 1/2"	1"-8 NC x 6"	7"
304 STAINLESS STEEL SADDLE TYPE PIPE SUPPORT					
11194987	364-5830	3"	1-1/2" x 3/8"	1"-8 NC x 6"	7"
111949C1	364-5831	4"	1-1/2" x 3/8"	1"-8 NC x 6"	7"
111949I2	364-5832	6"	2" x 1/2"	1"-8 NC x 6"	7"
111949L1	364-5833	8"	2" x 1/2"	1"-8 NC x 6"	7"
111949N8	364-5834	10"	2" x 1/2"	1"-8 NC x 6"	7"
111949Q3	364-5835	12"	2" x 1/2"	1"-8 NC x 6"	7"
CARBON STEEL FLANGED TYPE PIPE SUPPORT					
11195087	364-5870	3"	6" x 3-1/4" x 1/4"	1"-8 NC x 6"	7"
111950C1	364-5871	4"	4-1/2" x 2-1/2" x 1/4"	1"-8 NC x 6"	7"
111950I2	364-5872	6"	5-1/4" x 2-1/2" x 1/4"	1"-8 NC x 6"	7"
111950L1	364-5873	8"	6-1/2" x 2-1/2" x 1/4"	1"-8 NC x 6"	7"
111950N8	364-5874	10"	6" x 2-1/2" x 1/4"	1"-8 NC x 6"	7"
111950Q3	364-5875	12"	6-1/2" x 2-1/2" x 1/4"	1"-8 NC x 6"	7"
304 STAINLESS STEEL FLANGED TYPE PIPE SUPPORT					
11195187	364-5890	3"	6" x 3-1/4" x 1/4"	1"-8 NC x 6"	7"
111951C1	364-5891	4"	4-1/2" x 2-1/2" x 1/4"	1"-8 NC x 6"	7"
111951I2	364-5892	6"	5-1/4" x 2-1/2" x 1/4"	1"-8 NC x 6"	7"
111951L1	364-5893	8"	6-1/2" x 2-1/2" x 1/4"	1"-8 NC x 6"	7"
111951N8	364-5894	10"	6" x 2-1/2" x 1/4"	1"-8 NC x 6"	7"
111951Q3	364-5895	12"	6-1/2" x 2-1/2" x 1/4"	1"-8 NC x 6"	7"

Seametrics® Wall-Mount Flow Monitors/Totalizers

The microcontroller-based FT-Series Flow Monitor/Totalizers interface with pulse output flow sensors to compute and display flow rate, flow total, and generate output signals representing flow. Use the pulse and 4 to 20 mA outputs to control external devices such as metering pumps and water treatment controls. These flow meters can be password protected to prevent resetting the total or changing configuration settings.



FEATURES & BENEFITS

- Simple setup
- Rugged plastic housing
- Nonvolatile memory
- Direct replacement for legacy FT415 and FT420 models

SPECIFICATIONS

DISPLAY	2-Line LCD (Rate: 5-Digit; Totalizer: 8-Digit)
RATE UNITS	Gallons, Liters, Cu/Ft, Cu/Meter, Fluid oz per Second/Minute/Hour/Day, Million Gallons per Day, Mega Liters, Miner's Inches
TOTAL UNITS	Gallons, Gallons x 1000, Liters, Cu/Ft, Cu/Ft x 1000, Cu/Meter, Fluid Oz, Million Gallons, Mega Liters, Miner's Inch per Day, Acre Feet, Acre Inch
SENSOR INPUT	FT430 & FT440: 5-VDC Pulse Frequency or Contact Closure, 2000 Hz (Max) FT450: Micro-Power GMR Sensor (Square Wave), 550 Hz (Max)
ANALOG OUTPUT	FT440: 4 to 20 mA, 2-Wire Loop FT430 & FT450: None
PULSE OUTPUT	2 (Either 1 or 2 Scalable, Varies by Model)
PULSE RANGE	0.1 to 99,999.9 Units/Pulse
DATA LOGGER	Integral as an Option on Select Models, Capacity Varies by Configurable Cycle Time, Mini-USB Port for Data Retrieval
OPERATING TEMPERATURE	-32 to 131°F (0 to 55°C)
ENCLOSURE	NEMA 4X, IP67 Industrial-Grade Plastic, Wall Mount
POWER	FT430: 7 to 30 VDC FT440: 9 to 30 FDC (Loop Powered with 4 to 20 mA Output) FT450: 3.6 V Li-Ion 'C' Battery, Replaceable
DIMENSIONS (L x W x D)	4.3" x 4.7" x 3.37"

C&M PART #	MFG PART #	DESCRIPTION	OUTPUTS	BUILT-IN DUAL POWER SUPPLY
401357	FT430W	VDC Powered	(2) Pulse	None
401358*	FT430W-139	VDC Powered	(2) Pulse	120/240 VAC Input, 12/24 VDC Outputs
401359	FT440W	Loop Powered	(2) Pulse, (1) Analog	None
401360*	FT440W-139	Loop Powered	(2) Pulse, (1) Analog	120/240 VAC Input, 12/24 VDC Outputs
401361	FT450W	Battery Powered	(2) Pulse	None

REPLACEMENT PARTS & ACCESSORIES

C&M PART #	MFG PART #	DESCRIPTION
401404	PC42	115/230 VAC Dual Power Supply (12/24VDC output) with Power Cord

Seametrics® Adjustable-Depth Insertion Electromagnetic Flow Sensors

The EX100/200-Series Adjustable-Depth Insertion Electromagnetic Flow Sensors have no moving parts, providing reliable measurements for both clean or turbid water. Meter extends only about 1/8 of pipe diameter, minimizing potential clogging with debris. 316 stainless steel (SS) or brass body withstands a variety of temperature, pressure and chemical conditions. Installation requires 1-1/2" or 2" NPT(F) threaded fitting such as a pipe saddle.

Send the pulse output to a PLC or a FT-series flow monitor/totalizer for flow rate/total display and optional 4 to 20 mA output. Use FT430 monitor/totalizer for basic rate/total and pulse output; use FT440 monitor/totalizer for analog output and display of rate and total. Select EX150/EX250 "hot tap" models to install or service without shutting down the line. They use a 2" NPT(M) isolation valve (included) with a nipple for installation on the pipe fitting; no special tool is required.

FEATURES & BENEFITS

- Reliable, no moving parts
- Depth adjustable sensor
- Use Brass models for nonpotable water applications.
- Use for "full pipe" applications
- Works with FT430 or FT440 monitor/totalizers

Note: For a complete system, order flow monitor/totalizer, service saddle and power supply separately.

SPECIFICATIONS

ACCURACY	±1% Full Scale
FLOW VELOCITY RANGE	0.2 to 20 fps
OUTPUT	Square Wave Pulse, Optoisolated
MATERIALS	Sensor: 316 SS or Brass Electrode Plate: PVDF Electrodes: Hastelloy® Housing: Cast Aluminum, Powder Coated
MAX PRESSURE	200 psi
OPERATING TEMPERATURES	32 to 200°F
POWER	12 to 25 VDC, 250 mA minimum
SENSOR CABLE	18-ft Length



INSERTION MAG METER FLOW RATES

PIPE SIZE	3"	4"	6"	8"	10"	12"	16"	24"	48"
MINIMUM FLOW (GPM)	6	11	25	44	69	99	175	395	1580
MAXIMUM FLOW (GPM)	440	783	1162	3133	4895	7050	12,533	28,200	112,804

C&M PART #	MFG PART #	PIPE SIZE	FITTING SIZE	BODY	ISOLATION VALVE
INSERTION ELECTROMAGNETIC WITH STANDARD FLOW SENSOR					
401336	EX110B	3 to 10"	1-1/2" NPT	Brass	N/A
401337	EX110S	3 to 10"	1-1/2" NPT	316 SS	N/A
401341	EX210B	10 to 48"	1-1/2" NPT	Brass	N/A
401342	EX210S	10 to 48"	1-1/2" NPT	316 SS	N/A
INSERTION ELECTROMAGNETIC WITH HOT TAP FLOW SENSOR					
401338	EX150B	3 to 10"	2" NPT	Brass	Bronze
401339	EX150S	3 to 10"	2" NPT	316 SS	Bronze
401340	EX150S-08	3 to 10"	2" NPT	316 SS	316 SS
401343	EX250B	10 to 48"	2" NPT	Brass	Bronze
401344	EX250S	10 to 48"	2" NPT	316 SS	Bronze
401345	EX250S-08	10 to 48"	2" NPT	316 SS	316 SS

REPLACEMENT PARTS & ACCESSORIES

C&M PART #	MFG PART #	DESCRIPTION
401404	PC42	115/230 VAC Dual Power Supply (12/24 VDC output) with Power Cord



Helpful Tip: Meter Positioning

Positioning the Meter for best results, the Seametrics EX100/200 sensor should be installed with at least ten diameters of straight pipe upstream and five downstream. Certain extreme situations such as partially-opened valves are particularly difficult and may require more straight diameters upstream.

When a magmeter is used in a chemical injection application, the chemical line must be placed downstream of the magmeter OR far enough upstream for complete mixing to occur before the fluid reaches the meter. When unmixed chemical alternates with water passing through the meter, the rapid changes in conductivity may cause sudden spikes and drops in the meter's reading, resulting in inaccurate measurement. The magmeter will restabilize, however, with a steady flow of fluid of uniform conductivity.

Seametrics® Fixed-Depth Insertion Electromagnetic Flow Sensors

The EX-800-Series Fixed-Depth Insertion Electromagnetic Flow Sensors have no moving parts and can reliably measure conductive liquids in 1 to 12" pipe sizes. These flow sensors provide you with low-flow performance and accuracy superior to any mechanical flow sensor. Meter extends only about 1/8 of pipe diameter, minimizing potential clogging with debris. Send the pulse output to a PLC or a FT-series flow monitor/totalizer for flow rate/total display and optional 4 to 20 mA output. Use FT430 monitor/totalizer for basic rate/total and pulse output; use FT440 monitor/totalizer for analog output and display of rate and total.

These flow sensors require special fittings that ensure correct depth placement in the pipe—order separately. Fittings come in a variety of materials for compatibility with specific applications. Tee fittings are individually wet calibrated at the factory and marked with the K-factor (pulses per gallon). Saddle fittings must be field-installed on the pipe and do not come wet-calibrated. K-factors for saddles are based on factory-testing.

FEATURES & BENEFITS

- Reliable, no moving parts
- Easy to install and maintain
- Dedicated fittings for simplicity, retainer clip automatically sets correct flow sensor depth.
- Use for “full pipe” applications
- Use stainless steel model for potable water applications
- Works with FT430 or FT440 monitor/totalizers
- Certified to NSF/ANSI 61 (stainless steel version)

Note: For a complete system, order flow monitor/totalizer, installation fitting, and power supply separately.

SPECIFICATIONS

ACCURACY	±1% Full Scale
FLOW VELOCITY RANGE	0.28 to 20 fps
OUTPUT	Square Wave Pulse, Opto-isolated, 550 Hz (Max)
CONDUCTIVITY	>20 µS/cm
EMPTY PIPE DETECTION	Defaults to Zero Flow
MATERIALS	Sensor: 316 Stainless Steel (SS), PVC or Brass Electrode Cap: PVDF Electrodes: Hastelloy® Housing: Cast Aluminum, Powder Coated O-ring: EPDM
MAX PRESSURE	Stainless Steel & Brass: 200 psi PVC: 150 psi
OPERATING TEMPERATURES	Stainless Steel & Brass: 32 to 200°F PVC: 32 to 130°F
POWER	12 to 25 VDC, 250 mA minimum
SENSOR CABLE	18-ft Length



INSERTION ELECTROMAGNETIC FLOW RATES

PIPE SIZE	1"	1-1/2"	2"	3"	4"	6"	8"	10"
MINIMUM FLOW (GPM)	0.69	1.5	2.7	6.2	11	25	43	68
MAXIMUM FLOW (GPM)	49	110	196	440	783	1760	3130	4900

FLOWMETERS

C&M PART #	MFG PART #	PIPE SIZE	BODY & SHAFT
401346	EX810P	1 to 3"	PVC
401347	EX810S	1 to 3"	316 SS
401348	EX810B	1 to 3"	Brass
401349	EX820S	4 to 10"	PVC
401350	EX820P	4 to 10"	316 SS
401351	EX820B	4 to 10"	Brass

INSTALLATION FITTINGS

C&M PART #	MFG PART #	FITTING TYPE	FITTING MATERIAL	PIPE SIZE
401321	EF81T-B-100	Tee	Bronze	1"
401322	EF81T-B-150	Tee	Bronze	1-1/2"
401323	EF81T-B-200	Tee	Bronze	2"
401324	EF81T-B-300	Tee	Bronze	3"
401325	EF81T-P-100	Tee	SCH 80 PVC	1"
401326	EF81T-P-150	Tee	SCH 80 PVC	1-1/2"
401327	EF81T-P-200	Tee	SCH 80 PVC	2"
401328	EF81T-S-100	Tee	304 SS	1"
401329	EF81T-S-150	Tee	304 SS	1-1/2"
401330	EF81T-S-200	Tee	304 SS	2"
401332	EF82S-F-300	Saddle	Ductile Iron	3"
401333	EF82S-F-400	Saddle	Ductile Iron	4"
401334	EF82S-F-600	Saddle	Ductile Iron	6"
401335	EF82S-F-800	Saddle	Ductile Iron	8"
401331	EF82S-F-1000	Saddle	Ductile Iron	10"

REPLACEMENT PARTS & ACCESSORIES

C&M PART #	MFG PART #	DESCRIPTION
401404	PC42	115/230 VAC Dual Power Supply (12/24 VDC output) with Power Cord

Seametrics® Battery-Powered Insertion Electromagnetic Flowmeters

Use the EX90-Series Battery-Powered Insertion Electromagnetic Flowmeters with conductive fluids in 4 to 12" pipe sizes. Powered by long lasting lithium battery pack, these flowmeters are for use in remote sites where AC power is not available. With no moving parts, these meters can be used in "dirty water" applications where debris would foul a mechanical meter. The all stainless steel body allows the meter to operate in a wide range of temperatures and pressure as well as corrosive or dirty environments.



Set the rate and total units via the front panel touch key pad. Bidirectional flow is standard with totals available in forward total, reverse total, net total, batch forward total and batch reverse total. If the EX90 meter is used with a programmable controller, the output signal can be fed direct, with no other conditioning required.

FEATURES & BENEFITS

- Use in remote sites where there is no power available
- For use with both clean or dirty water
- Ideal replacement of mechanical style propeller meters
- Lithium battery pack provides up to 4 years of battery life
- Durable stainless steel construction
- Included pipe saddle ensures correct placement in full, pressurized pipes
- No moving parts or bearings to replace, no routine maintenance

INCLUDES

20 ft power/output cable, battery pack and pipe saddle

SPECIFICATIONS

ACCURACY	±2% of Reading
FLOW VELOCITY RANGE	1.64 to 14.8 ft/sec (Low-Flow Cutoff 0.49 ft/sec)
DISPLAY	128 x 64 LCD, 5-Digit Flow Rate, 8-Digit Total Flow
RATE UNITS	Gallons, Liters, Cu Ft, Cu Meters, Million Gallons, Mega Liters, Imperial Gallons and Million Imperial Gallons per Second/Minute/Hour/Day
OUTPUT	Current Sinking Pulse, Isolated; User Scalable Pulse Rate from 0.1 to 99,999.9 Volume Units/Pulse
CONDUCTIVITY	>20 uS/cm
MATERIALS	Sensor Body & Shaft: 316 Stainless Steel Electrode Cap: PVDF Electrodes: Hastelloy® Housing: Cast Powder-Coated Aluminum O-Ring: EPDM
POWER	7.2 V 'D' Size Lithium Battery Pack, Replaceable
CABLE	20' L, for Pulse Output and Optional External Power
DIMENSIONS	5.48" Dia; 10.4 to 14.29" H (Model Specific)
ENCLOSURE RATING	IP68

CERTIFICATIONS

- NSF/ANSI 61 and NSF 372

FLOW RANGE

NOMINAL PIPE SIZE	4"	6"	8"	10"	12"
MINIMUM GPM	64.3	144.6	257	401.6	578.3
MAXIMUM GPM	578	1301	2313	3614	5204

C&M PART #	MFG PART #	SADDLE SIZE	SADDLE RANGE
401352	EX90-0400-BX-XX-0064	4"	4.00 to 4.90"
401353	EX90-0600-BX-XX-0064	6"	6.00 to 6.90"
401354	EX90-0800-BX-XX-0064	8"	8.00 to 9.05"
401355	EX90-1000-BX-XX-0064	10"	10.40 to 11.10"
401356	EX90-1200-BX-XX-0064	12"	12.10 to 13.20"

Pulsafeeder Pulse Output Water Meters

Use these Pulsafeeder MultiJet Water Meters to remotely control the dosing rate of chemical feed pumps that accept a pulse input signal. Water meters provide a pulse output signal proportional to the water flow passing through the meter. Both brass and plastic water meters can be used for potable water.



FEATURES & BENEFITS

- Changing pulse rate requires no special tools
- Calibration plug seal wire for tamper evidence
- Totalizing register

INCLUDES

Meter couplings

SPECIFICATIONS

ACCURACY	±1.5%
MAX PRESSURE (PSI)	150

C&M PART #	MFG PART #	GALLONS PER CONTACT	CONNECTION NPT(M)	MAX FLOW (GPD)
BRASS WATER METERS				
1112542401	MTR104-G	1	3/4"	20
1112542402	MTR107-G	10	3/4"	20
1112543001	MTR304-G	1	1"	50
1112543002	MTR307-G	10	1"	50
1112543003	MTR310-G	100	1"	50
1112544001	MTR404-G	1	1-1/2"	100
1112544002	MTR407-G	10	1-1/2"	100
1112544003	MTR410-G	100	1-1/2"	100
1112545001	MTR504-G	1	2"	160
1112545002	MTR507-G	10	2"	160
1112545003	MTR510-G	100	2"	160
PLASTIC WATER METERS				
1112652401	MTR104-P	1	3/4"	20
1112652402	MTR107-P	10	3/4"	20
1112653001	MTR304-P	1	1"	50
1112653002	MTR307-P	10	1"	50
1112654001	MTR404-P	1	1-1/2"	100
1112654002	MTR407-P	10	1-1/2"	100

Seametrics® Adjustable-Depth Paddlewheel Flow Sensors



The IP100/200-Series Adjustable-Depth Paddlewheel Flow Sensors are designed for use with a variety of clean liquids in 3 to 40" pipe sizes. High-quality jewel bearings and nickel-bound tungsten carbide shafts offer extreme low friction and long life.

Ruby bearings and a non-drag Hall-effect sensor give these meters the widest flow range of any paddlewheel on the market. A sensor detects the passage of miniature magnets in the six rotor blades. Send the resulting square-wave signal hundreds of feet over unshielded cable without a transmitter to a PLC or a FT-series flow monitor/totalizer. The FT-series monitors/totalizers provide digital rate and total displays, as well as a programmable pulse output; the FT440 also provides a 4 to 20 mA analog output.

Flow sensors feature 1-1/2" or 2" NPT(M) threaded fittings to thread into saddles and weld-o-lets (purchase separately). Select IP150B/250B "hot-tap" models to install or service without shutting down the line. They use a 2" NPT(M) isolation valve (included) with a nipple for installation on the pipe fitting; no special tool is required.

FEATURES & BENEFITS

- Use for clean or slightly turbid gray water applications
- One moving part
- Wide flow range
- Low friction, long-life jewel bearings

Note: For a complete system, order flow monitor/totalizer, service saddle and power supply separately.

SPECIFICATIONS

ACCURACY	±1.5% Full Scale
FLOW VELOCITY RANGE	0.3 to 30 fps
OUTPUT	Hall effect sensor, 12 VDC current sinking pulse
MATERIALS	Body: 316 Stainless-Steel, PVC or Brass Shaft: PVDF/Tungsten carbide Rotor: PVDF Housing: Cast Aluminum, Powder Coated Bearings: Ruby Jewel
MAX PRESSURE	Stainless Steel & Brass: 200 psi PVC: 150 psi
OPERATING TEMPERATURES	Stainless Steel & Brass: 32 to 200°F PVC: 32 to 130°F
POWER	VDC Powered: 6 to 40 VDC, <2 mA current draw Micro Powered: 3.5 to 16 VDC, 60 µA current draw @3.6 VDC (FT450 Li-Ion Battery)
SENSOR CABLE	18-ft Length

INSERTION PADDLEWHEEL FLOW RATES

PIPE SIZE	3"	4"	6"	8"	10"	12"	16"	24"	40"
MINIMUM FLOW (GPM)	6.6	12	27	46.8	73	106	188	422	1174
MAXIMUM FLOW (GPM)	660	1200	2700	4700	7370	10,600	18,800	42,000	117,400

C&M PART #	MFG PART #	PIPE SIZE	FITTING SIZE	BODY	USE WITH FLOW MONITOR/TOTALIZER
STANDARD FLOW SENSORS					
401362	IP110B	3 to 12"	1-1/2" NPT(M)	Brass	FT430 or FT440
401364	IP110P	3 to 12"	2" NPT(M)	PVC	FT430 or FT440
401366	IP110S	3 to 12"	1-1/2" NPT(M)	316 SS	FT430 or FT440
401369	IP210B	12 to 40"	1-1/2" NPT(M)	Brass	FT430 or FT440
401371	IP210P	12 to 40"	2" NPT(M)	PVC	FT430 or FT440
401373	IP210S	12 to 40"	1-1/2" NPT(M)	316 SS	FT430 or FT440
STANDARD HOT TAP FLOW SENSORS					
401368	IP150B	3 to 12"	2" NPT(M)	Brass	FT430 or FT440
401375	IP250B	12 to 40"	2" NPT(M)	Brass	FT430 or FT440
MICRO-POWERED FLOW SENSORS (USE WITH FT450 FLOW MONITOR/TOTALIZERS)					
401363	IP110B-04	3 to 12"	1-1/2" NPT(M)	Brass	FT450
401365	IP110P-04	3 to 12"	2" NPT(M)	PVC	FT450
401367	IP110S-04	3 to 12"	1-1/2" NPT(M)	316 SS	FT450
401370	IP210B-04	12 to 40"	1-1/2" NPT(M)	Brass	FT450
401372	IP210P-04	12 to 40"	2" NPT(M)	PVC	FT450
401374	IP210S-04	12 to 40"	1-1/2" NPT(M)	316 SS	FT450

REPLACEMENT PARTS & ACCESSORIES

C&M PART #	MFG PART #	DESCRIPTION
401404	PC42	115/230 VAC Dual Power Supply (12/24 VDC output) with Power Cord

SMITH BLAIR SERVICE SADDLES



Visit supply.coreandmain.com
for a wide selection of
Smith Blair 317 Series Service Saddles

Seametrics® Fixed-Depth Paddlewheel Flow Sensors

The IP800-Series Fixed-Depth Paddlewheel Insertion Flow Sensors are designed for use with a wide variety of clean liquids in 1/2 to 8" pipe sizes. Machined solid rod bodies provide maximum precision, while high-quality jewel bearings and nickel-bound tungsten carbide shafts offer extremely low friction and long service life.

The rotation of the rotor is detected by a nondrag Hall-effect sensor. Send current-sinking pulse output to a PLC, counter or a FT-series flow monitor/totalizer for flow rate/total display up to 2000 feet without a transmitter. Use FT430 monitor/totalizer for basic rate/total and pulse output; the FT440 monitor/totalizer also provides 4 to 20 mA output as well as display of rate and total.

These flow sensors require special fittings that ensure correct depth placement in the pipe—order separately. Fittings come in a variety of materials for compatibility with specific applications. Tee fittings are individually wet calibrated at the factory and marked with the K-factor (pulses per gallon). Saddle fittings must be field-installed on the pipe and do not come wet-calibrated. K-factors for saddles are based on factory-testing.

FEATURES & BENEFITS

- Use for clean or slightly turbid gray water applications
- One moving part
- Fixed depth in fitting ensures proper placement in pipe
- Low friction, long-life jewel bearings

Note: For a complete system, order flow monitor/totalizer, installation fitting and power supply separately.

SPECIFICATIONS

ACCURACY	±1.5% Full Scale
FLOW VELOCITY RANGE	0.3 to 30 fps
OUTPUT	Hall effect sensor, 12 VDC current sinking pulse
MATERIALS	Body: 316 Stainless Steel (SS) or PVC Shaft: Nickel Bound Tungsten Carbide Rotor: PVDF O-ring: EPDM Bearings: Ruby Jewel
MAX PRESSURE	Stainless Steel & Brass: 200 psi PVC: 150 psi
OPERATING TEMPERATURES	Stainless Steel: 32 to 200°F PVC: 32 to 130°F
POWER	VDC Powered: 6 to 40 VDC, <2 mA current draw Micro Powered: 3.5 to 16 VDC, 60 µA current draw @3.6 VDC (FT450 Li-Ion Battery)
SENSOR CABLE	18-ft Length

TEE-MOUNT PADDLEWHEEL FLOW RATES

PIPE SIZE	1/2"	3/4"	1"	1-1/2"	2"	3"	4"	6"	8"
MINIMUM FLOW (GPM)	0.28	0.5	0.8	1.9	3.1	6.9	12	27	46.8
MAXIMUM FLOW (GPM)	28	50	80	190	314	691	1190	2700	4680



Seametrics

C&M PART #	MFG PART #	PIPE SIZE	BODY	FLOW MONITOR/TOTALIZER
STANDARD FLOW SENSORS				
401376	IP810P	1/2 to 3"	PVC	FT430 & FT440
401378	IP810S	1/2 to 3"	316 SS	FT430 & FT440
401380	IP820P	4 to 8"	PVC	FT430 & FT440
401382	IP820S	4 to 8"	316 SS	FT430 & FT440
MICRO-POWERED FLOW SENSORS				
401377	IP810P-04	1/2 to 3"	PVC	FT450
401379	IP810S-04	1/2 to 3"	316 SS	FT450
401381	IP820P-04	4 to 8"	PVC	FT450
401383	IP820S-04	4 to 8"	316 SS	FT450

INSTALLATION FITTINGS

C&M PART #	MFG PART #	FITTING TYPE	FITTING MATERIAL	PIPE SIZE
401384	MF81TC-B-050	Tee	Bronze	1/2"
401385	MF81TC-B-075	Tee	Bronze	3/4"
401386	MF81TC-B-100	Tee	Bronze	1"
401387	MF81TC-B-150	Tee	Bronze	1-1/2"
401388	MF81TC-B-200	Tee	Bronze	2"
401389	MF81TC-B-300	Tee	Bronze	3"
401390	MF81T-P-050	Tee	SCH 80 PVC	1/2"
401391	MF81T-P-075	Tee	SCH 80 PVC	3/4"
401392	MF81T-P-100	Tee	SCH 80 PVC	1"
401393	MF81T-P-150	Tee	SCH 80 PVC	1-1/2"
401394	MF81T-P-200	Tee	SCH 80 PVC	2"
401395	MF81T-S-050	Tee	304 SS	1/2"
401396	MF81T-S-075	Tee	304 SS	3/4"
401397	MF81T-S-100	Tee	304 SS	1"
401398	MF81T-S-150	Tee	304 SS	1-1/2"
401399	MF81T-S-200	Tee	304 SS	2"
401400	MF82S-F-300	Saddle	Ductile Iron	3"
401401	MF82S-F-400	Saddle	Ductile Iron	4"
401402	MF82S-F-600	Saddle	Ductile Iron	6"
401403	MF82S-F-800	Saddle	Ductile Iron	8"

REPLACEMENT PARTS & ACCESSORIES

C&M PART #	MFG PART #	DESCRIPTION
401404	PC42	115/230 VAC Dual Power Supply (12/24VDC output) with Power Cord



Hach FL900 Flo-Dar Sensor Assembly with SVS

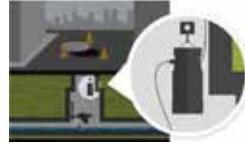

The FLO-DAR® AV Sensor offers an optimal solution for non-contact, maintenance-free monitoring of sewer flow, suitable for both portable and permanent installations.

Flo-Dar integrates Doppler Radar velocity and Ultrasonic depth sensors, making it well-suited for applications in open channel flow. Additionally, it provides the flexibility of a Portable Flo-Logger as an optional feature.

APPLICATIONS

- Wastewater
- Collection Systems
- Industrial Water

FEATURES & BENEFITS

Precise Flow Measurement - FLO-DAR delivers exceptionally accurate flow measurements across a broad spectrum of flow rates and diverse site conditions. By capturing fluid velocity from an elevated position, FLO-DAR overcomes inherent accuracy challenges associated with submerged sensors, such as sensor disturbances, high solids content, and uneven reflector distribution.

Non-Contact Sensor Ensures Data Integrity - With a non-contact sensor positioned above the flow, FLO-DAR avoids data loss and remains impervious to fouling caused by debris and grease, ensuring consistent and reliable performance.

Effortless Installation and Maintenance - Mounted above the flow, the sensor minimizes personnel interaction during installation. Furthermore, future sensor removal and replacement can be executed without the need for confined space entry.

Verified Independent Accuracy and Long-Term Stability - FLO-DAR's sensor accuracy and enduring stability, validated independently for up to three years without requiring on-site calibration, have undergone rigorous assessments. These assessments include a formal evaluation by Alden Research Laboratory, Inc., as well as recent field evaluations conducted by municipalities and consulting engineering firms.

Ideal for Challenging Flow Conditions - Capable of operating seamlessly in demanding conditions, FLO-DAR excels in scenarios involving high solids content, elevated temperatures, shallow and caustic flows, large man-made channels, and velocities reaching up to 20 ft/s.

Optional Surge Velocity Sensor (SVS) - During surcharge events, FLO-DAR's optional SVS electromagnetic sensor ensures uninterrupted and accurate flow monitoring through both dry and wet weather flows. Remarkably, routine sensor cleaning or maintenance is not required, further enhancing its reliability.

INCLUDES

Flo-Dar AV Sensor with SVS, User Manual, 12-month Warranty

SPECIFICATIONS

DIMENSIONS	10"W x 8.7"D x 16"H
WEIGHT	10 to 18 lbs.
OPERATING TEMPERATURE	0 to 140° F
POWER	8 to 18 Vdc from batteries or external power source, 2.5W max.
SENSOR PORTS	1, 2 or 4
CONNECTORS	Stainless Steel
DATALOG CHANNELS	16
ALARMS	16, including high/high, high, low, low/low and system alarms including low battery, low RTC battery, low slate memory, slate memory full, sensor timeout, sensor ID error
ALARM ACTIONS	e-mail, text message (requires wireless logger and active wireless service), trigger sampler, change logging interval, change call interval
LOGGING INTERVALS	1, 2, 3, 4, 5, 6, 10, 12, 15, 20, 30 or 60 minutes; Primary and secondary intervals for dynamic logging.
DATA STORAGE	Datalog: 325,000 sensor measurement data points; 1128 days for 3 channels at 15-minute log intervals; Event Log: 1,000 events maximum in non-volatile flash memory; Sample History: 2,000 sample events maximum in non-volatile flash memory
COMMUNICATIONS	USB; Wireless modem; 3G and 4G LTE technology with a mobile provider.
TIME-BASED ACCURACY	±0.002%, synchronized every 24 hours with server software and modem
IP RATINGS	IP68/NEMA 6P

Continued on Next Page

Hach FL900 Flo-Dar Sensor Assembly with SVS *(continued)*

CERTIFICATIONS

FLO-DAR Sensor Model Numbers: 890004801, 890004901, 890004804, 890005201, 890004807, and 890005204; **Frequency:** 24.10GHz to 24.15GHz; **Category:** Field Disturbance Sensor; **Output Field Strength:** < 2.5 V/m (128dBuV/m) @ 3m, measured per following standards, certified to FCC Part 15.245: FCC ID: VIC-FLODAR24, certified to Industry Canada Spec. RSS210. V7: IC No.: 6149A-FLODAR24

FLO-DAR Sensor Model Numbers: 890004802, 890004902, 890004805, 890005202, 890004808, and 890005205; **Frequency:** 24.16GHz to 24.19GHz; **Category:** Short Range Device **Output Power (EIRP):** < 10mW (10dBm) @ 3m, measured per the following standard Certified to ETSI EN 300 440-1 V1.6.1 (2010-08)

ORDERING INFORMATION

FL900 Series Flow Logger
FL900.97 in USA, FL900.98 in EU - FL900 Flow Logger, 1 sensor port
FL900AV.97 in USA, FL900AV.98 in EU - FL900 Flow Logger with AV9000 analyzer module, 1 sensor port

EXTERNAL MODULES

8531300 - AV9000 Area Velocity Analyzer module (required to attach a Submerged AV sensor)
8549800 - IM9001 Interface module (required to attach a Sigma 950 flow meter)

ANTENNAS*

8623800 - Blade, 3G/4G LTE, 3 dBi
8624000 - Mini-wing, 2G/3G/4G LTE, 2.5 Meter Cable, 5.5 dBi
8624200 - Burial, 3G/4G LTE, 3 Meter Cable, 3 dBi
8624400 - Manhole Lid, 3G/4G LTE, 3 Meter Cable, 3 dBi

*Wireless option only available in the USA and Canada

CABLES

8528700 - Cable, External power, 2 wire, 9 ft.
8528200 - Cable, Communication, RS232, 9 ft.
8528300 - Cable, Communication, USB, 9 ft.
9500700 - Cable, Aux, 7pin MIL 5015 (Connect to Hach AS950 Sampler*), 9 ft.
9500701 - Cable, Aux, 7pin MIL 5015 (Connect to Hach AS950 Sampler*), 25 ft.
8322800 - Cable assembly, power input Aux, AS950-FL900 with power adapter

*Cables for obsolete sampler models are also available.

SOFTWARE

FSDATA Desktop Instrument Manager Desktop free download at: www.hachflow.com

MOUNTING HARDWARE

8543800 - Wall mount bracket (304 Stainless)
8545600 - Wall mount bracket with ladder hanger (304 Stainless)
8542700 - Wall mount bracket with AC Power Supply shelf (304 Stainless)
8544500 - Wall mount bracket with AC Power Supply Shelf with ladder hanger (304 Stainless)

REPLACEMENT PARTS

8755500 - Desiccant refill beads, Bulk 1.5 lb
11013M - Battery, 6V lantern
8542900 - Battery, long-life alkaline
8542800 - Rain Gauge with 100 ft. cable

Please call Core & Main Supply at 1-888-885-2673 to talk with our Product Specialist Team about application and ordering information.

SOLUTIONS AND SUPPORT FOR LONG-TERM SUCCESS

Look to Core & Main CORE+ to assist you with solutions for Infiltration & Inflows (I&I) studies and Sanitary Sewer Overflow (SSO) issues, meter (AMR) and Advancing Metering Infrastructure (AMI), Smart Grid Integration, after sales data management and system services. No matter the size of your project, our team is committed to providing you with the most modern metering products and services, along with relevant and expert advice whenever you need it.



CORE+



Greyline TTFM 6.1 Transit Time Flowmeters

The TTFM 6.1 Transit-Time Flow Meter is well-suited for a variety of applications, including treated clean water, raw water, cooling water, chemicals, hydraulic oil, low-conductivity water, water/glycol solutions, and diesel and fuel oils. This unit operates by calculating the time-of-flight difference for ultrasonic sound pulses transmitted between two transducers. The flow meter measures the time lapse between transmitted and received signals.

Installation of the TTFM 6.1 Transit-Time Flow Meter involves mounting the ultrasonic transducers externally on a pipe. Using the convenient 5-button keypad, input relevant information such as pipe material, outer diameter, wall thickness, and fluid type. The flow meter will then provide the correct transducer separation distance and mounting method.

Achieving accurate flow rate measurements for relatively clean, non-aerated fluids in full pipes is made easy with the TTFM 6.1 Transit-Time Flow Meter. You don't need to possess expertise in non-contacting flow measurement to obtain optimal results for your specific application. Let us assist you in ensuring precise flow rate measurements for your needs.

FEATURES & BENEFITS

- Three easy-to-select transducer options covering 15 mm to 1,200 mm nominal pipe diameters
- Transducers work on all common pipe materials
- Standard mounting hardware makes novice installers look like experts
- Transducers simply strap to the outside of the pipe, meaning no wear and tear, and no shutdown to install
- Analog, pulse, and serial communication options to meet your specific application needs
- Standard 26-million-point data logger and free Logging Software make data management and reporting fast and easy
- All transducers are approved for use in hazardous locations

GENERAL SPECIFICATIONS

OPERATING PARAMETERS	For clean liquids in full pipes with less than 2% solids or gas bubbles
PROGRAMMING	Built-in, 5-button keypad with English, French, and Spanish menu language
ELECTRONICS ENCLOSURE	NEMA4X (IP66) polycarbonate with clear, shatterproof cover
FLOW VELOCITY RANGE	±0.07 ft/s to 40 ft/s
ACCURACY	±1% of reading from 1.5 ft/s to 40 ft/s; ±0.015 ft/s for velocities below 1.5 ft/s Repeatability & Linearity: ±0.25%
DISPLAY	White, backlit matrix - displays 5-digit flow rate with floating decimal, 14-digit totalizer, relay status, operating mode, and calibration menu
POWER INPUT	100-240 V AC 50/60 Hz, 10 VA maximum; Optional: 9-32 V DC, 10 W maximum
ANALOG OUTPUT	Isolated 4-20mA, 0-5 V, 1 kΩ load maximum
CONTROL RELAYS	2 Relays, form 'C' dry contacts rated 5 A SPDT; programmable flow alarm and/or flow proportional pulse; Optional: 4 additional (6 total), rated 5 A SPDT
DATA LOGGER	Built-in 128 MB data logger with a USB output and Windows software. Capacity for approximately 26 million data points
ELECTRONICS OPERATING TEMPERATURE	-5 °F to 140 °F
SHIPPING WEIGHT	12 lbs



SENSOR SPECIFICATIONS

PIPE DIAMETER (RECOMMENDED)	SE16A: 0.5 in to 1.5 in; SE16B: 2 in to 10 in; SE16C: 12 in to 48 in
PIPE DIAMETER (SUITABLE FOR)	SE16A: 0.5 in to 6 in; SE16B: 2 in to 48 in; SE16C: 4 in to 48 in
PIPE MATERIALS	Sonic conducting material-carbon steel, stainless steel, ductile iron, concrete-lined ductile iron, cast iron, PVC, HDPE, PVDF, fiberglass, copper, brass, aluminum, and pipes with bonded liners including epoxy, rubber, and Teflon
OPERATING FREQUENCY	SE16A: 2.56 MHz; SE16B: 1.28 MHz; SE16C: 640 kHz
OPERATING TEMPERATURE	-40 °F to 300 °F
TRANSDUCER MOUNTING KIT	SE16A: Includes stainless steel track with pipe clamps, built-in ruler, and coupling tape; SE16B: Includes a set of stainless-steel transducer brackets, clamps, alignment bar, and coupling tape; SE16C: Includes set of stainless-steel transducer brackets, clamps, alignment bar with a built-in ruler, and coupling tape
TRANSDUCER CABLES	Triaxial, 25 ft with BNC connectors and seal jackets; extendable up to 500 ft

CERTIFICATIONS

- Electronics - CE, CSA/EN/UL 61010-1
- Transducers - Certified Non-incendive for Class I, Div 2, Groups A, B, C, D; Optional: Certified Intrinsically safe for Class I, Div 1, Groups C, D; Class II, Groups E, F, G; Class III; Encl. Type 4; Optional: Certified Intrinsically safe for sensor mounting in ATEX.IECEx Zone 0, Ex ia IIB T4 Ga, hazardous location

C&M PART #	MFG PART #	TRANSDUCER CABLE	POWER	MODBUS RS-485
402000	TTFM 6.1 A1A1B1A1A	25-ft	100-240 VAC	No
402001	TTFM 6.1 A1A1B1B1A	50-ft	100-240 VAC	No
402002	TTFM 6.1 A1A1B1C1A	100-ft	100-240 VAC	No

REPLACEMENT PARTS & ACCESSORIES

C&M PART #	MFG PART #	DESCRIPTION	SIZE
402003	CC-SL30	Coupling Compound, Super Lube® Synthetic Grease	3.0 oz tube



Greyline DFM 6.1 Doppler Flow Meter

Accurately measuring flow within a pipe can be challenging, but the DFM 6.1 Doppler Flow Meter provides a solution. This non-contacting, clamp-on flow meter allows for effective measurement from outside the pipe. Utilizing Doppler technology, it excels as a water flow meter, particularly for challenging liquids or those with suspended solids, including wastewater, slurries, sludge, chemicals, viscous liquids, and abrasives.

Designed for pipes with an inside diameter of 12.5 mm (0.5 in) or larger, this non-invasive Doppler ultrasonic flow meter securely clamps onto the exterior of the pipe. It facilitates flow measurements without disrupting the process, making it a versatile and efficient tool for various applications.

FEATURES & BENEFITS

- Enhanced performance
- Easy to install and configure
- Non-Contacting, clamp-on, ultrasonic sensor
- Works on a large variety of pipe materials and sizes
- Large, back-lit flow rate display and totalizer
- 2 Programmable control relays

GENERAL SPECIFICATIONS

OPERATING PARAMETERS	Liquids containing suspended solids or bubbles minimum size of 100 microns, minimum concentration 75 ppm
PROGRAMMING	Built-in, 5-button keypad with English, French, and Spanish menu language
ELECTRONICS ENCLOSURE	NEMA4X (IP66) polyester with a clear polycarbonate face
ACCURACY	±2% of reading or 1.2 in/s whichever is greater. Requires solids or bubbles minimum size of 100 microns, minimum concentration 75 ppm. Repeatability: ±0.1%, Linearity ±0.5%
DISPLAY	White, backlit matrix — displays flow rate, relay states, 16-digit totalizer, operating mode, and calibration menu
POWER INPUT	100-240 V AC 50/60 Hz, 10 VA maximum; Optional: 9-32 V DC, 10 W maximum
ANALOG OUTPUT	Isolated 4-20mA (1 kΩ load maximum) or 0-5 VC (field selectable)
CONTROL RELAYS	Qty 2, rated 5 A SPDT, programmable flow alarm, and/or proportional pulse
DATA LOGGER	Built-in 26-million-point logger with USB output and Windows software
ELECTRONICS OPERATING TEMPERATURE	-10 °F to 140 °F
SHIPPING WEIGHT	14 lbs



TRANSDUCER SPECIFICATIONS

TRANSDUCER	SE4 single-head stainless steel ultrasonic with 7.6 m (25 ft) shielded cable and designed to withstand accidental submersion to 10 psi.
PIPE DIAMETER	Any pipe ID from 0.5-in to 15-ft
FLOW RATE RANGE	±0.1 ft/s to 40 ft/s
PIPE MATERIALS	Steel, stainless steel, cast iron, ductile iron, concrete-lined ductile iron, PVC, HDPE, or any contiguous pipe material that conducts sound, including lined pipes with a liner bonded to the pipe wall. Avoid pipes with loose insertion liners and pipe walls that contain air
OPERATING TEMPERATURE	-40 °F to 300 °F
TRANSDUCER MOUNTING KIT	Adjustable stainless steel mounting kit for pipes 0.5-in ID or larger.

CERTIFICATIONS

- Electronics – CE, CSA/EN/UL 61010-1
- Transducers – Certified Non-incendive for Class I, Div 2, Groups A, B, C, D; Optional: Certified Intrinsically safe for Class I, Div 1, Groups C, D; Class II, Groups E, F, G; Class III; Encl. Type 4; Optional: Certified Intrinsically safe for sensor mounting in ATEX.IECEx Zone 0, Ex ia IIB T4 Ga, hazardous location

C&M PART #	MFG PART #	POWER	MODBUS RS-485
402004	DFM 6.1A1A1A1A	100-240 VAC	No

REPLACEMENT PARTS & ACCESSORIES

C&M PART #	MFG PART #	DESCRIPTION	SIZE
402003	CC-SL30	Coupling Compound, Super Lube® Synthetic Grease	3.0 oz tube

HOW TO ORDER



ONLINE

supply.coreandmain.com



TELEPHONE

1-888-885-2673



EMAIL

support.supply@coreandmain.com

HOURS OF OPERATION: M-F; 6 A.M. to 7 P.M. CST

McCrometer Water Specialties Propeller Meters



The Water Specialties Propeller Meter is the best choice for measuring clean water flows in municipal and industrial applications. The meter is engineered to deliver superior performance, low maintenance and unsurpassed durability. Meter materials and performance meet or exceed AWWA standard C704/92.

FEATURES & BENEFITS

- Right Angled gear drive
- One piece separation and ceramic bearings
- O-ring sealed gearbox
- Totalizers standard on all meters
- Indicator-totalizer option available

SPECIFICATIONS

ACCURACY	±2% of actual flow within the range specified for each meter size
OPERATING PRESSURE	150 psi
PROCESS CONNECTIONS	Steel flanged meters (Standard AWWA Class D 150# Rating)
OUTPUTS	4-20 mA and pulse rate output transmitter options
MATERIALS	Magnets are Anticorrosive aluminized barrier coated magnets; Everlube 6155 Shielded stainless steel Interior Bearings Ceramic sleeve type Propeller Bearing Ceramic sleeve/stainless steel Propeller Spindle Injection molded thermoplastic Propeller Stainless steel Gearbox Separator Stainless steel Shafts Stainless steel Meter Head Bolts 2" - 20": Stainless steel Meter Head Cast iron or fabricated steel NSF approved; fusion bonded epoxy coated Meter Tube Fabricated steel with straightening vanes and coated, inside and out, with 12-15 mils of NSF approved, fusion bonded epoxy by the fluidized bed method.
OPERATING TEMPERATURE	140°F Max. Consult factory for special construction for higher temperatures.

Note: Standard construction will be supplied for all main line meters unless special flow range, materials, or construction are required. Contact us at 888-885-2673 for more information.

C&M PART #	MFG PART #	SIZE	FLOW (GPM) MIN/MAX/INT	LENGTH	*WEIGHT (lbs)
FLOW TOTAL ONLY PROPELLER METERS					
4020072F	MLE04A11	4"	55/500/700	18"	80
4020072G	MLE06A11	6"	120/1200/1500	22"	150
40200769	MLE08A11	8"	150/1500/2000	24"	170
40200771	MLE10A11	10"	180/2000/3000	26"	230
40200772	MLE12A11	12"	200/3000/3500	28"	288
FLOW TOTAL & FLOW RATE PROPELLER METERS					
4020082E	MLE03A12	3"	45/250/350	18"	70
4020082F	MLE04A12	4"	55/500/700	18"	80
4020082G	MLE06A12	6"	120/1200/1500	22"	150
40200869	MLE08A12	8"	150/1500/2000	24"	170
40200871	MLE10A12	10"	180/2000/3000	26"	230
40200872	MLE12A12	12"	200/3000/3500	28"	288
FLOW TOTAL & FLOW RATE W/ 4-20 MA OUTPUT PROPELLER METERS					
4020092E	MLE03A12A	3"	45/250/350	18"	70
4020092F	MLE04A12A	4"	55/500/700	18"	80
4020092G	MLE06A12A	6"	120/1200/1500	22"	150
40200969	MLE08A12A	8"	150/1500/2000	24"	170
40200971	MLE10A12A	10"	180/2000/3000	26"	230
40200972	MLE12A12A	12"	200/3000/3500	28"	288
DIGITAL RATE & TOTAL REGISTER WITH NO OUTPUT PROPELLER METERS					
4020102E	MLE03A1D	3"	45/250/350	18"	85
4020102F	MLE04A1D	4"	55/500/700	18"	122
4020102G	MLE06A1D	6"	120/1200/1500	22"	167
40201069	MLE08A1D	8"	150/1500/2000	24"	237
40201071	MLE10A1D	10"	180/2000/3000	26"	310
40201072	MLE12A1D	12"	200/3000/3500	28"	400
DIGITAL REGISTER, MA & PULSE OUTPUTS WITH 6' LENGTH CABLE PROPELLER METERS					
4020112E	MLE03A1D2-C1	3"	45/250/350	18"	85
4020112F	MLE04A1D2-C1	4"	55/500/700	18"	122
4020112G	MLE06A1D2-C1	6"	120/1200/1500	22"	167
40201169	MLE08A1D2-C1	8"	150/1500/2000	24"	237
40201171	MLE10A1D2-C1	10"	180/2000/3000	26"	310
40201172	MLE12A1D2-C1	12"	200/3000/3500	28"	400

*Shipping weights are estimated and may change due to specific order packaging

Gauges



TABLE OF CONTENTS

Standard Gauges	204
Industrial Gauges	204
Dry Process Gauges	205
Liquid Filled Process Gauges	205
Diaphragm Seal Gauges	206
Contractor Gauges	206
Gauge Accessories	206

Weksler Liquid Filled Standard Pressure Gauges

The Weksler Liquid Filled Standard Pressure Gauges absorb vibration and pressure spikes to protect internal gauge components from pressure surges, water hammer and other transient events. These pressure gauges provide dependable pressure monitoring of your water and wastewater systems at a great price.

FEATURES & BENEFITS

- Corrosion-resistant 304 stainless steel case with plastic window
- Hermetically sealed to reduce likelihood of leaks
- Dual scale dials with bar/kPa in blue (inner scale); psi in black (outer scale)
- Suitable for a broad range of industrial applications



107322SV



107335TN

SPECIFICATIONS

MOUNT POSITION	Bottom
CONNECTION SIZE	1/4" NPT(M)
CASE MATERIAL	Stainless Steel
FLUID FILL	Glycerin
ACCURACY	±3/2/3%

C&M PART #	MFG PART #	DIAL SIZE	PRESSURE RANGE (PSI)
BRONZE TUBE/BRASS SOCKET			
10732203	BY12YPC4LW	2-1/2"	0 to 15
10732205	BY12YPD4LW	2-1/2"	0 to 30
10732230	BY12YPE4LW	2-1/2"	0 to 60
10732207	BY12YPF4LW	2-1/2"	0 to 100
107322TN	BY12YPG4LW	2-1/2"	0 to 160
10732209	BY12YPH4LW	2-1/2"	0 to 200
107322SV	BY12YPJ4LW	2-1/2"	0 to 300
107329TO	BY14YCC4LW	4"	30"/0/60
10732905	BY14YPD4LW	4"	0 to 30
10732930	BY14YPE4LW	4"	0 to 60
10732907	BY14YPF4LW	4"	0 to 100
107329TN	BY14YPG4LW	4"	0 to 160
107329SV	BY14YPJ4LW	4"	0 to 300
STAINLESS STEEL TUBE AND SOCKET			
10733503	BY42YPC4LW	2-1/2"	0 to 15
10733505	BY42YPD4LW	2-1/2"	0 to 30
10733530	BY42YPE4LW	2-1/2"	0 to 60
10733507	BY42YPF4LW	2-1/2"	0 to 100
107335TN	BY42YPG4LW	2-1/2"	0 to 160
10733509	BY42YPH4LW	2-1/2"	0 to 200
107335SV	BY42YPJ4LW	2-1/2"	0 to 300

Weksler Dry Standard Gauges

FEATURES & BENEFITS

- Black finish steel case with plastic face
- Soft soldered phosphor bronze bourdon tube and brass socket
- Dual scale dials with bar/kPa in blue (inner scale); psi in black (outer scale)
- Suitable for a broad range of industrial applications



SPECIFICATIONS

DIAL SIZE	2-1/2"
MOUNT POSITION	Bottom
CONNECTION SIZE	1/4" NPT(M)
CASE MATERIAL	Steel
FLUID FILL	None
ACCURACY	±3/2/3%

C&M PART #	MFG PART #	PRESSURE RANGE (PSI)
40189403	UA25N4L	15
40189405	UA25A4L	30
40189430	UA25B4L	60
40189407	UA25B4L	100
401894TN	UA25D4L	160
40189409	UA25E4L	200
401894SV	UA25F4L	300

Weksler Industrial Pressure Gauges

Weksler Industrial Pressure Gauges are specifically designed to meet the demanding needs of water and wastewater operations. Precise and accurate pressure measurements and unparalleled durability ensure your operations run smoothly and efficiently. Weksler industrial gauges are calibrated in accordance with ASME B40.1 Grade 2A (±1%).

FEATURES & BENEFITS

- Solid front and blowout back plate meet ASME B40.1 safety requirements
- Dry gauge—no messy glycerin leaks

SPECIFICATIONS

MOUNT POSITION	Bottom
CONNECTION SIZE	1/4" NPT(M)
CASE MATERIAL	Polypropylene
WETTED MATERIAL	Bronze/Brass
FLUID FILL	None
ACCURACY	±1%



C&M PART #	MFG PART #	DIAL SIZE	PRESSURE RANGE (PSI)
10736303	BA142PC4LW	4-1/2"	0 to 15
10736305	BA142PD4LW	4-1/2"	0 to 30
10736330	BA142PE4LW	4-1/2"	0 to 60
10736307	BA142PF4LW	4-1/2"	0 to 100
107363TN	BA142PG4LW	4-1/2"	0 to 160
10736309	BA142PH4LW	4-1/2"	0 to 200
107363SV	BA142PJ4LW	4-1/2"	0 to 300

Weksler Dry Process Pressure Gauges

Meet the rigorous demands of the water and wastewater treatment process with these high-quality Weksler Dry Process Pressure Gauges. Gauges offer reliable and accurate pressure measurements while ensuring user safety with solid front safety case and blowout back.



FEATURES & BENEFITS

- Solid front safety case with blowout back
- Dry gauge—no messy glycerin leaks

SPECIFICATIONS

MOUNT POSITION	Bottom
CASE MATERIAL	Polypropylene
WETTED MATERIAL	316SS
FLUID FILL	None
ACCURACY	±1/2%

C&M PART #	MFG PART #	DIAL SIZE	PRESSURE RANGE (PSI)
1/4" NPT(M) CONNECTIONS			
10730703	AA442PC4LW	4-1/2"	0 to 15
10730705	AA442PD4LW	4-1/2"	0 to 30
10730730	AA442PE4LW	4-1/2"	0 to 60
10730707	AA442PF4LW	4-1/2"	0 to 100
107307TN	AA442PG4LW	4-1/2"	0 to 160
10730709	AA442PH4LW	4-1/2"	0 to 200
107307SV	AA442PJ4LW	4-1/2"	0 to 300
1/2" NPT(M) CONNECTIONS			
40155703	AA442PC2LW	4-1/2"	0 to 15
40155705	AA442PD2LW	4-1/2"	0 to 30
40155730	AA442PE2LW	4-1/2"	0 to 60
40155707	AA442PF2LW	4-1/2"	0 to 100
401557TN	AA442PG2LW	4-1/2"	0 to 160
40155709	AA442PH2LW	4-1/2"	0 to 200
401557SV	AA442PJ2LW	4-1/2"	0 to 300

Weksler Liquid Filled Process Pressure Gauges

Enhance your water and wastewater treatment operations with the Weksler Liquid Filled Process Pressure Gauges. These liquid-filled gauges offer enhanced durability, vibration resistance and dampening capabilities, resulting in reliable and accurate pressure measurements and enabling precise monitoring of critical water and wastewater treatment applications.



FEATURES & BENEFITS

- Liquid fill absorbs vibration and pressure spikes, reducing the possibility of gauge failure
- Solid front safety case with blowout back

SPECIFICATIONS

MOUNT POSITION	Bottom
CASE MATERIAL	Polypropylene
WETTED MATERIAL	316SS
FLUID FILL	Glycerin
ACCURACY	±1/2%

C&M PART #	MFG PART #	DIAL SIZE	PRESSURE RANGE (PSI)
1/4" NPT(M) CONNECTIONS			
10731403	AY442PC4LW	4-1/2"	0 to 15
10731405	AY442PD4LW	4-1/2"	0 to 30
10731430	AY442PE4LW	4-1/2"	0 to 60
10731407	AY442PF4LW	4-1/2"	0 to 100
107314TN	AY442PG4LW	4-1/2"	0 to 160
10731409	AY442PH4LW	4-1/2"	0 to 200
107314SV	AY442PJ4LW	4-1/2"	0 to 300
1/2" NPT(M) CONNECTIONS			
40156403	AA442PC2LW	4-1/2"	0 to 15
40156405	AA442PD2LW	4-1/2"	0 to 30
40156430	AA442PE2LW	4-1/2"	0 to 60
40156407	AY442PF2LW	4-1/2"	0 to 100
401564TN	AA442PG2LW	4-1/2"	0 to 160
40156409	AA442PH2LW	4-1/2"	0 to 200
401564SV	AA442PJ2LW	4-1/2"	0 to 300

Weksler Pressure Gauge Cocks

Weksler Pressure Gauge Cocks provide a convenient and efficient means of installing, maintaining and protecting pressure gauges in various systems. Gauge cocks are ideal for use in water and wastewater operations, where accurate pressure measurements are crucial for efficient and safe operations.



C&M PART #	MFG PART #	DESCRIPTION	CONNECTION SIZE	MATERIAL	MAX PRESSURE (PSI)
107354	A10	Tee Handle Gauge Cock	1/4" NPT(F)	Brass	125
107356	A11	Lever Handle Gauge Cock	1/4" NPT(M x F)	Brass	200
107357	A12	Lever Handle Gauge Cock	1/4" NPT(F)	Brass	200



Diaphragm Seal Gauges

Pressure gauges with diaphragm seal are ideal for use in challenging industrial applications. These versatile and reliable gauges provide accurate and dependable pressure measurements while offering protection against corrosive, viscous and contaminated media. Combination of Hastelloy® C diaphragm and dry pressure gauge allows for use in applications with strong oxidizing agents such as chlorine.



FEATURES & BENEFITS

- Eliminates potential leak path with all-welded construction
- 304 stainless steel (SS) case with 316 SS and Hastelloy C wetted parts offers durability
- Low-fill volume reduces temperature effects on instrument accuracy

SPECIFICATIONS

MOUNT POSITION	Bottom
CASE MATERIAL	304 SS
GAUGE FILL	None
SEAL FILL	Fluorolube®
PROCESS CONNECTION SIZE	1/2" NPT(F)
WETTED MATERIAL	316 SS/Hastelloy® C

C&M PART #	MFG PART #	DIAL SIZE	PRESSURE RANGE (PSI)
40140505	KC301D2530/50310HH02T	2-1/2"	0 to 30
40140530	KC301D2560/50310HH02T	2-1/2"	0 to 60
40140507	KC301D25100/50310HH02T	2-1/2"	0 to 100
401405TN	KC301D25160/50310HH02T	2-1/2"	0 to 160
40140509	KC301D25200/50310HH02T	2-1/2"	0 to 200
40141005	KC301D4030/50310HH02T	4"	0 to 30
40141030	KC301D4060/50310HH02T	4"	0 to 60
40141007	KC301D40100/50310HH02T	4"	0 to 100
401410TN	KC301D40160/50310HH02T	4"	0 to 160
40141009	KC301D40200/50310HH02T	4"	0 to 200

Weksler Contractor Pressure Gauges

Weksler Contractor Gauges are suitable for air, water, oil, gas or any medium that does not corrode copper alloys. These economical pressure gauges are ideal for general-purpose applications.

FEATURES & BENEFITS

- Corrosion-resistant stainless steel case and plastic lens
- Dry gauge—no messy glycerin leaks

SPECIFICATIONS

MOUNT POSITION	Bottom
CONNECTION SIZE	1/4" NPT(M)
CASE MATERIAL	SS
WETTED MATERIAL	Bronze/Brass
FLUID FILL	None
ACCURACY	2/1/2%



C&M PART #	MFG PART #	DIAL SIZE	PRESSURE RANGE (PSI)
10734205	EA14A	4-1/2"	0 to 30
10734230	EA14B	4-1/2"	0 to 60
10734207	EA14C	4-1/2"	0 to 100
107342TN	EA14D	4-1/2"	0 to 160
10734209	EA14E	4-1/2"	0 to 200
107342SV	EA14F	4-1/2"	0 to 300

Weksler Pressure Gauge Adjustable Snubbers



FEATURES & BENEFITS

- Offers precise pressure control and protection against pressure transients and pulsations
- An adjustable fine thread choke valve tunes out line pulsations

C&M PART #	MFG PART #	CONNECTION SIZE	MATERIAL	MAX PRESSURE (MAX PSI)
107352	MSB4	1/4" NPT(M x F)	Brass	3,000
107353	MSS4	1/4" NPT(M x F)	Stainless Steel	5,000

Weksler Pressure Gauge Filter Snubbers

FEATURES & BENEFITS

- A built-in 3/8" dia x 1/8" thick micro metallic porous stainless steel filter disc protects gauges from particulates



C&M PART #	MFG PART #	CONNECTION SIZE	MATERIAL	MAX PRESSURE (MAX PSI)
107348	BW42	1/4" NPT(M x F)	Brass	1,500
107349	SW42	1/4" NPT(M x F)	Stainless Steel	5,000



Helpful Tip: Operator Warning

Glycerin-filled pressure gauges are unsuitable for use in work environments with oxidizing agents such as chlorine. If glycerin fluid fill mixes with an oxidizing agent, a violent reaction may occur, putting employees at risk. Operators should use gauges filled with a halocarbon, Fluorolube® or a dry gauge for applications with oxidizing agents.

Hose



TABLE OF CONTENTS

Discharge Hose	208
Mill Hose	208
Suction Hose	209
Hose Kits	210
Hose Accessories	210-211
Garden Hose	211
Hose Repair	212
Hose Nozzles	213
Hose Coupling Accessories	213
Hose Couplings	214-216

Abbott Rubber PVC Water Discharge Hose



Easily transfer fluids or materials from one location to another using the flexible PVC Water Discharge Hose. Hose handles the flow of water under pressure and rolls up flat for easy storage. Use the standard hose for moderate open-end water discharge service. It is made from close woven polyester jacket impregnated with PVC. Select the heavy-duty hose for use in higher pressure, open-end applications. It is constructed from PVC blend reinforced with two spiral piles and one longitudinal synthetic cord.

FEATURES & BENEFITS

- Mildew resistant
- Use in temperatures from -5 to 170° F

C&M PART #	MFG PART #	DIAMETER	LENGTH (ft)	HOSE ENDS
A STANDARD HOSE—BLUE				
10234201BC40	1148-1500-50-NPSH	1.5"	50	M x F NPSH
10234201BC50	1148-2000-50-NPSH	2"	50	M x F NPSH
10234201BC87	1148-3000-50-NPSH	3"	50	M x F NPSH
10234201BCC1	1148-4000-50-NPSH	4"	50	M x F NPSH
10234201BC12	1148-6000-50-NPSH	6"	50	M x F NPSH
10234202BC40	1148-1500-50-CE	1.5"	50	M x F Camlock (Aluminum)
10234202BC50	1148-2000-50-CE	2"	50	M x F Camlock (Aluminum)
10234202BC87	1148-3000-50-CE	3"	50	M x F Camlock (Aluminum)
10234202BCC1	1148-4000-50-CE	4"	50	M x F Camlock (Aluminum)
10234203BC12	1148-6000-50-CE	6"	50	M x F Camlock (Aluminum)
B HEAVY-DUTY HOSE—RED				
10237201BC40	1152-1500-50-NPSH	1.5"	50	M x F NPSH
10237201BC50	1152-2000-50-NPSH	2"	50	M x F NPSH
10237201BC87	1152-3000-50-NPSH	3"	50	M x F NPSH
10237201BCC1	1152-4000-50-NPSH	4"	50	M x F NPSH
10237202BC40	1152-1500-50-CE	1.5"	50	M x F Camlock (Aluminum)
10237202BC50	1152-2000-50-CE	2"	50	M x F Camlock (Aluminum)
10237202BC87	1152-3000-50-CE	3"	50	M x F Camlock (Aluminum)
10237202BCC1	1152-4000-50-CE	4"	50	M x F Camlock (Aluminum)

Dixon Valve & Coupling Single- & Double-Jacket Mill Hose



Single- and Double-Jacket Mill Hose refers to a type of discharge hose commonly used in industrial settings, particularly in mill and manufacturing environments. It is designed to withstand rugged conditions and provide reliable water flow for fire suppression.



FEATURES & BENEFITS

- Use for discharging applications only
- Single- and double-jacket polyester outer construction
- Black PVC rubber tube construction
- Male and female, rocker lug, aluminum expansion ring coupling connections

C&M PART #	MFG PART #	DIAMETER	LENGTH (ft)	HOSE ENDS
SINGLE-JACKET MILL HOSE				
110572TD914H	M15-50RAF	1.5"	50	M x F NST Aluminum
110572TF914H	M15-50RAS	1.5"	50	M x F NPSH Aluminum
110572TF914J	M20-50RAS	2"	50	M x F NPSH Aluminum
110572TD914I	M25-50RAF	2.5"	50	M x F NST Aluminum
110572TF914I	M25-50RAS	2.5"	50	M x F NPSH Aluminum
DOUBLE-JACKET MILL HOSE				
110568TF914H	DM15-50RAS	1.5"	50	M x F NPSH Aluminum
110568TD914H	DM15-50RAF	1.5"	50	M x F NST Aluminum
110568TD914I	DM25-50RAF	2.5"	50	M x F NPSH Aluminum
110568TF914I	DM25-50RAS	2.5"	50	M x F NST Aluminum

Abbott Rubber Double Jacket Mill Hose

Double-Jacket Mill Hose provide great abrasion resistance and service pressure. Hose is constructed of black SBR age-resistant rubber tube with white double-jacket all polyester cover. It lay flat water discharge hose featuring a double jacket for greater abrasion resistance and service pressure.



FEATURES & BENEFITS

- Use for discharging applications only
- Black SBR age-resistant rubber tube with white double-jacket all polyester cover construction
- Lays flat for easy storage
- Male and female, rocker lug, aluminum expansion ring couplings

C&M PART #	MFG PART #	DIAMETER	LENGTH (ft)	HOSE ENDS
11260201BC40	1132-1500-50-NPSH-AL/RL	1.5"	50	M x F NPSH Aluminum
11260215BC40	1132-1500-50-NST-AL/RL	1.5"	50	M x F NST Aluminum
11260201BC50	1132-2000-50-NPSH-AL/RL	2"	50	M x F NPSH Aluminum
11260201BC70	1132-2500-50-NPSH-AL/RL	2.5"	50	M x F NPSH Aluminum
11260215BC50	1132-2500-50-NST-AL/RL	2.5"	50	M x F NST Aluminum
11260201BC87	1132-3000-50-NPSH-AL/RL	3"	50	M x F NPSH Aluminum
11260201BCC1	1132-4000-50-NPSH-AL/RL	4"	50	M x F NPSH Aluminum

Abbott Rubber Rubber Wire-Reinforced Suction Hose

Use this general-purpose water suction hose with Rubber Wire-Reinforcement for dewatering, construction and industrial applications. Smooth EPDM blended rubber tube, fabric plies and steel wire spiral construction provide suction service.



FEATURES & BENEFITS

- Wire reinforcement offers rigidity needed for suction applications
- Temperature range -10 to 180° F.
- 150 psi working pressure

C&M PART #	MFG PART #	DIAMETER	LENGTH (ft)	HOSE ENDS
10238101V240	1210-1500-20	1.5"	20	M x F NPSH
10238101V250	1210-2000-20	2"	20	M x F NPSH
10238101V287	1210-3000-20	3"	20	M x F NPSH
10238101V2C1	1210-4000-20	4"	20	M x F NPSH
10238103V240	1210-1500-20-CE	1.5"	20	M x F Camlock (Aluminum)
10238103V250	1210-2000-20-CE	2"	20	M x F Camlock (Aluminum)
10238103V287	1210-3000-20-CE	3"	20	M x F Camlock (Aluminum)
10238103V2C1	1210-4000-20-CE	4"	20	M x F Camlock (Aluminum)
10238102V240	1210-1500-20-CN	1.5"	20	MNPT x F Camlock
10238102V250	1210-2000-20-CN	2"	20	MNPT x F Camlock
10238102V287	1210-3000-20-CN	3"	20	MNPT x F Camlock
10238102V2C1	1210-4000-20-CN	4"	20	MNPT x F Camlock

Abbott Rubber All-Weather Suction Hose



The All-Weather Suction Hose is rated for use down to -40°F. Black 100% EPDM rubber tube reinforced with a green polyethylene plastic helix can be used at full vacuum.

FEATURES & BENEFITS

- Abrasion resistant cover
- Lightweight and flexible
- Temperature range -40 to 140° F.
- 50 psi working pressure

Abbott Rubber PVC Suction Hose

Durable PVC Suction Hose is designed for dewatering, construction and irrigation purposes. This green, flexible abrasion-resistant PVC hose has a rigid PVC reinforcement for full vacuum use.



FEATURES & BENEFITS

- Smooth bore
- Temperature range from 15 to 140° F
- 65 psi working pressure

C&M PART #	MFG PART #	DIAMETER	LENGTH (ft.)	HOSE ENDS
10239301V240	1240-1500-20	1.5"	20	M x F NPSH
10239301V250	1240-2000-20	2"	20	M x F NPSH
10239301V287	1240-3000-20	3"	20	M x F NPSH
10239301V2C1	1240-4000-20	4"	20	M x F NPSH
10239301V2I2	1240-6000-20	6"	20	M x F NPSH
10239303V240	1240-1500-20-CE	1.5"	20	M x F Camlock (Aluminum)
10239303V250	1240-2000-20-CE	2"	20	M x F Camlock (Aluminum)
10239303V287	1240-3000-20-CE	3"	20	M x F Camlock (Aluminum)
10239303V2C1	1240-4000-20-CE	4"	20	M x F Camlock (Aluminum)
10239303V2I2	1240-6000-20-CE	6"	20	M x F Camlock (Aluminum)
10239302V240	1240-1500-20-CN	1.5"	20	MNPT x F Camlock
10239302V250	1240-2000-20-CN	2"	20	MNPT x F Camlock
10239302V287	1240-3000-20-CN	3"	20	MNPT x F Camlock
10239302V2C1	1240-4000-20-CN	4"	20	MNPT x F Camlock
10239316V2I2	1240-6000-20-CN	6"	20	MNPT x F Camlock

C&M PART #	MFG PART #	DIAMETER	LENGTH (ft)	HOSE ENDS
10232401V240	1220-1500-20	1.5"	20	M x F NPSH
10232401V250	1220-2000-20	2"	20	M x F NPSH
10232401V287	1220-3000-20	3"	20	M x F NPSH
10232401V2C1	1220-4000-20	4"	20	M x F NPSH
10232403V240	1220-1500-20-CE	1.5"	20	M x F Camlock (Aluminum)
10232403V250	1220-2000-20-CE	2"	20	M x F Camlock (Aluminum)
10232403V287	1220-3000-20-CE	3"	20	M x F Camlock (Aluminum)
10232403V2C1	1220-4000-20-CE	4"	20	M x F Camlock (Aluminum)
10232402V240	1220-1500-20-CN	1.5"	20	MNPT x F Camlock
10232402V250	1220-2000-20-CN	2"	20	MNPT x F Camlock
10232402V287	1220-3000-20-CN	3"	20	MNPT x F Camlock
10232402V2C1	1220-4000-20-CN	4"	20	MNPT x F Camlock

Core & Main PVC Water Suction/ Discharge Hose Kit



These PVC Water Suction/Discharge Hose Kits ship completely packaged in a box with 20 ft of PVC suction hose, 50 ft of discharge hose, and a steel strainer. Choose from threaded fitting kits or quick coupling fitting kits for added convenience.

Note: Quick coupling suction hose is 'C' x Nipple, discharge hose is 'C' x 'E'

INCLUDES

Suction hose assembly, discharge hose assembly and steel strainer with square holes; M & F threaded fitting kits include a spanner wrench; quick coupling kits include two aluminum part "A" adapters

C&M PART #	SIZE	COUPLING TYPE
1023160140	1-1/2"	M & F Thread
1023160150	2"	M & F Thread
1023160187	3"	M & F Thread
10231601C1	4"	M & F Thread
1023200340	1-1/2"	Quick Coupling
1023200350	2"	Quick Coupling
1023200387	3"	Quick Coupling
10232003C1	4"	Quick Coupling

Tiger Tail Hose Guides



The Tiger Tail Hose Guides help guide and protect hoses when they are being pulled or dragged across rough or uneven surfaces. The hose guide consists of a flexible and durable polyethylene tube to provide a smooth and controlled path for the hose. It acts as a protective barrier, preventing abrasion and extending the lifespan of the hose. Provides maximum abrasion protection for high pressure sewer jetting hoses.

C&M PART #	MFG PART #	DESCRIPTION
112603AE50	1230-2000-3A	2" ID X 36" Crush-Proof Hose Guide with Rope
112603AE87	1230-3000-3A	3" ID X 36" Crush-Proof Hose Guide with Rope

Hose Skimmers



Use these Skimmers to extend the life of your pump by preventing large solids and debris from entering your pump. The base diameters are at least four times that of hose ID, giving the unit a large stable base.

FEATURES & BENEFITS

- Rugged all steel construction
- Ideal for shallow water applications

DIMENSIONS

3/8" opening x 2-1/2" H

C&M PART #	MFG PART #	HOSE ID	CONNECTION
A TOP-HOLE SKIMMERS			
10235840TH	SSKS-150-TH	1-1/2"	NPT(F)
10235850TH	SSKS-200-TH	2"	NPT(F)
10235887TH	SSKS-300-TH	3"	NPT(F)
B BOTTOM-HOLE SKIMMERS			
10235840BH	SSKS-150-BH	1-1/2"	NPT(F)
10235850BH	SSKS-200-BH	2"	NPT(F)
10235887BH	SSKS-300-BH	3"	NPT(F)

Hose Strainers



These Steel Suction Strainers extend the life of your trash pump by preventing large debris and solids from entering the pump.

C&M PART #	MFG PART #	HOSE ID	CONNECTION
A SQUARE-HOLE STRAINER			
10236840SO	SSHS-150	1-1/2"	NPT(F)
10236850SO	SSHS-200	2"	NPT(F)
10236887SO	SSHS-300	3"	NPT(F)
102368C1SO	SSHS-400	4"	NPT(F)
B ROUND-HOLE STRAINER			
10236440RO	SRHS-150	1-1/2"	NPT(F)
10236450RO	SRHS-200	2"	NPT(F)
10236487RO	SRHS-300	3"	NPT(F)
102364C1RO	SRHS-400	4"	NPT(F)

Foot Valve with Strainers



These foot valves with strainers hold water in the suction line between pump duty cycles to make pump priming easier.

FEATURES & BENEFITS

- Designed for water service only
- Ductile iron construction

C&M PART #	MFG PART #	HOSE ID	CONNECTION
10235040	SFV-150	1-1/2"	NPT(F)
10235050	SFV-200	2"	NPT(F)
10235087	SFV-300	3"	NPT(F)
102350C1	SFV-400	4"	NPT(F)

REPLACEMENT PARTS & ACCESSORIES

C&M PART #	MFG PART #	DESCRIPTION
10235440	FVFA20	1-1/2" Flapper Valve Assembly
10235450	FVFA25	2" Flapper Valve Assembly
10235487	FVFA35	3" Flapper Valve Assembly
102354C1	FVFA40	4" Flapper Valve Assembly

Polypropylene Safety Bump® for Cam & Groove Fittings



Safety Bumps Fittings are an alternative to the traditional cam and groove caps and plugs. They provide a comfortable handle and a "bump" that extends beyond the hose fittings and ears, protecting them from damage.

C&M PART #	MFG PART #	TYPE	SIZE
1126900A50	20SBF	Female Safety Bump	2"
1126900A87	30SBF	Female Safety Bump	3"
1126900AC1	40SBF	Female Safety Bump	4"
1126901C50	20SBM	Male Safety Bump	2"
1126901C87	30SBM	Male Safety Bump	3"
1126901CC1	40SBM	Male Safety Bump	4"

Garden Hose Assembly



This Garden Hose Assembly is built to withstand frequent use, rough handling, and exposure to various weather conditions. Reinforced rubber construction provides flexibility, strength and resistance to kinking or twisting.

C&M PART #	MFG PART #	DESCRIPTION	SIZE
112601	1114-0625-50	Commercial Rubber Water Hose Assembly	5/8" x 50-ft L

Dixon Valve & Coupling Garden Hose Assemblies



A garden hose is a flexible tube typically made of rubber, PVC (polyvinyl chloride), or a combination of materials that is used to convey water from a water source to various outdoor applications.

Garden hoses come in various lengths, typically ranging from 25 to 100 feet, allowing users to reach different areas of their task. They usually have a standard diameter of 5/8 inch or 3/4 inch.

C&M PART #	MFG PART #	DESCRIPTION	SIZE
A CONTRACTORS GARDEN HOSE			
110561	CWH50	Black Contractors Grade EPDM Water Hose, Heavy-Duty	3/4" x 50'
B STANDARD GARDEN HOSE			
110562TGA94C	SGH25	Green Rubber Vinyl Five-ply Garden Hose	5/8" x 25'
110562TGA94D	SGH50	Green Rubber Vinyl Five-ply Garden Hose	5/8" x 50'
110562TGA94E	SGH75	Green Rubber Vinyl Five-ply Garden Hose	5/8" x 75'
110562TGA94F	SGH100	Green Rubber Vinyl Five-ply Garden Hose	5/8" x 100'
C PROFESSIONAL GARDEN HOSE			
110566TGSV4D	PGH50	Black Professional Grade EPDM Water Hose, Heavy Duty	5/8" x 50'
110566TGSV4F	PGH100	Black Professional Grade EPDM Water Hose, Heavy Duty	5/8" x 100'

Quick-Release Hose Repair Clamps

A worm gear clamp, also known as a worm drive clamp or hose clamp, is a type of fastening device used to secure and seal hoses onto fittings or other connections. Clamps are constructed of 201 stainless steel for added durability. Screw design, 5/16" slotted hex head. Band width, 1/2".



C&M PART #	MFG PART #	HOSE OD RANGE
CLAMPS WITH CARBON STEEL SCREW		
110428SJB62L	LS48	1-1/2" to 3-1/2"
110428SJB62M	LS56	1" to 4"
110428SJB62N	LS72	2" to 5"
110428SJB62O	LS88	2-1/16" to 6"
110428SJB62P	LS96	3-1/2" to 6-9/16"
110428SJB62H	LS104	2-7/8" to 7"
110428SJB62I	LS128	1-3/4" to 8-9/16"
110428SJB62J	LS152	2" to 10"
110428SJB62K	LS188	2-1/16" to 12-5/16"
CLAMPS WITH 410 SS STAINLESS STEEL SCREW		
110437SKB62L	LSS48	1-1/2" to 3-1/2"
110437SKB62N	LSS72	2" to 5"
110437SKB62O	LSS88	2-1/16" to 6"
110437SKB62H	LSS104	2-7/8" to 7"
110437SKB62I	LSS128	1-3/4" to 8-9/16"
110437SKB62J	LSS188	2-1/16" to 12-5/16"
110437SKB62Q	LSS216	10-3/16" to 14"
110437SKB62R	LSS248	10-3/4" to 16"
110437SKB62S	LSS312	1-7/8" to 20"

Hose Repair Banding & Buckles

BAND-IT products consistently opt for this standard selection, providing exceptional strength, a neat aesthetic, and excellent resistance against oxidation and weathering. Chosen widely in municipal and industrial sectors, this non-magnetic material is preferred for its durability. Introducing EASY SCALE®, a patented marking on the band that simplifies the process of determining band length. This innovation eradicates unnecessary waste and intricate measuring tasks, allowing users to unroll the required length of band effortlessly and accurately for any clamp. No more reliance on guesswork!



C&M PART #	MFG PART #	DESCRIPTION
STAINLESS STEEL BANDING & BUCKLES		
1126872A	BC-205	201 Stainless Steel Banding 5/8" Wide x 100' Length
11268803	BC-255	201 Stainless Steel Buckle 5/8" Wide, 100 Pieces
BANDING TOOL		
112685	BC-001	Standard Banding Tool for 1/4" to 3/4" Banding

Stainless Steel T-Bolt Clamps

A T-bolt clamp is a type of hose clamp that is used to secure hoses and pipes in various applications. It is designed to provide a strong and secure grip on cylindrical objects, such as hoses carrying fluids, and is commonly used in automotive, industrial, and other mechanical systems.



C&M PART #	MFG PART #	HOSE OD RANGE
1126890L	TBC131	1.25" to 1.406"
1126890M	TBC150	1.34" to 1.56"
1126890N	TBC175	1.56" to 1.81"
1126890O	TBC188	1.69" to 1.94"
1126890P	TBC200	1.81" to 2.06"
1126890Q	TBC225	2.06" to 2.31"
1126890R	TBC238	2.19" to 2.50"
1126890S	TBC250	2.31" to 2.62"
1126890T	TBC263	2.37" to 2.68"
1126890U	TBC275	2.50" to 2.81"
1126890V	TBC288	2.63" to 2.94"
1126890W	TBC300	2.75" to 3.06"
1126890X	TBC312	2.88" to 3.19"
1126890Y	TBC325	3.00" to 3.31"
1126890Z	TBC350	3.25" to 3.56"
1126891A	TBC375	3.50" to 3.81"
1126891B	TBC382	3.56" to 3.87"
1126891C	TBC400	3.75" to 4.06"
1126891D	TBC425	4.00" to 4.30"
1126891E	TBC450	4.25" to 4.56"
1126891F	TBC475	4.50" to 4.81"
1126891G	TBC500	4.75" to 5.06"
1126891H	TBC525	5.00" to 5.31"
1126891I	TBC550	5.25" to 5.56"
1126891J	TBC575	5.50" to 5.81"
1126891K	TBC600	5.75" to 6.06"
1126891L	TBC625	6.00" to 6.31"
1126891M	TBC650	6.25" to 6.56"
1126891N	TBC675	6.50" to 6.81"
1126891O	TBC700	6.75" to 7.06"
1126891P	TBC750	7.25" to 7.56"

Center Punch Hose Repair Clamps



Crafted to fulfill your precise application needs, this design is employed in less demanding scenarios where the mitigation of leaks and long-term durability are not of paramount importance. The locking mechanism is achieved through the impact of a hammer, utilizing a conical punch integrated into the tool.

C&M PART #	MFG PART #	DESCRIPTION
A CENTER PUNCH BANDS		
1126862C	BCP-9	Center Punch Clamp 5/8" Wide x 2.25" ID
1126862D	BCP-10	Center Punch Clamp 5/8" Wide x 2.50" ID
1126862E	BCP-11	Center Punch Clamp 5/8" Wide x 2.75" ID
1126862F	BCP-12	Center Punch Clamp 5/8" Wide x 3.00" ID
1126862G	BCP-16	Center Punch Clamp 5/8" Wide x 4.00" ID
1126862H	BCP-20	Center Punch Clamp 5/8" Wide x 5.00" ID
1126862I	BCP-28	Center Punch Clamp 5/8" Wide x 7.00" ID
B CENTER PUNCH TOOL		
112684	BCP-P1000I	Center Punch Tool for Preformed Clamps

Dixon Valve & Coupling Hose/Spray Nozzles



Hose/Spray Nozzles attach to the end of a garden hose or other water source to control the flow and pattern of water. Select from various nozzles to meet your spraying needs.

C&M PART #	MFG PART #	DESCRIPTION	SIZE	CONNECTION*
A PISTOL-GRIP NOZZLES				
110547	CSN75	Water Nozzle with Rubber Handle Guard	3/4"	GHT
110548	SN75	Insulated Water Nozzle with Rubber Handle Guard	3/4"	GHT
B FOG NOZZLES				
110549TDST2B	HPFN150NST	High-Press Industrial Fog Nozzle, Brass	1-1/2"	NST
110549TFST2B	HPFN150	High-Press Industrial Fog Nozzle, Brass	1-1/2"	NPSH
110553	SL150	Red Polycarbonate with Bumper Fog Nozzle	1-1/2"	NPSH
C WASHDOWN NOZZLES				
110554TGST3Z	BN6	1/4" Orifice x 6" L Plain Hose Nozzle, Brass	3/4"	GHT
110554TFST3W	BN10	5/16" Orifice x 8" L Plain Hose Nozzle, Brass	1"	NPSH
110554TFST4A	BN15	1/2" Orifice x 10" L Plain Hose Nozzle, Brass	1-1/2"	NPSH
D ADJUSTABLE NOZZLES				
110557	BTN75	4" Long Twist Nozzle, Brass	3/4"	GHT
110558TGST4B	500AN4	4" Long Twist Nozzle, Brass	3/4"	GHT
110558TGST0Y	500AN7	6" Long Twist Nozzle, Brass	3/4"	GHT
110560	GNB75GHT	Green Constant Flow Nozzle with Bumper	3/4"	GHT

*GHT—garden hose thread

Abbott Rubber Adjustable Hose/Spray Nozzles



Hose/Spray Nozzles attach to the end of a garden hose or other water source to control the flow and pattern of water. Adjust sprays from straight stream to fog. Available in Lexan or brass.

C&M PART #	MFG PART #	SIZE	CONNECTION
A LEXAN HOSE/SPRAY NOZZLES			
112600TFC640	JAHN-150	1-1/2"	NPSH
112600TDC640	JAHN-150-NST	1-1/2"	NST
112600TFC650	JAHN-200	2"	NPSH
B BRASS HOSE/SPRAY NOZZLES			
112600TF1340	JAHN-150-B	1-1/2"	NPSH
112600TD1340	JAHN-150-NST-B	1-1/2"	NST
112600TG1324	JAHN-075-B	3/4"	GHT*

*GHT—garden hose thread

Hose Coupling Gaskets



The Cam & Groove Buna-N Gaskets create a tight and secure seal between the male and female camlock fittings. This helps to prevent leaks and ensures a reliable connection. The gasket is typically placed inside the groove of the female camlock fitting, and when the male camlock fitting is inserted, it compresses the gasket, creating a tight seal. Buna-N is known for its excellent resistance to oils, fuels, and chemicals, making it suitable for a wide range of industrial applications. It also has good temperature resistance and can withstand temperatures ranging from -40 to 250°F (-40 to 121°C).

C&M PART #	MFG PART #	SIZE
11259934	QRG-125	1-1/4"
11259940	QRG-150	1-1/2"
11259950	QRG-200	2"
11259970	QRG-250	2-1/2"
11259987	QRG-300	3"
112599C1	QRG-400	4"
112599I2	QRG-600	6"
112599L1	QRG-800	8"

STAY IN TOUCH



FIND US ON

Facebook, LinkedIn,
Instagram, Twitter (X), YouTube



Dixon Valve Hose Couplings

Cam and groove fittings are a type of quick-connect coupling used to quickly connect and disconnect hoses, pipes, and other fluid transfer equipment.



C&M PART #	MFG PART #	SIZE	CONFIGURATION	MATERIAL
A REDUCERS				
110325HG094I	1510DAAL	1-1/2" x 1"	F x M Reducer	Aluminum
110325HG094H	1520-DA-AL	1-1/2" x 2"	F x M Reducer	Aluminum
110325HG091Q	2015-DA-AL	2" x 1-1/2"	F x M Reducer	Aluminum
110325HG094J	2030-DA-AL	2" x 3"	F x M Reducer	Aluminum
110325HG091S	2040-DA-AL	2" x 4"	F x M Reducer	Aluminum
110325HG091T	3015-DA-AL	3" x 1-1/2"	F x M Reducer	Aluminum
110325HG091U	3020-DA-AL	3" x 2"	F x M Reducer	Aluminum
110325HG091V	3040-DA-AL	3" x 4"	F x M Reducer	Aluminum
110325HG091X	4020-DA-AL	4" x 2"	F x M Reducer	Aluminum
110325HG091Y	4025-DA-AL	4" x 2-1/2"	F x M Reducer	Aluminum
110325HG091Z	4030-DA-AL	4" x 3"	F x M Reducer	Aluminum
110325HG091W	6040-DA-AL	6" x 4"	F x M Reducer	Aluminum
COUPLERS, CAPS AND ADAPTERS				
B Part-DC				
110337SA972A	PPH100	1"	Dust Cap	Polypropylene
110337SA972B	PPH150	1-1/2"	Dust Cap	Polypropylene
110337SA972C	PPH200	2"	Dust Cap	Polypropylene
110337SA972E	PPH300	3"	Dust Cap	Polypropylene
110337SA972F	PPH400	4"	Dust Cap	Polypropylene
C Part-DP				
110342SB972A	PPP100	1"	Dust Plug	Polypropylene
110342SB972B	PPP150	1-1/2"	Dust Plug	Polypropylene
110342SB972C	PPP200	2"	Dust Plug	Polypropylene
110342SB972E	PPP300	3"	Dust Plug	Polypropylene
110342SB972F	PPP400	4"	Dust Plug	Polypropylene

C&M PART #	MFG PART #	SIZE	CONFIGURATION	MATERIAL
COUPLERS, CAPS AND ADAPTERS (CONTINUED)				
D Part-A				
110347SC972A	PPA100	1"	M Adapter x NPT(F)	Polypropylene
110347SC972B	PPA150	1-1/2"	M Adapter x NPT(F)	Polypropylene
110347SC972C	PPA200	2"	M Adapter x NPT(F)	Polypropylene
110347SC972E	PPA300	3"	M Adapter x NPT(F)	Polypropylene
110347SC972F	PPA400	4"	M Adapter x NPT(F)	Polypropylene
E Part-B				
110352SE972A	PPB100	1"	F Coupler x NPT(M)	Polypropylene
110352SE972B	PPB150	1-1/2"	F Coupler x NPT(M)	Polypropylene
110352SE972C	PPB200	2"	F Coupler x NPT(M)	Polypropylene
110352SE972E	PPB300	3"	F Coupler x NPT(M)	Polypropylene
110352SE972F	PPB400	4"	F Coupler x NPT(M)	Polypropylene
F Part-C				
110357SF972A	PPC100	1"	F Coupler x Hose Shank	Polypropylene
110357SF972B	PPC150	1-1/2"	F Coupler x Hose Shank	Polypropylene
110357SF972C	PPC200	2"	F Coupler x Hose Shank	Polypropylene
110357SF972E	PPC300	3"	F Coupler x Hose Shank	Polypropylene
110357SF972F	PPC400	4"	F Coupler x Hose Shank	Polypropylene
G Part-D				
110362SG972A	PPD100	1"	F Coupler x NPT(F)	Polypropylene
110362SG972B	PPD150	1-1/2"	F Coupler x NPT(F)	Polypropylene
110362SG972C	PPD200	2"	F Coupler x NPT(F)	Polypropylene
110362SG972E	PPD300	3"	F Coupler x NPT(F)	Polypropylene
110362SG972F	PPD400	4"	F Coupler x NPT(F)	Polypropylene
H Part-E				
110367SH972A	PPE100	1"	M Adapter x Hose Shank	Polypropylene
110367SH972B	PPE150	1-1/2"	M Adapter x Hose Shank	Polypropylene
110367SH972C	PPE200	2"	M Adapter x Hose Shank	Polypropylene
110367SH972E	PPE300	3"	M Adapter x Hose Shank	Polypropylene
110367SH972F	PPE400	4"	M Adapter x Hose Shank	Polypropylene



Continued on Next Page



Dixon Valve Hose Couplings *(continued)*

C&M PART #	MFG PART #	SIZE	CONFIGURATION	MATERIAL
COUPLERS, CAPS AND ADAPTERS (CONTINUED)				
I Part-A Domestic				
110372SC092A	100-A-AL	1"	M Adapter x NPT(F)	Aluminum
110372SC092B	150-A-AL	1-1/2"	M Adapter x NPT(F)	Aluminum
110372SC092C	200-A-AL	2"	M Adapter x NPT(F)	Aluminum
110372SC092D	250-A-AL	2-1/2"	M Adapter x NPT(F)	Aluminum
110372SC092E	300-A-AL	3"	M Adapter x NPT(F)	Aluminum
110372SC092F	400-A-AL	4"	M Adapter x NPT(F)	Aluminum
110372SC092G	600-A-AL	6"	M Adapter x NPT(F)	Aluminum
J Part-B Domestic				
110379SE092A	100-B-AL	1"	F Coupler x NPT(M)	Aluminum
110379SE092B	150-B-AL	1-1/2"	F Coupler x NPT(M)	Aluminum
110379SE092C	200-B-AL	2"	F Coupler x NPT(M)	Aluminum
110379SE092D	250-B-AL	2-1/2"	F Coupler x NPT(M)	Aluminum
110379SE092E	300-B-AL	3"	F Coupler x NPT(M)	Aluminum
110379SE092F	400-B-AL	4"	F Coupler x NPT(M)	Aluminum
110379SE092G	600-B-AL	6"	F Coupler x NPT(M)	Aluminum
K Part-C Domestic				
110386SF092A	100-C-AL	1"	F Coupler x Hose Shank	Aluminum
110386SF092B	150-C-AL	1-1/2"	F Coupler x Hose Shank	Aluminum
110386SF092C	200-C-AL	2"	F Coupler x Hose Shank	Aluminum
110386SF092D	250-C-AL	2-1/2"	F Coupler x Hose Shank	Aluminum
110386SF092E	300-C-AL	3"	F Coupler x Hose Shank	Aluminum
110386SF092F	400-C-AL	4"	F Coupler x Hose Shank	Aluminum
110386SF092G	600-C-AL	6"	F Coupler x Hose Shank	Aluminum
L Part-D Domestic				
110393SG092A	100-D-AL	1"	F Coupler x NPT(F)	Aluminum
110393SG092B	150-D-AL	1-1/2"	F Coupler x NPT(F)	Aluminum
110393SG092C	200-D-AL	2"	F Coupler x NPT(F)	Aluminum
110393SG092D	250-D-AL	2-1/2"	F Coupler x NPT(F)	Aluminum
110393SG092E	300-D-AL	3"	F Coupler x NPT(F)	Aluminum
110393SG092F	400-D-AL	4"	F Coupler x NPT(F)	Aluminum
110393SG092G	600-D-AL	6"	F Coupler x NPT(F)	Aluminum

C&M PART #	MFG PART #	SIZE	CONFIGURATION	MATERIAL
COUPLERS, CAPS AND ADAPTERS (CONTINUED)				
M Part-E Domestic				
110400SH092A	100-E-AL	1"	M Adapter x Hose Shank	Aluminum
110400SH092B	150-E-AL	1-1/2"	M Adapter x Hose Shank	Aluminum
110400SH092C	200-E-AL	2"	M Adapter x Hose Shank	Aluminum
110400SH092D	250-E-AL	2-1/2"	M Adapter x Hose Shank	Aluminum
110400SH092E	300-E-AL	3"	M Adapter x Hose Shank	Aluminum
110400SH092F	400-E-AL	4"	M Adapter x Hose Shank	Aluminum
110400SH092G	600-E-AL	6"	M Adapter x Hose Shank	Aluminum
N Part-F Domestic				
110407SI092A	100-F-AL	1"	M Adapter x NPT(M)	Aluminum
110407SI092B	150-F-AL	1-1/2"	M Adapter x NPT(M)	Aluminum
110407SI092C	200-F-AL	2"	M Adapter x NPT(M)	Aluminum
110407SI092D	250-F-AL	2-1/2"	M Adapter x NPT(M)	Aluminum
110407SI092E	300-F-AL	3"	M Adapter x NPT(M)	Aluminum
110407SI092F	400-F-AL	4"	M Adapter x NPT(M)	Aluminum
110407SI092G	600-F-AL	6"	M Adapter x NPT(M)	Aluminum
O Part-DC Domestic				
110414SA092A	100-DC-AL	1"	Dust Cap	Aluminum
110414SA092B	150-DC-AL	1-1/2"	Dust Cap	Aluminum
110414SA092C	200-DC-AL	2"	Dust Cap	Aluminum
110414SA092D	250-DC-AL	2-1/2"	Dust Cap	Aluminum
110414SA092E	300-DC-AL	3"	Dust Cap	Aluminum
110414SA092F	400-DC-AL	4"	Dust Cap	Aluminum
110414SA092G	600-DC-AL	6"	Dust Cap	Aluminum
P Part-DP Domestic				
110421SB092A	100-DP-AL	1"	Dust Plug	Aluminum
110421SB092B	150-DP-AL	1-1/2"	Dust Plug	Aluminum
110421SB092C	200-DP-AL	2"	Dust Plug	Aluminum
110421SB092D	250-DP-AL	2-1/2"	Dust Plug	Aluminum
110421SB092E	300-DP-AL	3"	Dust Plug	Aluminum
110421SB092F	400-DP-AL	4"	Dust Plug	Aluminum
110421SB092G	600-DP-AL	6"	Dust Plug	Aluminum



Aluminum Hose Couplings

Cam and groove fittings are a type of quick-connect coupling used to quickly connect and disconnect hoses, pipes and other fluid transfer equipment. Imported.



C&M PART #	MFG PART #	SIZE	CONFIGURATION	MATERIAL
A PART-A				
102405	QA-150-DC	1-1/2"	M Adapter x NPT(F)	Aluminum
102406	QA-200-DC	2"	M Adapter x NPT(F)	Aluminum
102407	QA-300-DC	3"	M Adapter x NPT(F)	Aluminum
102408	QA-400-DC	4"	M Adapter x NPT(F)	Aluminum
B PART-B				
112598SE34	QB-125-DC	1-1/4"	F Coupler x NPT(M)	Aluminum
112598SE40	QB-150-DC	1-1/2"	F Coupler x NPT(M)	Aluminum
112598SE50	QB-200-DC	2"	F Coupler x NPT(M)	Aluminum
112598SE70	QB-250-DC	2-1/2"	F Coupler x NPT(M)	Aluminum
112598SE87	QB-300-DC	3"	F Coupler x NPT(M)	Aluminum
112598SEC1	QB-400-DC	4"	F Coupler x NPT(M)	Aluminum
112598SEI2	QB-600-DC	6"	F Coupler x NPT(M)	Aluminum
112598SEL1	QB-800-DC	8"	F Coupler x NPT(M)	Aluminum
C PART-C				
112598SF34	QC-125-DC	1-1/4"	F Coupler x Hose Shank	Aluminum
112598SF40	QC-150-DC	1-1/2"	F Coupler x Hose Shank	Aluminum
112598SF50	QC-200-DC	2"	F Coupler x Hose Shank	Aluminum
112598SF70	QC-250-DC	2-1/2"	F Coupler x Hose Shank	Aluminum
112598SF87	QC-300-DC	3"	F Coupler x Hose Shank	Aluminum
112598SFC1	QC-400-DC	4"	F Coupler x Hose Shank	Aluminum
112598SFI2	QC-600-DC	6"	F Coupler x Hose Shank	Aluminum
112598SFL1	QC-800-DC	8"	F Coupler x Hose Shank	Aluminum
D PART-D				
112598SG34	QD-125-DC	1-1/4"	F Coupler x NPT(F)	Aluminum
112598SG40	QD-150-DC	1-1/2"	F Coupler x NPT(F)	Aluminum
112598SG50	QD-200-DC	2"	F Coupler x NPT(F)	Aluminum
112598SG70	QD-250-DC	2-1/2"	F Coupler x NPT(F)	Aluminum
112598SG87	QD-300-DC	3"	F Coupler x NPT(F)	Aluminum
112598SGC1	QD-400-DC	4"	F Coupler x NPT(F)	Aluminum
112598SGI2	QD-600-DC	6"	F Coupler x NPT(F)	Aluminum
112598SGL1	QD-800-DC	8"	F Coupler x NPT(F)	Aluminum

C&M PART #	MFG PART #	SIZE	CONFIGURATION	MATERIAL
E PART-E				
112598SH34	QE-125-DC	1-1/4"	M Adapter x Hose Shank	Aluminum
112598SH40	QE-150-DC	1-1/2"	M Adapter x Hose Shank	Aluminum
112598SH50	QE-200-DC	2"	M Adapter x Hose Shank	Aluminum
112598SH70	QE-250-DC	2-1/2"	M Adapter x Hose Shank	Aluminum
112598SH87	QE-300-DC	3"	M Adapter x Hose Shank	Aluminum
112598SHC1	QE-400-DC	4"	M Adapter x Hose Shank	Aluminum
112598SHI2	QE-600-DC	6"	M Adapter x Hose Shank	Aluminum
112598SHL1	QE-800-DC	8"	M Adapter x Hose Shank	Aluminum
F PART-F				
102409	QF-150-DC	1-1/2"	M Adapter x NPT(M)	Aluminum
102410	QF-200-DC	2"	M Adapter x NPT(M)	Aluminum
102411	QF-300-DC	3"	M Adapter x NPT(M)	Aluminum
102412	QF-400-DC	4"	M Adapter x NPT(M)	Aluminum
G PART-DC				
112598SA34	QDC-125-DC	1-1/4"	Dust Cap	Aluminum
112598SA40	QDC-150-DC	1-1/2"	Dust Cap	Aluminum
112598SA50	QDC-200-DC	2"	Dust Cap	Aluminum
112598SA70	QDC-250-DC	2-1/2"	Dust Cap	Aluminum
112598SA87	QDC-300-DC	3"	Dust Cap	Aluminum
112598SAC1	QDC-400-DC	4"	Dust Cap	Aluminum
112598SAI2	QDC-600-DC	6"	Dust Cap	Aluminum
112598SAL1	QDC-800-DC	8"	Dust Cap	Aluminum
H PART-DP				
112598SB34	QDP-125-DC	1-1/4"	Dust Plug	Aluminum
112598SB40	QDP-150-DC	1-1/2"	Dust Plug	Aluminum
112598SB50	QDP-200-DC	2"	Dust Plug	Aluminum
112598SB70	QDP-250-DC	2-1/2"	Dust Plug	Aluminum
112598SB87	QDP-300-DC	3"	Dust Plug	Aluminum
112598SBC1	QDP-400-DC	4"	Dust Plug	Aluminum
112598SBI2	QDP-600-DC	6"	Dust Plug	Aluminum
112598SBL1	QDP-800-DC	8"	Dust Plug	Aluminum



Level & Pressure



TABLE OF CONTENTS

Float Switches	218-223
Float Switch Accessories	224
Junction Boxes	224
High Level Alarms	225
Submersible Transmitters	226-228
Submersible Transmitter Accessories	228
Lift Station Monitors	229
Electrical	229-230
Pump Control Panels	231-232
Pressure Switches	233
Pressure Transmitters	233-236
Ground Water Monitoring	237-242

Conery Control & Pump-Duty Mechanical Float Switches



Achieve accurate liquid level control with these Mechanical-Control & Pump-Duty Float Switches. Pear shaped bulbs help shed fats, oil and grease accumulation, making it ideal for sewage and wastewater lift station applications. The durable outer shell construction and foam filled interior provides for leak-proof operation and tremendous impact resistance.

Color coding provides easy identification—green bulb for normally open (N/O) switch, green/red bulb for normally closed (N/C) switch, green/blue bulb for single pole, double throw (can be wired as N/O or N/C) switch.

FEATURES & BENEFITS

- Durable polypropylene shell with solid polyurethane foam filling
- Pear shaped bulb designed to assist in shedding fats, oil and grease accumulation
- Mechanically activated micro switch
- Non-mercury design

INCLUDES

Externally weighted float switches include a zinc plated, cast-iron adjustable weight

SPECIFICATIONS

TYPE	Select from Signal/Control Duty, Narrow Angle; Pump Duty, Wide Angle
ELECTRICAL RATING	120 VAC, 10 A; 240 VAC, 3 A
SWITCH ELEMENT	Mechanical
ACTUATION ANGLE	5° Above, 5° Below Horizontal
DIMENSIONS	3.5" Dia x 5.0" L
FLOAT MATERIAL	Polypropylene

CERTIFICATIONS

- UL Listed

C&M PART #	MFG PART #	SWITCH TYPE	PIGGYBACK PLUG (120 VAC)	MOUNTING	CABLE LENGTH (ft)
SIGNAL/CONTROL-DUTY, NARROW-ANGLE FLOAT SWITCHES					
1046682307NO	2900-B8S1C1K1-20'	Normally Open	No	Externally Weighted	20
1046682707NO	2900-B8S1C1K1-30'	Normally Open	No	Externally Weighted	30
1046683107NO	2900-B8S1C1K1-50'	Normally Open	No	Externally Weighted	50
1046682307NC	2901-B8S1C1K1-20'	Normally Closed	No	Externally Weighted	20
1046682707NC	2901-B8S1C1K1-30'	Normally Closed	No	Externally Weighted	30
1046683107NC	2901-B8S1C1K1-50'	Normally Closed	No	Externally Weighted	50
1046682307SD	2902-B8S2C1K1-20'	SPDT	No	Externally Weighted	20
1046682707SD	2902-B8S2C1K1-30'	SPDT	No	Externally Weighted	30
1046683107SD	2902-B8S2C1K1-50'	SPDT	No	Externally Weighted	50
PUMP-DUTY, WIDE-ANGLE FLOAT SWITCHES					
1046921910NO	2900-B8S4PIC3K1-10'	Normally Open	Yes	Pipe Clamp	10
1046922310NO	2900-B8S4PIC3K1-20'	Normally Open	Yes	Pipe Clamp	20
1046922710NO	2900-B8S4PIC3K1-30'	Normally Open	Yes	Pipe Clamp	30
1046922310NC	2901-B8S4PIC3K1-20'	Normally Closed	Yes	Pipe Clamp	20

SJE MegaMaster Signal Duty Float Switches

These mechanically activated MegaMaster Narrow-Angle, Internally Weighted Float Switches are designed for level control in municipal sewage pumping stations. The internal switching mechanism contains unique gold cross-point contacts, providing precision and reliable control signals up to 1 amp. Wire the control switches to work in either normally open or normally closed applications.



FEATURES & BENEFITS

- Internally weighted
- Large twin wall tear drop shape design offers increased buoyancy
- Two-color housing allows for easy identification of float position
- Excellent solution for lift stations with high grease content
- Not sensitive to rotation

SPECIFICATIONS

TYPE	Signal/Control Duty, Narrow Angle
ELECTRICAL RATING	125 VAC, 1 A
SWITCH ELEMENT	Mechanical, SPDT, 3-Wire
ACTUATION ANGLE	10° Above/Below Horizontal
DIMENSIONS	4.03" Dia x 6.62" L
MAX OPERATING DEPTH (ft)	30
FLOAT MATERIAL	Polypropylene

CERTIFICATIONS

- CSA

C&M PART #	MFG PART #	SWITCH TYPE	MOUNTING	CABLE LENGTH (ft)
400281	1046500	NO/NC	Suspended, Internally Weighted	25
400282	1046501	NO/NC	Suspended, Internally Weighted	50
400283	1046502	NO/NC	Suspended, Internally Weighted	75
400284	1046503	NO/NC	Suspended, Internally Weighted	100

Conery Control & Pump-Duty Mercury Float Switches



These Mercury-Control and Pump-Duty Float Switches are designed for accurate liquid level control in many applications, including sewage and wastewater lift station applications. Pear shaped bulbs help shed fats, oil and grease accumulation. The durable construction provides for leak-proof operation and tremendous impact resistance. Color coding provides easy identification—yellow bulb for normally open switch, red bulb for normally closed switch and blue bulb for single pole, double throw switch (can be wired as N/O or N/C) switch.

FEATURES & BENEFITS

- Pear shaped bulb designed to assist in shedding fats, oil and grease accumulation
- Rugged polypropylene shell with polyurethane foam fill
- 1.52 g mercury tilt switch

INCLUDES

Externally weighted float switches include a zinc plated, cast-iron adjustable weight; Pipe mount float switches include stainless steel pipe clamp

Note: These items may be restricted from sale in certain states due to the mercury content. Please ensure your compliance with all laws and regulations.

SPECIFICATIONS

TYPE	Select from Signal/Control Duty, Narrow Angle; Pump Duty, Wide Angle
ELECTRICAL RATING	Signal/Control Duty, 120 VAC, 10 A; 240 VAC, 3 A; Pump Duty, 120/240 VAC, 13 A
SWITCH ELEMENT	Mercury, 1.52 g, Hermetically Sealed Capsule
ACTUATION ANGLE	5° Above, 5° Below Horizontal
DIMENSIONS	3.5" Dia x 5.0" L
FLOAT MATERIAL	Polypropylene

CERTIFICATIONS

- UL Listed

C&M PART #	MFG PART #	SWITCH TYPE	PIGGYBACK PLUG (120VAC)	MOUNTING	CABLE LENGTH (ft)
SIGNAL/CONTROL-DUTY, MERCURY, NARROW ANGLE FLOAT SWITCHES					
1046502302NO	2900-BIS1C1K1-20'	Normally Open	No	Externally Weighted	20
1046502702NO	2900-BIS1C1K1-30'	Normally Open	No	Externally Weighted	30
1046503102NO	2900-BIS1C1K1-50'	Normally Open	No	Externally Weighted	50
1046502302NC	2901-BIS1C1K1-20'	Normally Closed	No	Externally Weighted	20
1046502702NC	2901-BIS1C1K1-30'	Normally Closed	No	Externally Weighted	30
1046503102NC	2901-BIS1C1K1-50'	Normally Closed	No	Externally Weighted	50
1046502302SD	2902-BIS2C1K1-20'	SPDT	No	Externally Weighted	20
1046502702SD	2902-BIS2C1K1-30'	SPDT	No	Externally Weighted	30
1046503102SD	2902-BIS2C1K1-50'	SPDT	No	Externally Weighted	50
PUMP-DUTY, MERCURY, WIDE ANGLE FLOAT SWITCHES					
1046861905NO	2900-BIS4PIC3K1-10'	Normally Open	Yes	Pipe Mount	10
1046862305NO	2900-BIS4PIC3K1-20'	Normally Open	Yes	Pipe Mount	20
1046862305NC	2901-BIS4PIC3K1-20'	Normally Closed	Yes	Pipe Mount	20

CHECK US OUT ONLINE

We're always adding new products. Visit supply.coreandmain.com for our latest additions.

SUGGESTED PRODUCTS

Core & Main Pure Lift Station Degreaser, 100% d-Limonene

Distributed by

FEATURES & BENEFITS

- Contains 100% natural d-Limonene to dissolve greases and deposits
- Color indication lets you know when more is needed

C&M PART #	PACKAGE SIZE	QUANTITY
105040	1 Gallon Bottle	Pack of 4
105041	5 Gallon Pail	1 Each

Conery Dura-Float Control & Pump-Duty Mercury Float Switches

Use the Dura-Float Mercury-Control & Pump-Duty Float Switches for accurate liquid level control in many applications, including sewage and wastewater lift station applications. The durable construction provides for leak-proof operation and tremendous impact resistance.

CERTIFICATIONS

- UL Listed



FEATURES & BENEFITS

- Heavy-duty construction for the toughest application
- Internally weighted Dura-float design
- Rugged polypropylene shell with polyurethane foam fill
- 1.52 g mercury tilt switch

Note: These items may be restricted from sale in certain states due to the mercury content. Please ensure you comply with all laws and regulations. Please check for compliance with local electrical codes before using on 240 VAC applications.

SPECIFICATIONS

TYPE	Select from Signal/Control Duty, Narrow Angle; Pump Duty, Wide Angle
ELECTRICAL RATING	120 VAC, 10 A; 240 VAC, 3 A
SWITCH ELEMENT	Mercury, 1.52 g, Hermetically Sealed Capsule
ACTUATION ANGLE	5° Above, 5° Below Horizontal
DIMENSIONS	4.25" Dia x 6" L
FLOAT MATERIAL	Polypropylene

C&M PART #	MFG PART #	SWITCH TYPE	PIGGYBACK PLUG (120VAC)	MOUNTING	CABLE LENGTH (ft)
SIGNAL/CONTROL-DUTY, NARROW ANGLE FLOAT SWITCHES					
1046591901NO	2900-B4S1K1-10'	Normally Open	No	Internally Weighted	10
1046592301NO	2900-B4S1K1-20'	Normally Open	No	Internally Weighted	20
1046592701NO	2900-B4S1K1-30'	Normally Open	No	Internally Weighted	30
1046593101NO	2900-B4S1K1-50'	Normally Open	No	Internally Weighted	50
1046592301NC	2901-B4S1K1-20'	Normally Closed	No	Internally Weighted	20
1046592702NC	2901-B4S1K1-30'	Normally Closed	No	Internally Weighted	30
1046592701NC	2901-B4S1K1-50'	Normally Closed	No	Internally Weighted	50
1046592301SD	2902-B4S2K1-20'	SPDT	No	Internally Weighted	20
1046592701SD	2902-B4S2K1-30'	SPDT	No	Internally Weighted	30
1046590901SD	2902-B4S2K1-40'	SPDT	No	Internally Weighted	40
1046593101SD	2902-B4S2K1-50'	SPDT	No	Internally Weighted	50
PUMP-DUTY, WIDE ANGLE FLOAT SWITCHES					
1046891903NO	2900-B4S4PIK1-10'	Normally Open	Yes	Internally Weighted	10
1046892303NO	2900-B4S4PIK1-20'	Normally Open	Yes	Internally Weighted	20
1046892303NC	2901-B4S4PIK1-20'	Normally Closed	Yes	Internally Weighted	20

Conery Dura-Float Signal & Pump-Duty Mechanical Float Switches

Use the Dura-Float Signal & Pump-Duty Float Switches for accurate liquid level control in many applications, including sewage and wastewater lift station applications. The durable construction provides for leak-proof operation and tremendous impact resistance.

CERTIFICATIONS

- UL Listed



FEATURES & BENEFITS

- Heavy-duty construction for the toughest application
- Internally weighted Dura-float design
- Rugged polypropylene shell with polyurethane foam fill

Note: Ensure you are complying with local electrical codes before using on 240 VAC applications.

SPECIFICATIONS

TYPE	Select from Signal/Control Duty, from Narrow and Wide Angle; Pump Duty, Wide Angle
ELECTRICAL RATING	120 VAC, 10 A; 240 VAC, 3 A
SWITCH ELEMENT	Mechanical
ACTUATION ANGLE	10° Above, 5° Below Horizontal
DIMENSIONS	4.25" Dia x 6" L
FLOAT MATERIAL	Polypropylene

C&M PART #	MFG PART #	SWITCH TYPE	PIGGYBACK PLUG (120 VAC)	MOUNTING	CABLE LENGTH (ft)
DURA-FLOAT NARROW-ANGLE, SIGNAL/CONTROL-DUTY FLOAT SWITCHES					
1046772306NO	2900-B6S1K1-20'	Normally Open	No	Internally Weighted	20
1046772706NO	2900-B6S1K1-30'	Normally Open	No	Internally Weighted	30
1046773106NO	2900-B6S1K1-50'	Normally Open	No	Internally Weighted	50
1046772306NC	2901-B6S1K1-20'	Normally Closed	No	Internally Weighted	20
1046772706NC	2901-B6S1K1-30'	Normally Closed	No	Internally Weighted	30
1046773106NC	2901-B6S1K1-50'	Normally Closed	No	Internally Weighted	50
1046772306SD	2902-B6S2K1-20'	SPDT	No	Internally Weighted	20
1046772706SD	2902-B6S2K1-30'	SPDT	No	Internally Weighted	30
1046773106SD	2902-B6S2K1-50'	SPDT	No	Internally Weighted	50
DURA-FLOAT, WIDE-ANGLE, PUMP-DUTY FLOAT SWITCHES					
1046961908NO	2900-B6S4PIK1-10'	Normally Open	Yes	Internally Weighted	10
1046962308NO	2900-B6S4PIK1-20'	Normally Open	Yes	Internally Weighted	20
1046962308NC	2901-B6S4PIK1-20'	Normally Closed	Yes	Internally Weighted	20

SJE MilliAmpMaster™ Float Switches

The mechanically activated MilliAmpMaster Narrow-Angle Float Switches offer reliable low-current control for use with low-voltage devices such as PLC or SCADA input modules and auto dialers. These switches activate/deactivate at approximately 1.5" (3.8 cm) above and below horizontal with a 3.5" (9 cm) tether. Blue colored cap easily identifies SJE MilliAmpMaster control switches. High-impact, corrosion-resistant, polypropylene float housing ensure long service life.



FEATURES & BENEFITS

- Not sensitive to rotation
- Designed for low-current, non-arcing applications
- Mechanically activated, snap action contacts

Note: Use for low current, signal/control duty only. Externally weighted floats include weight.

SPECIFICATIONS

TYPE	Signal/Control-Duty, Narrow Angle
ELECTRICAL RATING	125 VAC, 1 Amp; 30 VDC, 0.1 Amp; 5 VDC, 1 mA
SWITCH ELEMENT	Mechanical
DIMENSIONS	2.74" Dia x 4.83" L
MAX OPERATING DEPTH (ft)	30
FLOAT MATERIAL	Polypropylene

CERTIFICATIONS

- UL, CSA

C&M PART #	MFG PART #	SWITCH TYPE	MOUNTING	CABLE LENGTH (ft)
40030908NO	1018842	Normally Open	Pipe Clamp	15
40030923NO	1018846	Normally Open	Pipe Clamp	20
40030927NO	1018850	Normally Open	Pipe Clamp	30
40030923NC	1018847	Normally Closed	Pipe Clamp	20
40030927NC	1018851	Normally Closed	Pipe Clamp	30
40031408NO	1018844	Normally Open	Externally Weighted	15
40031423NO	1018848	Normally Open	Externally Weighted	20
40031427NO	1018852	Normally Open	Externally Weighted	30
40031423NC	1018849	Normally Closed	Externally Weighted	20
40031427NC	1018853	Normally Closed	Externally Weighted	30



Helpful Tip: Preventative Maintenance

Many Wastewater Municipalities, as part of their Sanitary Sewer System CMOM Program, perform preventative maintenance, cleaning, and inspection of their Lift Station Float Switches on a quarterly basis. Look to Core & Main as your source for a complete selection of products to help you maintain proper operation of your Lift Stations.

SJE SignalMaster® Signal-Duty Float Switches

The mechanically activated SignalMaster Narrow-Angle Float Switches accurately monitor liquid levels and activate control panels and alarms in water and sewage applications. These switches control differential of 1.5" (4 cm) above or below horizontal. Colored caps make it easy to identify the switch type—yellow caps on normally open models, white caps on normally closed models.



FEATURES & BENEFITS

- High-impact, corrosion-resistant, polypropylene float housing provide long service life
- Not sensitive to rotation
- Mechanically activated, snap action contacts

Note: For signal/control duty use only, NOT for direct pump operation. Externally weighted floats include external float weight (PVC housing with adjustable clip).

SPECIFICATIONS

TYPE	Signal/Control Duty, Narrow Angle
ELECTRICAL RATING	125/250 VAC, 5 A
SWITCH ELEMENT	Mechanical
ACTUATION ANGLE	1.5" Above/Below Horizontal
DIMENSIONS	2.74" Dia x 4.83" L
MAX OPERATING DEPTH (ft)	30
FLOAT MATERIAL	Polypropylene

CERTIFICATIONS

- UL, CSA

C&M PART #	MFG PART #	SWITCH TYPE	MOUNTING	CABLE LENGTH (ft)
40029319NO	1006042	Normally Open	Pipe Clamp	10
40029308NO	1006043	Normally Open	Pipe Clamp	15
40029323NO	1006044	Normally Open	Pipe Clamp	20
40029327NO	1006045	Normally Open	Pipe Clamp	30
40029319NC	1006046	Normally Closed	Pipe Clamp	10
40029308NC	1006047	Normally Closed	Pipe Clamp	15
40029323NC	1006048	Normally Closed	Pipe Clamp	20
40029327NC	1006049	Normally Closed	Pipe Clamp	30
40030119NO	1006050	Normally Open	Externally Weighted	10
40030108NO	1006051	Normally Open	Externally Weighted	15
40030123NO	1006052	Normally Open	Externally Weighted	20
40030127NO	1006053	Normally Open	Externally Weighted	30
40030119NC	1006054	Normally Closed	Externally Weighted	10
40030108NC	1006055	Normally Closed	Externally Weighted	15
40030123NC	1006056	Normally Closed	Externally Weighted	20
40030127NC	1006057	Normally Closed	Externally Weighted	30

SJE MegaMaster Signal Duty Float Switches

These mechanically activated MegaMaster Narrow-Angle, Internally Weighted Float Switches are designed for level control in municipal sewage pumping stations. The internal switching mechanism contains unique gold cross-point contacts, providing precision and reliable control signals up to 1 amp. Wire the control switches to work in either normally open or normally closed applications.



SPECIFICATIONS

TYPE	Signal/Control Duty, Narrow Angle
ELECTRICAL RATING	125 VAC, 1 A
SWITCH ELEMENT	Mechanical, SPDT, 3-Wire
ACTUATION ANGLE	10° Above/Below Horizontal
DIMENSIONS	4.03" Dia x 6.62" L
MAX OPERATING DEPTH (ft)	30
FLOAT MATERIAL	Polypropylene

CERTIFICATIONS

- CSA

FEATURES & BENEFITS

- Internally weighted
- Large twin wall tear drop shape design offers increased buoyancy
- Two-color housing allows for easy identification of float position
- Excellent solution for lift stations with high grease content
- Not sensitive to rotation

C&M PART #	MFG PART #	SWITCH TYPE	MOUNTING	CABLE LENGTH (ft)
400281	1046500	NO/NC	Suspended, Internally Weighted	25
400282	1046501	NO/NC	Suspended, Internally Weighted	50
400283	1046502	NO/NC	Suspended, Internally Weighted	75
400284	1046503	NO/NC	Suspended, Internally Weighted	100

SJE PumpMaster® Plus Pump-Duty Float Switches

The mechanically activated PumpMaster Plus Wide-Angle Pump Switches are designed for direct control of 3/4 HP @ 120 VAC or 2 HP @ 230 VAC pumps in water and sewage applications. The pump switches are not sensitive to rotation or turbulence allowing it to be used in both calm and turbulent applications.

CERTIFICATIONS

- UL, CSA

FEATURES & BENEFITS

- Heavy-duty contacts
- Includes standard pipe mounting clamp
- Adjustable pumping range of 7 to 36"
- High-impact, corrosion-resistant float switches provide long service life

Note: Removing piggyback plug with models equipped with them negates UL/CSA approval. These switches must be used with pumps that provide integral thermal overload protection. These pump switches are designed for single-phase, horsepower rated loads and are not suitable for control/signal-duty applications (they will fail prematurely when switching loads less than 1 A at 120 VAC). Select a float switch designed for use for control/signal duty in this instance.



C&M PART #	MFG PART #	SWITCH TYPE	PIGGYBACK PLUG	PLUG VOLTAGE RATING (VAC)	MOUNTING	CABLE LENGTH (ft)
40025119NOOZ	1003232	Normally Open	Yes	120	Pipe Clamp	10
40025119NOPA	1003233	Normally Open	Yes	230	Pipe Clamp	10
40025108NOOZ	1003243	Normally Open	Yes	120	Pipe Clamp	15
40025108NOPA	1003245	Normally Open	Yes	230	Pipe Clamp	15
40025123NOOZ	1003255	Normally Open	Yes	120	Pipe Clamp	20
40025123NOPA	1003257	Normally Open	Yes	230	Pipe Clamp	20
40025127NOOZ	1003267	Normally Open	Yes	120	Pipe Clamp	30
40025127NOPA	1003269	Normally Open	Yes	230	Pipe Clamp	30
40025119NCOZ	1003237	Normally Closed	Yes	120	Pipe Clamp	10
40025119NCPA	1003239	Normally Closed	Yes	230	Pipe Clamp	10
40025108NCOZ	1003249	Normally Closed	Yes	120	Pipe Clamp	15
40025108NCPA	1003251	Normally Closed	Yes	230	Pipe Clamp	15
40025123NCOZ	1003261	Normally Closed	Yes	120	Pipe Clamp	20
40025123NCPA	1003263	Normally Closed	Yes	230	Pipe Clamp	20
40025127NCOZ	1003273	Normally Closed	Yes	120	Pipe Clamp	30
40025127NCPA	1003275	Normally Closed	Yes	230	Pipe Clamp	30

SPECIFICATIONS

TYPE	Pump-Duty, Wide Angle
ELECTRICAL RATING	125/250 VAC, 15 A Max Pump Running Current; 85 A Max Pump Starting Current
SWITCH ELEMENT	Mechanical
PUMPING RANGE	7 to 36", Adjustable
DIMENSIONS	3.05" Dia x 3.56" L
MAX OPERATING DEPTH (ft)	30
FLOAT MATERIAL	Polypropylene

SJE PumpMaster® Pump-Duty Float Switches

The mechanically activated PumpMaster Wide-Angle Pump Switches are designed for direct control of 1/2 HP @ 120 VAC or 1 HP @ 230 VAC pumps in water and sewage applications. The pump switches are not sensitive to rotation or turbulence allowing it to be used in both calm and turbulent applications.

FEATURES & BENEFITS

- Heavy-duty contacts
- Includes standard pipe mounting clamp
- Adjustable pumping range of 7 to 36"
- High-impact, corrosion-resistant float switches provide long service life

Note: Removing piggyback plug with models equipped with them negates UL/CSA approval. These switches must be used with pumps that provide integral thermal overload protection. These pump switches are designed for single-phase, horsepower rated loads and are not suitable for control/signal-duty applications (they will fail prematurely when switching loads less than 1 A at 120 VAC). Select a float switch designed for use for control/signal duty in this instance. Units used for direct wiring (without plug) may be used in either 120 VAC or 230 VAC applications within specified amp ratings. Ensure compliance with local electrical codes when using on 230VAC applications.

SPECIFICATIONS

TYPE	Pump-Duty, Wide Angle
ELECTRICAL RATING	125/250 VAC, 13 A Max Pump Running current; 85 A Max Pump Starting Current
SWITCH ELEMENT	Mechanical
PUMPING RANGE	7 to 36", Adjustable
DIMENSIONS	3.05" Dia x 3.56" L
MAX OPERATING DEPTH (ft)	30
FLOAT MATERIAL	Polypropylene

CERTIFICATIONS

- UL, CSA



C&M PART #	MFG PART #	SWITCH TYPE	PIGGYBACK PLUG	PLUG VOLTAGE RATING (VAC)	MOUNTING	CABLE LENGTH (ft)
40026719NO	1002712	Normally Open	No	—	Pipe Clamp	10
40026708NO	1002719	Normally Open	No	—	Pipe Clamp	15
40026723NO	1002731	Normally Open	No	—	Pipe Clamp	20
40026727NO	1002743	Normally Open	No	—	Pipe Clamp	30
40026719NC	1002706	Normally Closed	No	—	Pipe Clamp	10
40026723NC	1002737	Normally Closed	No	—	Pipe Clamp	20
40026727NC	1002749	Normally Closed	No	—	Pipe Clamp	30
40027419NOOZ	1002630	Normally Open	Yes	120	Pipe Clamp	10
40027423NOOZ	1002727	Normally Open	Yes	120	Pipe Clamp	20
40027427NOOZ	1002739	Normally Open	Yes	120	Pipe Clamp	30
40027408NCOZ	1002721	Normally Closed	Yes	120	Pipe Clamp	15
40027408NCPC	1002725	Normally Closed	No	—	Pipe Clamp	15
40027423NCOZ	1002733	Normally Closed	Yes	120	Pipe Clamp	20
40027427NCOZ	1002745	Normally Closed	Yes	120	Pipe Clamp	30

SJE Double Float® Master Pump Switches

These mechanically activated Double Float Master Pump Switches provide automatic control of pumps up to 15 FLA @ 120 VAC. They are well suited for confined applications requiring an accurate pumping range. Each pump switch consists of two mechanical floats and a splice tube. The splice tube contains a holding relay which enables the floats to function in series. The holding relay eliminates pump chatter in turbulent conditions. This switch is voltage sensitive—use with correct voltage.

FEATURES & BENEFITS

- Includes standard pipe mounting clamps
- Adjustable pumping range of 3 to 48"
- Not sensitive to rotation or turbulence

Note: This switch must be used with pumps that provide integral thermal overload protection.

SPECIFICATIONS

TYPE	Pump-Duty, Wide Angle
ELECTRICAL RATING	120 VAC & 240 VAC; 15 A max Pump Running Current, 90 A max Pump Start Current
SWITCH ELEMENT	Mechanical
PUMPING RANGE	3 to 48", Adjustable
DIMENSIONS	2.74" Dia x 4.83" L
FLOAT MATERIAL	Polypropylene

CERTIFICATIONS

- UL, CSA



C&M PART #	MFG PART #	SWITCH TYPE	PIGGYBACK PLUG	PLUG VOLTAGE RATING (VAC)	MOUNTING	CABLE LENGTH (ft)
400285	1016864	Normally Open	Yes	120	Pipe Clamp	15
400286	1017657	Normally Open	Yes	240	Pipe Clamp	15
400287	1017660	Normally Open	Yes	120	Pipe Clamp	20
400288	1017661	Normally Open	Yes	240	Pipe Clamp	20
400289	1017662	Normally Open	No	120	Pipe Clamp	20
400290	1017663	Normally Open	No	240	Pipe Clamp	20
400291	1017664	Normally Open	Yes	120	Pipe Clamp	30
400292	1017665	Normally Open	Yes	240	Pipe Clamp	30



Float Switch Accessories

Brackets are designed to keep multiple float switches organized within the basin. All brackets are made of Type 304 stainless steel (SS) and come with black cord snubbers to securely attach float cables. Additionally, the T-type brackets are supplied with a mounting piece so the bracket itself may be easily removed from the basin with the floats still attached.

Cable Weight clamps securely to the cable with two stainless steel screws (included). Weight may also be used in turbulent conditions to stabilize other level measurement devices such as submersible transmitters.

Stainless Steel Pipe Clamp secures the float switch cable while making it easy for you to change the positions or level of the float switch.



C&M PART #	MFG PART #	DESCRIPTION	DIMENSIONS
104699	3FB	Three-Hole L-Type SS Bracket with Three Bushings	6-1/2"L x 1-1/2"W x 3-1/2"H
104700	4FB	Four-Hole T-Type SS Bracket with Mounting Bracket and Four Bushings	6-1/2"L x 13"W x 4"H
104701	6FB	Six-Hole T-Type SS Bracket with Mounting Bracket and Six Bushings	6-1/2"L x 20-1/2" W x 3-1/2"H
104702	4SFB	Four-Hole SS Float Bracket with Four U-Shaped Bushings	6-1/2"L x 13"W x 4"H
104703	4HB	Four-Hook Stainless Steel T-Type Float Bracket with Side Hooks and Mounting Bracket	6"L x 12"W x 4"H
104704	6HB	Six-Hook Stainless Steel Float Bracket, & Mounting Bracket	19-1/4"W x 7"H
104705	4AHB	Four-Hook U Type Stainless Steel Float Bracket	13"W x 7"H
104706	6AHB	Six-Hook U-Type Stainless Steel Float Bracket	19-1/4"W x 7"H
104707	C10	Zinc Plated Cast Iron Cable Weight and Screws (1.22 lbs)	Fits 1/4" Diameter Cables
104853	C30	SS Clamp for Pipe Mount	For 2" to 3-1/2" Pipe Diameters

SJE Junction Boxes & Cable Connectors



Junction boxes provide a convenient location to connect all wiring required for a typical pumping station, on-site system or other electrical installation. They seal electrical connections from moisture and other elements. Lid and box made from high impact, corrosion resistant, weatherproof thermoplastic.

FEATURES & BENEFITS

- NEMA 4X, UL Listed, CSA Certified enclosure
- External mounting feet included
- UL Listed and CSA Certified Hub for incoming power/control wires through conduit

Note: Small HP pump enclosures = pump cable 18/2 to 14/3 gauge, Large HP pump enclosures = pump cable 14/4 to 10/3 gauge. 1.5H = 1-1/2" Hub, 2H = 2" Hub. R8 = RCC8, R12 = RCC12.

CERTIFICATIONS

- UL, CSA

C&M PART #	MFG PART #	DESCRIPTION (NUMBER BEFORE R8 OR R12 EQUALS NUMBER OF CONNECTORS OF THAT SIZE INSTALLED)
400319	1008549	SJE Junction Box, JB664-1.5H-4R8 Simplex (use w/small HP pump), 6"x6"x4", 1-1/2" Hub size
400320	1008550	SJE Junction Box, JB664-2H-5R8 Duplex (use w/small HP pump), 6"x6"x4", 2" Hub size
400321	1008551	SJE Junction Box, JB664-1.5H-3R8-1R12 Simplex (use w/large HP Pump), 6"x6"x4", 1-1/2" Hub size
400322	1008552	SJE Junction Box, JB664-2H-3R8-2R12 Duplex (use w/large HP Pump), 6"x6"x4", 2" Hub size
400323	1002574	SJE Cable Connector, 1/2" Round (RCC-8)
400324	1002575	SJE Cable Connector, 3/4" Round (RCC-12)
400325	1009868	SJE Cable Connector, 1" Round (RCC-16)
400326	1002576	SJE Cable Connector, 1/2" Flat UF (UFCC-8)
400327	1002577	SJE Cable Connector, 3/4" Flat UF (UFCC-12)

SJE Tank Alert® AB & AB DUO Alarm Systems

The Tank Alert® AB (auto reset, battery backup) Indoor Alarm System provides audio/visual warning of potential threatening liquid level conditions in lift pump chambers, sump pump basins, holding tanks, sewage, agricultural and other water applications.



If an alarm condition occurs, the horn sounds and the alarm light activates. The horn can be silenced, but the alarm light remains on until the condition is remedied. Once the condition is cleared, the alarm will automatically reset. A green "Power On" light indicates 120 VAC primary power to the alarm. Low battery chirp feature indicates when battery should be replaced. Switch mechanism operates on low voltage and is isolated from the power line to reduce the possibility of shock. Both models feature an alarm test switch and horn silence button switch.

Select from Tank Alert AB or AB DUO models. Tank Alert AB DUO models allow you to monitor two liquid level conditions. They feature a second float switch input and red alarm 1, yellow alarm 2 and green power on lights.

FEATURES & BENEFITS

- NEMA 1 enclosure for indoor use
- Automatic alarm reset
- Battery backup powers unit if primary power fails
- External terminal block for easy installation of float switch

INCLUDES

All models include SignalMaster® control switch, normally open, mechanical, 15 ft cable, pipe clamp mounting

SPECIFICATIONS

VOLTAGE	120 VAC
BATTERY BACKUP POWER	9 VDC
ENCLOSURE DIMENSIONS	6" x 4" x 2.25"
ENCLOSURE RATING	NEMA 1, Indoor Use
POWER CORD (ft)	6
ALARM HORN (DECIBELS)	87 @ 10 ft
FLOAT SWITCH DIMENSIONS	2.74" Dia x 4.83" L
MAXIMUM WATER DEPTH, FLOAT SWITCH (ft)	30
POWER	120 VAC

CERTIFICATIONS

- UL, CSA

C&M PART #	MFG PART #	DESCRIPTION
400246	1011421	TA AB-01H, Tank Alert AB with 15-ft SignalMaster float switch
400249	1036378	TA AB DUO-01H, Tank Alert AB DUO with 15-ft SignalMaster float switch

SJE Tank Alert® EZ Alarm Systems

Tank Alert Alarm Systems provide audio/visual warning of potential threatening liquid level conditions in lift pump chambers, sump pump basins, holding tanks, sewage, agricultural and other water applications. The alarms feature an innovative, sleek two-color molded enclosure which integrates the LED red translucent beacon; the upper half illuminates and horn sounds when an alarm condition occurs.



Interlocking enclosure features unique sound chamber to amplify the horn while helping prevent moisture from entering. Once the condition is cleared, the alarm automatically resets. Standard features include an alarm test/silence switch, green power on indicator, and auxiliary contacts for remote devices.

The patented Tank Alert EZ alarm system is all about making installations easier! They feature external mounting tabs for quick, easy installation and removable cover that provides greater access for easier field wiring while the internal circuitry remains protected.

FEATURES & BENEFITS

- Two-color molded enclosure offers a distinct look; translucent upper half illuminates in an alarm condition
- Interlocking enclosure amplifies the horn and prevents moisture from entering
- Indicator marks on the bottom of enclosure for easy placement of cord entry locations
- Automatic alarm reset, horn silence switch and alarm test switch
- Includes auxiliary contacts for remote devices

INCLUDES

All models include SignalMaster® control switch, normally open, mechanical, 15-ft cable, pipe clamp mounting; Select from optional model that includes premounted terminal block so enclosure can also be used as a junction box for splicing pump, pump switch, and pump power; meets NEC standard for junction boxes

SPECIFICATIONS

VOLTAGE	120 VAC
ENCLOSURE DIMENSIONS	6.7" x 5.3" x 2.5"
ENCLOSURE RATING	3R, Watertight
ALARM HORN (DECIBELS)	82 @ 10 ft
FLOAT SWITCH DIMENSIONS	2.74" Dia x 4.83" L
MAXIMUM WATER DEPTH, FLOAT SWITCH (ft)	30
POWER	120 VAC

CERTIFICATIONS

- CSA

C&M PART #	MFG PART #	DESCRIPTION	PREMOUNTED TERMINAL BLOCK
400247	1036589	TAEZ-01H, Tank Alert EZ with 15-ft SignalMaster High Level	No
400248	1036592	TAEZ-01HTB, Tank Alert EZ with 15-ft SignalMaster High Level Terminal Block	Yes

KELLER LevelRat Lift Station Submersible Level Transmitters

Specifically designed for extended service in sewage lift station environments, the LevelRat by KELLER America features a wide sensing diaphragm yet small overall size. The LevelRat incorporates a monolithic diaphragm which combines the non-stick quality of Teflon with superior toughness and abrasion resistance. Transmitters feature a 3" protective guard. Select from transmitters with or without integral conduit fitting.



FEATURES & BENEFITS

- Perfectly suited for pump control in lift station applications
- KELLER America's guaranteed lightning protection included at no additional cost
- Ideal for areas prone to chronic damage due to transients caused by lightning
- Protective spacer provides additional protection for sensing element in harsh conditions

SPECIFICATIONS

ACCURACY	+/- 1%
WETTED MATERIAL (CABLE)	Polyethylene
WETTED MATERIAL (BODY)	316 SS
LIGHTNING PROTECTION	Yes
POWER	11-32 VDC
OUTPUT	4 to 20mA, RS485
DIMENSIONS	3" Dia x 6" L
PROTECTION RATING	IP 68

CERTIFICATIONS

- cULus Listed

C&M PART #	MFG PART #	RANGE (PSI)	RANGE (ft/H ₂ O)	CABLE LENGTH (ft)
KELLER LEVELRAT WITHOUT 1/2" NPT(M) CONDUIT FITTING				
104894	1071.01202.051307.13	0-5	0-11.55	30
104896	1071.01302.051307.13	0-10	0-23.10	30
104898	1071.00102.051311.13	0-15	0-34.65	50
104900	1071.01602.051312.13	0-20	0-46.20	60
104902	1071.02002.051315.13	0-30	0-69.30	90
KELLER LEVELRAT WITH 1/2" NPT(M) CONDUIT FITTING				
104895	1071.01202.051907.13	0-5	0-11.55	30
104897	1071.01302.051907.13	0-10	0-23.10	30
104899	1071.00102.051911.13	0-15	0-34.65	50
104901	1071.01602.051912.13	0-20	0-46.20	60
104903	1071.02002.051915.13	0-30	0-69.30	90

REPLACEMENT PARTS & ACCESSORIES

C&M PART #	MFG PART #	DESCRIPTION
104942	900001.0002	Drying Tube Assembly
104943	900001.0009	Bellows Assembly
104944	HU02216001	Hubbell Cable Hanger
104945	900001.0034	Termination Enclosure - Universal for Drying Tube or Bellows
104946	900001.0034-1	Termination Enclosure - Drying Tube included
104947	900001.0034-2	Termination Enclosure - Bellows included
104948	1820-28-A3	Bourns Signal Line Protector
104949	900001.0033	Zinc Anode/Stabilizing Weight

KELLER Levelgag General Purpose Submersible Level Transmitter

The Levelgag submersible level transmitter is certified to NSF/ANSI 61 and 372 standards for use in drinking water applications in addition to the outstanding performance it provides in a wide array of applications, from water storage and distribution and is ideally suited for most fresh water monitoring applications. Additionally, models equipped with 4 to 20mA analog output include guaranteed lightning protection at no additional cost. This feature protects the Levelgag from fast-rising transients and carries a lifetime guarantee against damage from electrical surge.



FEATURES & BENEFITS

- General purpose submersible transmitter provides standard features that far exceed those of comparably priced instruments
- KELLER America's guaranteed lightning protection included at no additional cost
- Ideal for areas prone to chronic damage due to transients caused by lightning
- Certified for use in drinking water applications

SPECIFICATIONS

ACCURACY	+/- 1%
WETTED MATERIAL (CABLE)	Polyethylene, EPDM seals
WETTED MATERIAL (BODY)	316 SS
LIGHTNING PROTECTION	Yes
POWER	11-28 VDC
OUTPUT	4 to 20mA
DIMENSIONS	0.825" Dia x 4.13" L
PROTECTION RATING	IP68

CERTIFICATIONS

- UL, NSF/ANSI 372 & 61

C&M PART #	MFG PART #	RANGE (PSI)	RANGE (ft/H ₂ O)	CABLE LENGTH (FT)
104904	0407.01202.021307.13	0-5	0-11.55	30
104905	0407.01302.021307.13	0-10	0-23.10	30
104906	0407.00102.021311.13	0-15	0-34.65	50
104907	0407.01602.021312.13	0-20	0-46.20	60
104908	0407.02002.021315.13	0-30	0-69.30	90

KELLER Microlevel Microbore Submersible Level Transmitters

The KELLER Microlevel Microbore submersible level transmitter provides you with high accuracy in a class-leading housing diameter of only 0.63". It incorporates Keller's proven microprocessor-controlled signal conditioning to provide outstanding accuracy. Use them for small bore applications where space is limited such as ground water monitoring, well monitoring, environmental remediation, surface water monitoring, downhole and water tanks. Select from 316 SS or Titanium body transmitters. Includes KELLER's guaranteed lightning protection.



FEATURES & BENEFITS

- The Microlevel by KELLER America is the smallest diameter in its class, specifically designed for applications that demand small size and high performance
- KELLER America's guaranteed lightning protection included at no additional cost
- Ideal for areas prone to chronic damage due to transients caused by lightning
- Certified for use in drinking water applications

SPECIFICATIONS

ACCURACY	0.25% of range
WETTED MATERIAL (CABLE)	Polyethylene, EPDM seal
WETTED MATERIAL (BODY)	316L SS or Titanium
LIGHTNING PROTECTION	Yes
POWER	10 to 30 VDC
OUTPUT	4 to 20mA, RS485
DIMENSIONS:	0.63" Dia x 5.33"L
PROTECTION RATING	IP 68

CERTIFICATIONS

- UL, NSF/ANSI 61 and 372

C&M PART #	MFG PART #	RANGE (PSI)	RANGE (ft/H ₂ O)	CABLE LENGTH (ft)
KELLER MICROLEVEL MICROBORE SUBMERSIBLE LEVEL TRANSMITTER, 316L BODY				
104909	1127.00107.051309	0-6.5	0-15	40
104911	1127.01607.051309	0-8.67	0-20	40
104913	1127.02007.051311	0-13.0	0-30	50
104915	1127.00207.051313	0-21.66	0-50	70
104917	1127.00307.051318	0-43.33	0-100	120
104919	1127.02107.0513105	0-64.99	0-150	170
104921	1127.01107.0513119	0-86.66	0-200	220
104923	1127.10707.0513151	0-151.65	0-350	370
KELLER MICROLEVEL MICROBORE SUBMERSIBLE LEVEL TRANSMITTER, TITANIUM BODY				
104910	1127.00107.051309.17	0-6.5	0-15	40
104912	1127.01607.051309.17	0-8.67	0-20	40
104914	1127.02007.051311.17	0-13.0	0-30	50
104916	1127.00207.051313.17	0-21.66	0-50	70
104918	1127.00307.051318.17	0-43.33	0-100	120
104920	1127.02107.0513105.17	0-64.99	0-150	170
104922	1127.01107.0513119.17	0-86.66	0-200	220
104924	1127.10707.0513151.17	0-151.65	0-350	370

REPLACEMENT PARTS & ACCESSORIES

C&M PART #	MFG PART #	DESCRIPTION
104942	900001.0002	Drying Tube Assembly
104943	900001.0009	Bellows Assembly
104944	HU02216001	Hubbell Cable Hanger
104945	900001.0034	Termination Enclosure - Universal for Drying Tube or Bellows
104946	900001.0034-1	Termination Enclosure - Drying Tube included
104947	900001.0034-2	Termination Enclosure - Bellows included
104948	1820-28-A3	Bourns Signal Line Protector
104949	900001.0033	Zinc Anode/Stabilizing Weight

SUGGESTED PRODUCTS

Core & Main Pure EZ Lift, Station Degreaser

This powerful soy-based Lift Station Degreaser contains 95% soy and 5% d-limonene to effectively cut down the grease. It dissolves heavy grease and fat accumulations on walls and creates odor absorbing barrier to control odors while leaving a pleasant citrus scent. This degreaser will not harm bacterial action in sewage treatment plants.



FEATURES & BENEFITS

- Floats on the surface so it will rise and fall with the level of the wastewater
- Color indication lets you know when more is needed
- High soy content allows for a longer shelf life
- 100% natural biodegradable formula

C&M PART #	MFG PART #	PACKAGE SIZE	QUANTITY
105038	7010041	1 Gallon Bottle	Pack of 4
105039	7010005	5 Gallon Pail	1 Each

KELLER Acculevel High Accuracy Submersible Level Transmitter

The Acculevel by Keller America provides standard features that far exceed those of comparably priced transmitters. The Acculevel transmitter provides you with high accuracy performance suited to a wide range of applications, including drinking water, stream and reservoir level, environmental monitoring and tank level. Titanium body for use in more aggressive media applications not suited for stainless steel, notably seawater.

FEATURES & BENEFITS

- High Accuracy, thermally compensated, incorporates microprocessor-controlled signal conditioning
- KELLER America's guaranteed lightning protection included at no additional cost
- Ideal for areas prone to chronic damage due to transients caused by lightning
- Certified for use in drinking water applications



SPECIFICATIONS

ACCURACY	+/-0.25% of range
WETTED MATERIAL (CABLE)	Polyethylene, EPDM seals
WETTED MATERIAL (BODY)	Titanium
LIGHTNING PROTECTION	Yes
POWER	11-28 VDC
OUTPUT	4 to 20mA, RS485
DIMENSIONS:	0.825"Dia x 4.13"L
PROTECTION RATING	IP68

CERTIFICATIONS

- UL, NSF/ANSI 61 & 372

C&M PART #	MFG PART #	RANGE (PSI)	RANGE (ft/H ₂ O)	CABLE LENGTH (ft)
104950	0507.01202.051307.60	0-5	0-11.55	30
104951	0507.01302.051307.60	0-10	0-23.10	30
104952	0507.00102.051311.60	0-15	0-34.65	50
104953	0507.01602.051312.60	0-20	0-46.20	60
104954	0507.02002.051315.60	0-25	0-69.30	90

REPLACEMENT PARTS & ACCESSORIES

C&M PART #	MFG PART #	DESCRIPTION
104942	900001.0002	Drying Tube Assembly
104943	900001.0009	Bellows Assembly
104944	HU02216001	Hubbell Cable Hanger
104945	900001.0034	Termination Enclosure - Universal for Drying Tube or Bellows
104946	900001.0034-1	Termination Enclosure - Drying Tube included
104947	900001.0034-2	Termination Enclosure - Bellows included
104948	1820-28-A3	Bourns Signal Line Protector
104949	900001.0033	Zinc Anode/Stabilizing Weight

Submersible Transmitter Accessories

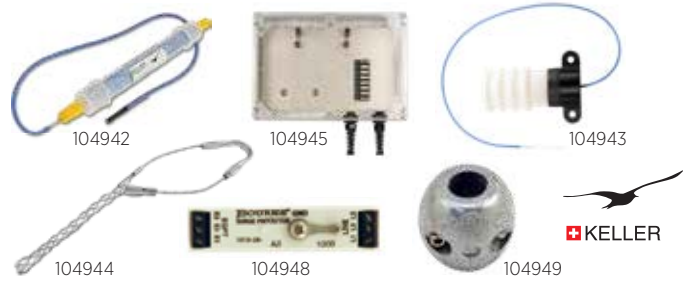

Drying Tube Assembly attaches directly to cable vent tube to intercept water vapor. Clear tube is filled with indicating desiccant; periodically renew desiccant as it becomes saturated, turning from blue (dry) to pink (saturated). Highly recommended when operating in high humidity conditions.

Bellows Assembly attaches to cable vent tube and is an alternative to the drying tube. It requires no periodic maintenance. Note that the use of the bellows results in a closed reference pressure system subject to zero shift errors induced by changing temperatures of up to 0.0004 psi/°C. Not recommended for use with accuracy requirements of ±0.25% FS or better, or ranges < 2 psi.

Cable Hanger: Single eye mesh cord grip style cable hanger for use with KELLER's 0.230" OD cables.

Termination Enclosure: Convenient option complementing gauge-type pressure/level transmitters, where it is desired to terminate the transmitter cable close to the measurement point. It includes a NEMA 4X clear front enclosure (7.9" x 4.7" x 3.5") with two, liquid-tight cable fittings (one in, one out), a terminal strip, and provisions for mounting both a drying tube or bellows assembly.

Bourns® Model 1820 Signal Line Protector protect sensitive circuits and components from damaging voltage and currents. Its extremely fast response and low clamping voltage make it suitable for the protection of signal and data lines. Place the protector at each end of a signal or data line or current loop for best protection. The signal line protector provides both line-to-ground and line-to-line protection and are designed to use on 4 to 20 mA current loops.

Stabilizing Weight: Zinc prop shaft anode adapted to fit Ø21 mm OD of Levelgage, Acculevel and LevelRat submersible level transmitters. It provides corrosion resistance as well as helps ensure that the cable remains taut in turbulent conditions.

C&M PART #	MFG PART #	DESCRIPTION
104942	900001.0002	Drying Tube Assembly
104943	900001.0009	Bellows Assembly
104944	HU02216001	Hubbell Cable Hanger
104945	900001.0034	Termination Enclosure, Universal for Drying Tube or Bellows
104946	900001.0034-1	Termination Enclosure, Drying Tube included
104947	900001.0034-2	Termination Enclosure, Bellows included
104948	1820-28-A3	Bourns Signal Line Protector
104949	900001.0033	Zinc Anode/Stabilizing Weight

LIFTX Lift Station Monitors



LIFTX Monitors provide cloud/internet-based monitoring and reporting of remote lift station conditions. Monitors use WebAdvantage, a cloud-based remote alarming and reporting tool, to obtain high/low level, pump performance, pressure, temperature, motor current draw, generator switch over, loss of power, security and more. WebAdvantage provides web-based access of settings, conditions, e-mail alarming to multiple users and unique custom reporting. Monitors feature user friendly, custom keypad/display for setup, programming, and alerts. Units come complete with the first 12 months of cellular service for easy start-up and web connectivity.

FEATURES & BENEFITS

- Built-In cellular connection
- Web/cloud-based access to alarms, status, reports and setting changes
- Customizable info/naming and notepad
- Custom alerts/alarms by email and on-site display
- WebAdvantage reporting
- Readily customized dashboard and reporting capabilities

INCLUDES

Standard conduit connections for incoming power, delayed start cell service (cellular service must be activated within 4 months of purchase of unit), integrated cellular router/antenna, first 12-months cellular service (Verizon), WebAdvantage internet access and 10 customizable notepad entry

Note: Product activation (Webadvantage and Cellular Service) needed at startup. Please contact us to order quick ship units with optional totalizing flow meter inputs, AT&T™ cellular service, output control relays or built-in 24 VDC transmitter power supply.

SPECIFICATIONS

POWER	95 to 240 VAC, 50/60 Hz
DISPLAY	240 x 128 Graphic LCD
ENCLOSURE	Heavy Duty, NEMA 4X, High Impact ABS with Padlockable Gasketed Lexan Cover
ENVIRONMENTAL RATING	0 to 125°F
DIMENSIONS	8.94" W x 11.25" H

C&M PART #	MFG PART #	DIGITAL INPUTS	4 TO 20 MA INPUTS
401926	LIFTX-S	5	0
401927	LIFTX-N4S	5	4
401928	LIFTX-LN8S	10	8

Precision Digital PD765 Trident Digital Panel Meter / Level Process Controller

The PD765 Trident Digital Panel Meter is one of the most versatile digital panel meters on the market and will satisfy a wide variety of process and temperature applications. Easily field program meter to accept process voltage (0 to 5 V, 1 to 5 V, etc.); current (4 to 20 mA); 100 Ω RTDs or type J, K, T, or E thermocouple inputs.



Program and setup using the four front panel pushbuttons or by using the free MeterView™ software. Password protection restricts modification of programmed settings. Units with relay output option have functionalities that include automatic reset only, auto/manual reset, latching/non latching, pump alternation control, on/off time delays from 0 to 199 seconds and fail-safe operation. Adjust the intensity of the display to compensate for various lighting conditions, including direct sunlight.

FEATURES & BENEFITS

- Provides 24 VDC to power the transmitter's 4 to 20 mA signal
- 1/8 DIN panel meter with NEMA 4X, IP65 front
- Shallow depth case extends only 3.6" (91.4 mm) behind panel
- 4-digit LED display, 0.56" (14.2 mm) H
- Free PC-based MeterView programming & monitoring software
- High & low alarms with multiple reset actions
- Max/Min display

SPECIFICATIONS

ACCURACY	±0.05% of Calibrated Span
POWER	85 to 265 VAC
DISPLAY	0.56", 4-Digits, Red LED (-1999 to 9999)
ENCLOSURE	NEMA 4X, 1/8 DIN, Plastic
INPUTS (FIELD SELECTABLE)	4 to 20 mA; ±10 VDC; 0 to 5 VDC; 1 to 5 VDC; J, K, T or E Thermocouple; or 100 Ω Platinum RTD
RELAYS	2 SPDT, Form C
RATING	3 A @ 250 VAC Resistive
DEADBAND	0 to 100% of Full Scale, User Selectable
OPERATION	Automatic, Latching, Pump Alternation
TIME DELAY	0 to 199 Seconds On or Off
RESET	Auto or Manual, User Selectable
OPERATING TEMPERATURE RANGE	-40 to 65°C (-40 to 150°F)

CERTIFICATIONS

- CE, UL, cUL

C&M PART #	MFG PART #	OPTIONS INSTALLED
1072790605	PD765-6R0-00	None
1072790601	PD765-6R0-10	24 VDC Transmitter Supply
1072790105	PD765-6R2-00	2 Relay Outputs
1072790101	PD765-6R2-10	2 Relay Outputs, 24 VDC Transmitter Supply
1072790205	PD765-6R3-00	4 to 20 mA Output
1072790201	PD765-6R3-10	4 to 20 mA Output, 24 VDC Transmitter Supply
1072790401	PD765-6R5-10	2 Relay Outputs, 4 to 20 mA Output, 24 VDC Transmitter Supply

Precision Digital ProVu Digital Panel Meter / Level Process Controller

The ProVu meters boast specifications, features and functionalities that make it the only 1/8 DIN process meter you will ever need. They accept both current and voltage input signals and are ideal for level, flow rate, temperature or pressure applications. The built-in 24 VDC power supply to drive transmitter not only saves the cost of an external power supply, but also greatly simplifies wiring.



The NEMA 4X rated front panel allows for installations exposed to moisture, dust, and other adverse conditions. View up to 999,999 on the upper line of the 6-digit dual-line LED display and show either a tag or the input in a different scale on the lower line. Configure the main display to indicate process value, resettable maximum or minimum value, alternating or alarm set points. Secondary display can be set to indicate engineering units, setpoints or user-defined legends or simply turned off. Other key features include advanced signal input conditioning like automatic round horizontal tank linearization (enter diameter and length), function keys, pump alternation capability and Modbus RTU serial communications. All models feature time delays for each relay and adjustable deadbands. Choose from controllers with one or two input channels; each input is programmed independently.

FEATURES & BENEFITS

- 0 to 20 mA, 4 to 20 mA, 0 to 5 V, 1 to 5 V and ± 10 V field selectable inputs
- Math functions include: addition, difference, average, multiplication, division, weighted average, ratio, concentration, and more
- Easily view Minimum or Maximum values
- Large 6-digit, dual-line LED display, 0.60" & 0.46"
- Programmable Display & Function Keys
- Modbus RTU Communication Protocol Standard
- Onboard USB and free PC-based, MeterView® Pro USB Programming Software

INCLUDES

USB cable

SPECIFICATIONS

ACCURACY	$\pm 0.03\%$ of calibrated span, ± 1 count
POWER	85 to 265 VAC
DISPLAY	Upper Display 0.60", Lower Display 0.46"
ENCLOSURE	NEMA 4X, IP65 front, 1/8 DIN
INPUTS (ANALOG, FIELD SELECTABLE)	1 or 2 (Depending on Model); 4 to 20 mA, 0 to 5 VDC, 1 to 5 VDC, 0 to 10 VDC
INPUTS (DIGITAL)	1
RELAYS	2 or 4 SPDT, Form C (Depending on Model)
RATING	3 A @ 125/250 Resistive Load
DEADBAND	0 to 100% of Span, User Adjustable
OPERATION	Auto, Latching, Sampling, Pump Alternation Control, Off, Manual Control Mode
TIME DELAY	0 to 999.9 Seconds, On and Off Relay
RESET	Auto or Manual, User Selectable
MEMORY	Nonvolatile, 10 years
OPERATING TEMPERATURE RANGE	-40 to 65°C (-40 to 150°F)

CERTIFICATIONS

- UL, cUL

C&M PART #	MFG PART #	OPTIONS INSTALLED (24 VDC TRANSMITTER POWER SUPPLY IS STANDARD ON ALL MODELS)
PROVU DISPLAY/CONTROLLERS WITH SINGLE INPUT		
1072860101	PD6000-6R2	2 Relay Outputs
1072860402	PD6000-6R5	2 Relay Outputs, 4 to 20 mA Output
1072860301	PD6000-6R4	4 Relay Outputs
1072860502	PD6000-6R7	4 Relay Outputs, 4 to 20 mA Output
PROVU DISPLAY/CONTROLLERS WITH DUAL INPUT		
1072900101	PD6060-6R2	2 Relay Outputs
1072900402	PD6060-6R5	2 Relay Outputs, 4 to 20 mA Output
1072900301	PD6060-6R4	4 Relay Outputs
1072900502	PD6060-6R7	4 Relay Outputs, 4 to 20 mA Output

PEABODY PROCHEM® PROCESS CHEMICAL TANKS

The ProChem Process Chemical Tanks are designed for agricultural and industrial chemical applications where a single-walled design is desired.

See our Process Chemical Tanks on **page 418** for more information.



Zoeller Pivot® Pump Control Panels

Zoeller Pivot pump controllers are single phase only and include many standard features in a high-quality panel. Smart Hand/Off/Auto (HOA) prevents accidental on or off and provides you with an off-mode reminder. HOA selection modes are Service Off (alarm active), Permanent Off (alarm inactive); Simplex Mode, Duplex Mode (simultaneous pump run enabled or alternating mode where the simultaneous pump run is not enabled). Smart HOA Switch (float smart logic) allows you to select three or four (duplex) floats, SLLH (Stop, Lead, Lag, High Alarm) or SLHL (Stop, Lead, High Alarm, Lag) float order.

Touch-safe user interface features LED indicators for system ready, float switch faults, pump run and float switch. Alarm conditions include high water, high voltage, disabled alarm circuit, float fault, continuous pump run, failed contactor and service off timeout. Top mount red globe alarm displays varying globe patterns for distinct alarm conditions.

FEATURES & BENEFITS

- Rugged NEMA 4X enclosure offers protection from corrosion and extreme environments
- Motor contactors with built-in pump run contacts
- Terminal strip for circuit and alarm power, float switches and aux contacts
- Configurable active/latching side mount horn and test/silence switch
- Hand/Off/Auto control are included for each pump
- Auxiliary output dry contacts (NO-COM-NC) terminals, Form C, 5 A resistive Auxiliary output dry contact (NO-COM-NC) terminals for alarm conditions, Form C, 5 A resistive
- Alarm circuit can be powered separately from circuit breaker
- Pump-run dry contact, normally open
- Separate fuses for alarm and control circuits
- USB port features: pump cycle counter, elapsed time meter, update firmware



SPECIFICATIONS

ENCLOSURE RATING	NEMA 4X
PANEL DIMENSIONS (W x H x D)	10" x 12" x 6" with Lockable Hasp
SIREN RATING (DECIBEL)	95
CONTACTORS	IEC rated
INPUTS	Simplex units up to 3 floats, Duplex units up to 4 floats

CERTIFICATIONS

- CSA certified to standard UL508

C&M PART #	MFG PART #	VOLTAGE (VAC)	PHASE	FULL LOAD (AMPS)	BREAKER RATING (AMPS)
SIMPLEX PUMP CONTROL PANELS					
106128263009	31314-0001	120/208/240	1	0 to 7	15
106128273009	31324-0001	120/208/240	1	7 to 15	20
106128283009	31334-0001	120/208/240	1	15 to 20	30
106128293009	31344-0001	120/208/240	1	20 to 30	50
DUPLEX PUMP CONTROL PANELS					
1061322730DS	32124-0001	120	1	7 to 15	20
1061322830DS	32134-0001	120	1	15 to 20	30
106132263009	32314-0001	120/208/240	1	0 to 7	15
106132273009	32324-0001	120/208/240	1	7 to 15	20
106132283009	32334-0001	120/208/240	1	15 to 20	30
106132293009	32344-0001	120/208/240	1	20 to 30	50

Local Knowledge
Local Experience
Local Service, Nationwide®

Count on Core & Main to provide a quality product assortment from trusted brands, access to industry and product experts, and best-in-class service.



Zoeller Pivot® Pro Pump Control Panels

Use the Zoeller Pivot® Pro Pump Control Panels with advanced features to control your pumps. The Pivot Pro panels feature a user-friendly interface with LCD screen/menu, buttons, LEDs and seal fail adjustment screw. Controllers also includes an alternator 1-2 selector switch (lead/lag for duplex pump panels), thermal cutout indicator and dry contact alarms with seal/thermal conditions.

Smart Hand/Off/Auto (HOA) prevents accidental on or off and provides you with an off-mode reminder. HOA selection modes are Service Off (alarm active), Permanent Off (alarm inactive); Simplex Mode, Duplex Mode (simultaneous pump run enabled or alternating mode where the simultaneous pump run is not enabled). Smart HOA Switch (float smart logic) allows you to select three or four (duplex) floats, SLLH (Stop, Lead, Lag, High Alarm) or SLHL (Stop, Lead, High Alarm, Lag) float order.

Touch-safe user interface features LED indicators for system ready, float switch faults, pump run and float switch indicators. Alarm conditions include high water, high voltage, disabled alarm circuit, float fault, continuous pump run, failed contactor and service off timeout.

Additional alarms included are: seal fail (moisture) alarm, adjustable sensitivity, thermal indicator trip alarm and tripped overload (3-ph only). Top mount red globe alarm displays varying globe patterns for distinct alarm conditions.

FEATURES & BENEFITS

- LCD Display with button user interface menu: configure keypad lock for security, review pump cycle and elapsed run times, continuous run alarm timer, latching/active horn
- Rugged NEMA 4X enclosure offers protection from corrosion and extreme environments
- Motor IEC contactors with built-in pump run contacts, circuit breakers (1-ph only), overloads (3-ph only)
- Terminal strip for circuit and alarm power, float switches, aux contacts
- Configurable active/latching side mount horn, test/silence switch
- Hand/Off/Auto control are included for each pump
- Auxiliary output dry contacts (NO-COM-NC) terminals for alarm conditions, Form C, 5 A resistive
- Alarm circuit can be powered separately from circuit breaker
- Pump-run dry contact, normally open
- Separate fuses for alarm and control circuits protects the pump panel
- Multitap 200/230/460 transformer on 3-ph models
- Terminals for 120 VAC control power/alarm power, up to four float switches (duplex), pump input power
- Thermal cutout and seal fail indicators

SPECIFICATIONS

ENCLOSURE RATING	NEMA 4X
PANEL DIMENSIONS (W x H x D)	12" x 14" x 6" with Lockable Hasp (Part# 1061474187PF: 14" x 16" x 7")
SIREN RATING (DECIBEL)	95
CONTRACTORS	IEC rated
INPUTS	Simplex units up to 3 floats, Duplex units up to 4 floats, seal fail and thermal connections for each pump



CERTIFICATIONS

- CSA certified to standard UL508

C&M PART #	MFG PART #	VOLTAGE (VAC)	PHASE	FULL LOAD (AMPS)	BREAKER/OVERLOAD RATING (AMPS)
SIMPLEX PUMP CONTROL PANELS					
4002352630PC	11314-0001	120/208/240	1	0 to 7	15
4002352730PC	11324-0001	120/208/240	1	7 to 15	20
4002352830PC	11334-0001	120/208/240	1	15 to 20	30
4002352930PC	11344-0001	120/208/240	1	20 to 30	50
106138318710	114A4-0001	208/240/480	3	1.0 to 1.6	1.0 to 1.6
106138328710	114B4-0001	208/240/480	3	1.6 to 2.5	1.6 to 2.5
106138338710	114C4-0001	208/240/480	3	2.5 to 4.0	2.5 to 4.0
106138348710	114D4-0001	208/240/480	3	4.0 to 6.3	4.0 to 6.3
106138358710	114E4-0001	208/240/480	3	6 to 10	6 to 10
106138368710	114F4-0001	208/240/480	3	9 to 14	9 to 14
106138378710	114G4-0001	208/240/480	3	13 to 18	13 to 18
106138388710	114H4-0001	208/240/480	3	17 to 23	17 to 23
106138398710	114Q4-0001	208/240/480	3	20 to 25	20 to 25
DUPLEX PUMP CONTROL PANELS					
4002392730OZ	12124-0001	120	1	7 to 15	20
4002392830OZ	12134-0001	120	1	15 to 20	30
4002392630PC	12314-0001	120/208/240	1	0 to 7	15
4002392730PC	12324-0001	120/208/240	1	7 to 15	20
4002392830PC	12334-0001	120/208/240	1	15 to 20	30
4002392930PC	12344-0001	120/208/240	1	20 to 30	50
106147318710	124A4-0001	208/240/480	3	1.0 to 1.6	1.0 to 1.6
106147328710	124B4-0001	208/240/480	3	1.6 to 2.5	1.6 to 2.5
106147338710	124C4-0001	208/240/480	3	2.5 to 4	2.5 to 4
106147348710	124D4-0001	208/240/480	3	4 to 6.3	4 to 6.3
106147358710	124E4-0001	208/240/480	3	6 to 10	6 to 10
106147368710	124F4-0001	208/240/480	3	9 to 14	9 to 14
106147378710	124G4-0001	208/240/480	3	13 to 18	13 to 18
106147388710	124H4-0001	208/240/480	3	17 to 23	17 to 23
106147398710	124Q4-0001	208/240/480	3	20 to 25	20 to 25
106147408710	124R4-0001	208/240/480	3	23 to 32	23 to 32
106147418710	12404-0001	208/240/480	3	30 to 40	30 to 40

Ashcroft Pressure Switches

Use these B-Series Pressure Switches for a wide range of applications, including high and low limit control, safety shutdown and alarm functions commonly found in water and wastewater treatment plants. Use the single setpoint adjustment nut (7/8") located centrally at the bottom on the inside of the enclosure to adjust setpoints from 15 to 100% of pressure range. The pressure switches feature double-throw, switch elements for operation on increasing or decreasing pressure.



FEATURES & BENEFITS

- Highly reliable general-purpose pressure switch
- Adjustable setpoints from 15 to 100% of pressure range
- Fixed deadband

Note: Switches may generally be set between 15 and 100% of nominal range on increasing pressure. Ashcroft recommends regular inspection of the operation and setpoint of the switch in critical applications to prevent issues that could cause severe damage to personnel or property.

SPECIFICATIONS

ELECTRICAL RATING	SPDT 15 A @ 125/250 VAC
PROCESS CONNECTION	1/4" NPT(F)
ELECTRICAL CONNECTION	3/4" NPT(F), Conduit Hole, Right Side
WETTED MATERIALS	SS Fitting, Buna-N Diaphragm
DIMENSIONS	4" W x 2.75" H x 2.75" D
ENCLOSURE RATING	NEMA 4X
ENCLOSURE MATERIAL	Aluminum, Epoxy Coated

CERTIFICATIONS

- UL CSA

C&M PART #	MFG PART #	RANGE (PSI)	DEADBAND (FIXED, PSI)
40167397	B424B15#	2.25 to 15	0.5 to 1.5
40167398	B424B30#	4.5 to 30	0.5 to 1.5
40167399	B424B60#	9 to 60	1.0 to 3.5
4016730A	B424B100#	15 to 100	1.5 to 5.0
4016730B	B424B200#	30 to 200	5 to 13

KELLER Econoline General Purpose Transmitter

The Econoline pressure transmitter provides outstanding performance in a wide array of applications, from pipeline pressure to tank level monitoring. The Econoline pressure transmitter is built for 'next-level' performance at an optimum price point. It combines a proven media-isolated, piezoresistive silicon sensor with contemporary signal conditioning electronics to provide a compact pressure transmitter with class-leading Total Error Band accuracy. Ideal for tank, pump, and pipe pressure monitoring applications. The Econoline has been certified to NSF/ANSI 61 & 372 standards for use in drinking water applications.



KELLER

FEATURES & BENEFITS

- Provides trouble-free service and sufficient accuracy for almost any pressure measurement application
- Use where small size, low weight and reasonable cost are required

SPECIFICATIONS

ACCURACY	+/- 1% of full scale
WETTED MATERIALS	316L SS
PROCESS CONNECTION	1/4" NPT(M)
ELECTRICAL CONNECTION	Vented PVC cable
OUTPUT	4 to 20mA
POWER	8-32 VDC
RATING	IP54

CERTIFICATIONS

- NSF/ANSI 61 & 372

C&M PART #	MFG PART #	RANGE (PSI)	CABLE LENGTH (FT)
104925	0161.02002.020203	0-30	10
104926	0161.00202.020203	0-50	10
104927	0161.00302.020203	0-100	10
104928	0161.02102.020203	0-150	10
104929	0161.01102.020203	0-200	10

PRESSURE GAUGES

For pressure gauges such as Weksler's Liquid Filled Process Pressure Gauges and more, see our Gauges section on **page 203**.



KELLER Valueline High Accuracy Pressure Transmitters

The Valueline high accuracy pressure transmitter provides outstanding performance in any new or existing pressure measurement application. Ideally suited for pressure monitoring applications such as tank level measurement, pump control and VFD control. Units are fully submersible, making it an ideal choice when installed in a valve pit or other environment prone to periodic flooding. The transmitters include guaranteed lightning protection at no additional cost. This feature protects the pressure transmitter from fast-rising transients and carries a lifetime guarantee against damage from electrical surge.



KELLER

FEATURES & BENEFITS

- Provides you with standard features that far exceed those of comparably priced transmitters
- Uses KELLER's state-of-the-art signal conditioning circuitry
- Uses proven piezoresistive silicon sensor technology
- Certified for use in drinking water applications

SPECIFICATIONS

ACCURACY	+/-0.25% of range
WETTED MATERIALS	316 SS
PROCESS CONNECTION	1/4" NPT(M)
ELECTRICAL CONNECTION	Integral cable, flying leads
LIGHTNING PROTECTION	Yes
OUTPUT	4 to 20mA
POWER	11-28 VDC
RATING	IP68

CERTIFICATIONS

- NSF/ANSI 61 & 372

C&M PART #	MFG PART #	RANGE (PSI)	CABLE LENGTH (ft)
KELLER VALUELINE HIGH ACCURACY PRESSURE TRANSMITTERS			
104930	0208.00102.021303.13	0-15	10
104932	0208.02002.021303.13	0-30	10
104934	0208.00202.021303.13	0-50	10
104936	0208.00302.021303.13	0-100	10
104938	0208.02102.021303.13	0-150	10
104940	0208.01102.021303.13	0-200	10
KELLER VALUELINE HIGH ACCURACY PRESSURE TRANSMITTERS, WITH 1/2" NPT CONDUIT FITTING ELECTRICAL CONNECTION			
104931	0208.00102.021903.13	0-15	10
104933	0208.02002.021903.13	0-30	10
104935	0208.00202.021903.13	0-50	10
104937	0208.00302.021903.13	0-100	10
104939	0208.02102.021903.13	0-150	10
104941	0208.01102.021903.13	0-200	10

Rosemount® 2088 Gauge Pressure Transmitters

The 2088 Pressure Transmitters are specifically designed to meet the demands of municipal water and wastewater operators, providing accurate and reliable pressure measurement for critical applications. The transmitter features a solid-state polysilicon pressure sensor with a 316L SS isolating diaphragm for excellent chemical resistance. The transmitter features a robust design that can withstand extreme temperatures, moisture and corrosive substances commonly encountered in water and wastewater facilities.



401617

The transmitter comes with a range of mounting options, making installation quick and straightforward. It is compatible with various communication protocols, allowing seamless integration into existing control systems. Choose from blind (no display), display and local operator Interface (LOI) models. Models with LOI interface feature easy-to-use menus and built-in configuration buttons, so you can commission the device on the spot without complicated tools.

FEATURES & BENEFITS

- Obtain highly accurate pressure readings, ensuring precise monitoring of water and wastewater systems
- Rugged and durable construction withstand various challenging environments
- 4 to 20 mA with HART protocol output
- Easy installation and integration

Note: When ordering units without the Local Operator Interface, please provide the appropriate set points for both 4 mA and 20 mA.

SPECIFICATIONS

ACCURACY	±0.075% of Span
OUTPUT	4 to 20 mA with HART® Protocol
ISOLATION DIAPHRAGM	316L SS
PROCESS CONNECTION	1/2" NPT(F)
ELECTRICAL CONNECTION	1/2" NPT(F) Conduit
POWER	10.5 to 36 VDC
TURNDOWN RATIO	50:1
HOUSING	NEMA 4X, Polyurethane Painted Aluminum

C&M PART #	MFG PART #	PRESSURE RANGE (PSI)	DISPLAY	LOCAL OPERATOR INTERFACE (DISPLAY & PUSHBUTTONS)
4016120205	2088GIS22A1	-14.7 to 30	No	No
4016120208	2088G2S22A1	-14.7 to 150	No	No
4016120105	2088GIS22A1M5	-14.7 to 30	Yes	No
4016120108	2088G2S22A1M5	-14.7 to 150	Yes	No
4016120305	2088GIS22A1M4	-14.7 to 30	Yes	Yes
401612020F	2088G2S22A1M4	-14.7 to 150	Yes	Yes

REPLACEMENT PARTS & ACCESSORIES

C&M PART #	MFG PART #	DESCRIPTION
401617	03031-0189-0004	B4 Mounting Bracket for 2088 Pressure Transmitters, 2" Pipe/Panel Mount

Rosemount® 2051 Pressure Transmitters



The 2051 Gauge and Differential Pressure Transmitters are engineered specifically for the demands of the municipal sector and utilizes advanced sensing technology to provide accurate pressure measurements even in the most challenging conditions. This enables you to monitor pressure changes with confidence, ensuring optimal performance and minimizing downtime.

These pressure transmitters feature a user-friendly interface, simplifying installation and configuration. With intuitive menus and guided setup procedures, you can quickly get your transmitter up and running, saving time and effort. Advanced diagnostic capabilities of the transmitters provide real-time information on process conditions, allowing you to quickly identify potential issues and take corrective actions. Models with Local Operator Interface (LOI) feature a digital display and push buttons that allow you to set up or re-range your transmitter quickly.

FEATURES & BENEFITS

- Precise and reliable pressure measurement
- Get the information in real time to quickly fix any issues
- Robust construction withstands the rigors of the municipal environment
- LOI (Local Operator Interface) feature pushbuttons for easy field configuration
- View pressure and diagnostic information on the LCD

SPECIFICATIONS

ACCURACY	±0.065% of Span
TURNDOWN RATIO	100:1
OUTPUT	4 to 20 mA, HART® Protocol
SENSING ELEMENT	316L SS
PRESSURE CONNECTION	1/4" NPT(F)
POWER	10.5 to 42.4 VDC
ENCLOSURE	NEMA 4X, Polyurethane Coated Aluminum

C&M PART #	MFG PART #	RANGE	DISPLAY	LOCAL OPERATOR INTERFACE (DISPLAY & PUSHBUTTONS)
A GAUGE PRESSURE TRANSMITTERS				
401615020G	2051TG1A2B21A	-14.7 to 30 PSI	No	No
401615020F	2051TG2A2B21A	-14.7 to 150 PSI	No	No
401615020H	2051TG3A2B21A	-14.7 to 800 PSI	No	No
401615030G	2051TG1A2B21AM4	-14.7 to 30 PSI	Yes	Yes
401615030F	2051TG2A2B21AM4	-14.7 to 150 PSI	Yes	Yes
401615030H	2051TG3A2B21AM4	-14.7 to 800 PSI	Yes	Yes
B DIFFERENTIAL PRESSURE TRANSMITTERS				
401616020I	2051CD1A22A1A	-25 to 25" H ₂ O	No	No
401616020J	2051CD2A22A1A	-250 to 250" H ₂ O	No	No
401616020E	2051CD3A22A1A	-1000 to 1000" H ₂ O	No	No
401616020K	2051CD4A22A1A	-300 to 300 PSI	No	No
401616030I	2051CD1A22A1AM4	-25 to 25" H ₂ O	Yes	Yes
401616030J	2051CD2A22A1AM4	-250 to 250" H ₂ O	Yes	Yes
401616030E	2051CD3A22A1AM4	-1000 to 1000" H ₂ O	Yes	Yes
401616030K	2051CD4A22A1AM4	-300 to 300 PSI	Yes	Yes

REPLACEMENT PARTS & ACCESSORIES

C&M PART #	MFG PART #	DESCRIPTION
401617	03031-0189-0004	B4 Mounting Bracket for Gauge Pressure Transmitters, 2" Pipe/Panel Mount
401618	03031-0189-0003	B4 Mounting Bracket for Differential Pressure Transmitters, 2" Pipe/Panel Mount
401619	305RC32B11	Rosemount 3-Valve Manifold for Differential Pressure Transmitters
401620	03031-1300-0002	Rosemount Flange Adapters, Pair for Differential Pressure Transmitter (includes O-Rings & Bolts)

HOW TO ORDER



ONLINE

supply.coreandmain.com



TELEPHONE

1-888-885-2673



EMAIL

support.supply@coreandmain.com

HOURS OF OPERATION: M-F; 6 A.M. to 7 P.M. CST



**Rosemount® 3051T
In-Line Pressure Transmitters**



The 3051T Pressure Transmitters are the perfect solution for water and wastewater municipal customers seeking accurate and reliable gauge pressure measurement. The compact, in-line design allows the transmitters to be connected directly to a process for quick, easy and cost-effective installation. Designed with the specific needs of the industry in mind, these transmitters empower you to optimize your operations, improve efficiency and ensure the highest level of performance in your critical processes.

The 3051T pressure transmitters deliver precise and reliable pressure measurements, allowing you to monitor and control your water and wastewater systems with confidence. With its advanced sensing technology, it provides accurate readings even in challenging conditions, ensuring you have real-time data you can rely on.

FEATURES & BENEFITS

- Robust and durable design withstand the demanding nature of the municipal environment
- Superior response time when compared to other Smart pressure transmitters
- Engineered for 10-year installed stability

SPECIFICATIONS

ACCURACY	±0.04% of span
OUTPUT	4 to 20 mA with HART® Protocol
SENSING ELEMENT MATERIAL	Silicone Sensor Fill Fluid with 316L SS Diaphragm
WETTED MATERIALS	316L SS
PROCESS CONNECTION	1/2" NPT(F)
POWER	9 to 32 VDC
ENCLOSURE	Aluminum, Polyurethane Coated
TURNDOWN RATIO	150:1

C&M PART #	MFG PART #	RANGE	DISPLAY	TYPE
401621020G	3051TG1A2B21A	-14.7 to 30 PSI	No	In-Line
401621020F	3051TG2A2B21A	-14.7 to 150 PSI	No	In-Line
401621020H	3051TG3A2B21A	-14.7 to 800 PSI	No	In-Line
401621010G	3051TG1A2B21AM5	-14.7 to 30 PSI	Yes	In-Line
401621010F	3051TG2A2B21AM5	-14.7 to 150 PSI	Yes	In-Line
401621010H	3051TG3A2B21AM5	-14.7 to 800 PSI	Yes	In-Line

REPLACEMENT PARTS & ACCESSORIES

C&M PART #	MFG PART #	DESCRIPTION
401617	03031-0189-0004	B4 Mounting Bracket for 3051T Pressure Transmitters, 2" Pipe/Panel Mount

Rosemount 3051C Pressure Transmitters



The 3051C Smart Pressure Transmitters combine advanced technology with the versatile Coplanar™ process connection to set a new standard in pressure measurement performance. They are designed to work in demanding environments and excel in measurement of differential, gauge, or absolute pressure.

These transmitters provide superior response time and are accurate to ±0.04%, resulting in total operating performance of ±0.15% made possible due to its use of advanced capacitance sensor technology. The high accuracy and stability of the 3051C equates to reduced variability, lower operating and maintenance costs and improved plant safety.

FEATURES & BENEFITS

- Coplanar process connection provides versatility
- Reduced variability due to its high-accuracy rate
- Installed five-year stability of 0.125%
- Enables integrated pressure, flow, and level solutions with application specific configurations

SPECIFICATIONS

ACCURACY	±0.04% of span
OUTPUT	4 to 20 mA with HART® Protocol
SENSING ELEMENT MATERIAL	Silicone Sensor Fill Fluid with 316L SS Diaphragm
WETTED MATERIALS	316L SS
PROCESS CONNECTION	1/4" NPT(F)
POWER	9 to 32 VDC
ENCLOSURE	Aluminum, Polyurethane Coated
TURNDOWN RATIO	150:1

C&M PART #	MFG PART #	RANGE	LCD DISPLAY	TRANSMITTER FLANGE TYPE
401622020I	3051CD1A22A1A	-25 to 25 H ₂ O	No	Coplanar
401622020J	3051CD2A22A1A	-250 to 250 H ₂ O	No	Coplanar
401622020E	3051CD3A22A1A	-1000 to 1000 H ₂ O	No	Coplanar
401622020K	3051CD4A22A1A	-300 to 300 PSI	No	Coplanar
401622010I	3051CD1A22A1AM5	-25 to 25 H ₂ O	Yes	Coplanar
401622010J	3051CD2A22A1AM5	-250 to 250 H ₂ O	Yes	Coplanar
401622010E	3051CD3A22A1AM5	-1000 to 1000 H ₂ O	Yes	Coplanar
401622010K	3051CD4A22A1AM5	-300 to 300 PSI	Yes	Coplanar

REPLACEMENT PARTS & ACCESSORIES

C&M PART #	MFG PART #	DESCRIPTION
401618	03031-0189-0003	B4 Mounting Bracket for 3051C Differential Pressure Transmitters, 2" Pipe/Panel Mount

ENO Scientific Well Watch 670 Water Level Meter

Get real-time, on-site groundwater levels using the Well Watch 670 Water Level Meter. This semi-permanent sonic water level indicator is designed to meet the long-term monitoring needs in municipal and environmental applications. The meter utilizes low frequency sound waves to provide continuously updated, accurate levels from on top of the well. The sound waves can travel around 90-degree corners or coils of pipe allowing the freedom to install the Well Watch 670 meter at the most convenient location for that site. Meter measures levels down to 7000 ft, on casings up to 8" diameter.

Use the display with keypad to easily control internal settings and view real-time data. A built-in datalogger logs up to 25 million time/date stamped data points—perfect for monitoring and trending water level and usage. Select from multiple output options to suit your application.

FEATURES & BENEFITS

- Complete data with easy acquisition
- No proprietary software or monthly fees
- Real-time well level measurements (static, drawdown and recovery)
- Enables well management and control capabilities.
- Helps comply with state and local usage regulations
- Protect the investment in well and pump equipment
- Built-in alarm capability in case of emergencies

INCLUDES

1/2", 3/4", 1" diameter nozzles, USB cable and AC power supply



SPECIFICATIONS

RANGE (ft)	10 to 7000
ACCURACY (ft)	±0.1
RESOLUTION (ft)	0.05
UPDATE TIME	-1 sec @ 500 ft
POWER	6.5 to 12 VDC at 80 mA Max (Do Not Exceed 16 V)
REAL TIME CLOCK	Li-Ion 3 V Battery CR2032
TEMPERATURE	-10 to 110°F (-20 to 45°C)
HUMIDITY	10 to 90% Noncondensing
DISPLAY	2 x 16 Character LCD
INPUT	RS232, RS485 (Modbus), Built-in Wireless Link for Use with 310 Remote Display, USB
OUTPUT	Analog: 4 to 20 mA and 0 to 5 VDC Alarm: 5 V @ 15 mA max

C&M PART #	MFG PART #	DESCRIPTION
111955	670	Well Watch 670 Water Level Indicator with Integral Display

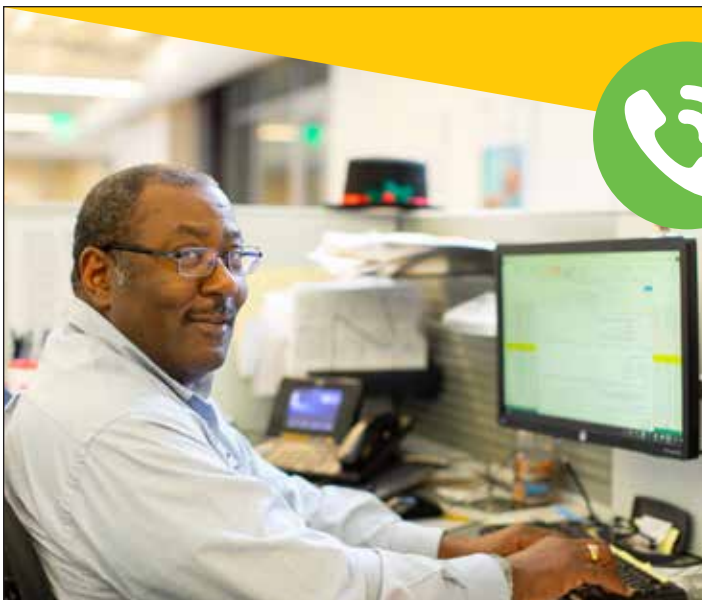

**TALK TO AN
EXPERT TODAY!**

Need application advice or help to locate a part? Contact our technical specialists, they are here to help!

1-888-885-2673

ENO Scientific Well Watch 700 Water Level Indicator



The Well Watch 700 Water Level Indicator is the world's first and only commercial grade sonic water level sensor designed for municipal, agricultural, and oil/gas applications. This Patented system monitors water levels by sending a powerful acoustic pulse into the casing then calculating time/distance on the reflection. Externally mounted sensor allows use on wells containing caustic water, oil or pressurized gas. Installation is simple and there is no yearly maintenance or calibration, eliminating the expensive initial and recurring fees common with other measurement technologies.

The Well Watch 700 Water Level Indicator not only logs and displays water levels but can also take inputs from pulsed flowmeters. It also includes two independently programmable relay contacts available for pump control or remote alarms. Data is calculated internally so there is no requirement for wi-fi accessibility or proprietary software.

FEATURES & BENEFITS

- Real-time well level measurements (static, drawdown and recovery)
- Complete data with easy acquisition
- Enables well management and control capabilities
- Protect the investment in well and pump equipment
- Built-in alarm capability in case of emergencies
- No proprietary software or monthly fees
- Helps comply with state and local usage regulations

INCLUDES

Well Watch 700 (710 Controller with 730 Probe)

SPECIFICATIONS (710 CONTROLLER)

RANGE (ft)	15 to 7000
ACCURACY (ft)	±0.1
RESOLUTION (ft)	0.05
AUTOMATIC LOGGING RATES	1 sec to 1 Day per Sample
EXTENDED MEMORY	2GB Nonvolatile Flash Memory for 25 Million Data Point
INTERNAL POWER	(6) AA Alkaline Batteries
EXTERNAL POWER	12 to 36 VDC at 300 mA Max (with All Options Enabled)
REAL TIME CLOCK	Li-Ion 3 V Battery CR2032
TEMPERATURE	-20 to 175 °F (-25 to 80 °C)
HUMIDITY	5 to 95% Noncondensing
DISPLAY	2 x 16 Character LCD
COMMUNICATION	RS232 Serial Port/RS485 Serial Modbus Port/SDI12 Serial Port, Ethernet (Modbus TCP, Webserver)
INPUT	Pulsed Flowmeter
ALARM OUTPUT	Isolated Relay Contact 250 V AC 0.25 A (30 VDC 2 A) Max
PUMP CONTROL OUTPUT	Isolated Relay Contact 250 V AC 0.25 A (30 VDC 2 A) Max
ANALOG OUTPUTS	Independent 4 to 20 mA and 0 to 5 VDC

SPECIFICATIONS (730 CONTROLLER)

MATERIAL	Type 304 Stainless Steel Weatherproof Housing
WELL PRESSURE (psi)	Up to 100
WELL ACCESS PORT	2" FPT Connection
TEMPERATURE	-20 to 175 °F (-25 to 80 °C)
HUMIDITY	5 to 95% Noncondensing
COMMUNICATIONS	4-Wire to 710 Controller
DIMENSIONS (L x W x H)	10.15" x 4.4" x 4.4"
WEIGHT (lbs)	10

C&M PART #	MFG PART #	DESCRIPTION
111956	700	Well Watch 700 Water Level Indicator



Helpful Tip: Municipal Well Monitoring

Municipalities water systems come in many sizes, some serving a few hundred and some serving thousands and more. Eno Scientific's products have helped to solve groundwater management issues throughout the United States. Sonic sensors are an easy external retrofit to any new or existing well.

Many of the larger systems have well sites that incorporate a large diameter well that is equipped with a top mount turbine pump, flow sensors and a storage tank. Typically there will also be a SCADA system that gathers data from all of the installed equipment and communicates that back to a central hub where the system managers can review the collected data and control equipment settings. For this purpose, Eno Scientific specifically designed the Well Watch 700 with the ability to monitor levels in large diameter production wells with a variety of well designs and access ports.



ENO Scientific Well Sounder 2010 Pro Water Level Meters



Use this portable, handheld Well Sounder 2010 Pro Water Level Meter to measure static water level in wells. The meter uses sound waves to measure the distance from the top of the well to the water level, eliminating the need to lower anything into the well, preventing well contamination and clean up. Simply place the probe into a well cap opening and turn the unit on, within seconds the unit will display the static water level.

The meter can also perform unsupervised drawdown testing and log the information for easy download. Set it to take measurements at intervals between 1 to 60 minutes, power save function puts the unit to sleep conserving battery life. Once testing is completed, download logged information for analysis using the USB port.

The WS2100 Flow Meter Kit combines all the instrumentation needed to perform a complete well drawdown test. The kit includes the Well Sounder 2010 PRO water level meter with its built-in data logger and USB computer connectivity and the new WS131 Flowmeter with a variety of housing sizes.

The WS131 Flowmeter is designed to measure water flow for monitoring well drawdown and usage. It uses a modular design consisting of a PVC housing and an electronic sensor module that easily attaches to the housing using a hand tightened ring nut. With the sensor in place, electrical pulses are generated as water moves past the paddle wheel which is interpreted as water volume by the Well Sounder 2010 PRO. When the test is complete, simply remove the sensor and replaced it with a plug.

FEATURES & BENEFITS

- Measures static water levels down to 4000 ft
- Stores up to 25 million time/date stamped log points
- USB port for data download, no special software necessary
- Powered by 6 AA batteries
- Calculates drawdown and recovery rates
- Protect the investment in well and pump equipment
- Measures flow rates from 0.86 to 170 GPM

INCLUDES

111952—Well Sounder 2010 PRO meter, probe, US groundwater temperature map, USB cable, carrying case, user manual, quick start guide and 1 year warranty

111953—Well Sounder 2010 PRO meter, WS 131 flowmeter, 1, 1.5 & 2" housings, accessory splitter and three plugs with retaining nuts

SPECIFICATIONS

RANGE (ft)	9 to 4000
ACCURACY (ft)	±0.1
RESOLUTION (ft)	0.05
UPDATE TIME	- 1 sec @ 500 ft, - 4 sec @ 2000 ft
AUTOMATIC LOGGING RATES	1 sec to 60 min per Sample
MEMORY	Nonvolatile Flash Memory for 13,000 Data Points
EXTENDED MEMORY	2GB Nonvolatile Flash Memory for 25 Million Data Points
INTERNAL POWER	(6) AA Alkaline Batteries
EXTERNAL (OPTIONAL)	6.5 to 12 VDC at 80 mA Max (Do Not Exceed 16 V)
REAL TIME CLOCK	Li-Ion 3V Battery CR2032
TEMPERATURE	-10 to 110° F (-20 to 45° C)
HUMIDITY	10 to 90% Noncondensing
DISPLAY	2 x 16 Character LCD
BATTERY LIFE	Up to 80 Hours Continuous, Up to 21 Days in Power Save Mode
COMMUNICATION	9-Pin RS232 Serial Port, Bidirectional, USB Port
OUTPUTS (OPTIONAL)	4 to 20 mA and 0 to 5 VDC with Available Adapters

C&M PART #	MFG PART #	DESCRIPTION
111952	2010P	Well Sounder 2010 PRO Water Level Meter and Probe with Case
111953	2100	WS2100 Flow Meter Kit With 2010 PRO Water Level Meter & WS131 Flowmeter

REPLACEMENT PARTS & ACCESSORIES

C&M PART #	MFG PART #	DESCRIPTION
11195730	5401	WS131 Flow Meter with 1" Housing
11195740	5403	WS131 Flow Meter with 1-1/2" Housing
11195750	5404	WS131 Flow Meter with 2" Housing
11195787	5406	WS131 Flow Meter with 3" Housing
111957C1	5407	WS131 Flow Meter with 4" Housing
111957I2	5408	WS131 Flow Meter with 6" Housing
111958	5220	Accessory Splitter



Solinst 102 Water Level Meters with P10 Probe



The Model 102 Water Level Meters are designed to measure groundwater levels, especially in small diameter tubes or where a flexible assembly is required to get past an in-well pump. The included rugged P10 stainless steel (SS) probe features 10-segmented flexible SS weights for easy well access and keeps cable hanging straight in monitoring wells. When the probe contacts water, the LED light and buzzer are activated. Read the measurement on the cable at the top of the well casing or bore hole to determine the water level.

Each meter features a convenient carrying handle and stand-alone design, making it ideal for field use. A sensitivity control allows the buzzer to be scaled back or turned off while in cascading water to ensure a clear signal in both high and low conductivity conditions. The cable reels smoothly and remains flexible.

FEATURES & BENEFITS

- Includes P10 probe with flexible SS weights
- Adjust sensitivity to suit your application
- Clearly-marked cable at 1/100 ft intervals are laser marked to the cable
- Flexible, abrasion-resistant cable
- Easy access battery drawer and well-designed brake assembly
- Ergonomically designed to be comfortable in use

SPECIFICATIONS

WETTED MATERIALS	PVDF, Santoprene®, Delrin®, Viton®, 316 SS
PROBE PRESSURE RATING	Submersible to 1000 ft
PROBE WEIGHT (oz)	6.14
PROBE SIZE	3/8" Dia x 2.75" L
REEL IP RATING	IP64 (dust & splash proof)
POWER	One 9 V Battery

C&M PART #	MFG PART #	CABLE LENGTH (ft)
11142810	114861	80
111428DG	114867	100
111428EM	114870	200
111428EQ	114873	300
11142811	114876	500
11142812	114879	750
11142813	114882	1000

Solinst 102M Mini Water Level Meter with P4 Probe



The Model 102M Mini Water Level Meters are designed to measure groundwater levels and are ideal for shallow applications and for accessing very narrow diameters. The included durable P4 probe has no weights and weighs 10 g. When the probe contacts water, the LED light and buzzer are activated. Read the measurement on the cable at the top of the well casing or bore hole to determine the water level.

Each meter features a convenient carrying handle and stand-alone design, making it ideal for field use. A sensitivity control allows the buzzer to be scaled back or turned off while in cascading water and ensures a clear signal in both high and low conductivity conditions. The cable reels smoothly and remains flexible.

FEATURES & BENEFITS

- Includes P4 probe with no weights
- Adjust sensitivity to suit your application
- Clearly-marked cable at 1/100 ft intervals are laser marked to the cable
- Flexible, abrasion-resistant cable
- Easy access battery drawer and well-designed brake assembly
- Ergonomically designed to be comfortable in use

SPECIFICATIONS

WETTED MATERIALS	PVDF, Santoprene®, Delrin®, Viton®, 316 SS
PROBE PRESSURE RATING	Submersible to 1000 ft
PROBE WEIGHT (oz)	0.35
PROBE SIZE	0.157" Dia x 1.5" L
REEL IP RATING	IP64 (dust & splash proof)
POWER	One 9 V Battery

C&M PART #	MFG PART #	CABLE LENGTH (ft)
11144210	114911	80
111442DG	114910	100
111442EM	114912	200
111442EQ	114913	300

Solinst 101 Water Level Meters with P7 Probe



Use Model 101 Flat Tape Water Level Meter to measure the depth to water in wells, boreholes, standpipes and tanks. These hand-operated meters are sturdy, easy to use and read accurately to 1/100 ft. Each meter features a convenient carrying handle, stand-alone design and sturdy probe holder, making it ideal for field use.

The pressure-proof stainless steel probe (P7) and laser marked non-stretch PDVF tape ensure accurate measurements. When the probe contacts the water, an insulating gap between electrodes complete the circuit, activating a buzzer and a light. The water level is read from the tape at the top of the well or borehole. The reels are equipped with an on/off sensitivity switch, light, buzzer, battery test button, brake and a tape guide stored on the frame.

FEATURES & BENEFITS

- Laser marked, 3/8" wide, PVDF flat tape remains flexible and hangs straight in the well
- Heat embossed marking each 1/100 ft allow accurate readings
- Dog-bone design on the tape reduces adherence to wet surfaces
- The P7 probe weighs only 4.5 oz and offers almost zero displacement
- Rugged, corrosion-proof components

SPECIFICATIONS

WETTED MATERIALS	PVDF, Santoprene®, Delrin®, Viton®, 316 SS
PROBE PRESSURE RATING	Submersible to 1000 ft
PROBE WEIGHT (oz)	4.5
PROBE SIZE	5/8" Dia x 5.38" L
REEL IP RATING	IP64 (dust & splash proof)
POWER	9 V Battery

C&M PART #	MFG PART #	CABLE LENGTH (ft)
111450DG	110146	100
111450EM	110185	200
111450EQ	110186	300
11145011	110187	500
11145012	110188	750
11145013	110189	1000

Solinst 101D Water Level Draw Down Meters with P7 Probe



Measure the depth of water as well as monitor falling hydraulic head with Model 101D Water Level DrawDown Meter. Use the water level mode to accurately measure the depth to water in wells, boreholes, standpipes, and tanks. The meter uses a laser marked, corrosion- and chemical-resistant flat tape that can read accurately to 1/100 ft. Use the drawdown mode if you need to know when levels in a well are dropping. The drawdown function monitors falling hydraulic head during low flow sampling, pumping and other aquifer/well tests. It also ensures a pump's intake remains submerged during purging or well development.

In water level mode, when the probe contacts the water, an insulating gap between electrodes complete the circuit, activating a buzzer and a light. The depth to water is then read off the tape. In drawdown mode, the circuit is reversed—the buzzer and light are triggered when the probe is in air. The battery test button can check the circuit in both water level and drawdown modes. The on/off sensitivity control allows the buzzer to be turned down in cascading water and ensures a clear signal in high and low conductivity conditions.

FEATURES & BENEFITS

- Both static water levels and drawdown modes in one meter
- One convenient toggle makes it easy to switch between the two functions
- 3/8" wide tape with heat embossed marking at each 1/100 ft allows for accurate readings
- The P7 probe weighs only 4.5 oz and offers almost zero displacement
- Rugged, corrosion-proof components

SPECIFICATIONS

WETTED MATERIALS	PVDF, Santoprene®, Delrin®, Viton®, 316 SS
PROBE PRESSURE RATING	Submersible to 1000 ft
PROBE WEIGHT (oz)	4.5
PROBE SIZE	5/8" Dia x 5.38" L
REEL IP RATING	IP64 (dust & splash proof)
POWER	9 V Battery

C&M PART #	MFG PART #	CABLE LENGTH (ft)
111468DG	114115	100
111468EM	114116	200
111468EQ	114117	300
11146811	114118	500
11146812	114119	750
11146813	114120	1000

Solinst 105 Well Casing & Depth Indicators

Simple and durable, Model 105 Well Casing & Depth Indicators are easy to use when detecting metal well casing or measuring total well depth. Easily conduct both functions without having to switch out the probe; a dual-function stainless steel probe is connected to clearly marked flat tape, fitted on a well-balanced reel.



Solinst

Use the indicator to determine where metal casing starts and ends in new or existing well constructions, detecting cracks in well casing, hydrofracturing, and installing packers or other downhole instruments. The probe has a strong internal magnetic assembly to detect well casing. When the probe is adjacent to magnetic metal (e.g. steel) a circuit is completed activating the buzzer and light (quick intermittent beeps and flashing red light). When the probe is no longer next to the casing, the signals stop. Depths are read from the tape at surface.

Measure the total depth using the plunger at the bottom of the probe. The light and buzzer activate when the plunger reaches the bottom of a well and is pushed into the probe body completing a magnetic circuit (slow intermittent beeps and flashing red light). The depth is read from the tape. The convenient battery test button checks the main circuitry to determine when the battery needs replacing. For easy-access, the battery is housed in a drawer in the front of the faceplate.

FEATURES & BENEFITS

- Dual-function probe—use for well casing depth indication and total well depth measurement
- Uses non-stretch, accurate laser marked flat tape
- Thick dog bone design prevents adherence to wet surfaces and allows the tape to hang straight
- 3/8" wide tape with heat embossed marking at each 1/100 ft allows for accurate readings

SPECIFICATIONS

WETTED MATERIALS	PVDF, Santoprene®, Delrin®, Viton®, 316 SS
PROBE WEIGHT (oz)	10
PROBE SIZE	7/8" Dia x 7.6" L
REEL IP RATING	IP64 (dust & splash proof)
POWER:	9 V Battery

C&M PART #	MFG PART #	CABLE LENGTH (ft)
111474DG	114450	100
111474EM	114451	200
111474EQ	114452	300
11147411	114453	500
11147412	114455	750
11147413	114456	1000
11147414	114457	1250
11147415	114458	1650
11147416	114459	2000

Solinst Parts & Accessories



111465

Solinst

C&M PART #	MFG PART #	DESCRIPTION
A REPLACEMENT P10 PROBE/CABLE ASSEMBLY		
111466	114848	P10 (3/8") SS Probe with 10-ft L Marked Cable
11143510	112288	P10 (3/8") SS Probe with Mini, 80-ft L Marked Cable
111435DG	112295	P10 (3/8") SS Probe with 100-ft L Marked Cable
111435EM	112296	P10 (3/8") SS Probe with 200-ft L Marked Cable
111435EQ	112297	P10 (3/8") SS Probe with 300-ft L Marked Cable
11143511	112298	P10 (3/8") SS Probe with 500-ft L Marked Cable
11143512	112299	P10 (3/8") SS Probe with 750-ft L Marked Cable
11143513	112300	P10 (3/8") SS Probe with 1000-ft L Marked Cable
B REPLACEMENT P7 PROBE/CABLE ASSEMBLY		
111456DG	110213	P7 (5/8") SS Probe with 100-ft L Marked Cable
111456EM	110214	P7 (5/8") SS Probe with 200-ft L Marked Cable
111456EQ	110215	P7 (5/8") SS Probe with 300-ft L Marked Cable
11145611	110216	P7 (5/8") SS Probe with 500-ft L Marked Cable
11145612	110217	P7 (5/8") SS Probe with 750-ft L Marked Cable
11145613	110218	P7 (5/8") SS Probe with 1000-ft L Marked Cable
C REPLACEMENT P4 PROBE/CABLE ASSEMBLY		
111467	114908	P4 (0.157") SS Probe with 10-ft L Marked Cable
11144210	114911	P4 (0.157") SS Probe with 80-ft L Marked Cable
111442DG	114910	P4 (0.157") SS Probe with 100-ft L Marked Cable
111442EM	114912	P4 (0.157") SS Probe with 200-ft L Marked Cable
111442EQ	114913	P4 (0.157") SS Probe with 300-ft L Marked Cable

REPLACEMENT PARTS & ACCESSORIES

C&M PART #	MFG PART #	DESCRIPTION
111462	111058	Cable Splice Assembly for Model 102 Water Level Meters, Crimp Style
111463	110277	Tape Splice Kit Crimped Style
111464	106253	Carrying Case For Mini (Model 102, 80') Water Level Meter
111465	102974	Small Reel Bag Fits 50-400 Foot Reels

Lighting



TABLE OF CONTENTS

Area Lights	244
Flashlights	244-245
Headlamps	246-247
Lanterns	247
Lighting Part & Accessories	248
Penlights	248-249
Right Angle Lights	249

Pelican™ Remote Area Lighting Systems



These rugged remote area lighting systems provide a complete lighting solution for any commercial, industrial, and professional applications. Heavy-duty construction and easy portability make these lights ideal for first responders, industrial and aerospace applications.

SPECIFICATIONS

C&M PART #	107259	107264	107263	107262	107260	107261
COLOR	Hi-Viz Yellow	Yellow	Yellow	Yellow	Yellow	
POWER	Battery	Battery	Battery	Battery	Battery/Electric	
RUN TIME (HOURS)	Up to 10	Up to 15	Up to 24	Up to 28	Selective	
LUMENS	1600	3000	6000	4000	6000 (2)	
LIGHT HEAD HEIGHT	31.5"	32.3"	72.0"	23.8"	79.50"	
CORD LENGTH	12.6"	13.8"	N/A	N/A	13.78"	
WEIGHT (lbs)	16.0	22.7	32.0	27.5	61.0	64.0
SAFETY CERTIFIED	Yes	No	No	No	No	

C&M PART #	MFG PART #	DESCRIPTION
107259	094550-0000-245	9455 Safety Certified Remote Area Light; Class I Division 1, ATEX Zone 0 and IECEx
107264	094300-0001-245	9430 Remote Area Lighting System Gen 3
107263	094900-0000-245	9490 Remote Area Light with Extra Tall Light Head, Quick-Release Battery
107262	094800-0000-245	9480 Remote Area Light, Quick-Release Battery
107260	094600-0002-245	9460 Remote Area Light, Dual Light Heads
107261	094600-0012-245	9460M Remote Area Light with Mobility Wheel Kit, Dual Light Heads

Pelican™ High-Performance Tactical Flashlights



Use these high-performance flashlights for tactical or emergency situations. Flashlights are compact and lightweight yet deliver the power and reliability needed by first responders, military personnel, and outdoor enthusiasts.

FEATURES & BENEFITS

- Selectable light intensity
- Durable impact-resistant aluminum body
- Waterproof housing
- Selectable beam distance and focus



INCLUDES

- 107227 - (2) Batteries
- 107228 - (1) Battery
- 107229 - Wand, Holster Combo, and (1) Battery
- 107330 - (2) Batteries

SPECIFICATIONS

C&M PART #	107227	107228	107229	107230
COLOR	Black			
BATTERY TYPE	Alkaline	Lithium-Ion		
BATTERY SIZE	AA (2)	18650	3V CR123 (2)	
RECHARGEABLE	No	Yes		
CHARGE TIME (Hrs)	N/A	5	N/A	
RUN TIME (Hrs)	Up to 13	Up to 29	Up to 13	
LUMENS	375	944	774	
LIGHT TYPE	LED			
LENGTH	6.2"		5.1"	
WEIGHT (oz)	5.4		5.6	
SETTINGS	High/Low/Strobe	High/Medium/Low/Strobe		
IP RATING	IPX8		IPX7	

C&M PART #	MFG PART #	DESCRIPTION
107227	023600-0002-110	2360 Tactical Flashlight with Nonslip Textured Body
107228	076000-0000-110	7600 Tactical Flashlight Only
107229	076000-0040-110	7600 Tactical Flashlight with Wand and Holster
107230	070000-0001-110	7000 Compact Tactical Flashlight with Nonslip Textured Body

Pelican™ 3310PL Photoluminescent LED Flashlight

The 3310PL Photoluminescent Flashlight emits a bright glow making it highly visible even in pitch black environments. With a run time of up to 202 hours, it is invaluable in emergency situations.

FEATURES & BENEFITS

- Glow-in-the-dark polycarbonate housing
- Flashing signal/distress mode
- Three Settings—High, Low, and Flashing
- Textured push-button body switch
- White LED emitter

INCLUDES

- (3) AA batteries, lanyard and removable clip



C&M PART #	MFG PART #	COLOR	BULB	LUMENS	BATTERY TYPE	RUN TIME (Hrs)	IP RATING
107250	033100-0102-247	Photoluminescent	LED	378	Alkaline	Up to 202	IPX8

Pelican™ 3315 Safety Rated Flashlight

Safety approved for the most volatile work environments, the 3315 LED Flashlight is one of the most efficient flashlights on the market today. Lightweight and compact flashlight holds three AA batteries that power a single LED for 160 lumens of super bright light.

INCLUDES

- (3) AA batteries, lanyard and removable clip

CERTIFICATIONS

- Class I, Class II, Class III – Division 1 safety certified



C&M PART #	MFG PART #	COLOR	BULB	LUMENS	BATTERY TYPE	RUN TIME (Hrs)	IP RATING
107251	033150-0103-245	Hi-Vis Yellow	LED	160	Alkaline	Up to 19	IP67

Pelican™ 2410 Series StealthLite™ Flashlights

The 2410 Series Safety-Certified Flashlights provide high performance and durability in a compact size—slim enough to fit in a pocket. The LED module produces a true, bright collimated LED beam and can be easily operated even with gloved hands. The EXL body material is corrosion proof and resistant to extreme temperatures; IPX7-rated for waterproof down to 1 m for 30 minutes. Model with photoluminescent shroud features a lens ring that emits a bright glow in the dark making it highly visible even in pitch black environments.

INCLUDES

- (4) AA batteries and lanyard

SPECIFICATIONS

BATTERY TYPE	Alkaline
BATTERY SIZE	(4) AA
COLOR	Safety Yellow
RUN TIME (Hrs)	Up to 6
LIGHT TYPE	LED
LUMENS	183
SETTINGS	On/Off
LENGTH	7"
WEIGHT (oz)	3.7
IP RATING	IPX7



CERTIFICATIONS

- Class I, Class II, Class III – Division 1 safety certified

C&M PART #	MFG PART #	DESCRIPTION
107252	024100-0101-245	Black Shroud
107253	024100-0101-247	Photoluminescent Shroud

Pelican™ 2010 Series SabreLite™ Flashlight

The 2010 Series SabreLite Flashlights combine a traditional task light design with high-performance LED technology and safety certifications. The rugged, lightweight polymer body incorporates a twist on/off lens shroud allowing for easy operation and superior impact resistance.

INCLUDES

- Lanyard and clip

SPECIFICATIONS

BATTERY TYPE	Alkaline
BATTERY SIZE	(3) C-Cell
RUN TIME (Hrs)	Up to 22
LIGHT TYPE	LED
LUMENS	161
SETTINGS	On/Off
LENGTH	8.1"
WEIGHT (oz)	5.4
SAFETY RATING	IPX7



CERTIFICATIONS

- Class I, Class II, Class III – Division 1 safety certified

C&M PART #	MFG PART #	DESCRIPTION
107254	020100-0101-245	Safety Yellow Body with Black Shroud
107255	020100-0101-110	Black Body with Black Shroud
107256	020100-0101-247	Safety Yellow Body with Photoluminescent Shroud

**Pelican™ 2700 Series
High-Performance Headlamps**



2720 Headlamp with Gesture Activation Control—Turn on the light with a wave of a hand. Gloved hands, wet hands or oily hands are not an issue with this headlamp. It features variable light output (from 100 to 10%), dual low level red LED light that preserves night vision, red (S.O.S) signaling beacon light and optical 4x magnification allows for a wide or penetrating beam.

2740 Headlamp with Three LEDs—This compact, reliable headlight is ideal for harsh conditions. It features 3 LEDs, two white and one red. The dual white LEDs produce up to 66 lumens of brilliant white light and red LED helps preserve your night vision. A low-level mode provides an extended run time of 21 hours. Designed with weather-resistant casings for fast and easy battery change.

2750 Bright, Compact Headlamp—This headlamp provides up to 259 lumens of illumination. For nighttime applications, use the night vision friendly red LED. Designed with weather-resistant casings for fast and easy battery change.

2760 Super Bright Headlamp with Downcast—This headlamp that does it all. Tough, lightweight, super bright and loaded with multiple lighting features that include high, medium, low, flashing, downcast, and night vision red LED modes. With all these options you can easily light up distant trails or the map in your hands.

INCLUDES

(3) AAA batteries

SPECIFICATIONS

C&M PART #	107231	107232	107234	107236
BATTERY TYPE	Alkaline			
BATTERY SIZE	(3) AAA			
RUN TIME (Hrs)	Up to 103	Up to 21	Up to 11	
LIGHT TYPE	LED			
LIGHT MODES	Variable/Night Vision/Signaling	High/Low/Flashing	High/Low/Downcast/Flashing	
LUMENS	200	66	259	289
SWITCH TYPE	Gesture Activation Control	Push Button		
LENGTH	2.5"	2.25"		
WEIGHT (oz)	2.6	2	2.1	
IP RATING	IPX4			

C&M PART #	MFG PART #	DESCRIPTION
107231	027200-0101-110	2720 Headlamp with Gesture Activation Control
107232	027400-0101-110	2740 Headlamp with Three LEDs
107234	027500-0102-110	2750 Bright, Compact Headlamp
107236	027600-0102-110	2760 Super Bright Headlamp with Downcast

**Pelican™ 2700 Series
Safety Certified Headlamps**



These Safety Certified Headlamps are Class I Division 1 approved for use in hazardous environments. The ultra-compact and lightweight headlamps feature either a single LED or three LEDs to produce powerful illumination.

FEATURES & BENEFITS

- Hands-free design
- High visibility yellow headlamp
- Comfortable cloth strap
- Built Pelican tough



INCLUDES

Batteries

SPECIFICATIONS

C&M PART #	107233	107235	107237	107239
BATTERY TYPE	Alkaline			
BATTERY SIZE	(3) AAA			(4) AA
RUN TIME (Hrs)	Up to 40	Up to 16	Up to 14	Up to 98
LIGHT TYPE	3 LEDs	1 LED	3 LEDs	2 White/1 Red LEDs
LIGHT MODES	High/Low/Flashing		High/Low/Downcast/Flashing	High/Medium/Low/Downcast/Spot/Flashing
LUMENS	33	118	155	215
SWITCH TYPE	Push Button			Rotary/Push Button
LENGTH	2.25"			3"
WEIGHT (oz)	2	2.1		6.6
IP RATING	IP54			

CERTIFICATIONS

- Class I, Division 1 safety certified

C&M PART #	MFG PART #	DESCRIPTION
107233	027450-0103-245	2745 Safety Certified Headlamp
107235	027550-0103-245	2755 Safety Certified Headlamp
107237	027650-0103-245	2765 Safety Certified Headlamp
107239	027850-0000-245	2785 Safety Certified Headlamp

Pelican™ 9050 High-Performance Lantern Light

Select between Li-ion, AA alkaline or AA NiMH to operate the light when using the 9050 High-Performance Lantern Light. This flexible battery system allows you to maximize runtime, letting you have continuous lighting to get the job done. Select between spot, flood, spot/flood, or flashing modes to find the right beam for your job. The spot/flood light head outputs up to 3369 lumens without the need for diffusers or attachments so you can quickly choose the right beam type for your job.



FEATURES & BENEFITS

- Updated charger base provides quick mounting and dismounting
- Rear taillights with dedicated switch and adjustable colors (green, blue, red)
- Glove friendly switch activation
- Wide base for stability
- Battery status indicator

INCLUDES

Charging chord, shoulder strap and battery pack

C&M PART #	MFG PART #	LUMENS	SETTINGS	CHARGE TIME (Hrs)	RUN TIME (Hrs)	COLOR
107257	090500-0000-110	3369	High/Low/Flashing	5.5	Up to 4	Yellow

Pelican™ 9415 Safety Rated LED Lantern

At just 3 pounds and 588* lumens, the new 9415 LED Lantern packs the power without the weight. Four LEDs, powered by the latest generation NiMH batteries illuminate 314 yards (288* meters). Whether you're on a USAR team or the 3rd shift at a refinery, you'll appreciate the compact size and high output of the new 9415 LED Lantern.

FEATURES & BENEFITS

- High, low and flashing modes
- 4 x White LED emitter array
- Head rotates 120° for versatility
- Temperature resistant ABS body
- Weather and impact resistant
- Battery status indicator

INCLUDES

Shoulder strap, 110 VAC charging adapter and rechargeable battery pack

CERTIFICATION

- Class I, Division 1 safety certified



C&M PART #	MFG PART #	LUMENS	SETTINGS	CHARGE TIME (Hrs)	RUN TIME (Hrs)	COLOR
107258	9415-002-245	588	High/Low/Flashing	15	Up to 11	Hi-Vis Yellow

*Performance data is to FL 1 standards.

Pelican™ 2780R Rechargeable Super Bright Headlamp

The Pelican 2780R provides up to 558 lumens of brilliant light to illuminate everything in front with a beam distance of 127 meters. The downcast LED shines in a wide diffused pattern providing safe pathways, illuminated reading spaces and allowing for nonblinding face to face conversations. Use the easy grip dial to select high/medium/low/downcast/spot/flashing settings. A rear mounted battery pack provides full time battery level indication, charging levels and a rear mounted red LED safety light.

INCLUDES

Three interchangeable covers (black, white, photoluminescent), USB charging cable and (1) lithium-ion rechargeable battery (size 18650)



C&M PART #	MFG PART #	LUMENS	SETTINGS	CHARGE TIME (Hrs)	RUN TIME (Hrs)	COLOR
107238	02780R-0000-110	558	6	6	Up to 7.5	Blue

Pelican™ 2469P Rechargeable NiMH Batteries

These 2469P AA Rechargeable NiMH Batteries are compatible with select Pelican flashlights, has a maximum capacity of 2000 mAh, and an output power of 1.2 V. Compatible with 2350 (Gen 2), 2360 (Gen 5), 2365, 2370 (Gen 2), 2380 (Gen 3), 2410N (Gen 2), 2460 (Gen 2), 2460Z1 (Gen 2), 2490, 3310CC, 3310ELS (Gen 2), 3310PL (Gen 2), 3410, 3410M, 3410MCC, 3660Z1 (Gen 2), 7110 (Gen 1), 7610 (Gen 1), 7620 (Gen 1). Comes in a pack of four.



C&M PART #	MFG PART #	PRODUCT TYPE	BATTERY SIZE	BATTERY TYPE	CAPACITY
107265	2460-304-000	Rechargeable Battery	AA	NiMH	2000 mAh

Pelican™ 2389 Lithium-Ion Rechargeable Battery



The 2389 Lithium-Ion Rechargeable Battery is an 18650 cell that powers select Pelican flashlights and headlamps. Compatible with 2380R, 2780R, 3310R, 3310R-RA, 5050R, 7000 (Gen 1), 7070R, 7600, 7610 (Gen 1), 7620 (Gen 1).

C&M PART #	MFG PART #	PRODUCT TYPE	BATTERY SIZE	BATTERY TYPE	CAPACITY
107266	02380R-3010-001	Rechargeable Battery	18650	Lithium-Ion	3.7 V, 2600 mAh, 9.6 Wh

Pelican™ 2387 Battery Casing

This 2387 Battery Pack Casing is compatible with Pelican 7000, 7600, and 7610 tactical flashlights. It holds two CR123 batteries.



C&M PART #	MFG PART #	DESCRIPTION
107267	02380R-3020-001	Battery Casing

Pelican™ Standard Penlights

Super lightweight and compact, these penlights only weigh around 2 oz and fits nicely in your pocket. Using readily available AAA batteries, these bright LED penlights create a clean white beam.



The 1920 penlight feature on/off/momentary settings and provide a long run time. IPX7-rated housing provides waterproof protection down to 1m deep up to 30 minutes.

The new 1970 is engineered with an aluminum core and ABS over molded plastic to withstand tough work environments. It activates with a click of the tail switch or light pressure for momentary use.

INCLUDES

(2) AAA batteries

C&M PART #	MFG PART #	LUMENS	LIGHT MODES	RUN TIME (Hrs)	RATING	COLOR
107244	019200-0001-110	224	High/Low	Up to 8.75	IPX7	Black
107245	019700-0100-110	139	High	Up to 4.25	IPX4	Black

Pelican™ Safety Certified Penlight

These Safety Certified Penlights are engineered with an aluminum core and ABS over molded plastic to withstand tough work environments.



The new 1975 penlight is the slimmest and brightest safety approved penlight. Weighing less than 2 oz, it is easy to carry around in your pocket. Simply activates with a click of the tail switch or light pressure for momentary use.

The 2315 penlight provides up to 115 lumens and 75 meters of spot beam distance. Clip it to your work vest for fast access; activate with a click of a tail switch, even when using heavy-duty work gloves.

INCLUDES

107246—(2) AAA batteries
107247—(2) AA batteries

CERTIFICATIONS

- Class I, II, III - Division 1 / IECEx ia Safety Certified

C&M PART #	MFG PART #	LUMENS	LIGHT MODES	RUN TIME (Hrs)	RATING	COLOR
107246	019750-0100-245	117	High	Up to 2.25	IP68	Hi-Vis Yellow
107247	023150-0100-245	115	High	Up to 6	IPX8	Hi-Vis Yellow

Pelican™ High-Performance Penlight

The 2310 flashlight outputs up to 350 lumens and 134 meters of beam distance. And, with up to 27 hours of run time, the 2310 flashlight has enough power for three work shifts. Engineered with an aluminum core and ABS over molded plastic, these flashlights are built for rough handling and can survive hard drops. Use the clip to attach to your work vest for fast access.

The new 5000 flashlight features flood to spot technology. Use the flood position to project a wide beam to illuminate your work area, spot beam for a long-distance focused beam. Slim design with tough steel clip mounts to pockets or fits in tight spots for quick access and accessibility.



INCLUDES

107248—(2) AA batteries

107249—(2) AAA batteries

C&M PART #	MFG PART #	LUMENS	LIGHT MODES	RUN TIME (Hrs)	RATING	COLOR
107248	023100-0100-110	350	High/Low	Up to 27	IPX8	Black
107249	050000-0100-110	223	High/Low/ Flashing	Up to 8.25	IPX8	Black

Pelican™ High-Performance Right-Angle Lights

The 3410 & 3410M (magnetic version) Right-Angle Lights are the ultimate compact work lights. Molded from “glow-in-the-dark” photoluminescent material, these lights are easy to find even when they are off. Both models feature a spot and flood LED for close-up as well as distance, so you can have wide area light in the immediate work area and still penetrate darkness hundreds of yards away. Activate to run one or both LEDs with three brightness levels. The articulating head and built-in clip allow the light to be directed wherever it is needed. The 3410M comes with a heavy-duty magnet for mounting on to steel surfaces.



INCLUDES

Security lanyard and (3) AA batteries

SPECIFICATIONS

COLOR	Photoluminescent
POWER	Battery
BATTERY TYPE	Alkaline
BATTERY SIZE	AA
LUMENS	653
LIGHT MODES	High/Medium/Low/Flashing
RUN TIME (Hrs)	Up to 61
RATING	IPX8
LENGTH	7.5"
WEIGHT (OZ)	6.6

C&M PART #	MFG PART #	DESCRIPTION
107240	034100-0102-247	3410 Right-Angle Light
107241	034100-0302-247	3410 Right-Angle Light with Magnet

Pelican™ Safety Certified Right-Angle Lights

The 3415 & 3415M (magnetic version) Right-Angle Lights are certified for use in Class I, II, & III Division 1 hazardous locations. Both models feature a spot and flood LED for close-up as well as distance, so you can have wide area light in the immediate work area and still penetrate darkness hundreds of yards away. Activate to run one or both LEDs with three brightness levels. The articulating head and built-in clip allow the light to be directed wherever it is needed. The full-time battery level indicator ensures you will always know your battery level status. The 3415M comes with a heavy-duty magnet for mounting on to steel surfaces.



INCLUDES

Security lanyard and (3) AA batteries

SPECIFICATIONS

COLOR	Hi-Vis Yellow
POWER	Battery
BATTERY TYPE	Alkaline
BATTERY SIZE	AA
LUMENS	336
LIGHT MODES	High/Flashing
RUN TIME (Hrs)	Up to 14
RATING	IPX8
LENGTH	7.5"
WEIGHT (OZ)	6.6

CERTIFICATIONS

- The Class I, II, & III Division 1

C&M PART #	MFG PART #	DESCRIPTION
107242	034150-0102-245	3415 Safety Certified Right-Angle Light
107243	034150-0302-245	3415 Safety Certified Right-Angle Light with Magnet





MORE WAYS TO SHOP, MORE WAYS TO BUY

from Core & Main

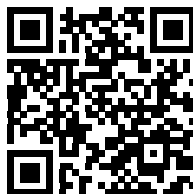

Core & Main has everything you need for the lab, plant, and field. Shop our full range of products in the **Lab** and **Field Essentials** catalogs. Scan the QR code here to order your catalog.

You can also visit supply.coreandmain.com to shop our growing assortment of products tailored to the water & wastewater operator.

Pipe Accessories & Tools



TABLE OF CONTENTS

Flange Packs	252
Lifting	252-253
Tapping	254-255
Cutters & Cutter Wheels	255
Power Cutters	256-257
Diamond Blades	258-259
Valve Operators	259-260

Red Rubber 1/8" Full-Faced Flange Gasket & Bolt Packs



Flange packs are components used in various industries, particularly in piping systems and connections. They are designed to provide a secure and leak-proof connection between pipes or other equipment. Flange packs consist of red-rubber gasket, bolts and nuts.

C&M PART #	MFG PART #	SIZE	INCLUDES
ZINC-PLATED			
1021910150	100-275-00200	2"	1 red rubber gasket, 4 bolts and 4 nuts
1021910170	100-275-00220	2-1/2"	1 red rubber gasket, 4 bolts and 4 nuts
1021910187	100-275-00240	3"	1 red rubber gasket, 4 bolts and 4 nuts
10219101C1	100-275-00260	4"	1 red rubber gasket, 8 bolts and 8 nuts
10219101I2	100-275-00280	6"	1 red rubber gasket, 8 bolts and 8 nuts
10219101L1	100-275-00300	8"	1 red rubber gasket, 8 bolts and 8 nuts
10219101N8	100-275-00320	10"	1 red rubber gasket, 12 bolts and 12 nuts
10219101Q3	100-275-00340	12"	1 red rubber gasket, 12 bolts and 12 nuts
304 STAINLESS STEEL			
1021990350	100-275-01290	2"	1 red rubber gasket, 4 bolts and 4 nuts
1021990370	100-275-01300	2-1/2"	1 red rubber gasket, 4 bolts and 4 nuts
1021990387	100-275-01310	3"	1 red rubber gasket, 4 bolts and 4 nuts
10219903C1	100-275-01320	4"	1 red rubber gasket, 8 bolts and 8 nuts
10219903I2	100-275-01340	6"	1 red rubber gasket, 8 bolts and 8 nuts
10219903L1	100-275-01350	8"	1 red rubber gasket, 8 bolts and 8 nuts
10219903N8	100-275-01360	10"	1 red rubber gasket, 12 bolts and 12 nuts
10219903Q3	100-275-01370	12"	1 red rubber gasket, 12 bolts and 12 nuts

LiftAll Tie-Down Straps



11234601122A



11234604122C

Securely fasten and stabilize cargo, equipment or other loads during transport using Ratchet Tie-Down Straps. Ratchet straps provide a reliable and adjustable means of preventing shifting, movement or damage to items being transported. Polyester webbing offers exceptional durability.

FEATURES & BENEFITS

- Ratchet mechanism creates tension on load
- Adjustability prevents shifting
- Different load ratings and capacities for material hauling
- Safety mechanisms ensure worker safety

C&M PART #	MFG PART #	DESCRIPTION	LOAD/RATCHET TYPE	SIZE
11234601122A	6A103	PE Coated Open Hook Series, 1/Ea	1000 Load Hugger Ratchet Tiedown	1" W x 15 ft L
11234601112A	6A103B	PE Coated Open Hook Series, 16/Pk	1000 Load Hugger Ratchet Tiedown	1" W x 15 ft L
11234602122A	6A105	Hook & Keeper Series	1000 Load Hugger Ratchet Tiedown	1" W x 15 ft L
11234603122C	26422	U-Hook Series	10,000 Load Hugger Polyester Ratchet Tiedown	2" W x 27 ft L
11234604122C	61001	Flat Hook Series	10,000 Load Hugger Polyester Ratchet Tiedown	2" W x 27 ft L

Did you know all Lift-All lifting products are based predominately on Military Specifications?

NEED HELP FINDING AN ITEM?

SHOP CORE & MAIN SUPPLY



Core & Main has access to thousands of products from hundreds of suppliers.

Check out our full assortment of products and suppliers online at supply.coreandmain.com or speak with one of our customer service representatives at **1-888-885-2673**.



LiftAll Slings



Use Lifting Slings to lift and move heavy loads safely and efficiently. They are commonly used in construction, manufacturing, shipping and warehousing. Lifting slings distribute the weight of the load evenly across the surface, reducing stress on the load and ensuring that it is lifted securely.

Chain Slings are made from a series of interlocking metal links. They are highly durable and withstand high temperatures and chemical exposure. Chain slings are often used in applications where the load is extremely heavy or where the sling may encounter sharp edges or abrasive surfaces.

Hydrant Slings, also known as fire hydrant lifting slings, are specifically designed for lifting and moving fire hydrants. The soft, lightweight material will not rust and protect the hydrant finish while lifting.

Web Slings are made from durable synthetic materials such as nylon, polyester or polypropylene. They are lightweight, flexible, and have a wide surface area, which helps prevent damage to delicate or polished surfaces.

Roundslings are made from synthetic materials that form a continuous loop. They are lightweight, flexible, easy to handle, and provide a wide bearing surface that helps protect the load. Roundslings are especially useful for lifting delicate or irregularly shaped loads. They are color-coded to indicate their weight capacity.

Wire Rope Slings are constructed from strands of wire ropes that are twisted together. They are known for their strength and durability, making them suitable for heavy-duty lifting tasks. Wire rope slings are resistant to abrasion, heat and environmental factors—excellent for outdoor and rugged environments.



C&M PART #	MFG PART #	DESCRIPTION
A CHAIN SLINGS		
112419	38SGGW10X10	G100 Chain Sling with Single Welded Grab Hook, 3/8" W x 10 ft L
112420	384OSML8	G100 Mechanical Quad Oblong Sling Hook with Latches, 3/8" W x 8 ft L
B HYDRANT SLINGS		
112421OJ	HEN60	Hydrant Sling, 4.5 ft L x 4000 lbs Capacity
112421OM	HEN6076	Hydrant Sling, 7.5 ft L x 4000 lbs Capacity
C WEBMASTER® 1600 POLYESTER WEB SLINGS		
112354N82A	EE2801DFX10	Eye & Eye 2-Ply Flat Eyes, 1" W x 10 ft L
112354Q32A	EE2801DFX12	Eye & Eye 2-Ply Flat Eyes, 1" W x 12 ft L
112354S82A	EE2801DFX16	Eye & Eye 2-Ply Flat Eyes, 1" W x 16 ft L
112354WW2C	EE2802DFX6	Eye & Eye 2-Ply Flat Eyes, 2" W x 6 ft L
112354J62C	EE2802DFX7	Eye & Eye 2-Ply Flat Eyes, 2" W x 7 ft L
1123541F2C	EE2802DFX8	Eye & Eye 2-Ply Flat Eyes, 2" W x 8 ft L
112354N82C	EE2802DFX10	Eye & Eye 2-Ply Flat Eyes, 2" W x 10 ft L
112354Q32C	EE2802DFX12	Eye & Eye 2-Ply Flat Eyes, 2" W x 12 ft L
1123541F2E	EE2803DFX8	Eye & Eye 2-Ply Flat Eyes, 3" W x 8 ft L
112354Q32E	EE2803DFX12	Eye & Eye 2-Ply Flat Eyes, 3" W x 12 ft L
112354S82E	EE2803DFX16	Eye & Eye 2-Ply Flat Eyes, 3" W x 16 ft L
112354V22E	EE2803DFX20	Eye & Eye 2-Ply Flat Eyes, 3" W x 20 ft L
1123541F2F	EE2804DFX8	Eye & Eye 2-Ply Flat Eyes, 4" W x 8 ft L
112354Q32F	EE2804DFX12	Eye & Eye 2-Ply Flat Eyes, 4" W x 12 ft L
112354S82F	EE2804DFX16	Eye & Eye 2-Ply Flat Eyes, 4" W x 16 ft L
112354V22F	EE2804DFX20	Eye & Eye 2-Ply Flat Eyes, 4" W x 20 ft L

C&M PART #	MFG PART #	DESCRIPTION
D TUFFEDGE® III POLYESTER WEB SLINGS		
112410N82A	EE2801TFX10	Eye & Eye 2-Ply Flat Eyes, 1" W x 10 ft L
112410Q32A	EE2801TFX12	Eye & Eye 2-Ply Flat Eyes, 1" W x 12 ft L
112410S82A	EE2801TFX16	Eye & Eye 2-Ply Flat Eyes, 1" W x 16 ft L
112410V22A	EE2801TFX20	Eye & Eye 2-Ply Flat Eyes, 1" W x 20 ft L
1124101F2C	EE1802TFTX8	Eye & Eye 1-Ply Flat Tapered, 2" W x 8 ft L
112410N82C	EE1802TFTX10	Eye & Eye 1-Ply Flat Tapered, 2" W x 10 ft L
112410Q32C	EE1802TFTX12	Eye & Eye 1-Ply Flat Tapered, 2" W x 12 ft L
112410V22C	EE1802TFTX20	Eye & Eye 1-Ply Flat Tapered, 2" W x 20 ft L
112410Y72C	EE2802TFTX28	Eye & Eye 2-Ply Flat Tapered, 2" W x 28 ft L
E TUFLEX® POLYESTER ROUNDSLINGS		
11239599WW	EN30X6	Purple Endless Roundsling, 6 ft L
11239599N8	EN30X10	Purple Endless Roundsling, 10 ft L
11239568C1	EN60X4	Green Endless Roundsling, 4 ft L
11239568WW	EN60X6	Green Endless Roundsling, 6 ft L
112395681F	EN60X8	Green Endless Roundsling, 8 ft L
11239568N8	EN60X10	Green Endless Roundsling, 10 ft L
112395D7WW	EN90X6	Yellow Endless Roundsling, 6 ft L
112395D71F	EN90X8	Yellow Endless Roundsling, 8 ft L
112395D7N8	EN90X10	Yellow Endless Roundsling, 10 ft L
112395D7Q3	EN90X12	Yellow Endless Roundsling, 12 ft L
112395A71F	EN150X8	Red Endless Roundsling, 8 ft L
112395A7N8	EN150X10	Red Endless Roundsling, 10 ft L
112395A7Q3	EN150X12	Red Endless Roundsling, 12 ft L
112395A7U5	EN150X18	Red Endless Roundsling, 18 ft L
112395A7V2	EN150X20	Red Endless Roundsling, 20 ft L
F PERMALOC IMPORT WIRE ROPE SLINGS		
112351WW	38IEESCHX6	Eye & Eye Sch 6 X 19 IWRC, 3/8" W x 6 ft L
1123511F	38IEESCHX8	Eye & Eye Sch 6 X 19 IWRC, 3/8" W x 8 ft L
112351Q3	38IEESCHX12	Eye & Eye Sch 6 X 19 IWRC, 3/8" W x 12 ft L
G PERMALOC DOMESTIC WIRE ROPE SLINGS		
112386C117	38EEX4	Eye & Eye Sch 6 X 19 IWRC, 3/8" W x 4 ft L
112386WW17	38EEX6	Eye & Eye Sch 6 X 19 IWRC, 3/8" W x 6 ft L
1123861F17	38EEX8	Eye & Eye Sch 6 X 19 IWRC, 3/8" W x 8 ft L
112386Q317	38EEX12	Eye & Eye Sch 6 X 19 IWRC, 3/8" W x 12 ft L
112386C119	12EEX4	Eye & Eye Sch 6 X 19 IWRC, 1/2" W x 4 ft L
112386WW19	12EEX6	Eye & Eye Sch 6 X 19 IWRC, 1/2" W x 6 ft L
1123861F19	12EEX8	Eye & Eye Sch 6 X 19 IWRC, 1/2" W x 8 ft L
112386N819	12EEX10	Eye & Eye Sch 6 X 19 IWRC, 1/2" W x 10 ft L
112386Q319	12EEX12	Eye & Eye Sch 6 X 19 IWRC, 1/2" W x 12 ft L



Reed Direct Pipe Tapping Machine

Use the Direct Tapping Machine to drill and tap water mains while under pressure. It can be used to install 3/4" or 1" corporation stops in a two-step process. Drill and tap pipes ranging from 4 to 48" cast or ductile iron or C900 PVC pipe with the use of saddles and chain extensions (tapping saddles and drill taps sold separately). The swing valve allows easy change-out from drill tap to corporation insertion tool without main shutdown. Tapping machine uses Reed DT series drill taps. Lightweight yet strong, corrosion-resistant, anodized and epoxy-painted aluminum frames are easy to carry and set-up.



FEATURES & BENEFITS

- Drill and tap water mains while under pressure
- Lightweight corrosion-resistant aluminum frames
- Modular design for fast and simple conversion to drilling machine
- Features a flip clamp feed system

INCLUDES

The TM1100 tapping machine comes with all the necessary parts, including the corp insertion tools—order saddles and drill taps separately

C&M PART #	MFG PART #	SIZE	NOMINAL PIPE SIZE	WEIGHT
103515	TM1100	3/4 to 1	4 to 48"	102 lbs

Saddles are required for use with direct tapping machines. These saddles are made of durable, cast aluminum construction to reduce overall weight. Each saddle is pipe size specific and work with REED® and Mueller® direct tapping machines.

SADDLE ACCESSORIES

C&M PART #	MFG PART #	SIZE	C&M PART #	MFG PART #	SIZE
103540	98442	4" Saddle	103542	98444	18" Saddle
103537	98439	6" Saddle	103543	98445	20" Saddle
103538	98440	8" Saddle	103597	98446	24" Saddle
103539	98441	10" Saddle	103598	98447	36" Saddle
103536	98438	12" Saddle	103599	98448	42" Saddle
103541	98443	16" Saddle	103600	98449	48" Saddle

Drill Taps perform fast with six cutting edges for clean threads and fewer leaks. Have a sharper point for easiest starting.

DRILL TAP ACCESSORIES

C&M PART #	MFG PART #	REED MODEL#	SIZE	THREAD	PIPE MATERIAL
103445	04390	DT75	3/4"	CC AWWA	Cast/Ductile
103446	04391	DT100	1"	CC AWWA	Cast/Ductile
103449	04396	DT75P	3/4"	CC AWWA	C900 PVC
103450	04397	DT100P	1"	CC AWWA	C900 PVC

Reed Feed Tap™ Drilling Machines

Drill through PVC, PE, cast iron and ductile iron pipe (with adapters) while under pressure using Feed Tap Drilling Machine. The compact design, featuring a separate feed for advancing the heavy-duty shell cutter into the pipe, easily allows complete the tap using a drill. For PVC, CPVC and similar plastic pipes, manual power is required.



Order Feed Tap Kit

(103513) for use with power drills. Kit contains both a coupon retaining drill bit and two sets of coupon-retaining magnets. Feed Tap Kit (103601) relies on manual drilling operation and is for use with plastic pipes only.

FEATURES & BENEFITS

- Superior performance and long service life from the carbide-tipped heavy-duty shell cutters
- Coupon retaining pilot drill bit with proven technology provides consistent results
- Impact-resistant sturdy carrying case helps keep tools organized

INCLUDES

Kit 103513 includes machine, corporation adapters, shell cutters, coupon retaining drill bit, two sets of coupon retaining magnets, wrenches, tapping compound and carrying case

Kit 103601 (for plastic pipes only) includes machine, corporation adapters, shell cutters, adapters, a ratchet wrench with socket to cover 3/4 to 2" services in PVC and PE and carrying case

C&M PART #	MFG PART #	SIZE	DESCRIPTION	WEIGHT
103513	09165	3/4 to 2"	Complete Feed Tap Kit for Power Drills	34 lbs
103601	09168	3/4 to 2"	Complete Feed Tap Kit for Manual Drills, Plastic Pipes ONLY	36 lbs

Reed PVC/PE Drilling Machine Kit

Use the Reed PVC/PE Drilling Machine to cut through the pipe wall via the corporation stop inserted into the service saddle while under pressure. The Drilling Machine Kit includes everything you need to tap PVC pipe, including shell cutters. Drill feed rate can handle PVC, C900 and PE pipes with wall thickness up to 1-1/8".



FEATURES & BENEFITS

- Drill through the pipe wall while the system is under pressure
- Steel parts are plated or powder epoxy coated for corrosion resistance
- Easy-to-assemble one-piece stainless steel boring bar

INCLUDES

Drilling machine, base along with corp adapters, 3/4" and 1" PVC/PE shell cutters, NPT to CC AWWA converters, ratchet handle, 7/16" deep well socket and a plastic toolbox

C&M PART #	MFG PART #	SIZE	WEIGHT
103453	04404	3/4" to 1"	11 lbs

Reed Copper Tubing C Cutters

The Copper Tubing C Cutters easily snaps on to copper tubing for a quick, clean cut. Just turn the easy-to-grip cutter in the direction of the arrow and the cut will be complete in seconds. Compact C-shape means no handle swing space is required. The spring-loaded cutter wheel self-feeds on Type K, L, and M copper and CTS CPVC with consistent pressure as the tool is turned around the tubing. Each cutter fits just one size of copper tubing.



FEATURES & BENEFITS

- Compact C-shape—no handle swing space required
- Spring-loaded cutter self-feeds on copper and CTS CPVC
- Consistent pressure is maintained as the tool is turned manually around the tubing
- Light-weight construction at 0.5 lbs

C&M PART #	MFG PART #	DESCRIPTION
103404	03413	3/4" OD Capacity
103405	03414	1" OD Capacity

REPLACEMENT PARTS & ACCESSORIES

C&M PART #	MFG PART #	DESCRIPTION
103402	03375	Replacement Cutting Wheel

Reed Replacement Cutting Wheels for Reed Cutters

All Reed Cutter Wheels are made from high shock-resistant tool steel, while competitive cutter wheels are made from carbon steel or still lower quality tool steel. This higher quality raw material allows these wheels to be made thinner and therefore cut pipes more easily while leaving less burr. The wheels are heat-treated for to resist breakage and last longer.



C&M PART #	MFG PART #	DESCRIPTION
103424	03660	Wheel # O for Copper, Aluminum, Brass & Steel Tubing
103425	03665	Wheel # 30-40 for Copper, Aluminum, Brass & Steel Tubing
103428	04180	Wheel # OP2 for ABS, PE, PEX, PP, PEX/AL/PEX PP, PEX/AL/PEX Tubing
103429	04184	Wheel # 1-2 for ABS, PVC, CPVC, PVDF Tubing
103430	04190	Wheel # 30-40P for ABS, PE, PP Tubing
103431	04194	Wheel # 3-6PVC for ABS, 3 to 6" PVC, 4" Heavy Wall CPVC Tubing

SUGGESTED PRODUCTS

Radians® Crossfire® Cumulus Premium Safety Eyewear



The stylish design of the full frame Crossfire Cumulus is designed for maximum protection. The soft, rubber nose piece allows for all day comfort and the dual mold rubber temples provide grip for better stability.



FEATURES & BENEFITS

- Rubber nose piece for all day comfort
- Dual mold, rubber temple grips for better stability
- Hard coat polycarbonate lens protects against scratches
- Provides 99.9% UVA and UVB protection

CERTIFICATIONS

- Complies with ANSI Z87.1 standards

C&M PART #	MFG PART #	DESCRIPTION
100075	41626	Matte Black Frame, Blue Mirror Lens
100076	411432	Camo Frame, Gold Mirror Lens
100077	41291	Aluminum Gray Frame, Smoke Lens

ICS 695XL Gas Saw Package with Powergrit® Chain



The 695XL is the highest horsepower ICS gas power cutter for frequent use by general construction, utility contractors and concrete professionals. Designed to operate FORCE4® and PowerGrit diamond chains.

SPECIFICATIONS

SAW TYPE	2-Stroke, Single Cylinder, Air Cooled
OPERATING SPEED (rpm)	9400
DISPLACEMENT	5.7 cubic inch (94cc)
HORSEPOWER	6.4
SOUND POWER LEVEL	115 dB(A) (Kwa=1.0 dB(A))
SOUND PRESSURE AT OPERATOR'S EAR	104 dB(A) (Kwa=1.0 dB(A))
WEIGHT (lbs)	21
MATERIAL TO CUT	Ductile and Cast-Iron Pipe, Plastic Pipe, HDPE Pipe, Insituform Pipe Lining, Asbestos* Concrete Pipe

C&M PART #	MFG PART #	DESCRIPTION
104638	575827	Gas Saw Package with Powergrit® Chain

REPLACEMENT PARTS & ACCESSORIES

C&M PART #	MFG PART #	DESCRIPTION
104639	525342	Diamond Chain for Concrete, 15/16"
104640	525343	Diamond Chain for Pipe, 15/16"
104641	525496	Drive Sprocket
104642	544064	Polyester Air Filter
104644*	524490	Guide Bar for Gas Power Cutter

*Designed to operate all ICS FORCE4 and PowerGrit diamond chains.

ICS 890F4 Hydraulic Powerheads



The ICS 890 hydraulic power cutters offer the superior strength of FORCE4® technology. These power cutters are engineered to stand up to your toughest jobs. Designed to operate FORCE4 and PowerGrit diamond chains.

SPECIFICATIONS

C&M PART #	104636	104637
SAW TYPE	Hydraulic	
OPERATING SPEED (rpm)	6100	6500
TORQUE (ft-lbs)	7	10
HORSEPOWER	6	8
SOUND POWER LEVEL	107 dB(A) (K=0.2 dB(A))	
SOUND PRESSURE AT OPERATOR'S EAR	98 dB(A) (K=0.7 dB(A))	
WEIGHT (lbs)	27.3	
MATERIAL TO CUT	Ductile and Cast-Iron Pipe, Plastic Pipe, HDPE Pipe, Insituform Pipe Lining, Asbestos* Concrete Pipe	

HYDRAULIC POWERHEADS

C&M PART #	MFG PART #	DESCRIPTION
104636	566110	Hydraulic Powerhead, 8 GPM/30 LPM, 1 ft/30 cm Hose Whips
104637	566112	Hydraulic Powerhead, 12 GPM/45 LPM, 1 ft/30 cm Hose Whips

DIAMOND CHAINS

C&M PART #	MFG PART #	DESCRIPTION	LENGTH
104639	525342	Diamond Chain for Concrete, 15/16"	16"
104640	525343	Diamond Chain for Pipe, 15/16"	16"

GUIDE BAR

C&M PART #	MFG PART #	DESCRIPTION	LENGTH
104643*	523080	Guidebar for Hydraulic Power Cutter	15"

*Designed to operate all ICS FORCE4 and PowerGrit diamond chains.



Helpful Tip: Be Safe & Stay Protected!

The industry is rapidly changing and employee safety is of high importance. The ICS Ductile Chain Saw is the safest way to cut a pipe, but always remember to wear the appropriate safety gear.

For a complete line of PPE products Core & Main has to offer, see our **Safety** section starting on **page 307**.



Husqvarna® K970 Power Cutters

Use the K970 Power Cutters for a variety of cutting applications including curbstones and pavers in landscaping, metal/pipes in installation work, concrete in buildings and roadwork applications. The semi-automatic SmartTension minimizes the risk of under- and overtensioning. Built-in automatic filter compensation SmartCarb™ maintains high power and lowers fuel consumption. DEX dust suppression system makes it easy to ensure dust is reduced while minimizing water consumption and slurry.

FEATURES & BENEFITS

- SmartTension, semi-automatic belt tensioning
- Light, compact and powerful
- Anti-vibration system reduces vibrations in the cutter handles
- Fully sealed transmission
- Reversible cutting arm—cut closer to walls or the ground



C&M PART #	MFG PART #	POWER	BLADE DIAMETER	HORSEPOWER	PIPE CAPACITY
104956	967348001	Fuel	14"	6.5	5"
104957	967348101	Fuel	16"	6.5	6"

REPLACEMENT PARTS & ACCESSORIES

Service kits include: belt, air filter, fuel filter, spark plug, cord and service tool.

C&M PART #	MFG PART #	DESCRIPTION
104965	599156504	Service Kit for 14" Cutter
104964	599156505	Service Kit for 16" Cutter

Husqvarna® K770 Power Cutter



The K770, 14" Power Cutter can be used for cutting curbstones and pavers in landscaping, metal/pipes in installation work, concrete in buildings as well as roadwork applications. SmartTension, semi-automatic belt tensioning allows for optimal power transmission, minimum wear and maximum belt life. DEX dust suppression system makes it easy to ensure dust is reduced while minimizing water consumption and slurry.

FEATURES & BENEFITS

- SmartTension, semi-automatic belt tensioning
- Exceptional low vibration provides comfort during extended operation periods
- Light, compact and powerful
- Poly-V belt provides better transmission of power

C&M PART #	MFG PART #	POWER	BLADE DIAMETER	HORSEPOWER	PIPE CAPACITY
104955	967682101	Fuel	14"	6.5	5"

REPLACEMENT PARTS & ACCESSORIES

Service kit includes: belt, air filter, fuel filter, spark plug, cord and service tool.

C&M PART #	MFG PART #	DESCRIPTION
104963	599156501	Service Kit

Husqvarna® K970 Ring Saw



Use the K970 Ring Saw for deep cutting irregular openings in concrete, stone and masonry. The maximum depth of cut is 10", twice the amount of a traditional power cutter. The adjustable water valve makes it easy to ensure dust is reduced while minimizing water consumption and slurry.

FEATURES & BENEFITS

- SmartTension, semi-automatic belt tensioning.
- Anti-vibration system reduces vibrations in the cutter handles
- Poly-V belt provides better transmission of power
- Quickest method for small and medium-sized cuts

C&M PART #	MFG PART #	POWER	BLADE DIAMETER	HORSEPOWER	PIPE CAPACITY
104958	967272301	Fuel	14"	6.5	10"

REPLACEMENT PARTS & ACCESSORIES

Service kit includes: belt, air filter, fuel filter, spark plug, cord and service tool.

C&M PART #	MFG PART #	DESCRIPTION
104965	599156504	Service Kit
104970	531108059	Vari-Ring R20 General-Purpose Ring Blade, 14" Diameter



Husqvarna® Replacement Blades



Having the right blades for your job is essential for ease of use and worker safety. Use these durable and efficient blades to cut concrete, asphalt, or other tough materials.

C&M PART #	MFG PART #	BLADE TYPE	BLADE DIAMETER	CUTTING MATERIAL
104966	585580802	Vari-Cut Plus	16"	Reinforced concrete, brick, block, green concrete, and asphalt
104967	585580801	Vari-Cut Plus	14"	
104968	542751360	Vari-Cut	16"	Reinforced concrete, brick, block.
104969	542751359	Vari-Cut	14"	
104970	531108059	Vari-Ring R20	14"	General concrete, reinforced concrete

US Saws Diamond Blades

Select from a variety of superior quality diamond blades to cut various materials such as concrete, asphalt, ductile iron and PVC pipes. All blades have a performance guarantee for the life of the blade.

APPLICATIONS

Tiger Tooth Blade: Ductile Iron Pipe, Plastic Pipe, Cast Iron, Rebar, Angle Iron, Threaded Rod, Reinforced Concrete Pipe*, Wood, Rescue Applications

Piranha Blade: Ductile Iron Pipe, Plastic Pipe, Clay Pipe
Premium Dos Seggie Blade: Ductile Iron Pipe, Plastic Pipe, Cast Iron, Rebar, Angle Iron, Threaded Rod, Reinforced Concrete Pipe, Concrete, Asphalt*, Clay Pipe

Dos Seggie Blade: Ductile Iron Pipe, Plastic Pipe, Cast Iron, Rebar, Angle Iron, Threaded Rod, Reinforced Concrete Pipe, Concrete, Asphalt*, Clay Pipe

The General Blade: Asphalt, Cured Concrete, Concrete Pipe, Brick, Block, Roof Tile

Major Asphalt Blade: Asphalt, Asphalt Over Concrete, Green Concrete

Colonel Concrete Blade: Concrete Pipe, Cured Concrete, Brick, Block

Black-Ops Blade: Cured Concrete, Green Concrete, Concrete Pipe, Brick, Block, Roof Tile

C&M PART #	MFG PART #	BLADE DIAMETER
A TIGER TOOTH BLADES		
101504	APB12125	12"
101505	APB14125	14"
101506	APB16125	16"
101507	APB45080	4.5"
101508	APB08125	8"
B PIRANHA BLADES		
101509	EPB12125	12"
101510	EPB14125	14"
101511	EPB16125	16"
C PREMIUM DOS SEGGIE BLADES		
101512	PXX12125	12"
101513	PXX14125	14"
101514	PXX16125	16"
101515	PXX14125C	14"
D DOS SEGGIE BLADES		
101516	DXX12125	12"
101517	DXX14125	14"
101518	DXX16125	16"

C&M PART #	MFG PART #	BLADE DIAMETER
E THE GENERAL BLADES		
101519	GPS12125	12"
101520	GPS14125	14"
101521	GPS16125	16"
101522	GPS18142	18"
101523	GPS20142	20"
F MAJOR ASPHALT BLADES		
101524	DAS12125	12"
101525	DAS14125	14"
101526	DAS16125	16"
101527	DAS18142	18"
101528	DAS20155	20"
G COLONEL CONCRETE BLADES		
101529	STA12125	12"
101530	STA14125	14"
101531	STA16125	16"
101532	STA18125	18"
101533	STA20125	20"
H BLACK-OPS BLADES		
101534	LCS12125	12"
101535	LCS14125	14"

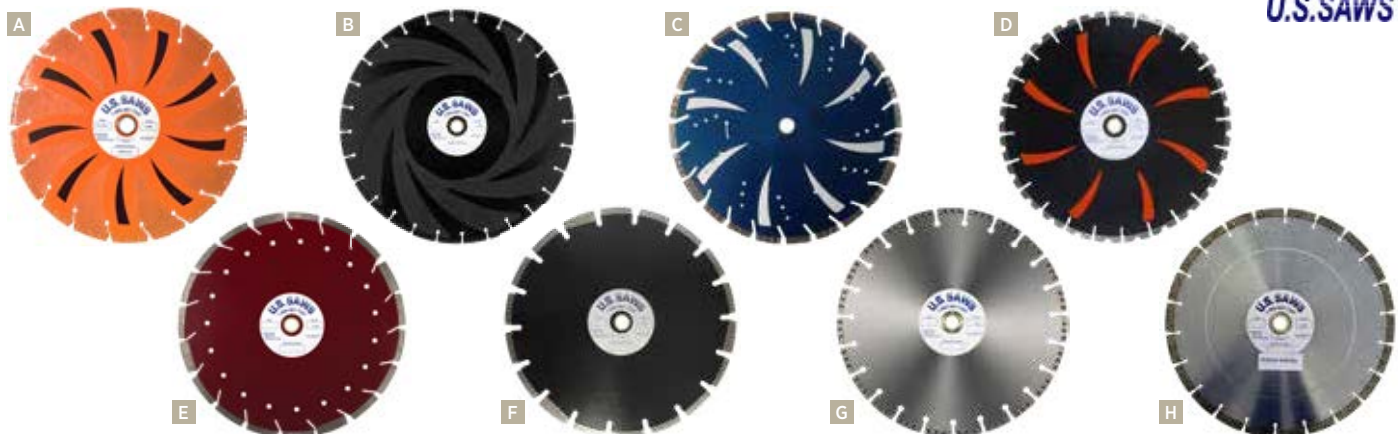

U.S. SAWS®

Core & Main White Label Diamond Blades



Core & Main has teamed up with Diamond Products to produce White Label Diamond Blades for our company.

XXXL-T7XL3 - General Purpose Fast Cutting High Speed Blade. Diamond Depth: 0.433" (11mm). Three distinct segments cater to extended lifespan, swift cutting, and dependable performance:

- General purpose with super-fast cutting for optimal efficiency.
- Serrated turbo segment for the fastest cuts, ensuring top-notch quality and the longest blade life.
- Extended blade life with slant segment wear protection and tall segments, offering reliability that outperforms other multi-segment blades.

A2Z-T7AZ - Ductile, Cast Iron, Metal High Speed Vacuum Bonded Blade.

- Vacuum bonded technology - diamonds are adhered to the gullets.
- Great for rescue and emergency situations
- Cut a wide range of materials.
- Holes in the 'segments' help with cooling while cutting metal and other heat generating materials.

Star Blue-H8B - Star Blue High-Speed Diamond Blade.

- Good quality diamond and good cutting value
- Diamond depth of .375" (10mm)
- Segment height of .475" (12mm)

Imperial Purple-H8ICA - Cut-ALL Multi-Purpose High Speed Specialty Diamond Blades. The Cut-ALL split segment creates a larger weld surface, offering double the weld strength than conventional split segment blades.

- High speed blade with split segment design cuts cured and green concrete, brick and block, pavers, stone, precast, ductile iron and asphalt—best suited for harder materials.
- Great for the general contractor or landscaper whose job is different every day.
- Split segment removes slurry more efficiently for faster and more economical cutting.
- Diamond depth: .310" (8mm) H8CA, .354" (9mm) H8ICA
- Segment height: .410" (10mm) H8CA, .454" (12mm) H8ICA

C&M PART #	MODEL #	SIZE	CUTTING TYPE
112714	XXXL-T7XL3	14" x 0.125" x 1"	General Purpose
112715	A2Z-T7AZ	14" x 0.125" x 1"	Ductile
112716	A2Z-T7AZ	16" x 0.125" x 1"	Ductile
112717	Star Blue-H8B	14" x 0.125" x UNV	Concrete
112718	Imperial Purple-H8ICA	14" x 0.125" x UNV	Cut-All



Reed Cordless Power Drive Valve Operator



Lightweight yet powerful, this Cordless Power Drive Valve Operator is designed for waterworks use. Power drive unit adapts to drilling and tapping machines or attaches to exercise valves. Weighing about 15 pounds, it is easy to handle and provides impressive torque.

Power switch has locking position but stops almost immediately when released ensuring worker safety. With a simple change of the drophead, power drive adapts for tapping/drilling or valve turning. For pipe tapping, add the tapping machine adapter (103582) to connect Reed and other common tapping or drilling machines. Order utility clutch (05287) for valve work. Power source is Bosch® angle grinder—provide 18V Bosch® battery separately.

FEATURES & BENEFITS

- Battery power which means no pneumatic or electric drop lines
- Convenient carrying handle offers support for valve turning
- Motor power kick-off feature provides added operator safety
- Compact unit fits easily into ditches

C&M PART #	MFG PART #	DESCRIPTION
103473	05258	18V Cordless Power Drive Valve Operator

REPLACEMENT PARTS & ACCESSORIES

C&M PART #	MFG PART #	DESCRIPTION
103523	92344	Valve Key, Pivot Head Lower Shaft, 2"
103524	92358	Valve Key Extension Shaft, Plated
103580	05295	Cordless Power Drive Digital Counter
103581	92339	Valve Key Lower Shaft with 2" Key
103582	08430	Power Drive Adapter
103583	98185	Bosch 4AH Battery, 18V
103584	98187	Bosch 18V Battery Charger
103585	98197	Bosch 8AH Battery, 18V



Helpful Tip:
Core & Main has what you need!

Core and Main has everything you need to cut a pipe, drill a pipe, lift a pipe and fasten a pipe.

Shop supply.coreandmain.com to view our full range of products.

Hydroverge Hydrant Buddy



Valve exercising can be an arduous process with heavy equipment and repetitive motions that can lead to worker injury. Simplify the process with Hydrant Buddy, a lighter and easier-to-use product that works faster and decreases risk of injury. It is powered by a Milwaukee industrial motor and custom engineered gearbox.

FEATURES & BENEFITS

- Lightweight design minimizes worker injuries like:
 - » Rotator cuff tears and tendonitis
 - » Lower back strain and fatigue
 - » Tennis elbow
 - » Joint pain
 - » Pinched spinal nerves
 - » Carpal tunnel
- The Hydrant Buddy costs less than one single injury payout while keeping your team safer.
- Digital rotation counter for error free counting
- 3-year comprehensive warranty on all parts

INCLUDES

Charger, two rechargeable batteries, adjustable pentagon socket and heavy-duty carrying bag

SPECIFICATIONS

MODEL TYPE	Cordless
WIDTH	6.5"
LENGTH	26"
HEIGHT	12" (output drive to motor handle)
WEIGHT	22.5 lbs. with socket and battery
BATTERY CAPACITY	Up to 20 hydrants / 10 gate valves
BATTERY CHARGE TIME	65 minutes
VARIABLE SPEED	Up to 30 RPMs
TORQUE*	Up to 400 lb-ft

*This is lower than states because this is the torque the tool starts out with. Over time, the tool will have less friction and more torque.

C&M PART #	MFG PART #	DESCRIPTION
112096	HB1	Portable Cordless Hydrant and Gate Valve Exerciser

REPLACEMENT PARTS & ACCESSORIES

C&M PART #	MFG PART #	DESCRIPTION
112097	GVK-S	Adjustable Gate Valve Key, 48 to 82"
112098	GVK-L	Adjustable Gate Valve Key, 78 to 135"
112099	HBS-2	Hydrant Buddy 2" Square Socket
112100	HBS-5A	Adjustable 5-Point Socket
112101	HBS-3A	Adjustable 3-Point Socket
112102	HBS-114	4-Point Socket, 1-1/4"
112103	HBS-1M	3/4" Female to 1" Male Adapter



WE'D LIKE YOUR FEEDBACK



Let us know what you think of our catalog and website!

Send us your thoughts at support.supply@coreandmain.com

Process Analyzers



TABLE OF CONTENTS

Chlorine Analyzers & Accessories	262-267
Conductivity	268
Controllers	269-271
Fluoride	272
Hardness/pH	273
pH/ORP Analyzers & Accessories	274-275
Turbidimeters & Accessories	276-277
Dissolved Oxygen	278
Field Testing Meters	279-280

Hach CL17sc Colorimetric Chlorine Analyzer

The Hach® CL17sc online chlorine analyzer uses EPA-approved colorimetric DPD analysis to deliver accurate and reliable free or total residual chlorine measurements. Use the online chlorine measurements to easily optimize your process or report to regulatory agencies. A built-in flowmeter, three-color status light, LED measurement cycle lights and colorimeter window allow you to quickly and efficiently see that your CL17sc analyzer is functioning properly. The analyzer helps reduce your routine maintenance touch time with programmable alerts, simplified tubing replacement and step-by-step maintenance instructions.

Connect to Hach's SC controller platform to transfer, store and interact with your chlorine measurement data, resulting in better understanding and control of your process, more cost-effective decision-making, and greater peace of mind that your data is always there no matter what happens. The CL17sc analyzer is compatible with all current Hach SC controllers—order controllers separately. Analyzers are available with standpipe kit or pressure regulator kit.

FEATURES & BENEFITS

- Accurate, reliable online measurement of free or total residual chlorine
- On-screen, guided workflows for routine maintenance tasks
- Comprehensive diagnostic features, including built-in flowmeter, multicolor status light and colorimeter window
- Compatible with all current Hach SC controllers

INCLUDES

Standpipe Models: CL17sc analyzer, standpipe installation kit and Y-strainer, tubing kit and user manual; One-month of reagents included with certain part numbers. 1-year warranty

Pressure Regulator Models: CL17sc analyzer, pressure regulator installation kit and Y-strainer, tubing kit and user manual; One-month of reagents included with certain part numbers. 1-year warranty

SPECIFICATIONS

RANGE	0.03 to 10 mg/L Free or Total Residual Chlorine
LOWER LIMIT OF DETECTION	0.03 mg/L Free or Total Residual Chlorine
ACCURACY	±5% or ±0.04 mg/L (Whichever is Greater) from 0 to 5 mg/L Cl ₂ ; ± 10% from 5 to 10 mg/L Cl ₂
CYCLE TIME	2.5 Minutes
CONTROLLER COMPATIBILITY	SC200, SC1000, SC4500
TUBING CONNECTIONS INLET (SAMPLE) OUTLET (WASTE DRAIN)	1/4" OD Polyethylene Tube, Quick-Connect Fitting 1/2" ID Flexible Tubing
ENCLOSURE RATING	IP66
INLET PRESSURE	4.5 to 75 PSIG Supplied to Y-Strainer 1.5 to 5 PSIG Supplied to Analyzer
OPERATING TEMPERATURE	41 to 104°F
POWER	12 VDC, Supplied by Hach SC Controller
DISPLAY	Supplied by Hach SC Controller
DATA OUTPUT	Digital Signal to Hach SC Controller
DIMENSIONS (H x W x D)	13.5" x 12.9" x 6.7"
SAMPLE REQUIREMENTS	Y-Strainer Filtration with 40-Mesh Screen or Higher
SAMPLE FLOW RATE	60 to 200 mL/min Through the Analyzer

CERTIFICATIONS

- Compliant with US EPA 40 CFR 141.74



C&M PART #	MFG PART #	DESCRIPTION	REAGENTS INCLUDED
702392	8572300	CL17sc Analyzer with Standpipe Kit	No
702394	8572700	CL17sc Analyzer with Standpipe Kit	Free Chlorine
702395	8572800	CL17sc Analyzer with Standpipe Kit	Total Chlorine
702393	8572400	CL17sc Analyzer with Pressure Regulator Kit	No
702396	8572900	CL17sc Analyzer with Pressure Regulator Kit	Free Chlorine
702397	8573000	CL17sc Analyzer with Pressure Regulator Kit	Total Chlorine

REAGENTS

C&M PART #	MFG PART #	DESCRIPTION
700128	2556900	Free Chlorine Reagent Set
701687	2557000	Total Chlorine Reagent Set
701400	2297255	DPD Compound, 24 g
701417	2314011	Free Chlorine Indicator Solution, 473 mL
701418	2314111	Free Chlorine Buffer Solution, 473 mL
701359	2263411	Total Chlorine Indicator Solution, 473 mL
701360	2263511	Total Chlorine Buffer Solution, 473 mL

REPLACEMENT PARTS & ACCESSORIES

C&M PART #	MFG PART #	DESCRIPTION
702387	8560400	CL17sc Tubing Kit (Pre-Assembled)
702398	8573100	CL17sc Cell Cleaning Kit
700876	244932	Sulfuric Acid Solution, 5.25 N, 100 mL Dropper Bottle
701686	2554300	Cotton Swabs, Presterilized, Pack of 100
702391	8568200	CL17sc Calibration Verification Kit
702399	8573200	CL17sc Calibration Verification Refill Kit
702137	4743800	Sample Stream Tubing, 1/4" OD by 7 ft, Polyethylene
111286D003X2	0500-0625-062-11-03-00025	Sample Waste Tubing, 1/2" ID by 25 ft, Polyethylene
702388	8560500	CL17sc Standpipe Installation Kit
702389	8565700	CL17sc Pressure Regulator Installation Kit

HACH SC4500 CONTROLLERS & INSTALLATION ACCESSORIES

C&M PART #	MFG PART #	DESCRIPTION
704084	LXV525.99A11501	SC4500 Controller with One Digital Sensor Input, 100 to 240 VAC, No Cord
704086	LXV525.99A11551	SC4500 Controller with Two Digital Sensor Inputs, 100 to 240 VAC, No Cord
704108	LXV525.99E11551	SC4500 Controller with Two Digital Sensor Inputs, 100 to 240 VAC, US Plug
704182	LXV525.99Z11551	SC4500 Controller with Two Digital Sensor Inputs, 24 VDC, No Cord
702245	5448800	Power Cord with Strain Relief for SC4500 Controller, 125 VAC
702310	6122400	Digital Extension Cable, 3.3 ft
702271	5796000	Digital Extension Cable, 25 ft

Hach CL17 Reagents & Accessories

Hach® reagents and replacement parts provide a guarantee of accurate, consistent results. Hach Chlorine Reagents Sets can be used with both CL17 and CL17sc analyzers.

The Free Chlorine Reagent Set includes:

One 24-gram bottle of DPD compound (C&M Part # 701400), One 473-mL bottle of free chlorine indicator solution (C&M Part # 701417), & One 473-mL bottle of free chlorine buffer solution (C&M Part # 701418).

The Total Chlorine Reagent Set includes: One 24-gram bottle of DPD compound (C&M Part # 701400), One 473-mL bottle of total chlorine indicator solution (C&M Part # 701359), and One 473-mL bottle of total chlorine buffer solution (C&M Part # 701360).

CERTIFICATIONS

- Compliant with US EPA 40 CFR 141.74

HACH CL17 & CL17SC REAGENTS

C&M PART #	MFG PART #	DESCRIPTION
700128	2556900	Free Chlorine Reagent Set
701687	2557000	Total Chlorine Reagent Set
701400	2297255	DPD Compound, 24 g
701417	2314011	Free Chlorine Indicator Solution, 473 mL
701418	2314111	Free Chlorine Buffer Solution, 473 mL
701359	2263411	Total Chlorine Indicator Solution, 473 mL
701360	2263511	Total Chlorine Buffer Solution, 473 mL

HACH CL17SC REPLACEMENT PARTS & ACCESSORIES

C&M PART #	MFG PART #	DESCRIPTION
702387	8560400	CL17sc Tubing Kit (pre-assembled)
707695	8573100	CL17sc Cell Cleaning Kit
700876	244932	Sulfuric Acid Solution, 5.25 N, 100 mL Dropper Bottle
701686	2554300	Cotton Swabs, Presterilized, Pack of 100
702391	8568200	CL17sc Calibration Verification Kit
702399	8573200	CL17sc Calibration Verification Refill Kit
702137	4743800	Sample Stream Tubing, 1/4" OD by 7 ft., Polyethylene
111286D003X2	0500-0625-062-11-03-00025	Sample Waste Tubing, 1/2" ID by 25 ft., Polyethylene
702388	8560500	CL17sc Standpipe Installation Kit
702389	8565700	CL17sc Pressure Regulator Installation Kit



700128



702391

702387

707695

702239

HACH CL17 REPLACEMENT PARTS & ACCESSORIES

C&M PART #	MFG PART #	DESCRIPTION
702238	5444300	CL17 Maintenance Kit
702239	5444301	CL17 Maintenance Kit with Pre-Assembled Tubing
702320	6865600	CL17 Stir Bar
702234	5440400	Main Circuit Board
702321	6867000	Colorimeter Assembly, 510 nm
702322	6868500	Colorimeter Plug
700818	203832	Sulfuric Acid Solution, 19.2 N, 100 mL Dropper Bottle
701686	2554300	Cotton Swabs, Presterilized, Pack of 100
707696	5410100	Stainless Steel Thumbscrew for Pressure Plate
702213	5411800	Compact Pressure Analyzer Plate
702064	4271700	C-Flex® Tubing, 0.063" ID x 0.193" OD, Per Foot
702065	4274100	Compact Analyzer Reagent Block
702066	4274200	Compact Analyzer Sample Block
702241	5445200	Cam/Coupler Assembly
702240	5444600	Gear Motor Assembly
702210	5410700	Optical Switch (Pump Home Sensor at Cam/Coupler Assembly)
702061	4207600	C-Flex Tubing, 1/16" ID x 1/8" OD, Per Foot
702068	4329300	C-Flex Tubing, 1/8" ID x 1/4" OD, Per Foot
702078	4425300	C-Flex Tubing, 1/32" ID x 3/32" OD, Per Foot
701087	1971900	Quad Ring Seal, 1/4" ID
702252	5516400	Full Analyzer Installation Kit (Order Stir Bar Separately)
702229	5418400	Compact Analyzer Mesh Screen, 40 Mesh
702135	4735100	Water Pressure Regulator, Non-Relieving, Adjustable
702136	4735800	Water Pressure Regulator, Non-Relieving, Pre-set
701078	1850600	Y-Strainer Assembly, 40 Mesh
707697	4458200	Wiring Connector for Alarm or Recorder
702151	4952600	Replacement Fuse, 2.5 A, 250 V, 5 mm x 20 mm
702245	5448800	Power Cord, 125V
701965	2835900	Calibration/Verification Refill Kit 2-500 mL Bottles of Organic Free Water; 1-20mL Voullette of 110 ppm Chlorine Standard



Helpful Tip: Principle of Operation of CL17 and CL17sc Analyzers

The CL17sc Colorimetric Chlorine Analyzer has three operating components:

- A linear peristaltic pump to precisely control the volume of incoming samples and reagents
- A colorimeter
- Indicator and buffer solutions

A "zero" reference point is established at the beginning of the cycle by measuring blank absorbance. This compensates for the color intensity and turbidity of the sample before the chlorine measurement is made. Indicator and buffer solutions are then added to the sample while a magnetic stirrer mixes the solution. Once the sample changes color, the light transmitted through the sample is measured using a colorimeter. The measured color intensity is compared to a reference standard. Finally, the sample cell is flushed with new sample so that the cycle can repeat every 2.5 minutes.





REQUEST YOUR FREE COPY of Core & Main's Lab Essentials Catalog Today.



Scan the QR code here
to order your catalog.

You can also visit supply.coreandmain.com to shop our growing assortment of products tailored to the water & wastewater operator.

Hach Ultra Low Range (ULR) CL17sc Colorimetric Chlorine Analyzer

Online residual chlorine measurement options for ultra-low range have been either inadequate or inefficient—until now. The Ultra Low Range CL17sc analyzer provides direct total chlorine results down to 8 ppb, eliminating the need for ORP or amperometric measurement. The analyzer uses colorimetric DPD Standard Method 4500-Cl G and consistently maintains accuracy without loss of sensitivity in your new target range. Whether treating utility water, product water or wastewater discharge, you'll have the direct chlorine measurements you need to optimize your process, protect valuable assets and report to regulatory agencies with confidence.

Connect to Hach®'s SC controller platform to transfer, store and interact with your chlorine measurement data, resulting in better understanding and control of your process, more cost-effective decision-making, and greater peace of mind that your data is always there no matter what happens. The Ultra Low Range CL17sc analyzer is compatible with all current Hach SC controllers—order controllers separately. Analyzer is available with standpipe kit or pressure regulator kit.

FEATURES & BENEFITS

- Accuracy in the parts-per-billion range!
- Cumulative Chlorine Counter™ allows for tracking chlorine exposure to downstream assets over time
- Reliable, accurate colorimetric DPD chemistry
- Comprehensive diagnostic features, including built-in flowmeter, multicolor status light and colorimeter window
- Compatible with all current Hach SC controllers

INCLUDES

Standpipe Models: ULR CL17sc analyzer, standpipe installation kit and Y-strainer, tubing kit and user manual; One-month of reagents included with certain part numbers; 1-year warranty

Pressure Regulator Models: ULR CL17sc analyzer, pressure regulator installation kit and Y-strainer, tubing kit and user manual; One-month of reagents included with certain part numbers; 1-year warranty

SPECIFICATIONS

RANGE	0.008 to 5 mg/L Total Chlorine
LOWER LIMIT OF DETECTION	0.008 mg/L Total Chlorine
ACCURACY	±5% or ±0.01 mg/L (Whichever is Greater) from 0 to 4 mg/L Cl ₂ ; ±10% from 4 to 5 mg/L Cl ₂
CYCLE TIME	2.5 minutes
CONTROLLER COMPATIBILITY	SC200, SC1000, SC4500
TUBING CONNECTIONS	
INLET (SAMPLE)	1/4" OD Polyethylene Tube, Quick-Connect Fitting
OUTLET (WASTE DRAIN)	1/2" ID Flexible Tubing
ENCLOSURE RATING	IP66
INLET PRESSURE	4.5 to 75 PSIG Supplied to Y-Strainer 1.5 to 5 PSIG Supplied to Analyzer
OPERATING TEMPERATURE	41 to 104°F
POWER	12 VDC, Supplied by Hach SC Controller
DISPLAY	Supplied by Hach SC Controller
DATA OUTPUT	Digital Signal to Hach SC Controller
DIMENSIONS (H X W X D)	13.5" x 12.9" x 6.7"
SAMPLE REQUIREMENTS	Y-Strainer Filtration with 40-Mesh Screen or Higher
SAMPLE FLOW RATE	60 to 200 mL/min Through the Analyzer



CERTIFICATIONS

- Compliant with US EPA 40 CFR 141.74

C&M PART #	MFG PART #	DESCRIPTION	REAGENTS INCLUDED
707698	9790200	ULR CL17sc Analyzer with Standpipe Kit	No
707699	9793300	ULR CL17sc Analyzer with Standpipe Kit	Total Chlorine
707700	9790300	ULR CL17sc Analyzer with Pressure Regulator Kit	No
707701	9793400	ULR CL17sc Analyzer with Pressure Regulator Kit	Total Chlorine

REAGENTS

C&M PART #	MFG PART #	DESCRIPTION
707702	9791100	ULR Total Chlorine Reagent Set
701400	2297255	DPD Compound, 24 g
701359	2263411	Total Chlorine Indicator Solution, 473 mL
701360	2263511	Total Chlorine Buffer Solution, 473 mL

REPLACEMENT PARTS & ACCESSORIES

C&M PART #	MFG PART #	DESCRIPTION
702387	8560400	CL17sc Tubing Kit (Pre-Assembled)
702398	8573100	CL17sc Cell Cleaning Kit
700876	244932	Sulfuric Acid Solution, 5.25 N, 100 mL Dropper Bottle
701686	2554300	Cotton Swabs, Sterilized, Pack of 100
702391	8568200	CL17sc Calibration Verification Kit
702399	8573200	CL17sc Calibration Verification Refill Kit
702137	4743800	Sample Stream Tubing, 1/4" OD by 7 ft, Polyethylene
111286D003X2	0500-0625-062-11-03-00025	Sample Waste Tubing, 1/2" ID by 25 ft, Polyethylene
702388	8560500	CL17sc Standpipe Installation Kit
702389	8565700	CL17sc Pressure Regulator Installation Kit

HACH SC4500 CONTROLLERS & INSTALLATION ACCESSORIES

C&M PART #	MFG PART #	DESCRIPTION
704084	LXV525.99A11501	SC4500 Controller with One Digital Sensor Input, 100 to 240 VAC, No Cord
704086	LXV525.99A11551	SC4500 Controller with Two Digital Sensor Inputs, 100 to 240 VAC, No Cord
704108	LXV525.99E11551	SC4500 Controller with Two Digital Sensor Inputs, 100 to 240 VAC, US Plug
704182	LXV525.99Z11551	SC4500 Controller with Two Digital Sensor Inputs, 24 VDC, No Cord
702245	5448800	Power Cord with Strain Relief for SC4500 Controller, 125 VAC
702310	6122400	Digital Extension Cable, 3.3 ft
702271	5796000	Digital Extension Cable, 25 ft



Hach CLF10sc & CLT10sc Amperometric Chlorine Analyzers

The CLF10sc Free Chlorine Analyzer and CLT10sc Total Chlorine Analyzer continuously measure free and total chlorine for real time monitoring and process control. The analyzers utilize amperometric technology and are fully compatible with all Hach® digital controllers. Amperometric chlorine technology by Hach does not use reagents, eliminating the need for a sanitary drain and saving you the cost of monthly reagent replacement.



Use the CLF10sc and CLT10sc analyzers in most municipal and industrial applications. They are best utilized where waste stream management is a constraint. The analyzers are compliant with EPA Method 334.0, ensuring that you not only have precise process control, but reportable results as well.

Simply plug in to a Hach digital controllers to use. Exclusive self-diagnostics feature alerts the user to changes in the process or upcoming maintenance. The Cal Watch feature provides a warning for pH or chlorine calibration changes and a noncontacting flow sensor notifies users of insufficient sample flow.

The CLF10sc and CLT10sc analyzers are available as complete systems with single- or dual-input controllers, or as panel-only systems where controllers must be purchased separately. Choose from different pH monitoring configurations including differential pH electrode, combination pH electrode, or the grab sample option.

FEATURES & BENEFITS

- Use for reporting chlorine residual measurements in accordance with EPA Method 334.0
- Real-time monitoring for chlorine and pH
- No reagent replacement or waste stream management during the normal course of operation
- Compatible with any Hach SC digital controller
- Self-diagnostics alerts users of process changes or servicing needs
- Exclusive Cal Watch algorithm warns when pH and chlorine calibration deviates
- Noncontacting flow sensor monitors sample flow and alerts when flow is insufficient

INCLUDES

Complete Systems: CLT10sc mounting panel, chlorine sensor with flow cell, pH flow cell, flow sensor, digital gateway and controller; pH electrodes are included with certain part numbers as indicated in the ordering table

Panel-Only Systems: CLT10sc mounting panel, chlorine sensor with flow cell, pH flow cell, flow sensor and digital gateway; pH electrodes are included with certain part numbers as indicated in the ordering table; Controllers must be purchased separately

SPECIFICATIONS

CHLORINE RANGE	0.03 to 20 mg/L Free or Total Residual Chlorine
PH RANGE	4 to 9 pH
LOWER LIMIT OF DETECTION	0.03 mg/L Free or Total Residual Chlorine
ACCURACY (AS COMPARED TO DPD REFERENCE TEST)	
FREE CHLORINE:	±3% at Constant pH < 7.2 ±10% at Stable pH < 8.5
TOTAL CHLORINE:	±10% at Stable pH < 8.5 ±20% at Stable pH > 8.5
CYCLE TIME	Continuous
CONTROLLER COMPATIBILITY	SC200, SC1000, SC4500
TUBING CONNECTIONS	
INLET (SAMPLE)	1/4" OD Flexible Tubing
OUTLET (WASTE DRAIN)	1/2" ID Flexible Tubing
OPERATING TEMPERATURE	41 to 113°F
ENCLOSURE RATING	IP65
POWER	12 VDC, Supplied by Hach SC Controller
DISPLAY	Supplied by Hach SC Controller
DIMENSIONS (H x W x D)	19" x 19.5" x 5.95"
SAMPLE FLOW RATE	7.9 to 13.2 gal/hour (10.5 gal/hour is Optimal)

CERTIFICATIONS

- Compliant with US EPA 40 CFR 141.74

C&M PART #	MFG PART #	DESCRIPTION	PARAMETER
COMPLETE SYSTEMS WITH SINGLE-INPUT SC4500 CONTROLLER			
704210	LXV525.97KT0004	CLF10sc Analyzer with Chlorine Sensor and Grab Sample for pH	Free Chlorine
704211	LXV525.97KT0002	CLF10sc Analyzer with Chlorine Sensor and Combination pH Electrode	Free Chlorine
704212	LXV525.97KT0001	CLF10sc Analyzer with Chlorine Sensor and Differential pH Electrode	Free Chlorine
COMPLETE SYSTEMS WITH DUAL-INPUT SC4500 CONTROLLER			
704207	LXV525.97KT0025	CLF10sc Analyzer with Chlorine Sensor and Grab Sample for pH	Free Chlorine
704208	LXV525.97KT0024	CLF10sc Analyzer with Chlorine Sensor and Combination pH Electrode	Free Chlorine
704209	LXV525.97KT0020	CLF10sc Analyzer with Chlorine Sensor and Differential pH Electrode	Free Chlorine
704205	LXV525.97KT0029	CLT10sc Analyzer with Chlorine Sensor and Grab Sample for pH	Total Chlorine
704206	LXV525.97KT0023	CLT10sc Analyzer with Chlorine Sensor and Combination pH Electrode	Total Chlorine
PANEL-ONLY SYSTEMS (CONTROLLER NOT INCLUDED)			
703660	LXV45A.99.11022	CLF10sc Analyzer with Chlorine Sensor and Grab Sample for pH	Free Chlorine
703661	LXV45A.99.12022	CLF10sc Analyzer with Chlorine Sensor and Combination pH Electrode	Free Chlorine
703662	LXV45A.99.13022	CLF10sc Analyzer with Chlorine Sensor and Differential pH Electrode	Free Chlorine
703663	LXV45B.99.11022	CLT10sc Analyzer with Chlorine Sensor and Grab Sample for pH	Total Chlorine
703664	LXV45B.99.12022	CLT10sc Analyzer with Chlorine Sensor and Combination pH Electrode	Total Chlorine
703665	LXV45B.99.13022	CLT10sc Analyzer with Chlorine Sensor and Differential pH Electrode	Total Chlorine

Continued on Next Page



Hach CLF10sc & CLT10sc Amperometric Chlorine Analyzers *(continued)*



702448



702412



REPLACEMENT PARTS & ACCESSORIES

C&M PART #	MFG PART #	DESCRIPTION
702412	8633100	Replacement Membrane Kit for CL10sc Analyzers
702448	9160600	CLF10sc Free Chlorine Electrolyte
702404	8626200	CLF10sc Replacement Sensor
702454	9181400	CLT10sc Total Chlorine Electrolyte
702411	8628900	CLT10sc Replacement Sensor
702450	9180100	Flow Cell Assembly for Differential pH Electrode
702451	9180200	Flow Cell Assembly for Combination pH Electrode
702459	9198400	Flow Cell Assembly for Chlorine Sensor
702456	9181600	Combination pH Electrode for CL10sc Analyzers
702455	9181500	pH Differential pH Electrode for CL10sc Analyzers
702704	25M1A1025-115	Standard Cell Solution for Differential pH Electrodes
704051	SB-RISV	Salt Bridge with O-Ring for Differential pH Electrodes
702457	9198100	Tubing for Sample Stream, 3/8" x 18"
702137	4743800	Tubing for Sample Stream Inlet, 1/4" x 6.5 ft
702458	9198200	Tubing for Waste Stream Outlet, 1/2" x 6.5 ft
702446	9159900	Pressure Regulator Sample Conditioning Kit

HACH SC4500 CONTROLLERS & INSTALLATION ACCESSORIES

C&M PART #	MFG PART #	DESCRIPTION
704084	LXV525.99A11501	SC4500 Controller with One Digital Sensor Input, 100 to 240 VAC, No Cord
704086	LXV525.99A11551	SC4500 Controller with Two Digital Sensor Inputs, 100 to 240 VAC, No Cord
704108	LXV525.99E11551	SC4500 Controller with Two Digital Sensor Inputs, 100 to 240 VAC, US Plug
704182	LXV525.99Z11551	SC4500 Controller with Two Digital Sensor Inputs, 24 VDC, No Cord
702245	5448800	Power Cord with Strain Relief for SC4500 Controller, 125 VAC
702310	6122400	Digital Extension Cable, 3.3 ft
702271	5796000	Digital Extension Cable, 25 ft

NEED HELP FINDING AN ITEM?



Core & Main has access to thousands of products from hundreds of suppliers.

Check out our full assortment of products and suppliers online at supply.coreandmain.com or speak with one of our customer service representatives at **1-888-885-2673**.



Helpful Tip: Cleaning the Hach CL17sc

Hach recommends cleaning the CL17sc cell on a monthly (or as needed) basis. Frequency of cleaning may depend on the application and sample qualities. The CL17sc Cell Cleaning Kit (Core & Main part number 707695) contains 5.25N sulfuric acid (100 mL dropper bottle) and cotton swabs (10).

Hach Conductivity Sensors



These Conductivity Sensors feature a built-in 1000 Ω platinum RTD that compensates the measured conductivity for changes in process temperature, resulting in excellent accuracy. Select from contacting and inductive (electrodeless) conductivity sensors.

The Contacting Conductivity Sensors are manufactured to exacting tolerances using high quality, rugged materials for demanding applications, including ultra-pure water, clean-in-place (CIP), and boiler/condensate monitoring. Each sensor is tested to determine its unique, absolute four-digit cell constant. These enhanced performance sensors measure from 0.057 $\mu\text{S}/\text{cm}$ or 18.2 $\text{M}\Omega$ (theoretically pure water) up to 200,000 $\mu\text{S}/\text{cm}$.

The Inductive (Electrodeless) Conductivity Sensors measure from 200 up to 2,000,000 $\mu\text{S}/\text{cm}$. The inductive sensor design eliminates polarization and electrode coating problems that commonly affect conventional contacting electrode-type conductivity sensors.

All digital conductivity sensors work with Hach® SC controllers with digital inputs. Analog conductivity sensors also work with Hach SC controllers as long as analog inputs are available.

FEATURES & BENEFITS

- Conductive or Inductive sensor options ensure that any application can be met
- Choose from digital or analog communication options

INCLUDES

Digital conductivity sensors come complete with standard sensor cable (20 ft), digital gateway and digital gateway extension cable (3.3 ft); Analog conductivity sensors come complete with standard 6-wire sensor cable (20 ft); 1-year warranty

SPECIFICATIONS

SENSOR CELL CONSTANT; INHERENT MEASURING RANGE	Contacting: K = 0.5; Conductivity 0 to 1,000 $\mu\text{S}/\text{cm}$ K = 1; Conductivity 0 to 2,000 $\mu\text{S}/\text{cm}$ K = 5; Conductivity 0 to 10,000 $\mu\text{S}/\text{cm}$ K = 10; Conductivity 0 to 200,000 $\mu\text{S}/\text{cm}$ Inductive: N/A
FLOW RATE	10 ft/sec maximum
OPERATING TEMPERATURE	-4 to 392°F
TEMPERATURE COMPENSATOR	Pt 1000 RTD
RANGE	Contacting: 0.057 to 200,000 $\mu\text{S}/\text{cm}$ Inductive: 200 to 2,000,000 $\mu\text{S}/\text{cm}$

CERTIFICATIONS

- Compliant with US EPA 40 CFR 141.74

C&M PART #	MFG PART #	PROBE STYLE	ANALOG/DIGITAL	CELL CONSTANT	BODY MATERIAL
702812	3433B8A	Contacting	Analog	K = 0.5	Graphite/Ryton
702787	3422B4A	Contacting	Analog	K = 0.5	Titanium with SS Compression Fitting
702793	3422C3A	Contacting	Analog	K = 1.0	Titanium with PVDF Compression Fitting
702804	3422D4A	Contacting	Analog	K = 5.0	Titanium with SS Compression Fitting
702847	3725E2T	Inductive	Analog	-	Polypropylene
702855	3727E2T	Inductive	Analog	-	PEEK
703310	D3433B8	Contacting	Digital	K = 0.5	Graphite/Ryton
703305	D3422B4	Contacting	Digital	K = 0.5	Titanium with SS Compression Fitting
703306	D3422C3	Contacting	Digital	K = 1.0	Titanium with PVDF Compression Fitting
703308	D3422D4	Contacting	Digital	K = 5.0	Titanium with SS Compression Fitting
703323	D3725E2T	Inductive	Digital	-	Polypropylene
703328	D3727E2T	Inductive	Digital	-	PEEK

REPLACEMENT PARTS & ACCESSORIES

C&M PART #	MFG PART #	DESCRIPTION
703911	MH432G	4 ft x 1/2" CPVC Pipe Mount with Junction Box
703922	MH538N3NZ	Inline Mount Hardware, 2" CPVC Tee & Union Adapter
702662	1W1100	6-Wire Analog Sensor Extension Cable (Order per Foot)
702301	5867000	Digital Sensor Junction Box*
702310	6122400	Digital Sensor Extension Cable, 3 ft
702271	5796000	Digital Sensor Extension Cable, 25 ft
702273	5796100	Digital Sensor Extension Cable, 50 ft
702275	5796200	Digital Sensor Extension Cable, 100 ft
702307	6120700	Replacement Digital Conductivity Gateway, Contacting
702309	6120800	Replacement Digital Conductivity Gateway, Inductive

*Required for total cable lengths 328 to 3280 ft.

Hach SC4500 Controllers

The Hach® SC4500 Controller integrates easily into your current system while allowing you to upgrade your system without having to replace inventory. The controller series has a wide range of analog and digital connectivity options and the availability of intelligent instrument and data management features.

Communicate with a SCADA system or PLC with several options for transmitting data, ranging from analog outputs to advanced digital protocols as well as Wi-Fi, cellular or LAN options. The easy-to-use touchscreen makes installation and integration of the SC4500 controller seamless. Built-in predictive diagnostic software ensures measurement confidence and reduces the risk of unexpected equipment downtime by enabling proactive maintenance planning, including step-by-step instructions. Install the controller indoors or outdoors, with power options available for either AC or DC power.

FEATURES & BENEFITS

- Compatible with Hach's full SC sensor portfolio
- Multiple output options to PLC/SCADA, including analog output or digital output such as Modbus TCP/IP, Profibus DP, Ethernet/IP, and Profinet IO
- Connect up to two sensors via digital or analog inputs
- Stores approximately 20,000 data points for each connected sensor
- Prognosys™ predictive diagnostics provide health and maintenance alerts for the controller and connected sensors
- USB port for data download and software upload

INCLUDES

SC4500 controller and mounting hardware. Certain models also include a US plug, 1-year warranty.

SPECIFICATIONS

COMMUNICATION	Analog: Five 0 to 20 mA or 4 to 20 mA Outputs on Each Analog Module Digital: Profibus DPV1 Module Modbus TCP Profinet IO Module Ethernet IP Module
COMPATIBLE PROBES	All Hach SC sensors
DIMENSIONS	5.7" x 5.7" x 7.6"
DISPLAY	LCD Color Display with Capacitive Touchpad
INPUTS	Two Digital SC Inputs or Up to Two Analog Input Modules (Each Analog Input Replaces a Digital Input)
NETWORK CONNECTIVITY	LAN, Cellular or Wi-Fi
POWER REQUIREMENTS	AC Controller: 100 to 240 VAC DC Controller: 24 VDC
RELAYS	Two Relays (SPDT)
STORAGE	Approximately 20,000 Data Points for Each Connected Sensor



CERTIFICATIONS

- Compliant with US EPA 40 CFR 141.74
- EPA CSA and UL certified

C&M PART #	MFG PART #	POWER	US PLUG INCLUDED	INPUT 1	INPUT 2
704084	LXV525.99A11501	100 to 240 VAC	No	Digital	None
704106	LXV525.99E11501	100 to 240 VAC	Yes	Digital	None
704180	LXV525.99Z11501	24 VDC	No	Digital	None
704086	LXV525.99A11551	100 to 240 VAC	No	Digital	Digital
704108	LXV525.99E11551	100 to 240 VAC	Yes	Digital	Digital
704182	LXV525.99Z11551	24 VDC	No	Digital	Digital
704085	LXV525.99A11541	100 to 240 VAC	No	Digital	Analog (4 to 20 mA)
704107	LXV525.99E11541	100 to 240 VAC	Yes	Digital	Analog (4 to 20 mA)
704181	LXV525.99Z11541	24 VDC	No	Digital	Analog (4 to 20 mA)

REPLACEMENT PARTS & ACCESSORIES

C&M PART #	MFG PART #	DESCRIPTION
704221	LXZ524.97.00042	Analog mA Input Module (1 Input)
704213	LXZ525.99.D0002	Analog mA Output Module (5 Outputs)
704214	LXZ525.99.C0002	Ethernet IP Upgrade Kit
704215	LXZ525.99.C0003	Modbus TCP/IP Upgrade Kit
704216	LXZ524.99.00004	UV Protection Screen
704217	LXZ524.99.00005	UV Protection Screen with Sunroof
704218	LXZ524.99.00033	Sunroof Visor
704219	LXZ524.99.00036	Mounting Hardware Sunroof with Visor
704220	LXZ524.99.00037	Sunroof with Visor
702245	5448800	Power Cord Kit, 125 VAC



Hach SC1000 Controller

The Hach® SC1000 Multiparameter Universal Controller is a state-of-the-art modular transmitter system. Order a display module and at least one probe module for a complete controller. One display module controls one or more probe modules connected by a digital network. Easily disconnect and move the fully portable display module anywhere within the network. The display module features an intuitive, easy-to-use interface and large color touchscreen display for use with any number of parameters. Network together the probe modules to accommodate up to 32 digital sensors or analyzers.

The SC1000 controller features Modbus TCP/IP communications protocol for seamless integration into a network of devices that support TCP/IP sockets. Use a standard Ethernet cable or connect wirelessly using GSM/GPRS to communicate with your SCADA, PLC or other network. Prognosys™ predictive diagnostics uses innovative multivariable diagnostic software to read multiple inputs from the instrument and notifies you to the overall performance of the instrument. An easy-to-read dashboard provides instant indication of measurement reliability and service requirements.

FEATURES & BENEFITS

- A fully modular system—a display module and one or more probe modules
- Add additional probe module and associated sensors to a single display module
- Accommodate up to 32 sensors or analyzers
- Compatible with any Hach digital sensor—simply plug into a probe module to use
- Add or change probes without changing the controller
- Prognosys™ predictive diagnostics provide health and maintenance alerts for the controller and connected sensors

INCLUDES

SC1000 controller set-ups requires display module and at least one probe module; Display modules include display module with communication options (as indicated) and user manual; Probe modules include probe module with communication options (as indicated) and user manual; 1-year warranty

SPECIFICATIONS

COMMUNICATION	Analog: Up to 12 0 to 20 mA or 4 to 20 mA outputs Digital: Profibus DPV1 module Modbus TCP Ethernet IP module
COMPATIBLE PROBES	All Hach SC sensors
DIMENSIONS	Display Module: 7.9" x 9.0" x 2.0" Probe Module: 5.9" x 12.4" x 9.8"
DISPLAY	LCD Color Display with Touchpad
ENCLOSURE RATING	IP65
INPUTS	Digital: 4, 6, or 8 per Probe Module (Based on Model) Analog: Up to 12 per Probe Module (Based on Model)
POWER REQUIREMENTS	100 to 240 VAC
RELAYS	Four Relays (SPDT)



Please note that we have access to many other unit configurations. Contact us at 888-885-2673 for a full range of product offerings.

CERTIFICATIONS

- EPA, CSA and UL certified

DISPLAY MODULES

C&M PART #	MFG PART #	DESCRIPTION
703636	LXV402.99.00002	SC1000 Display Module
703637	LXV402.99.02002	SC1000 Display Module with GSM/PRS Communication
703638	LXV402.99.10002	SC1000 Display Module with Modbus TCP/IP Protocol
703639	LXV402.99.12002	SC1000 Display Module with Modbus TCP/IP and GSM/GPRS Protocols

PROBE MODULES

C&M PART #	MFG PART #	INPUTS	OUTPUTS	US PLUG INCLUDED
703629	LXV400.99.10172	4 Digital Probes	4 Analog (4 to 20 mA)	No
703627	LXV400.99.10082	6 Digital Probes	N/A	No
703628	LXV400.99.10092	8 Digital Probes	N/A	No
703634*	LXV400.99.5B522	4 Digital Probes, 4 Analog (4 to 20 mA)	4 Analog (4 to 20 mA), 4 Relays	Yes
703635*	LXV400.99.5B532	6 Digital Probes, 4 Analog (4 to 20 mA)	4 Analog (4 to 20 mA), 4 Relays	Yes

*Communication Protocol is Modbus

NETWORK AND COMMUNICATION CARDS

C&M PART #	MFG PART #	DESCRIPTION
704075	YAB021	SC1000 Internal Modbus RS485 Card
704077	YAB103	SC1000 Internal Profibus DP Module
704076	YAB076	SC1000 Internal Relay Card
704073	YAB018	SC1000 Internal 0/4 to 20 mA Analog/Digital Inputs Card
704074	YAB019	SC1000 Internal 0/4 to 20 mA Analog/Digital Outputs Card
703852	LZX918	SC1000 Internal Network Connector

Continued on Next Page

Hach SC1000 Controller *(continued)*

REPLACEMENT PARTS & ACCESSORIES

C&M PART #	MFG PART #	DESCRIPTION
702316	6169900	SC1000 Panel Mount Kit
703856	LZX958	SC1000 Sun Shield
703858	LZY488	SC1000 Bus Cable for Flexible Installations (per Foot)
702245	5448800	North American Power Cord Kit with Strain Relief, 125 VAC
702464	9218100	SD Memory Card, 4 GB
702465	9218200	SD Card Reader
703851	LZX915	External DIN Rail Base Module
703853	LZX919	External DIN Rail Output Module, 2 Analog (4 to 20 mA)
703854	LZX920	External DIN Rail Output Module, 4 SPDT Relays
703855	LZX921	External DIN Rail Input Module, 4 Analog (4 to 20 mA)



Helpful Tip: Tips on Choosing the Right Controller

Choosing the correct controller is critical when setting up process control analyzers. It is helpful to consider the following criteria when determining which controller to use:

- What type of inputs will you have going to the controller?
Will it be digital inputs or analog (0/4-20 mA) inputs?
- How many inputs will you have going to the controller?
- What type of outputs will you need coming out of the controller?
- How many outputs will you have coming out of the controller?
- Do you need the outputs to help drive SCADA/PLC activities?
- Where will the controller be mounted?
 - Will the controller be indoors or outdoors?
 - Are there any special environmental hazards that need to be taken into account?
- Do you have any dimension or size restraints at the desired mounting location? Verify the controller will fit where you want to install it.

Contact us at **888-885-2673** if you have any questions or need help identifying the best controller for your application.

COMPATIBLE PROBES & SENSORS



See our selection of **pH/ORP Analyzers & Accessories** on **pages 274-275** for compatible probes and sensors.

Hach PRO Series Transmitters



704012

Use the easy-to-use, economical Hach® PRO Series Transmitters to measure pH, ORP or conductivity. Transmitters feature a simple keypad and logical menu structure that guide you through setup, calibration, operation and test/maintenance functions.

Easily wire transmitters in two-, three-, or four-wire hookup arrangements to meet application requirements. Set isolated analog output to 0 to 20 mA or 4 to 20 mA, and assigned to represent the measurement parameter or temperature. During calibration, the output is automatically held at the last measured value and returned to its active state upon completion.

The passcode capability restricts access to configuration settings and calibration to authorized personnel for added security. The NEMA 4X enclosure can be panel, wall, pipe or integral sensor mounted. The interface is identical to GLI's 33 series analyzers.

FEATURES & BENEFITS

- Measure pH, ORP or conductivity—simply select a compatible probe
- Easy to use with menu-guided interface
- Versatile 2-, 3- or 4-wire hookup capability
- Isolated analog (0/4 to 20 mA) output
- Panel, wall, pipe or integral sensor mount NEMA 4X enclosure
- Passcode protection for added security

INCLUDES

Controller and user manual. 1-year warranty

SPECIFICATIONS

COMMUNICATION	Analog (0/4 to 20 mA) Output
COMPATIBLE PROBES	Analog pH, ORP or Conductivity Sensors
DIMENSIONS	3.7" x 3.7" x 2.4"
DISPLAY	2-Line by 16-Character LCD
ENCLOSURE	NEMA 4X
INPUTS	1 Analog Sensor
POWER REQUIREMENTS	24 VDC

CERTIFICATIONS

- EPA, CSA and UL certified

C&M PART #	MFG PART #	DESCRIPTION
704012	PRO-P3AIN	PRO Series Transmitter, pH/ORP
704008	PRO-C3AIN	PRO Series Transmitter, Contacting Conductivity
704010	PRO-E3AIN	PRO Series Transmitter, Contactless Conductivity

Hach CA610 Fluoride Analyzer



The Hach® CA610 Fluoride Analyzer uses advanced ion-selective electrode (ISE) technology for continuous monitoring of fluoride concentration in drinking water effluent. The ISE system of the CA610 analyzer includes a reference pH electrode and a working electrode. The service life of the working electrode is approximately one year; replace the specially designed tip of the electrode every six months. Electrodes feature BNC connectors so that they can be independently checked with laboratory electrochemical meters.

Ensure accuracy with precise control of temperature, ionic strength and pH. The analyzer uses three reagents: Total Ionic Strength Adjustment Buffer (TISAB) solution and two fluoride standards. The ionic strength adjustment ensures that interferences that can bias measurements are virtually eliminated and lets the electrode respond to concentration instead of activity. The two standards are used when the instrument performs a two-point calibration at 0.5 and 5.0 mg/L fluoride at user-selected time intervals; set automatic calibration intervals from 1 day to 1 month. Store readings and calculations of the most recent calibration in the instrument. Reagent consumption is very low and maintenance is simple. One unit of each standard solution is sufficient for two months operation at a 24-hour calibration interval, and one unit of TISAB (Reagent 1) is sufficient for a 30-day operating period. Use the analog (0/4 to 20 mA) output to send results to a recorder.

FEATURES & BENEFITS

- Reliable, full-time fluoride monitoring from 0.1 to 10 mg/L
- Accurate measurements ensured via ISE technology paired with TISAB addition
- Two-point calibration with customizable time intervals
- Low reagent consumption and simple maintenance
- Analog (0/4 to 20 mA) output ensures that results can be recorded

INCLUDES

CA610 fluoride analyzer, one-month supply of reagents, wall-mounting installation kit, maintenance kit and user manual; 1-year warranty

SPECIFICATIONS

RANGE	0.1 to 10 mg/L Fluoride
ACCURACY	±10% or 0.10 mg/L, Whichever is Greater
MINIMUM DETECTION LIMIT	0.10 mg/L
CYCLE TIME	4.2 Minutes
SAMPLE INLET PRESSURE	1 to 10 PSIG
SAMPLE FLOW RATE	200 to 500 mL/minute
OPERATING TEMPERATURE	41 to 104°F
POWER REQUIREMENT	100 to 115/230 VAC, 50/60 Hz
DISPLAY	LCD
COMMUNICATION	1 Analog (0/4 to 20 mA) Output
DIMENSIONS	13.5" x 16.5" x 7.5"
RELAYS	2 SPDT Relays
ENCLOSURE	IP62 Molded ABS Plastic

CERTIFICATIONS

- CSA & UL certified

ANALYZER

C&M PART #	MFG PART #	DESCRIPTION
702261	5740001	CA610 Fluoride Analyzer with Reagents

REPLACEMENT REAGENTS

C&M PART #	MFG PART #	DESCRIPTION
701947	2816900	CA610 Reagent Set (Includes TISAB, Standard 1, & Standard 2)
701944	2812811	Reagent 1 TISAB, 473 mL
701872	2743811	Standard 1, 0.5 mg/L as Fluoride, 473 mL
701924	2797111	Standard 2, 5.0 mg/L as Fluoride, 473 mL
702084	4450126	Inner Fill Solution for Fluoride Half-Cell Electrode, 50 mL

REPLACEMENT PARTS & ACCESSORIES

C&M PART #	MFG PART #	DESCRIPTION
702262	5742100	Maintenance Kit (Includes Instrument and Pump Tubing Sets, Replacement Filter Screen and Spare Fittings).
702266	5744400	Pump Tubing Set
702267	5744800	Electrode Kit (Includes ISE and pH Electrodes, Electrode Tips, Syringe and Inner Fill Solution).
702245	5448800	Power Cord, 125 VAC, 6 ft
702102	4643600	Flow Meter with 1/4" OD Tubing



Hach SP510 Hardness Monitor

The Hach® SP510 Hardness Monitor quickly, reliably and accurately detects hardness breakthrough when the capacity of a water softener is exhausted, immediately signaling the need for regeneration. The monitor samples water every two minutes, operating automatically for up to 60 days. It is virtually maintenance free, requiring only about 15 minutes every two months to replenish the reagents. Replace tubing in the pump system every six months.



Alarm point is 2 ppm (expressed as mg/L of CaCO₃) and is selected by choosing the appropriate model. A rugged, corrosion-resistant and shatterproof ABS plastic case protects the analyzer and reagents. The sealed case is IP62-rated and has a hinged door for easy access to internal components. Easy-to-read LED indicators show a simple "HARD" or "SOFT" sample status. Use the built-in alarm relay to actuate an external annunciator.

FEATURES & BENEFITS

- Reliable, simple and accurate hardness monitor with automated calibration
- Monitor hardness at preset alarm point of 2 mg/L of CaCO₃
- Low-maintenance operation requires minimal reagent replenishment and tubing replacement
- Makes your water softening system more efficient and less costly

INCLUDES

SP510 Hardness Monitor, two month's supply of reagents, installation kit, maintenance kit (stirring bar, strainer, spare tube assemblies, shut-off valve) and user manual; 1-year warranty

SPECIFICATIONS

RANGE	2 mg/L of CaCO ₃
ACCURACY	±25% of Set Point Value
CYCLE TIME	1.9 Minutes
SAMPLE INLET PRESSURE	1.5 to 75 PSIG
SAMPLE FLOW RATE	50 to 500 mL/min
OPERATING TEMPERATURE	32 to 104°F
POWER REQUIREMENT	115 VAC
DIMENSIONS	16.5" x 12.5" x 7"
RELAYS	1 SPDT Relay for External Annunciator
ENCLOSURE	IP62

CERTIFICATIONS

- UL & CSA and CE approved

C&M PART #	MFG PART #	DESCRIPTION
702208	5410002	SP510 Hardness Monitor, 2 mg/L Trip Point

Contact us at **888-885-2673** if you need to monitor hardness levels other than 2 mg/L.

REPLACEMENT PARTS & ACCESSORIES

C&M PART #	MFG PART #	DESCRIPTION
701905	2768549	Buffer for 0.3, 1, 2 or 5 mg/L
701906	2768649	Buffer for 10 mg/L
701907	2768749	Buffer for 20 mg/L
701908	2769049	Indicator for 1 mg/L
701909	2769149	Indicator for 2 mg/L
701910	2769249	Indicator for 5, 10, 20, 50 or 100 mg/L

Hach pH Buffers

These NIST-traceable pH buffers ensure accuracy of ±0.02 pH units at 25°C. Select from different colors and sizes.

C&M PART #	MFG PART #	pH	BUFFER TYPE	COLOR	QUANTITY
700063	2283449	4.01	Solution	Red	500 mL
700064	2283456	4.01	Solution	Red	4 L
700065	2283461	4.01	Solution	Red	20 L
700066	1222349	4.01	Solution	Colorless	500 mL
700067	1222356	4.01	Solution	Colorless	4 L
700068	2283549	7.00	Solution	Yellow	500 mL
700069	2283556	7.00	Solution	Yellow	4 L
700070	2283561	7.00	Solution	Yellow	20 L
700071	1222249	7.00	Solution	Colorless	500 mL
700072	1222256	7.00	Solution	Colorless	4 L
700073	2283649	10.01	Solution	Blue	500 mL
700074	2283656	10.01	Solution	Blue	4 L



C&M PART #	MFG PART #	pH	BUFFER TYPE	COLOR	QUANTITY
700075	2283661	10.01	Solution	Blue	20 L
700076	1222149	10.01	Solution	Colorless	500 mL
700077	1222156	10.01	Solution	Colorless	4 L
700079	2507200	4.01, 7.00, 10.01	Solution	Red, Yellow, Blue	4 L
700078	2947600	4.01, 7.00, 10.01	Solution	Red, Yellow, Blue	500 mL
700080	2507300	4.01, 7.00, 10.01	Solution	Red, Yellow, Blue	20 L

Hach Differential pH & ORP Sensors



Obtain unsurpassed measurement accuracy, reduced reference junction potential and elimination of sensor ground loops using Hach® differential pH & ORP sensors. These sensors use three electrodes, process, reference and ground, instead of only two electrodes to measure the differential pH/ORP.

These process pH/ORP sensors provide excellent reliability, resulting in less downtime and maintenance. They feature a double-junction salt bridge that creates a barrier to contamination which minimizes the dilution of the internal standard cell solution, resulting in a longer time period between calibrations. Plus, the unique salt bridge is replaceable and simply threads onto the ends of the sensor if replacement is needed.

The sensors are available in PEEK or PPS body materials; select sensors with PEEK body for use with harsh chemicals. Sensors feature 1" NPT(M) threads for in-line or submersion mounting. Differential pH & ORP sensors are available in digital and analog configurations.

FEATURES & BENEFITS

- Three electrodes in the sensors increase accuracy and eliminate sensor ground loops
- Available in PEEK or PPS (Ryton®) body materials
- Replaceable salt bridge extends working life of the sensor by protecting reference electrode
- Transmit signals up to 1000 ft
- Available in digital or analog configurations

INCLUDES

All digital sensors include built-in digital electronics and integral 33-ft cable terminated with connector for the Hach SC digital controllers; All analog sensors include built-in preamplifier and integral 15-ft cable terminated with stripped and tinned wires; 1-year warranty

SPECIFICATIONS

RANGE	pH: -2.0 to 14.0 ORP: -1500 to +1500 mV
SENSITIVITY	±0.01 pH; ±0.5 mV
FLOW RATE (MAX)	10 ft/sec
OPERATING TEMPERATURE	23 to 158°F

C&M PART #	MFG PART #	DESCRIPTION	MATERIAL	CABLE LENGTH
GENERAL-PURPOSE DIGITAL DIFFERENTIAL SENSORS				
703343	DPD1P1	pH Sensor	PEEK	33 ft
703348	DPDIR1	pH Sensor	PPS	33 ft
703352	DPD2P1	pH Sensor, Insertion Mount	PEEK	33 ft
703356	DPS1	pH Sensor	Stainless Steel	33 ft
703371	DRD1P5	ORP Sensor	PEEK	33 ft
703375	DRDIR5	ORP Sensor	PPS	33 ft
703378	DRD2P5	ORP Sensor, Insertion Mount	PEEK	33 ft
703382	DRS5	ORP Sensor	Stainless Steel	33 ft
GENERAL-PURPOSE ANALOG DIFFERENTIAL SENSORS				
703966	PDIP1	pH Sensor	PEEK	15 ft
703972	PDIPA33	pH Sensor	PEEK	33 ft
703978	PDIR1	pH Sensor	PPS	15 ft
704016	RDIP5	ORP Sensor	PEEK	15 ft
704022	RDIR5	ORP Sensor	PPS	15 ft

REPLACEMENT PARTS & ACCESSORIES

C&M PART #	MFG PART #	DESCRIPTION
FOR DIGITAL SENSORS		
702254	5646300	Insertion Mounting, Digital, 1-1/2" CPVC
702271	5796000	Digital Extension Cable, 7.7 m (25 ft)
702273	5796100	Digital Extension Cable, 15 m (50 ft)
702275	5796200	Digital Extension Cable, 30 m (100 ft)
702305	6120500	GLI pH/D, Digital Gateway
702306	6120600	PC/RC Combination Digital Gateway
702315	6136400	Mounting Kit for Digital pH Sensor
FOR ANALOG SENSORS		
702662	1W1100	Analog Interconnect Extension Cable
702990	60A2053	Junction Box, Surface-Mount, Aluminum
703912	MH434A00B	CPVC Submersion Hardware
FOR DIGITAL & ANALOG DIFFERENTIAL SENSORS		
702312	6131300	CPVC Union Mount for pH Sensor
702327	7300800	Flow Cell for 1" NPT Sensor
702612	1000F3374-003	1" Sensor Guard, PPS
702699	25M1A1001-115	GLI pH 7.0 Buffer, Standard Cell 500 mL
702700	25M1A1001-123	GLI pH 7.0 Buffer, Standard Cell 3.5 L
702704	25M1A1025-115	Replacement Standard Cell Solution, 500 mL
702705	25M2A1001-115	200 mV ORP Solution, 500 mL
702706	25M2A1001-119	200 mV ORP Solution, 1 L
702707	25M2A1001-123	200 mV ORP Solution, 3.5L
702708	25M2A1002-115	600 mV ORP Reference Solution, 500 mL
702709	25M2A1002-119	600 mV ORP Reference Solution, 1 L
702710	25M2A1002-123	600 mV ORP Reference Solution, 3.5L
703892	MH116M3MZ	SS Insertion Mounting Hardware
703896	MH236B00Z	CPVC Immersion Handrail Mounting Hardware for pH Sensors, 1"
703911	MH432G	CPVC Pipe Mount with Junction Box
704049	SB-P1SV	Salt Bridge for PEEK Sensor, PVDF Junction
704051	SB-R1SV	Salt Bridge for PPS Sensor, PVDF Junction

Hach LCP Differential pH & ORP Sensors



Hach® Liquid Crystal Polymer (LCP) Differential electrodes utilize three electrodes instead of the two for unsurpassed measurement accuracy, reduced reference junction potential and elimination of sensor ground loops. Process and reference electrodes measure the pH/ORP differentially with respect to a third ground electrode.

These process pH/ORP sensors provide excellent reliability, resulting in less downtime and maintenance. They feature a double-junction salt bridge that creates a barrier to contamination which minimizes the dilution of the internal standard cell solution, resulting in a longer time period between calibrations. Plus, the unique salt bridge is replaceable and simply threads onto the ends of the sensor if replacement is needed.

The durable LCP body withstands harsher conditions than standard differential pH and ORP sensors. Sensors feature 1.5" NPT(M) threads at both ends of the sensor for either mounting into a pipe tee or attaching to the end of a pipe for immersion. LCP differential sensors are only available in analog configurations.

FEATURES & BENEFITS

- Three electrodes increase accuracy and eliminate sensor ground loops
- LCP body handles extremely harsh conditions
- Transmit signals up to 3000 ft
- 1.5" NPT(M) threads on both ends for pipe-tee or immersion mounting
- Replaceable salt bridge extends working life of the sensor by protecting reference electrode

INCLUDES

Sensor with 5-wire, 10-ft cable and user manual; 1-year warranty

SPECIFICATIONS

RANGE	pH: 0 to 14 ORP: -2000 to +2000 mV
SENSITIVITY	±0.005 pH; ±0.5 mV
FLOW RATE (MAX)	10 ft/sec
OPERATING TEMPERATURE	23 to 203°F

C&M PART #	MFG PART #	DESCRIPTION	MATERIAL	CABLE LENGTH
CONVERTIBLE MOUNTING SENSORS				
702939	6028P0	pH	LCP	10 ft
702668	2028R0	ORP Sensor	LCP	10 ft

REPLACEMENT PARTS & ACCESSORIES

C&M PART #	MFG PART #	DESCRIPTION
702986	60-9765-000-001	LCP Replacement Salt Bridge
702699	25M1A1001-115	GLI pH 7.0 Buffer Standard Cell Solution, 500 mL
702992	60A2F1278	LCP pH/ORP Sensor Protector (Bulb Protector)

Hach Combination pH & ORP Sensors



703954

703959

These Combination pH and ORP Sensors are perfect when expensive differential sensor is not required. The PC-series (for pH) and RC-series (for ORP) combination sensors are ideal for measuring mild and aggressive media. The reference cell features a double-junction for extended service life and a built-in solution ground. The body is molded from chemically-resistant PPS (Ryton) and the reference junction is coaxial porous PTFE. Use the digital gateway to convert PC and RC sensors to digital output for connecting to Hach® SC controllers. Sensors are available with either round bulb electrodes or flat glass electrodes for easy cleaning.

FEATURES & BENEFITS

- Low price, high-quality performance for when differential sensors are not required
- Choose from round-bulb or flat-bulb sensor options
- Connect to Hach SC controllers

INCLUDES

Analog sensor have integral 4.5-ft cable with tinned leads and user manual; 3-month warranty

SPECIFICATIONS

RANGE	pH: 0 to 14 ORP: -2000 to +2000 mV
SENSITIVITY	±0.1 pH; ±20 mV
FLOW RATE (MAX)	6.6 ft/sec
OPERATING TEMPERATURE	32 to 221°F

C&M PART #	MFG PART #	DESCRIPTION	MATERIAL	CABLE LENGTH
COMBINATION PH & ORP SENSORS				
703954	PC1R1A	pH Sensor, Round Bulb	PPS	15 ft
703959	PC1R2A	pH Sensor, Flat Bulb	PPS	15 ft
704014	RC1R5N	ORP Sensor, Round Bulb	PPS	15 ft

REPLACEMENT PARTS & ACCESSORIES

C&M PART #	MFG PART #	DESCRIPTION
702306	6120600	Digital Gateway



Hach TU5 Series Online Laser Turbidimeter & Accessories



Pair with the TU5200 (C&M Part #703596) for comparable lab and process measurements!

Compliant with EPA-approved Hach® Method 10258 and perfect for conventional filtration and other low range turbidity measurements, the TU5 Series Turbidimeters employ a patented optical design that sees more of your sample than any other turbidimeter. For the first time you will be able to remove uncertainty of which measurement to trust between your lab and process instruments, thanks to identical 360° x 90° detection technology in any TU5 Series Turbidimeter.

These turbidimeters deliver the best low-level precision and sensitivity while minimizing variability between measurements, dramatically reducing the time needed to get a turbidity measurement you can rely on. Meters provide 98% less online sample surface area to clean, sealed vials for calibration, and the elimination of the need for indexing and silicone oil in the lab. A smaller online sample volume means you will detect events almost immediately.

The Prognosys™ diagnostics system monitors your TU5 Series online instrument, proactively alerting you to maintenance needs before your measurement becomes questionable. And a Hach Service Agreement protects your investment and helps ensure that you stay in compliance and on budget.

FEATURES & BENEFITS

- A patented optical design offers the best low-level precision and sensitivity while minimizing variability from test to test
- The 360° x 90° detection technology removes any uncertainty in the measurement
- Prognosys™ diagnostics system proactively alerts you to maintenance needs

INCLUDES

Wall mount, vial replacement tool, screw set, drying cartridge, flow regulator, service bracket and user manual

SPECIFICATIONS

RANGE	0 to 700 NTU / FNU / FTU
ACCURACY	±2% of reading plus 0.01 NTU (up to 40 NTU), ±10% of Reading (over 40 NTU)
RESOLUTION	0.0001 NTU, FNU and FTU
RESPONSE TIME	T90 <30 seconds at 100 mL/min
REPEATABILITY*	
TU5300SC	<1% of Reading or ±0.002 NTU, Whichever is Greater
TU5400SC	<1% of Reading or ±0.0006 NTU, Whichever is Greater
SAMPLE FLOW RATE	100 to 1000 mL/min (1.6 to 15.9 gal/hr) Optimal: 200 to 500 mL/min (3.2 to 7.9 gal/hr)
OUTPUTS	Varies Based on Connected Controller
POWER	Supplied by Controller via Included Cable
CABLE	5-ft L Integral Digital Type (Extensions Available)
ENCLOSURE	Indoor Flat Surface Mount (Bracket Included), 10.6"W x 7.5"H x 9.8"D

CERTIFICATIONS

- EPA Compliant

C&M PART #	MFG PART #	DESCRIPTION
ULTRA-LOW RANGE TU5300SC TURBIDIMETERS		
703643	LXV445.99.10112	Standard
703645	LXV445.99.11112	System Check
703648	LXV445.99.13112	System Check & RFID
703651	LXV445.99.21112	Flow Sensor & System Check
703653	LXV445.99.23112	Flow Sensor, System Check & RFID
703655	LXV445.99.33112	Automatic Cleaning, System Check & RFID
703658	LXV445.99.53112	Flow Sensor, Automatic Cleaning, System Check & RFID
ULTRA-HIGH PRECISION LOW RANGE TU5400SC TURBIDIMETERS		
703644	LXV445.99.10212	Standard
703649	LXV445.99.13212	System Check & RFID
SC4500 CONTROLLERS WITH PROGNOSYS DIAGNOSTICS		
704084	LXV525.99A11501	Five mA Outputs and 1 Digital Sensor, without Plug, 100 to 240 VAC
704086	LXV525.99A11551	Five mA Outputs and 2 Digital Sensors, without Plug, 100 to 240 VAC
704106	LXV525.99E11501	Five mA Outputs and 1 Digital Sensor, with US Plug, 100 to 240 VAC
704108	LXV525.99E11551	Five mA Outputs and 2 Digital Sensors, with US Plug, 100 to 240 VAC
704182	LXV525.99Z11551	Five mA Outputs and 2 Digital Sensors, without Plug, 24 VDC
COMPLETE SYSTEMS		
704081	LXV525.97KTO036	TU5300sc Turbidimeter Standard plus SC4500 Controller with Dual Inputs
704080	LXV525.97KTO040	TU5300sc Turbidimeter with Flow Sensor, System Check & RFID plus SC4500 Controller with Dual Inputs
704079	LXV525.97KTO037	TU5300sc Turbidimeter with Flow Sensor, Automatic Cleaning, System Check & RFID plus SC4500 Controller with Dual Inputs

Continued on Next Page



Hach TU5 Series Online Laser Turbidimeter & Accessories (continued)

REPLACEMENT PARTS & ACCESSORIES

C&M PART #	MFG PART #	DESCRIPTION
RECOMMENDED ACCESSORIES		
703616	LQV159.97.00002	Automatic Cleaning Module TU5
703617	LQV160.99.00002	Flow Sensor for TU5300sc and TU5400sc Laser Turbidimeters
CALIBRATION SOLUTIONS & ACCESSORIES		
703863	LZY835	Stabcal® Calibration Set with RFID
703870	LZY898	Stabcal® Calibration Set without RFID
703873	LZY901	Glass Rod Secondary Turbidity Standard <0.1 NTU
703875	LZY904.97.00002	Calibration Lid for TU5300sc and TU5400sc Turbidimeters
MAINTENANCE KITS & ACCESSORIES		
703866	LZY873	Service Bracket for TU5300sc and TU5400sc Laser Turbidimeters
703874	LZY903	Manual Vial Wiper for TU5300sc and TU5400sc Laser Turbidimeters
703877	LZY907.97.00002	Maintenance Case TU5
703878	LZY910	Vial Compartment Wiper for TU5300sc and TU5400sc, 10/PK
703880	LZY915	Silicone Wiper, Cleaning, TU5 Series
703882	LZY945	Microfiber Cloth

C&M PART #	MFG PART #	DESCRIPTION
REPLACEMENT ITEMS & ACCESSORIES		
702271	5796000	Digital Extension Cable, 7.7 m (25 ft)
702310	6122400	Digital Extension Cable, 1 m (3.3 ft)
703862	LZY834	Replacement Process Sample Vial
703867	LZY876	Replacement Desiccant Drying Cartridge
703876	LZY906	Vial Removal Tool
1113161811BC	0125-0250-062-11-03-00050	LLDPE Standard Tubing, Translucent, 1/4" OD x 1/8" ID, 358 PSI, 50-ft L
RFID TAGS		
703728	LZQ066	Operator RFID Tag, 2/PK
703729	LZQ067	Sample RFID Tag, Black, 3/PK
703730	LZQ068	Sample RFID Tag, Yellow, 3/PK
703731	LZQ069	Sample RFID Tag, Red, 3/PK
703732	LZQ070	Sample RFID Tag, Blue, 3/PK
703733	LZQ071	Sample RFID Tag, Green, 3/PK
703734	LZQ072	Sample Location RFID Tag, 5/PK

Hach StabCal® Turbidity Standards

StabCal® Stabilized Formazin Turbidity Standards are true Formazin dilutions developed for use in any turbidimeter. Precise, premixed solutions require NO dilution and are ready for use.



CALIBRATION KITS

C&M PART #	MFG PART #	NTU VALUE	SIZE
702016	2971205	20, 100, 800 for Calibration; 10 for Verification	Sealed Vials
701789	2659405	<0.1, 20, 100, 800	Sealed Vials
701790	2659410	<0.1, 20, 100, 800	100-mL Bottle
701788	2659400	<0.1, 20, 100, 800	500-mL Bottle
701817	2662105	<0.1, 20, 200, 1000, 4000	Sealed Vials
701818	2662110	<0.1, 20, 200, 1000, 4000	100-mL Bottle
701816	2662100	<0.1, 20, 200, 1000, 4000	500-mL Bottle
701792	2659505	<0.1, 20, 200, 1000, 4000, 7500	Sealed Vials
701793	2659510	<0.1, 20, 200, 1000, 4000, 7500	100-mL Bottle
701791	2659500	<0.1, 20, 200, 1000, 4000, 7500	500-mL Bottle
701861	2714600	0.1, 0.3, 0.5, 1.0	100-mL Bottle

GELEX SECONDARY STANDARDS

C&M PART #	MFG PART #	NTU VALUE	SIZE
701624	2464105	0 to 10, 10 to 100, 100 to 1000	Sealed Vials
701708	2589000	0 to 2, 0 to 20, 0 to 200, 200 to 4000	Sealed Vials
701715	2589200	0 to 2, 0 to 20, 0 to 200, 200 to 4000, 4000 to 10,000	Sealed Vials

PRIMARY STANDARDS

C&M PART #	MFG PART #	NTU VALUE	SIZE
701705	2584202	7500	Sealed Vial
701795	2659742	<0.1	100-mL Bottle
701863	2723342	0.1	100-mL Bottle
701848	2697942	0.3	100-mL Bottle
701850	2698042	0.5	100-mL Bottle
701799	2659842	1	100-mL Bottle
701803	2659942	10	100-mL Bottle
701805	2660142	20	100-mL Bottle
701808	2660242	100	100-mL Bottle
701810	2660442	200	100-mL Bottle
701812	2660542	800	100-mL Bottle
701814	2660642	1000	100-mL Bottle
700883	246142	4000	100-mL Bottle
701796	2659749	<0.1	500-mL Bottle
701800	2659849	1	500-mL Bottle
701804	2659949	10	500-mL Bottle
701806	2660149	20	500-mL Bottle
701809	2660249	100	500-mL Bottle
701811	2660449	200	500-mL Bottle
701813	2660549	800	500-mL Bottle
701815	2660649	1000	500-mL Bottle
700884	246149	4000	500-mL Bottle
701797	2659753	<0.1	1-L Bottle
701864	2723353	0.1	1-L Bottle
701849	2697953	0.3	1-L Bottle
701916	2788453	0.8	1-L Bottle
701801	2659853	1	1-L Bottle
701807	2660153	20	1-L Bottle
701881	2746353	40	1-L Bottle
701882	2746356	40	1-Gallon Bottle

Hach LDO Model 2 Probe



The Hach® LDO (Luminescent Dissolved Oxygen) Model 2 Probe accurately measures dissolved oxygen levels in water by utilizing luminescent dissolved oxygen technology within the oxygen sensor cap ensuring high levels of accuracy. Use the probe right out of the box—no calibration is required for the life of the sensor cap.

Monitor dissolved oxygen levels in your water applications and save time and money through minimum maintenance (no electrolyte solution) and overall reduction in aeration blower energy usage. An improved body design optimizes the probe's temperature sensor to provide an even faster response time to process variability as well.

The Prognosys™ diagnostic system allows proactive maintenance procedure by alerting you to upcoming instrument issues. Know with confidence whether changes in your dissolved oxygen level measurements are due to changes in your instrument or your water. Set customizable diagnostic alert indicators to ensure the probe operates at its maximum performance level. Select from various mounting options—rail mount, float mount, air blast system mount, chain mount, or union mount—to meet your application needs.

FEATURES & BENEFITS

- LDO Model 2 probe uses luminescent dissolved oxygen technology
- All probes are factory calibrated and ready-to-use out of the box
- Minimal maintenance—no membranes, electrolyte solution and anode or cathode
- Customizable service indicators trigger a service
- Multiple mounting options
- Compatible with all Hach SC controllers

INCLUDES

LDO Model 2 probe ready-to-use, calibration bags and user manual; Probe comes with 3-year warranty; Sensor cap has 2-year warranty

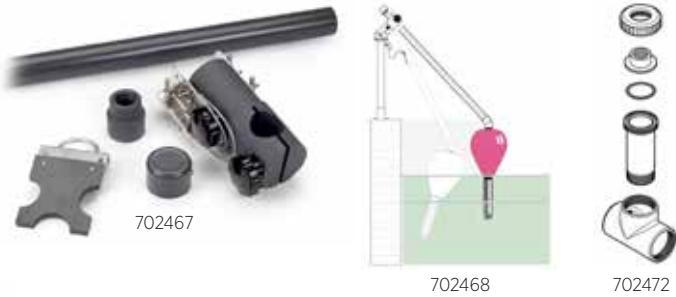

SPECIFICATIONS

RANGE	0 to 20.00 ppm (0 to 20.00 mg/L) 0 to 200% saturation
ACCURACY	± 0.05 ppm below 5 ppm ± 0.1 ppm above 5 ppm
RESOLUTION	ppm (mg/L) 0.1% saturation
CABLE LENGTH	31 ft
FLOW RATE	None Required
TEMPERATURE COMPENSATION	Automatic
COMPATIBLE CONTROLLERS	SC200, SC4500, SC1000
WETTED MATERIALS	Probe: CPVC, Polyurethane, FKM/FPM, Noryl, 316 Stainless Steel Sensor Cap: Acrylic

LDO MODEL 2 PROBES

C&M PART #	MFG PART #	DESCRIPTION
702435	9020000	LDO Model 2 Dissolved Oxygen Probe
703073	9020000-UPGRADE	LDO Model 2 Dissolved Oxygen Probe with Mounting Conversion Adapter

LDO MODEL 2 MOUNTING KITS

C&M PART #	MFG PART #	DESCRIPTION
702467	9253000	Pole Mount Kit, PVC
702468	9253100	Ball Float Mount Kit, PVC
702472	9257000	Union Mount Kit, PVC
702469	9253400	Mounting Conversion Adapter, LDO Model 1 to LDO Model 2
702327	7300800	1" NPT Sensor Flow Cell

REPLACEMENT PARTS & ACCESSORIES

C&M PART #	MFG PART #	DESCRIPTION
702436	9021100	LDO Model 2 Sensor Cap Replacement Kit
702301	5867000	Digital Termination Box
702271	5796000	Digital Extension Cable, 25 ft
702273	5796100	Digital Extension Cable, 50 ft
702275	5796200	Digital Extension Cable, 100 ft

Hach Chlorine DR300 Pocket Colorimeters

The Hach® Chlorine DR300™ Pocket Colorimeter™ maintains Hach's legacy of reliable chlorine testing for drinking water and wastewater applications while providing state-of-the-art features. Meters are available in Low-Range/High-Range (LR/HR) and Mid-Range/High-Range (MR/HR) concentrations.



FEATURES & BENEFITS

- Accurately measure free and total chlorine using US EPA accepted methods
- Rugged, waterproof design withstands any conditions encountered in the field, plant or lab
- Simple, intuitive operation reduces potential for user error
- Easily view measurements on the large, backlit display
- Compact size—easily fits in your pocket
- Store and recall last 50 measurements
- Battery life lasts for up to 5000 tests

INCLUDES

DR300 colorimeter, batteries, two glass 10 mL sample cells, two plastic high-range 10 mL sample cells, operating manual and storage case. One-year warranty.

SPECIFICATIONS

PARAMETER	Chlorine
METHOD	DPD
LR/HR RANGE (mg/L)	0.02 to 2.00 (LR); 0.1 to 8.0 (HR)
MR/HR RANGE (mg/L)	0.05 to 4.00 (MR); 0.1 to 10.0 (HR)
SAMPLE SIZE (mL)	10
BATTERY LIFE	Up to 5000 tests
BATTERY TYPE	Four "AAA" alkaline batteries

CERTIFICATIONS

- EPA Compliant, IP67

C&M PART #	MFG PART #	DESCRIPTION	# TESTS
DR300 CHLORINE POCKET COLORIMETERS			
700013	LPV445.97.00110	DR300 LR/HR Chlorine Colorimeter	-
700022	LPV445.97.62110	DR300 MR/HR Chlorine Colorimeter	-
REAGENTS & STANDARDS FOR DR300 LR/HR CHLORINE POCKET COLORIMETER			
700014012IN8	2105569	Powder Pillows, DPD (Free), 10 mL Sample	100
700014032IN8	2105528	Powder Pillows, DPD (Free), 10 mL Sample	1000
7000140122N8	2105669	Powder Pillows, DPD (Total), 10 mL Sample	100
7000140322N8	2105628	Powder Pillows, DPD (Total), 10 mL Sample	1000
700018	2802300	SwifTest Dispenser, DPD (Free), 10 mL Sample	250
700019	2802400	SwifTest Dispenser, DPD (Total), 10 mL Sample	250
700020	2635300	SpecCheck™ Secondary Chlorine Standards LR (0 to 2.0 mg/L)	-
700021	2893300	SpecCheck™ Secondary Chlorine Standards HR (0 to 8.0 mg/L)	-
REAGENTS & STANDARDS FOR DR300 MR/HR CHLORINE POCKET COLORIMETER			
7000140121X2	1407099	Powder Pillows, DPD (Free), 25 mL Sample	100
7000140122X2	1406499	Powder Pillows, DPD (Total), 25 mL Sample	100
700025	2980500	SpecCheck™ Secondary Chlorine Standards MR (0 to 4.0 mg/L)	-
700021	2893300	SpecCheck™ Secondary Chlorine Standards HR (0 to 8.0 mg/L)	-

REPLACEMENT PARTS & ACCESSORIES

C&M PART #	MFG PART #	DESCRIPTION
700026	2105560	SwifTest Refill Vial, DPD (Free), 10 mL Sample
700027	2105660	SwifTest Refill Vial, DPD (Total), 10 mL Sample
700624	34332	Potassium Iodide Solution, 100 mL
700725	104732	Sodium Arsenite Solution, 100 mL
700028	2427606	Glass Sample Cells, 10 mL, Pack of 6
700029	4864302	Plastic High-Range Sample Cells, 10 mL, Pack of 2

GET YOUR FREE CORE & MAIN LAB ESSENTIALS CATALOG

We stock thousands of laboratory items for same-day shipping to meet all your reagent, meter and equipment needs.

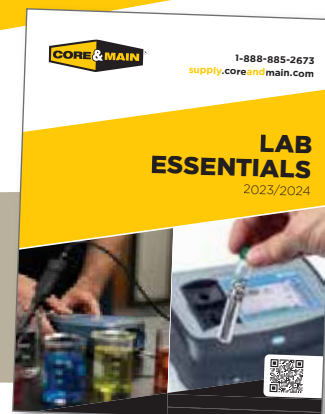

Hach SL1000 Portable Parallel Analyzers



The Hach® SL1000™ Portable Parallel Analyzer (PPA®) combines a colorimeter and an electrochemical multiparameter analyzer in one unit for faster, more accurate water analysis. Test up to six parameters, four colorimetric and two probe-based, simultaneously using Chemkey Reagents and IntelliCAL Probes. Automated steps and internal temperature control reduce inconsistent results due to manual operations and provide consistent, repeatable results every time. Chemkey reagents execute the same process steps that you have trusted for decades—now delivered in a simple, self-contained package. Simply insert the Chemkey(s) and let the SL1000 PPA run the test.

Colorimetric tests (Chemkey) include: monochloramine, free and total ammonia, free and total chlorine, nitrite, copper, high- and low-range orthophosphate, high- and low-range hardness, high- and low-range alkalinity, dissolved iron and peracetic acid

Probe-based tests include: pH, conductivity, ORP, dissolved oxygen, nitrate and fluoride

FEATURES & BENEFITS

- Measure six parameters at the same time—75% faster than with other methods
- No powder pillows or glass vials to handle—all chemicals and processes are entirely contained inside the Chemkeys
- Hach IntelliCAL smart probes retain calibration data minimizing errors and setup time
- Kits available with IntelliCAL probes and Chemkey reagents

INCLUDES

Analyzer Only: SL1000 PPA, carrying case, one analyzer sample cup, two probe sample cups, rechargeable battery, battery charger, hand strap, USB cable and operating manual. One-year warranty; **Full Kit** includes everything for “Analyzer Only” plus: pH probe, conductivity probe, one box each of free chlorine, total chlorine, monochloramine, free ammonia and nitrite Chemkeys; **Nitrification Kit** includes everything for “Analyzer Only” plus: pH probe, nitrate probe, one box each of free chlorine, total chlorine, monochloramine, free ammonia and nitrite Chemkeys

SPECIFICATIONS

CHEMKEY SLOTS	4
INTELLICAL INPUT CHANNELS	2
DATA MEMORY	1000 Measured Values
BATTERY LIFE	Up to 200 Chemkey Tests
BATTERY TYPE	Rechargeable Lithium Ion Battery

CERTIFICATIONS

- IP67

C&M PART #	MFG PART #	DESCRIPTION	RANGE (mg/L)	TESTS
CHEMKEYS				
700108	8636100	Total Alkalinity, HR	200 to 700 CaCO ₃	25
700109	8636200	Total Alkalinity, LR	20 to 200 CaCO ₃	25
700110	9425200	Total Ammonia	0.05 to 1.50 NH ₃ -N	25
702510	9429500	Free Ammonia	0.05 to 0.50 NH ₃ -N	25
700111	9429600	Free Ammonia & Monochloramine	Free: 0.05 to 0.50 NH ₃ -N Monochloramine: 0.04 to 4.00 Cl ₂	25 Each
700112	8791900	Free/Total Ammonia & Monochloramine	Free: 0.05 to 0.50 NH ₃ -N Total: 0.05 to 1.50 NH ₃ -N Monochloramine: 0.04 to 4.00 Cl ₂	25 Each
700113	9429400	Monochloramine	0.04 to 4.00 Cl ₂	25
700114*	8499300	Free Chlorine	0.04 to 4.00 Cl ₂	300
700115*	9429000	Free Chlorine	0.04 to 4.00 Cl ₂	25
700116*	8499400	Total Chlorine	0.04 to 10.0 Cl ₂	300
700117*	9429100	Total Chlorine	0.04 to 10.0 Cl ₂	25
700118	9427900	Chlorine Verification	System Check	-
700119*	9429200	Copper	0.06 to 5.00 Cu	25
700121	8636300	Hardness, HR	90 to 750 CaCO ₃	25
700122	8636400	Hardness, LR	3 to 100 CaCO ₃	25
700120	8636000	Dissolved Iron	0.05 to 3.00 Fe	25
700123	9429300	Nitrite	0.005 to 0.600 NO ₂ -N	25
700124	8636500	Orthophosphate, HR	2.0 to 30.0 PO ₄	25
700125	8636600	Orthophosphate, LR	0.20 to 4.00 PO ₄	25
700126	8635200	Peracetic Acid	0.04 to 50.0 PAA	25
700127	9759000	pH	pH 6.3 to 9.0	25
702513	9436800	System Verification	System Check	-

*EPA Compliant Methods

C&M PART #	MFG PART #	DESCRIPTION
SL1000 ANALYZER & ANALYZER KITS		
700092	9430000	SL1000 Analyzer Only
700093	8499000	Full SL1000 PPA Kit
700094	25632200	Full SL1000 Nitrification Kit
INTELLICAL PROBES		
700040	PHC10101	Lab Gel-Filled pH Probe, 1-m Cable
700041	MTC10101	Lab Gel-Filled ORP Probe, 1-m Cable
700088	LD010101	Lab LDO Dissolved Oxygen Probe, 1-m Cable
700090	CDC40101	Lab Conductivity Probe, 1-m Cable

REPLACEMENT PARTS & ACCESSORIES

C&M PART #	MFG PART #	DESCRIPTION
702343	8497000	Replacement Power Supply (No Power Cord)
702445	9094900	Replacement Battery
702503	9374200	Car Charger
702504	9377700	Replacement Tray
702508	9394900	Replacement Tray, Set of 4
702509	9418100	Replacement Sample Cup
702511	9431700	Replacement Nose Cone

Pumps



TABLE OF CONTENTS

Utility Pumps	282
Submersible Dewatering/Utility Pumps	282-284
Submersible Sump Pumps	285-286
Pump Accessories	286
Effluent Pumps	287-289
Sewage Pumps	289-293
Grinder Pumps	293-295
Pump Control Panels	296-297
Trash Pumps	298-302
Diaphragm Pumps	303
Drum Pumps	304-305
Hydrostatic Test Pumps	305
Centrifugal Pumps	306

Pump Stick® Cordless Water Transfer Pump



The Reed Pump Stick Cordless Water Transfer Pump is versatile and portable. This jobsite-friendly tool is a must have for contractors and municipal water & wastewater maintenance departments. Purchase model with included battery or use your own battery with specific brand battery adapter plate (order separately). Both models come with a 2 ft discharge hose; order a 4 ft or 7 ft discharge hose separately.

FEATURES & BENEFITS

- Ideal solution to pump out sumps, valves boxes and meter pits
- Compatible with different 18V to 20V battery brands—order a battery adapter plate separately
- Water resistant, sealed on/off switch
- Long slim design allows for pump placement into small meter pits
- Secure magnetic hose connection

SPECIFICATIONS

FLOW RATE (GPM)	15
PUMP HEAD (ft)	12
RUN TIME (APPROXIMATE)	4Ah, 60 min
PUMP LENGTH	48.5"
WEIGHT (lbs)	6
MATERIAL	Durable, hard shell aluminum body shaft

Note: Battery adapter plates fit current slide style batteries. We also recommend ordering these accessories:
 Item# 103571 Stainless steel marine strainer
 Item# 103567 Discharge Hose (7 ft L) along with Item# 103568 Hose Coupling with magnetic connection to increase length of discharge hose

C&M PART #	MFG PART #	DESCRIPTION
103503	08140	Pump Stick with 2' Discharge Hose, 18V Bosch® Battery, Charger and Hard-Shell Case
103502	08141	Pump Stick with 2' Discharge Hose, with Battery Plate for Bosch 18V Battery (Battery NOT included)

REPLACEMENT PARTS & ACCESSORIES

C&M PART #	MFG PART #	DESCRIPTION
103569	98193	Optional Hard Carrying Standard Case
103566	98144	Optional 4 ft Discharge Hose
103567	98145	Optional 7 ft Discharge Hose
103568	98147	Hose Coupling with Magnetic Connection
103545	98140	Optional Adapter Plate for DeWalt® 20V Batteries
103562	98141	Optional Adapter Plate for Milwaukee® 18V Batteries
103563	98149	Optional Adapter Plate for Mikita® 18V Batteries
103571	98188	Marine Strainer, Stainless Steel
103572	98189	Strainer with Domed Center

Liberty Utility Pump

Lightweight and portable, the Liberty pump model 260-2 is perfect for miscellaneous water removal from flooded areas or other clear water transfer applications. Completely submersible and powered by a 1/6-hp motor, it pumps down to as low as 1/8". Garden hose connection.



FEATURES & BENEFITS

- Impact-, stress- and corrosion-resistant thermoplastic body offers long service life
- Self-cleaning trash-type impeller
- 1/6 hp air cooled PSC motor pumps up to 17 GPM
- Shaft seal and lip seal
- Removable bottom screen for easy cleaning

INCLUDES

3/4" NPT and 3/4" garden hose adapter. Order Hose separately

SPECIFICATIONS

MOTOR	Air Cooled, PSC Motor, Thermal Overload Protection
MAX FLOW RATE (GPM)	17
MAX DISCHARGE HEAD (ft)	25
POWER CORD (ft)	25-ft, with plug

CERTIFICATIONS

- CSA

C&M PART #	MFG PART #	DISCHARGE	HP	VOLTS	AMPS	WEIGHT (lbs)
105864	260-2	Garden Hose, Male	1/6	120 VAC	2	7.5

REPLACEMENT PARTS & ACCESSORIES

C&M PART #	DESCRIPTION
110562TGA94C	Green Rubber Vinyl Five-Ply Garden Hose, 5/8" x 25 ft

Dixon Valve Garden Hose

Premium reinforced EPDM Garden Hose offers excellent durability yet remains flexible. The kink-resistant hose is easy to use and wind up.



FEATURES & BENEFITS

- Professional-grade reinforcement provides maximum strength
- Ultimate kink resistance ensures full water flow
- EPDM hose is lead free, making it drinking water safe
- 40% lighter than standard rubber hose

C&M PART #	MFG PART #	DESCRIPTION
110566TGSV4D	PGH50	5/8" x50 ft Black Professional Grade Reinforced EPDM Water Hose

AMT® Submersible Dewatering Pump, 12 VDC

This AMT 12 VDC Submersible Pump is designed for use in dewatering applications where limited or no electricity is present and for emergency back-up during power failures. Use this submersible pump for pumping out meter pits, manholes and valve boxes.

FEATURES & BENEFITS

- Operates approximately 60 minutes on fully charged 55 amp-hour battery
- Built-in carrying handle
- Built-in steel strainer protects pump
- On/off switch and overload protection
- Durable aluminum construction with aluminum impeller
- Buna-N mechanical seal with carbon and ceramic faces

Note: Order discharge hose separately.

SPECIFICATIONS

SOLIDS HANDLING	0.38"
IMPELLER	Cast Aluminum
SEAL	Buna Carbon Ceramic
MOTOR	12 VDC
POWER CORD (ft)	30-ft, with battery clips
MAX FLOW RATE (GPM)	43
MAX DISCHARGE HEAD (ft)	26

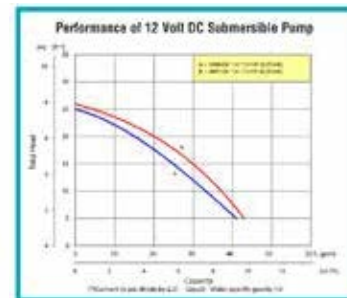

C&M PART #	MFG PART #	DISCHARGE SIZE	HP	VOLTS	AMPS	WEIGHT (lbs)
100713	5891-DC	1-1/2" NPT(F)	1/3	12 VDC	26	40

REPLACEMENT PARTS & ACCESSORIES

C&M PART #	DESCRIPTION
10234201BC40	1-1/2" x 50 ft Blue PVC Water Discharge Hose, M x F Threads
10234202BC40	1-1/2" x 50 ft Blue PVC Water Discharge Hose, M x F Aluminum Quick Couplings
102409	1-1/2" Aluminum Quick Coupling Male Adapter, Part 'F' x NPT(M) Threads

AMT Submersible Contractor Pumps

AMT Submersible Contractor Dewatering Pumps are lightweight, portable, reliable and energy efficient. These clog-resistant pumps are ideal for dewatering, construction drainage, flooding and other applications requiring clear/drainage water removal. Cast iron construction with stainless steel motor housing, heavy-duty strainer and carbon/ceramic mechanical seal offer excellent durability and long service life. Choose from Manual or Automatic w/Float Switch Models.

FEATURES & BENEFITS

- Continuous duty rated motor with automatic thermal protection
- Cast Iron construction with stainless steel motor housing provide durability
- Clog resistant impeller easily handles liquids with solids content
- Built-in carrying handle for portability
- Heavy-duty strainers (polypropylene for 1/2-hp model and stainless steel for 1-hp model) prevents large solids from damaging the pump
- Carbon/Ceramic mechanical seal plus shaft seal

Note: Order Discharge Hose Separately

SPECIFICATIONS

SOLIDS HANDLING	2" Pumps: 5/32"; 3" Pump: 7/32"
IMPELLER	Cast Iron, Semi Open
SEAL	1/2 HP Models: Single Mechanical, Carbon/Ceramic 1 HP Models: Double Mechanical, Carbon/Ceramic
MOTOR	115 VAC, 1-Phase, Automatic Thermal Protection
POWER CORD (ft)	20-ft, with grounded plug



5981-95

598A-95

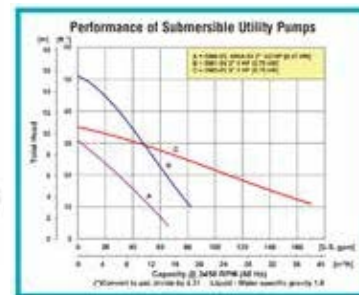

CERTIFICATIONS

- UL/CSA

C&M PART #	MFG PART #	TYPE	DISCHARGE SIZE	HP	VOLTS/ PHASE	AMPS	WEIGHT (lbs)
100710	5980-95	Manual	2" NPT(F)	1/2	115 VAC/1	7.5	26
100711	5981-95	Manual	2" NPT(F)	1	115 VAC/1	13	46
100712	5983-95	Manual	3" NPT(F)	1	115 VAC/1	13	53
100709	598A-95	Automatic	2" NPT(F)	1/2	115 VAC/1	7.5	24

REPLACEMENT PARTS & ACCESSORIES

C&M PART #	DESCRIPTION
10234201BC50	2" x 50 ft Blue PVC Discharge Hose, M x F Threads
10234202BC50	2" x 50 ft Blue PVC Discharge Hose, Quick Connect Fittings (M x F)
102410	2" Aluminum Quick Coupling, Part 'F' Male Adapter x NPT(M) Threads
10234201BC87	3" x 50 ft Blue PVC Discharge Hose, M x F Threads
10234202BC87	3" x 50 ft Blue PVC Discharge Hose, Quick Connect Fittings (M x F)
102411	3" Aluminum Quick Coupling, Part 'F' Male Adapter x NPT(M) Threads



Tsurumi Submersible Dewatering Pumps



Tsurumi LB Series Dewatering Pumps feature a top discharge for maximum motor cooling efficiency. Pumps are rated for continuous-duty operation at low water levels and extended dry-run capability. Impeller suspends solids and allows for pumping of sand and stringy material.

Pumps are available in manual or automatic models. Slim design of manual models allows the pumps to fit into 8" diameter pipes. The automatic model, LB-480A, incorporates a level sensor module that turns the pump off when water is not present, saving energy and extending the life of the motor and bearings. Level sensor module is completely molded in resin and covered by a rubber case for protection against rough handling. Automatic model also features a 60-second delay timer to eliminate frequent on/off cycling operation in rough water to extend motor life.

FEATURES & BENEFITS

- For use in commercial, industrial wastewater and site drainage
- Urethane, semi vortex Impeller and wear plates for maximum durability and maintaining pump performance
- Dual inside mechanical seal with SiC faces provides longer operational life
- Oil lifter provides lubrication of the seal faces provides for exceptional durability
- V-ring seal design protects mechanical seal from abrasive particles

SPECIFICATIONS

SOLIDS HANDLING	1/4"
IMPELLER	Urethane Rubber, High Chrome Cast Iron
SEAL	Dual Inside Mechanical with Silicon Carbide Faces
MOTOR	115 VAC
CORD LENGTH (ft)	LB480 series models: 32-ft, LB800: 50-ft
MAX FLOW RATE (GPM)	LB480 series models: 62, LB800: 82
MAX DISCHARGE HEAD (ft)	LB480 series models: 39'; LB480: 58'

CERTIFICATIONS

- ETL

C&M PART #	MFG PART #	TYPE	DISCHARGE SIZE	HP	VOLTAGE	AMPS	WEIGHT (lbs)
111176	LB480	Manual	2" NPT(M)	2/3	115 VAC	6.1	28
111177	LB480A	Automatic	2" NPT(M)	2/3	115 VAC	6.1	29
111178	LB800	Manual	2" NPT(M)	1	115 VAC	9.6	37

REPLACEMENT PARTS & ACCESSORIES

C&M PART #	DESCRIPTION
10234201BC50	2" x 50 ft Blue PVC Discharge Hose, M x F Threads

Tsurumi Submersible Dewatering Pumps, Low Level, High Volume

Use the Tsurumi LSR2.4S Submersible Low-Level Dewatering Pump for complete drainage of flat surfaces. Pump holds suction for drainage to 0.4" water level to pump even the smallest puddle—ideal for when a sump is not available.



FEATURES & BENEFITS

- For use in commercial, industrial wastewater and site drainage
- Urethane semi vortex impeller for maximum durability and pump performance
- Dual inside mechanical seal with SiC faces for longer life
- Oil lifter provides lubrication of the seal faces
- V-ring seal design protects mechanical seal from abrasive particles



SPECIFICATIONS

SOLIDS HANDLING	1/4"
IMPELLER	Semi-Vortex, Urethane Rubber
SEAL	Double Inside Mechanical, Silicon Carbide Faces
MOTOR	115 VAC, Thermal Overload Protected
POWER CORD (ft)	32-ft, with plug
MAX FLOW RATE (GPM)	62
MAX DISCHARGE HEAD (ft)	39

CERTIFICATIONS

- ETL

C&M PART #	MFG PART #	DISCHARGE SIZE	HP	VOLTAGE	AMPS	WEIGHT (LBS)
111183	LSR2.4S	2" NPT(M)	2/3	115 VAC	6.1	28

REPLACEMENT PARTS & ACCESSORIES

C&M PART #	DESCRIPTION
10234201BC50	2" x 50 ft Blue PVC Discharge Hose, M x F Threads

Abbott Rubber Blue PVC Water Discharge Hose

Blue PVC Water Discharge Hose is flexible and used to transfer fluids or materials from one location to another. It is designed to handle the flow of water under pressure and is commonly used in various industries and applications.



FEATURES & BENEFITS

- Rolls up flat for easy storage.
- Mildew resistant
- Close woven polyester jacket impregnated with PVC.
- Temperature range -5° to 140° F

C&M PART #	MFG PART #	DIAMETER (in)	LENGTH (ft)	HOSE ENDS
10234201BC40	1148-1500-50-NPSH	1.5	50	M x F NPSH
10234201BC50	1148-2000-50-NPSH	2	50	M x F NPSH
10234201BC87	1148-3000-50-NPSH	3	50	M x F NPSH



Liberty 250/280/290-Series Submersible Sump Pumps

The 250/280/290-Series by Liberty covers a wide range of low-head to mid-range pump applications. Designed for STEP systems, mound systems, liquid waste transfer and high output sump applications, you can count these pumps to meet your pumping needs. Unique one-piece cast iron body construction and quick-disconnect cords offer durability, convenience and excellent performance. Models that incorporate Integral (quick-connect) and piggyback (plug) float switches; both are wide-angle and mercury-free.

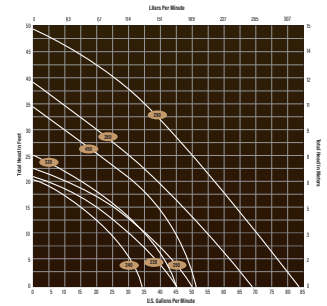

Liberty Pumps

SPECIFICATIONS

SERIES	250	280	290
IMPELLER	Vortex Engineered Polymer		
SOLIDS HANDLING	1/2"	3/4"	
THERMAL OVERLOAD	221°F (105°C)		248°F (120°C)
SHAFT AND HARDWARE	Stainless Steel		
MECHANICAL SEALS	Unitized Ceramic Carbon		
O-RINGS	Buna-N		
DISCHARGE	1-1/2" NPT		
VOLTAGE / PHASE	115 / 1		
FULL LOAD (Amps)	5.2	8.0	10.4
LOCKED ROTOR (Amps)	8	23	24
HORSEPOWER	1/3	1/2	3/4
MAX DISCHARGE HEAD (ft)	23	37	48
MAX FLOW RATE (GPM)	44	62	78
WEIGHT (lbs)	23	30	31

CERTIFICATIONS

- CSA

C&M PART #	MFG PART #	AUTOMATIC FLOAT TYPE	PUMP CORD LENGTH (ft)
250 SERIES			
105865N816	251	Integral Float	10
105865N814	253	Piggyback Float	10
105865X214	253-2	Piggyback Float	25
105865N817	257	Integral Vertical Float	10
280 SERIES			
105869N812	280	None	10
105869N813	281	Integral Float	10
105869N814	283	Piggyback Float	10
105869X214	283-2	Piggyback Float	25
105869N815	287	Integral Vertical Float	10
290 SERIES			
105874N813	291	Integral Float	10
105874N814	293	Piggyback Float	10
105874X214	293-2	Piggyback Float	25
105874N817	297	Integral Vertical Float	10

Zoeller M53 Mighty-Mate Submersible Sump Pumps

The Zoeller M53 Mighty-Mate Sump Pumps are known for its reliability, durability and performance. The heat-dissipating cast iron body with corrosion-resistant powder-coated epoxy finish provides maximum pumping performance under the most extreme conditions. The unique cool run design, the hermetically sealed, oil-filled motor and nonclogging vortex impeller add up to a long-lasting, trouble-free pump. The automatic model comes with a convenient float switch that will automatically turn on the pump when water reaches a certain level. 3 year warranty.

CERTIFICATIONS

- CSA

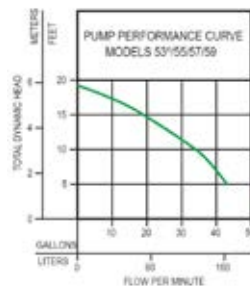

SPECIFICATIONS

IMPELLER	Plastic
IMPELLER TYPE	Nonclogging Vortex
SOLIDS HANDLING	1/2"
RPM	1550
HARDWARE	Stainless Steel
MOTOR SHAFT	AISI 1215 Cold-Rolled Steel
MECHANICAL SEALS	Ceramic and Carbon
GASKET	Neoprene
OPERATING TEMPERATURE	130°F (54°C)
DISCHARGE SIZE	1-1/2" NPT(F)
MAX DISCHARGE HEAD	19.25 ft
MAX FLOW RATE (GPM)	43 GPM
PUMP CORD LENGTH (ft)	9 (Auto); 15 (Manual)

C&M PART #	MFG PART #	MODEL	TYPE	HP	VOLTAGE (VAC)	FULL LOAD AMPS	WEIGHT (lbs)
10606611	53-0001	M53	Automatic	3/10	115	9.7	23
10606612	53-0002	N53	Manual	3/10	115	9.7	23



Zoeller M98 Flow-Mate Submersible Sump Pumps

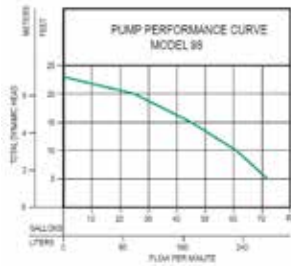

The Zoeller M98 Flow-Mate Sump Pumps are known for its reliability, durability and performance. These high-capacity pumps with maximum flow rate of 72 GPM can help prevent flooding after heavy rainfall or storm. The heat-dissipating cast iron body with corrosion-resistant powder-coated epoxy finish provides maximum pumping performance under the most extreme conditions. The unique cool run design, the hermetically sealed, oil-filled motor and nonclogging vortex impeller add up to a long-lasting, trouble-free pump. The automatic model comes with a convenient float switch that will automatically turn on the pump when water reaches a certain level. 3 year warranty.

SPECIFICATIONS

IMPELLER	Engineered Plastic
IMPELLER TYPE	Nonclogging Vortex
SOLIDS HANDLING	1/2"
RPM	1725
HARDWARE	Stainless Steel
MOTOR SHAFT	AISI 1215 Cold-Rolled Steel
MECHANICAL SEALS	Ceramic and Carbon
GASKET	Neoprene
OPERATING TEMPERATURE	130°F (54°C)
DISCHARGE SIZE	1-1/2" NPT(F)
MAX DISCHARGE HEAD (ft)	23
MAX FLOW RATE (GPM)	72
PUMP CORD LENGTH (ft)	9

CERTIFICATIONS

- CSA

C&M PART #	MFG PART #	MODEL	TYPE	HP	VOLTAGE (VAC)	FULL LOAD AMPS	WEIGHT (lbs)
10606811	98-0001	M98	Automatic	1/2	115	9.4	36
10606812	98-0002	N98	Manual	1/2	115	9.4	36

Check Valves



106165



106167

Install Zoeller "Full-Flow" Check Valves horizontally or vertically. The cast iron check valves withstand higher pressures, making them ideal for effluent and sewage pumps. The plastic check valves, made with flexible neoprene connections, work well for applications with extremely low pressures and stops backflow of water and sewer gas.

SPECIFICATIONS

MODEL	CAST IRON CHECK VALVES	PLASTIC CHECK VALVES
INSTALLATION	Horizontal or Vertical	
MAX OPERATING TEMPERATURE	130°F (54°C)	
MAX PSI	50	4.3
MAX STATIC HEAD (ft)	115	10

C&M PART #	MFG PART #	SIZE	CONNECTION	WEIGHT (lbs)
CAST IRON CHECK VALVES				
106165	30-0163	1-1/4"	NPT(F)	7.5
106166	30-0164	1-1/2"	NPT(F)	7.5
106163	30-0152	2"	NPT(F)	10
106164	30-0160	3"	NPT(F)	18
PLASTIC CHECK VALVES				
106162	30-0021	2"	Plastic Slip x Slip Unions	0.9
106167	30-0181	1-1/4" x 1-1/2"	Slip x Slip Union	1.6

Pump Float Switch

Zoeller's Switch-Mate pump float switch converts nonautomatic pump to automatic pump. Normally Open switch ("Pumps Down"). Mechanically activated, contains no mercury.



INCLUDES

Mounting Clamp

SPECIFICATIONS

MATERIAL	PVC/Polypropylene
VOLTAGE RATING (VAC)	115
AMP RATING (Max)	15
CORD LENGTH (ft)	15, w/piggyback plug

CERTIFICATIONS

- CSA, UL Recognized

C&M PART #	MFG PART #	DESCRIPTION
106160	10-0032	Zoeller Pump Float Switch

Zoeller M137 Flow-Mate Effluent Pumps



The Zoeller 137 Flow-Mate Pumps feature heavy-duty construction with oversized bearings and a balanced bronze, non-clogging vortex impeller. These features allow the pumps to provide up to 26 feet of head and flow up to 93 GPM. A unique cool run design lowers the operating temperatures ensuring longer duty cycle. Use these 1/2 hp effluent pumps for STEP systems, onsite or septic sump/dewatering applications. The automatic model comes with a float switch to automatically turn on/off the pump depending on the fluid level.

FEATURES & BENEFITS

- Upper ball bearing and lower sleeve bearing running in bath of oil
- Durable, cast construction: switch case motor and pump housing, base and impeller
- Oil-filled, hermetically sealed, automatic reset thermal overload protected (1 phase) motor for long service life
- No screens to clog

SPECIFICATIONS

SOLIDS HANDLING	Up to 5/8"
IMPELLER	Cast Iron
MAX OPERATING TEMPERATURE	130°F (54°C)
SHAFT	AISI 1215 Cold-Rolled Steel
MECHANICAL SEALS	Carbon & Ceramic
MAX DISCHARGE HEAD (ft)	26
FMAX LOW RATE (GPM)	93
PUMP CORD LENGTH (ft)	20

CERTIFICATIONS

- CSA approved unit with 15 Amp plug

C&M PART #	MFG PART #	HP	VOLTS / PHASE	DISCHARGE	FULL LOAD (Amps)	WEIGHT (lbs)
AUTOMATIC EFFLUENT PUMP						
10607011	137-0001	1/2	115 VAC / 1	1-1/2" NPT(F)	9.4	47
MANUAL EFFLUENT PUMP						
10607012	137-0002	1/2	115 VAC / 1	1-1/2" NPT(F)	9.4	47

Zoeller 160-Series Flow-Mate, High-Head Effluent Pumps



The Zoeller 160-Series Flow-Mate Pumps feature heavy-duty construction with oversized bearings and a balanced bronze, non-clogging vortex impeller. These features allow the pumps to provide over 86 feet of head and flow up to 100 GPM, making them ideal for commercial use. A unique cool run design incorporates fins to these pumps, lowering operating temperatures. Use these 1/2 hp effluent pumps for STEP systems, onsite or septic sump/dewatering applications. The automatic models come with a float switch to automatically turn on/off the pump depending on the fluid level.

FEATURES & BENEFITS

- Upper ball bearing and lower ball bearing running in bath of oil
- Cast iron cover, motor adapter and pump housing provide durability
- Oil-filled, hermetically sealed, automatic reset thermal overload protected for long service life

SPECIFICATIONS

SOLIDS HANDLING	Up to 3/4"
IMPELLER	Cast Iron
MAX OPERATING TEMPERATURE	130°F (54°C)
SHAFT	SAE 1117 Carbon Steel or 416 Stainless Steel
MECHANICAL SEALS	Carbon & Ceramic
MAX DISCHARGE HEAD (ft)	86.5
MAX FLOW RATE (GPM)	100
PUMP CORD LENGTH (ft)	20

CERTIFICATIONS

- CSA approved unit with 15 Amp plug

C&M PART #	MFG PART #	HP	VOLTS / PHASE	DISCHARGE	FULL LOAD (Amps)	WEIGHT (lbs)
AUTOMATIC EFFLUENT PUMPS						
106072110EOZ	161-0001	1/2	115 VAC / 1	1-1/2" NPT(F)	15	80
106072110EPA	161-0003	1/2	230 VAC / 3	1-1/2" NPT(F)	7.5	80
106072110EOZ	163-0001	1/2	115 VAC / 1	1-1/2" NPT(F)	15	80
106072110EPA	163-0003	1/2	230 VAC / 3	1-1/2" NPT(F)	7.5	80
1060761130PA	165-0003	1	230 VAC / 3	1-1/2" NPT(F)	7.5	80
MANUAL EFFLUENT PUMPS						
106072120EOZ	161-0002	1/2	115 VAC / 1	1-1/2" NPT(F)	15	80
106072120EPA	161-0004	1/2	230 VAC / 3	1-1/2" NPT(F)	7.5	80
106072120EOZ	163-0002	1/2	115 VAC / 1	1-1/2" NPT(F)	15	80
106072120EPA	163-0004	1/2	230 VAC / 3	1-1/2" NPT(F)	7.5	80
1060761230PA	165-0004	1	230 VAC / 3	1-1/2" NPT(F)	7.5	80

Liberty FL100-Series High-Head Effluent Pumps

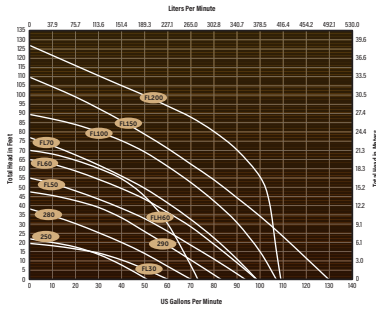

The Liberty FL100-Series Pumps cover a wide-range of high-head pump applications. These 1 hp effluent pumps are specially designed for STEP systems, mound systems, liquid waste transfer and higher head dewatering applications. The pump features a dual-sized threaded discharge of 1-1/2" and 2" for connection to either size pipe. Constructed of heavy cast iron with an epoxy powder coat finish and stainless steel (SS) hardware, these pumps will provide years of reliable performance. The automatic model comes with a float switch to automatically turn on/off the pump depending on the fluid level. 3-Year Warranty.

FEATURES & BENEFITS

- Heavy cast iron and SS construction for long service life
- Semi-open cast iron impeller handles solids up to 3/4" in diameter
- Dual shaft seals
- Convenient dual-sized threaded discharge to suit your pumping needs

SPECIFICATIONS

SOLIDS HANDLING	Up to 3/4"
IMPELLER	Three Vane Class 25 Cast Iron
MAX LIQUID TEMPERATURE	104°F (40°C) Continuous Duty
THERMAL OVERLOAD	248°F (120°C) Single Phase Only
SHAFT	Stainless Steel
O-RINGS	Buna-N
MECHANICAL SEALS	Unitized Carbon Ceramic
MAX DISCHARGE HEAD (ft)	90
MAX FLOW RATE (GPM)	106
PUMP CORD LENGTH	25 ft, Quick Connect Cord

CERTIFICATIONS

- CSA

C&M PART #	MFG PART #	HP	VOLTS / PHASE	DISCHARGE*	FULL LOAD (Amps)	WEIGHT (lbs)
AUTOMATIC EFFLUENT PUMP						
1058821130PD	FL102A-2	1	208-230 VAC / 1	1-1/2 & 2" NPT(F)	12	81
MANUAL EFFLUENT PUMPS						
1058821230PD	FL102M-2	1	208-230 VAC / 1	1-1/2 & 2" NPT(F)	12	78
1058821287PD	FL103M-2	1	208-230 VAC / 3	1-1/2 & 2" NPT(F)	9	71
1058821287PG	FL104M-2	1	440-480 VAC / 3	1-1/2 & 2" NPT(F)	4.5	71

*2" NPT(F) threaded discharge with 1-1/2" NPT(F) flange provided.

Liberty FL150-Series High-Head Effluent Pumps

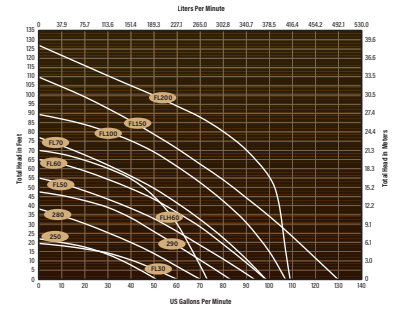

The Liberty FL150-Series Pumps cover a wide-range of high-head pump applications. These 1-1/2 hp effluent pumps are specially designed for STEP systems, mound systems, liquid waste transfer and higher head dewatering applications. Constructed of heavy cast iron with an epoxy powder coat finish and stainless steel (SS) hardware, these pumps will provide years of reliable performance. The automatic model comes with a float switch to automatically turn on/off the pump depending on the fluid level. 3-Year Warranty.

FEATURES & BENEFITS

- Heavy cast iron and SS construction for long service life
- Semi-open cast iron impeller handles solids up to 3/4" in diameter
- Dual shaft seals
- Convenient dual-sized threaded discharge to suit your pumping needs

SPECIFICATIONS

SOLIDS HANDLING	Up to 3/4"
IMPELLER	Two Vane Class 25 Cast Iron
MAX LIQUID TEMPERATURE	104°F (40°C) Continuous Duty
THERMAL OVERLOAD	275°F (135°C) Single Phase Only
SHAFT	Stainless Steel
O-RINGS	Buna-N
MECHANICAL SEALS	Unitized Carbon Ceramic
MAX DISCHARGE HEAD (ft)	110
MAX FLOW RATE (GPM)	130
PUMP CORD LENGTH	25 ft, Quick Connect Cord

CERTIFICATIONS

- CSA

C&M PART #	MFG PART #	HP	VOLTS / PHASE	DISCHARGE*	FULL LOAD (Amps)	WEIGHT (lbs)
AUTOMATIC EFFLUENT PUMP						
1058861330PD	FL152A-2	1-1/2	208-230 VAC / 1	1-1/2 & 2" NPT(F)	15	82
MANUAL EFFLUENT PUMPS						
1058861230PD	FL152M-2	1-1/2	208-230 VAC / 1	1-1/2 & 2" NPT(F)	15	81
1058861287PD	FL153M-2	1-1/2	208-230 VAC / 3	1-1/2 & 2" NPT(F)	11.4	81
1058861287PG	FL154M-2	1-1/2	440-480 VAC / 3	1-1/2 & 2" NPT(F)	5.7	81

*2" NPT(F) threaded discharge with 1-1/2" NPT(F) flange provided.

Liberty FL200-Series High-Head Effluent Pumps

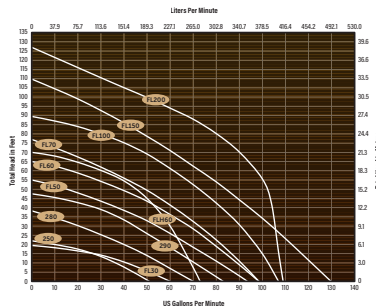

The Liberty FL200-Series Pumps cover a wide-range of high-head pump applications. These 2 hp effluent pumps are specially designed for STEP systems, mound systems, liquid waste transfer and higher head dewatering applications. The pump features a dual-sized threaded discharge of 1-1/2" and 2" for connection to either size pipe. Constructed of heavy cast iron with an epoxy powder coat finish and stainless steel (SS) hardware, these pumps will provide years of reliable performance. The automatic model comes with a float switch to automatically turn on/off the pump depending on the fluid level. 3-Year Warranty.

FEATURES & BENEFITS

- Heavy cast iron and SS construction for long service life
- Semi-open cast iron impeller handles solids up to 3/4" in diameter
- Dual shaft seals
- Convenient dual-sized threaded discharge to suit your pumping needs

SPECIFICATIONS

SOLIDS HANDLING	Up to 3/4"
IMPELLER	Two Vane Class 25 Cast Iron
MAX LIQUID TEMPERATURE	104°F (40°C) Continuous Duty
THERMAL OVERLOAD	275°F (135°C) Single Phase Only
SHAFT	Stainless Steel
O-RINGS	Buna-N
MECHANICAL SEALS	Unitized Carbon Ceramic
MAX DISCHARGE HEAD (ft)	130
MAX FLOW RATE (GPM)	102
PUMP CORD LENGTH	25 ft, Quick Connect Cord

CERTIFICATIONS

- CSA

C&M PART #	MFG PART #	HP	VOLTS / PHASE	DISCHARGE*	FULL LOAD (Amps)	WEIGHT (lbs)
AUTOMATIC EFFLUENT PUMP						
1058781130PD	FL202A-2	2	208-230 VAC / 1	1-1/2 & 2" NPT(F)	15	83
MANUAL EFFLUENT PUMPS						
1058781230PD	FL202M-2	2	208-230 VAC / 1	1-1/2 & 2" NPT(F)	15	82
1058781287PD	FL203M-2	2	208-230 VAC / 3	1-1/2 & 2" NPT(F)	11.4	82
1058781287PG	FL204M-2	2	440-480 VAC / 3	1-1/2 & 2" NPT(F)	5.7	82

*2" NPT(F) threaded discharge with 1-1/2" NPT(F) flange provided.

Zoeller 260-Series Waste-Mate Sewage Pumps

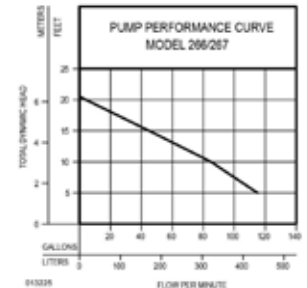

The Zoeller 260-Series Waste-Mate Sewage Pumps are specifically designed to handle the pumping and removal of sewage and wastewater. These pumps are typically submersible and commonly used in residential, commercial, and industrial applications where sewage needs to be transported from one location to another, such as from a basement or lower-level bathroom to the main sewer line. Durable material construction withstands the corrosive and abrasive nature of sewage and wastewater.

FEATURES & BENEFITS

- Hermetically sealed, automatic reset thermal overload protection offer long service life
- Upper and lower sleeve bearings running in oil bath

SPECIFICATIONS

SOLIDS HANDLING	2"
IMPELLER	Engineered Plastic with Metal Insert
MAX OPERATING TEMPERATURE	130°F (54°C)
SHAFT	AISI 1215 Cold-Rolled Steel
MECHANICAL SEALS	Carbon & Ceramic
MAX DISCHARGE HEAD (ft)	21.5
MAX FLOW RATE (GPM)	128
PUMP CORD LENGTH (ft)	10 (Automatic); 15 (Manual)

CERTIFICATIONS

- CSA approved unit with 15 Amp plug.

C&M PART #	MFG PART #	HP	VOLTS / PHASE	FULL LOAD (Amps)	DISCHARGE SIZE	WEIGHT (lbs)
AUTOMATIC SEWAGE PUMPS						
10608211	266-0001	1/2	115 VAC / 1	9.4	2" NPT(F)	41
106084110Z	267-0001	1/2	115 VAC / 1	9.4	2" NPT(F)	47.5
10608411PA	267-0003	1/2	230 VAC / 1	4.7	2" NPT(F)	47.5
MANUAL SEWAGE PUMPS						
10608212	266-0002	1/2	115 VAC / 1	9.4	2" NPT(F)	41
106084120Z	267-0002	1/2	115 VAC / 1	9.4	2" NPT(F)	47.5
10608412PA	267-0004	1/2	230 VAC / 1	4.7	2" NPT(F)	47.5



Zoeller 290 Series Waste-Mate Sewage Pumps



The Zoeller 290-Series Waste-Mate Sewage Pumps are specifically designed to handle the pumping and removal of sewage and wastewater. Heavy-duty construction, oversized bearings and balanced non-clogging vortex impellers allow these pumps to stand up to the highest heads and maximum flows. A unique cool run design incorporates fins to these pumps, lowering operating temperatures. The corrosion-resistant, powder-coated epoxy finish and hermetically sealed, oil-filled motor add up to a long-lasting, trouble-free product.

SPECIFICATIONS

MODEL	292	293	294	295
SOLIDS HANDLING	2"			
IMPELLER	Cast Iron*, Non-Clogging Vortex			
MAX OPERATING TEMPERATURE	130°F (54°C)			
SHAFT	1117 Carbon Steel			
MECHANICAL SEALS	Carbon & Ceramic			
MAX DISCHARGE HEAD (ft)	40	51	62	75
MAX FLOW RATE (GPM)	135	122	196	214
PUMP CORD LENGTH (ft)	20			

*Optional bronze impeller available.

CERTIFICATIONS

- CSA

C&M PART #	MFG PART #	MODEL	HP	VOLTS / PHASE	FULL LOAD (Amps)	DISCHARGE SIZE	WEIGHT (lbs)
AUTOMATIC SEWAGE PUMP							
1060881130OZ	292-0001	M292	1/2	115 VAC / 1	15	2" NPT(F)	86
MANUAL SEWAGE PUMPS							
1060881230PA	293-0004	E293	1	230 VAC / 1	10.2	2" or 3" NPT(F)	86
1060881287PA	293-0011	F293	1	230 VAC / 3	7.6	2" or 3" NPT(F)	89
1060881287FC	293-0014	G293	1	460 VAC / 3	4.0	2" or 3" NPT(F)	89
1060920G30PA	294-0004	E294	1-1/2	230 VAC / 1	13.7	2" or 3" NPT(F)	86
1060920G87PA	294-0006	F294	1-1/2	230 VAC / 3	9.5	2" or 3" NPT(F)	89
1060920G87FC	294-0005	G294	1-1/2	460 VAC / 3	4.8	2" or 3" NPT(F)	89
1060925087PA	295-0008	F295	2	230 VAC / 3	9.5	2" or 3" NPT(F)	89
1060925087FC	295-0009	G295	2	460 VAC / 3	6.1	2" or 3" NPT(F)	91

Zoeller 600 Series Sewage Pumps



The Zoeller 600-Series Sewage Pumps are built to provide reliable performance over a long service life. Engineered for large commercial and industrial applications, these pumps utilize extended vane ductile iron impellers for improved efficiency and performance. The tandem seal design provides additional protection from abrasives typically found in demanding applications. Cooling fins, not commonly found in this type of pump, lower operating temperatures, providing longer motor and bearing life. Rail systems are available for ease of installation and removal.

SPECIFICATIONS

SERIES	641	651	661
SOLIDS HANDLING	2-1/2"		
IMPELLER	Semi-Open Ductile Iron		
MAX OPERATING TEMPERATURE	104°F (40°C)		
SHAFT AND HARDWARE	Stainless Steel		
MECHANICAL SEALS	Tandem Carbon & Ceramic		
O-RINGS	Buna-N		
DISCHARGE	3" NPT(F) (Optional 3" or 4" Flange Available)		
HORSEPOWER	3	5	7-1/2
MAX DISCHARGE HEAD (ft)	44	46.5 (ph.1), 54	48
MAX FLOW RATE (GPM)	460	475 (ph.1), 533	78

CERTIFICATIONS

- CSA

C&M PART #	MFG PART #	MODEL	VOLTAGE / PHASE	FULL LOAD (Amps)	WEIGHT (lbs)
641 SERIES					
1060978730PA	641-0004	641E*	230 VAC / 1	17.0	245
1060978787PA	641-0008	641F	230 VAC / 3	9.6	245
1060978787FC	641-0010	641G	460 VAC / 3	4.8	245
651 SERIES					
106097F930PA	651-0004	651E*	230 VAC / 1	28	245
106097F987PA	651-0008	651F	230 VAC / 3	15.2	245
106097F987FC	651-0010	651G	460 VAC / 3	7.6	245
661 SERIES					
1060970M87PA	661-0008	661F	230 VAC / 3	22.0	245
1060970M87FC	661-0010	661G	460 VAC / 3	11.0	245

*All single-phase units require external starting capacitor and relay circuits.

Liberty LE40-Series Submersible Sewage Pumps

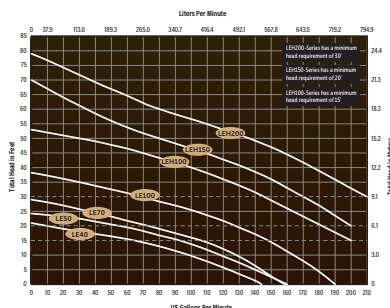

Heavy-duty built and reliable, Liberty LE40-Series Submersible Pumps are the perfect choice for residential sewage applications. Featuring all cast iron construction with an epoxy powder-coat finish, stainless steel fasteners, quick-disconnect power cord and a vortex style impeller for superior solids handling, these pumps combine solid performance with exceptional value. Models with the automatic feature come equipped a float switch to automatically turn on/off the pump depending on the fluid level, select from wide angle float switch models or for where space is at a premium, select vertical switch model.

FEATURES & BENEFITS

- Oil-filled, thermally protected motor extend pump life
- Permanently lubricated ball bearings

SPECIFICATIONS

HORSEPOWER	4/10
SOLIDS HANDLING:	Up to 2"
IMPELLER:	Vortex Engineered Polymer
THERMAL OVERLOAD TEMPERATURE	221°F (105°C)
SHAFT	Stainless Steel
MECHANICAL SEALS	Unitized Carbon Ceramic
MAX DISCHARGE HEAD (ft)	20
MAX FLOW RATE (GPM)	125
PUMP CORD LENGTH (ft)	10

CERTIFICATIONS

- CSA

C&M PART #	MFG PART #	AUTOMATIC	DISCHARGE SIZE	VOLTAGE (VAC)	FULL LOAD (Amps)	WEIGHT (lbs)
10589012	LE41M	No	2" NPT(F)	115	12	40
10589011	LE41A	Wide Angle	2" NPT(F)	115	12	40
10589017	LE41AV	Vertical Switch	2" NPT(F)	115	12	40

Liberty LE50-Series Submersible Sewage Pumps

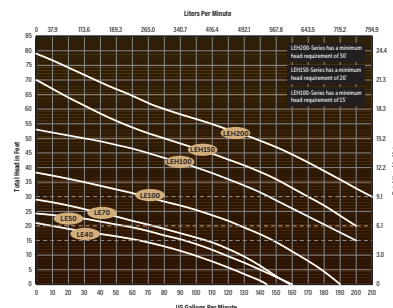

Commercial Grade Liberty LE50-Series Submersible Sewage Pumps are ideal for residential and light commercial applications. Its efficient motor with permanently lubricated bearings, heavy cast iron body, stainless steel fasteners and quick-connect power cord design make these pumps a favorite choice among professionals. Models with the automatic feature come equipped a float switch to automatically turn on/off the pump depending on the fluid level, select from wide angle float switch models or for where space is at a premium, select vertical switch model.

SPECIFICATIONS

HORSEPOWER	1/2
PHASE	1
SOLIDS HANDLING	Up to 2"
IMPELLER	Two Vane Engineered Thermoplastic Elastomer
THERMAL OVERLOAD TEMPERATURE	221°F (105°C)
SHAFT	Stainless Steel
MECHANICAL SEALS	Unitized Carbon Ceramic
MAX DISCHARGE HEAD (ft)	24
MAX FLOW RATE (GPM)	141
PUMP CORD LENGTH (ft)	10

CERTIFICATIONS

- CSA

C&M PART #	MFG PART #	VOLTAGE	FULL LOAD (Amps)	DISCHARGE SIZE	AUTOMATIC	WEIGHT (lbs)
10589312OZ	LE51M	115 VAC	12	2" NPT(F)	No	43
10589311OZ	LE51A	115 VAC	12	2" NPT(F)	Wide Angle	43
1058931117	LE51AV	115 VAC	12	2" NPT(F)	Vertical Switch	43
10589312PD	LE52M	208-230 VAC	6.8	2" NPT(F)	No	43
10589311PD	LE52A	208-230 VAC	6.8	2" NPT(F)	Wide Angle	43



Liberty LE70-Series Submersible Sewage Pumps

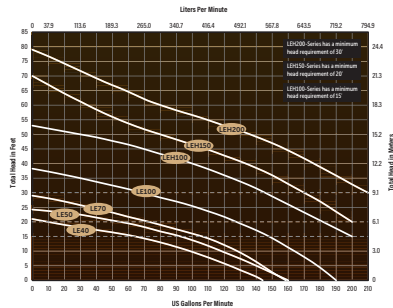

Liberty LE70-Series Submersible Sewage Pumps with its efficient motor, permanently lubricated bearings, stainless steel fasteners and quick-connect power cord design are a favorite choice among professionals. This heavy-duty cast iron construction pumps handle solids up to 2" and have shut-off head of 29 feet. Models with the automatic feature come equipped a float switch to automatically turn on/off the pump depending on the fluid level.

SPECIFICATIONS

HORSEPOWER	3/4
SOLIDS HANDLING	2"
IMPELLER	2 Vane Engineered Thermoplastic Elastomer
THERMAL OVERLOAD TEMPERATURE	221°F (105°C) Single Phase Only
SHAFT	Stainless Steel
MECHANICAL SEALS	Unitized Carbon Ceramic
MAX DISCHARGE HEAD (ft)	28 ft
MAX FLOW RATE (GPM)	144 GPM
PUMP CORD LENGTH (ft)	10 (LE7XX2), 25 (LE7XXX2-2)

CERTIFICATIONS

- CSA

C&M PART #	MFG PART #	VOLTAGE/ PHASE	FULL LOAD (Amps)	DISCHARGE SIZE	AUTOMATIC	WEIGHT (lbs)
10589812OZ	LE71M2	115 VAC / 1	12	2" NPT(F)	No	62
10589811OZ	LE71A2	115 VAC / 1	12	2" NPT(F)	Yes	62
10589812PD	LE72M2	208-230 VAC / 1	6	2" NPT(F)	Yes	62
10589811PD	LE72A2	208-230 VAC / 1	6	2" NPT(F)	Yes	62
105902PD	LE73M2-2	208-230 VAC / 3	4.1	2" NPT(F)	No	62
105902PG	LE74M2-2	440-480 VAC / 3	2.1	2" NPT(F)	No	62

Liberty LE100-Series Submersible Sewage Pumps

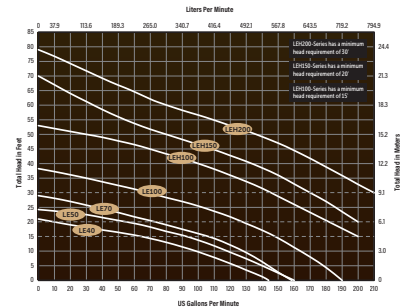

The Liberty LE100-Series Sewage Pumps have 2" solids-handling capability. Constructed of heavy cast iron with a tough epoxy powder-coat finish and stainless steel fasteners, these pumps provide years of trouble-free performance. The quick-connect power cord allows for fast and easy interchange. The automatic model comes with a float switch to automatically turn on/off the pump depending on the fluid level. 3-Year standard limited warranty.

FEATURES & BENEFITS

- Semi-open cast iron impeller provides clog-free pumping
- Cast iron housing and volute and stainless and brass fasteners ensure durability
- Oil-filled, hermetically sealed motors

SPECIFICATIONS

SOLIDS HANDLING	Up to 2"
IMPELLER	Two Vane Class 25 Cast Iron
THERMAL OVERLOAD TEMPERATURE	221°F (105°C) Single Phase Only
SHAFT	Stainless Steel
MECHANICAL SEALS	Unitized Carbon Ceramic Single Phase
MAX DISCHARGE HEAD (ft)	39 ft
MAX FLOW RATE (GPM)	160 GPM
PUMP CORD LENGTH (ft)	10 (LEXXA2/M2); 25 (LE102M2-2/LE104M2-2)

CERTIFICATIONS

- CSA

C&M PART #	MFG PART #	HP	VOLTS/ PHASE	FULL LOAD (Amps)	DISCHARGE SIZE	WEIGHT (lbs)
AUTOMATIC SEWAGE PUMP						
105904NB11PD	LE102A2	1	208-230 VAC / 1	8	2" NPT(F)	64
MANUAL SEWAGE PUMPS						
105904NB12PD	LE102M2	1	208-230 VAC / 1	8	2" NPT(F)	64
105904X212PD	LE102M2-2	1	208-230 VAC / 1	8	2" NPT(F)	64
105904X212PG	LE104M2-2	1	440-480 VAC / 3	2.5	2" NPT(F)	64

Liberty LEH-Series Submersible Sewage Pumps

The Liberty LEH Series Sewage Pumps are a robust and dependable solution for all your sewage and wastewater management needs. Specially designed to handle the toughest challenges, these powerful pumps provide efficient and reliable operation day after day. Whether you need to remove sewage from residential or commercial areas, these pumps will get the job done effectively. Models with the automatic feature come equipped a float switch to automatically turn on/off the pump depending on the fluid level. 3-Year Warranty.

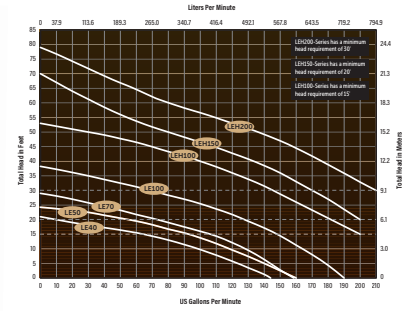

Liberty Pumps

SPECIFICATIONS

SERIES	LEH100 SERIES	LEH150 SERIES	LEH200 SERIES
SOLIDS HANDLING	2"		
IMPELLER	Two Vane Class 25 Cast Iron		
HORSEPOWER	1	1.5	2
MAX LIQUID TEMP	140°F (60°C)	104°F (40°C)	
THERMAL OVERLOAD	248°F (120°C)		275°F (135°C)
SHAFT	Stainless Steel		
HARDWARE	Stainless Steel		
O-RINGS	Buna-N		
MECHANICAL SEALS	Unitized Carbon Ceramic (Single Phase); Unitized Silicon Carbide (Three Phase)		
MAX DISCHARGE HEAD (ft)	53	70	79
MAX FLOW RATE (GPM)	197	200	210
WEIGHT (lbs)	64	92	95
PUMP CORD LENGTH (ft)	10 / 25*	25	

*LEH102A2 and LEH102M2 come with a 10 ft cord; all other models come with a 25 ft cord.

C&M PART #	MFG PART #	VOLTS / PHASE	FULL LOAD (Amps)	DISCHARGE SIZE	AUTOMATIC
LEH100 SERIES					
105908NB11PD	LEH102A2	230 VAC / 1	12	2" NPT(F)	Yes
105908NB12PD	LEH102M2	230 VAC / 1	12	2" NPT(F)	No
105908X212PD	LEH103M2-2	208-230 VAC / 3	9	2" NPT(F)	No
105908X212PG	LEH104M2-2	440-480 VAC / 3	4.5	2" NPT(F)	No
LEH150 SERIES					
1059121130PD	LEH152A2-2	208-230 VAC / 1	15	2" NPT(F)	Yes
1059121230PD	LEH152M2-2	208-230 VAC / 1	15	2" NPT(F)	No
1059121287PD	LEH153M2-2	208-230 VAC / 3	11.4	2" NPT(F)	No
1059121287PG	LEH154M2-2	440-480 VAC / 3	5.7	2" NPT(F)	No
LEH200 SERIES					
10591630PA	LEH202M2-2	230 VAC / 1	18	2" NPT(F)	No
10591687PD	LEH203M2-2	208-230 VAC / 3	13.2	2" NPT(F)	No
10591687PG	LEH204M2-2	440-480 VAC / 3	6.6	2" NPT(F)	No

CERTIFICATIONS

- CSA

Zoeller 800-Series Shark® Grinder Pumps

The Zoeller 800-Series Shark Grinder Pumps are designed for residential use to handle an entire household of "flushable" materials. These pumps are all cast iron for difficult applications where ejectors struggle. Dual blade, angled cutter design provides superior grinding—decreases solids to less than 1/8". The automatic models come with a float switch to automatically turn on/off the pump depending on the fluid level.

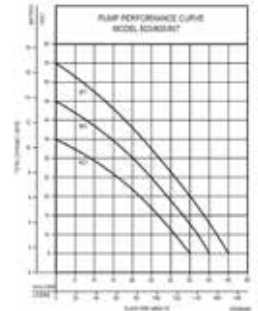

FEATURES & BENEFITS

- World's first integral automatic grinder
- Proven Tri-Slice® cutter technology—three independent cutting channels provide over 250,000 cuts per minute
- 100% Factory-tested

SPECIFICATIONS

MODEL	803	805	807
IMPELLER	Engineered Plastic		
MAX OPERATING TEMPERATURE	130°F (54°C)		
SHAFT	1215 Cold-Rolled Steel		
MECHANICAL SEALS	Carbon & Ceramic		
MAX DISCHARGE HEAD (ft)	35	45	55
MAX FLOW RATE (GPM)	35	40	45
PUMP CORD LENGTH (ft)	15		

CERTIFICATIONS

- CSA

C&M PART #	MFG PART #	MODEL	HP	VOLTS / PHASE	FULL LOAD (Amps)	DISCHARGE SIZE	WEIGHT (lbs)
AUTOMATIC SEWAGE PUMPS							
10610511	803-0001	M803	1/2	115 VAC / 1	7.0	1-1/4" NPT(F)	65
10610711	805-0001	M805	3/4	115 VAC / 1	9.0	1-1/4" NPT(F)	65
10610911	807-0001	M807	1	115 VAC / 1	11.0	1-1/4" NPT(F)	65
MANUAL SEWAGE PUMPS							
10610512	803-0002	N803	1/2	115 VAC / 1	7.0	1-1/4" NPT(F)	65
10610712	805-0002	N805	3/4	115 VAC / 1	9.0	1-1/4" NPT(F)	65
10610912	807-0002	N807	1	115 / 1	11.0	1-1/4" NPT(F)	65



Zoeller 820-Series Shark® Grinder Pumps

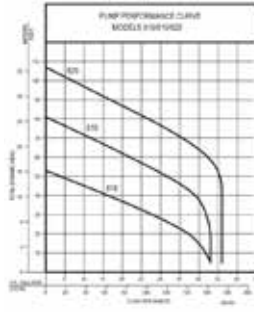

Zoeller 820-Series Shark Grinder Pumps are constructed of corrosion-resistant cast iron with a powder-coated epoxy finish and stainless steel hardware. The hardened stainless steel cutter provides scissor-action style cutting that helps eliminate binding and roping of material around the cutter. Dual blade, angled cutter design provides superior grinding—decreases solids to less than 1/8". The thermally protected, oil-filled motor and external cooling fins allow the pump to run cooler.

FEATURES & BENEFITS

- Vortex impeller
- Proven Tri-Slice® Cutter Technology
- Shreds solids down to 7/32" and smaller

SPECIFICATIONS

IMPELLER	Engineered Plastic with Stainless Steel Insert
MAX OPERATING TEMPERATURE	130°F (54°C)
SHAFT	416 Stainless Steel
MECHANICAL SEALS	Carbon & Ceramic
DISCHARGE:	1-1/4" NPT(F)
MAX DISCHARGE HEAD (ft)	107
MAX FLOW RATE (GPM)	46
PUMP CORD LENGTH (ft)	20

CERTIFICATIONS

- CSA

C&M PART #	MFG PART #	MODEL	HP	VOLTS / PHASE	FULL LOAD (Amps)	DISCHARGE SIZE	WEIGHT (lbs)
10611130PA	820-0004	E820	2	230 VAC / 1	13.7	1-1/4" NPT(F)	88
10611187PA	820-0008	F820	2	230 VAC / 3	9.9	1-1/4" NPT(F)	91
10611187FC	820-0009	G820	2	460 VAC / 3	5.0	1-1/4" NPT(F)	91
10611187PB	820-0010	BA820	2	575 VAC / 3	3.9	1-1/4" NPT(F)	91

Zoeller 840-Series Shark® Auto-Reversing Grinder Pumps

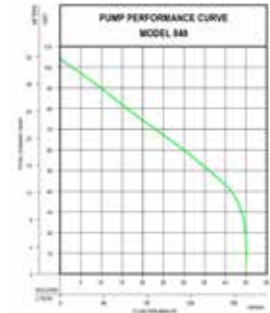

Zoeller 840-Series Shark Grinder Pumps are constructed of corrosion-resistant cast iron with a powder-coated epoxy finish and stainless steel hardware to provide years of reliable service. Pumps feature auto-reversing impeller and cutter assembly that virtually doubles the service life of an ordinary grinder. The hardened 440C stainless steel star shaped cutter provides scissor-action style cutting that helps eliminate binding and roping of material around the cutter. Thermally protected, oil-filled motor and external cooling fins allow the pump to run cooler than most for longer duty cycle.

FEATURES & BENEFITS

- Automatic reversing cutter assembly extends blade life
- Vortex Impeller provides clear path for solids to prevent clogging
- High carbon stainless steel 5-blade cutter for efficient and superior cuts per minute
- Built-in moisture detection probe notifies user of potential seal failure

SPECIFICATIONS

IMPELLER	Ductile Iron
MAX OPERATING TEMPERATURE	130°F (54°C)
SHAFT	416 Stainless Steel
MECHANICAL SEALS	Carbon & Ceramic
DISCHARGE (NPT)	1-1/4" NPT(F)
MAX DISCHARGE HEAD (ft)	125
MAX FLOW RATE (GPM)	59
PUMP CORD LENGTH (ft)	20

CERTIFICATIONS

- CSA

C&M PART #	MFG PART #	MODEL	HP	VOLTS / PHASE*	FULL LOAD (Amps)	DISCHARGE SIZE	WEIGHT (lbs)
10611530PA	840-0004	E840	2	230 VAC / 1	17.2	1-1/4" NPT(F)	137
10611530EM	840-0005	I840	2	200 VAC / 1	20.0	1-1/4" NPT(F)	137
10611587PA	840-0006	F840	2	230 VAC / 3	10.8	1-1/4" NPT(F)	132
10611587EM	840-0007	J840	2	200 VAC / 3	12.3	1-1/4" NPT(F)	132
10611587FC	840-0008	G840	2	460 VAC / 3	5.5	1-1/4" NPT(F)	132

* Single-phase units require a set of capacitors and relay starting components, included in panel.



Liberty LSG200-Series Omnivore® Grinder Pumps

Liberty Pumps

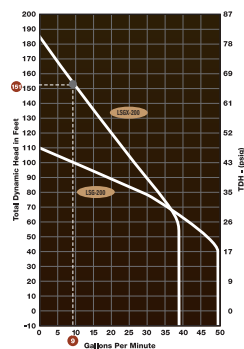

The Liberty LSG-Series Omnivore Grinder Pumps are excellent for use in both residential and commercial sewage applications. These pumps use an industry leading V-Slice® cutting system made from 440 stainless steel (SS) Rockwell 58C that shears difficult solids into smaller particles before discharging. A 2 hp heavy-duty motor, SS shaft and impeller, cast iron housing and clog-free volute make these pumps perfect for use in residential areas, schools, shopping centers and any other area in need of high-pressure sewage pumping. The automatic model comes with a float switch to automatically turn on/off the pump depending on the fluid level. 3-Year Warranty.

SPECIFICATIONS

IMPELLER	300 Series Stainless Steel
MAX LIQUID TEMPERATURE	140°F (60°C)
THERMAL OVERLOAD	221°F (105°C) Single Phase Only
SHAFT	300-Series Stainless Steel
O-RINGS	Buna-N
MECHANICAL SEALS	Unitized Silicon Carbide
MAX DISCHARGE HEAD (ft)	108
MAX FLOW RATE (GPM)	50
PUMP CORD LENGTH (ft)	35 (LSG202M-C); 25 (all other models)

CERTIFICATIONS

- CSA

C&M PART #	MFG PART #	HP	VOLTS / PHASE	DISCHARGE	FULL LOAD (Amps)	WEIGHT (lbs)
AUTOMATIC GRINDER PUMP						
105919PH11PD	LSG202A	2	208-230 VAC / 1	1-1/4" NPT(F)	15	81
MANUAL GRINDER PUMPS						
1058821230PD	LSG202M	2	208-230 VAC / 1	1-1/4" NPT(F)	15	78
105919PI12PD	LSG202M-C	2	208-230 VAC / 1	1-1/4" NPT(F)	15	91
1058821287PD	LSG203M	2	208-230 VAC / 3	1-1/4" NPT(F)	10.6	71
1058821287PG	LSG204M	2	440-480 VAC / 3	1-1/4" NPT(F)	5.3	71

Liberty PRG-Series ProVore® Grinder Pumps

Liberty Pumps

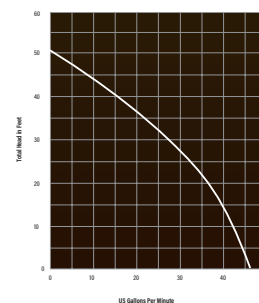

The Liberty PRG-Series ProVore Grinder Pumps are made for continuous underwater use in residential settings. These 1 hp pumps offer higher flow rates and feature heavy cast iron impeller, stainless steel shaft and thermally protected motor for long service life. With the unique patented V-Slice® Cutter Technology, these pumps are designed to shred difficult solids that may jam or clog other grinder pumps in its class. The automatic models come with a float switch to automatically turn on/off the pump depending on the fluid level. 3-Year Warranty

SPECIFICATIONS

IMPELLER	Cast Iron
MAX LIQUID TEMPERATURE	140°F (60°C)
THERMAL OVERLOAD	221°F (105°C)
SHAFT	303-Series Stainless Steel
O-RINGS	Buna-N
MECHANICAL SEALS	Unitized Silicon Carbide
MAX DISCHARGE HEAD (ft)	51
MAX FLOW RATE (GPM)	46
PUMP CORD LENGTH (ft)	10

CERTIFICATIONS

- CSA

C&M PART #	MFG PART #	HP	VOLTS / PHASE	DISCHARGE	FULL LOAD (Amps)	WEIGHT (lbs)
AUTOMATIC GRINDER PUMPS						
10592411OZ	PRG101A	1	115 VAC / 1	2" NPT(F)	12	61
10592411PA	PRG102A	1	230 VAC / 1	2" NPT(F)	6	61
MANUAL GRINDER PUMPS						
10592412OZ	PRG101M	1	115 VAC / 1	2" NPT(F)	12	57
10592412PA	PRG102M	1	230 VAC / 1	2" NPT(F)	6	59



Helpful Tip: Ft. of Head to PSI Conversion

A pump performance curve helps you select the right pump for the specific needs of your application.

2.31 Ft of Head = 1 PSI
1 Ft of Head = 0.43 PSI



Zoeller Pivot® Pump Control Panels

Zoeller Pivot pump controllers are single phase only and include many standard features in a high-quality panel. Smart Hand/Off/Auto (HOA) prevents accidental on or off and provides you with an off-mode reminder. HOA selection modes are Service Off (alarm active), Permanent Off (alarm inactive); Simplex Mode, Duplex Mode (simultaneous pump run enabled or alternating mode where the simultaneous pump run is not enabled). Smart HOA Switch (float smart logic) allows you to select three or four (duplex) floats, SLLH (Stop, Lead, Lag, High Alarm) or SLHL (Stop, Lead, High Alarm, Lag) float order.

Touch-safe user interface features LED indicators for system ready, float switch faults, pump run and float switch. Alarm conditions include high water, high voltage, disabled alarm circuit, float fault, continuous pump run, failed contactor and service off timeout. Top mount red globe alarm displays varying globe patterns for distinct alarm conditions.

FEATURES & BENEFITS

- Rugged NEMA 4X enclosure offers protection from corrosion and extreme environments
- Motor contactors with built-in pump run contacts
- Terminal strip for circuit and alarm power, float switches and aux contacts
- Configurable active/latching side mount horn and test/silence switch
- Hand/Off/Auto control are included for each pump
- Auxiliary output dry contacts (NO-COM-NC) terminals, Form C, 5 A resistive Auxiliary output dry contact (NO-COM-NC) terminals for alarm conditions, Form C, 5 A resistive
- Alarm circuit can be powered separately from circuit breaker
- Pump-run dry contact, normally open
- Separate fuses for alarm and control circuits
- USB port features: pump cycle counter, elapsed time meter, update firmware



SPECIFICATIONS

ENCLOSURE RATING	NEMA 4X
PANEL DIMENSIONS (W x H x D)	10" x 12" x 6" with Lockable Hasp
SIREN RATING (DECIBEL)	95
CONTACTORS	IEC rated
INPUTS	Simplex units up to 3 floats, Duplex units up to 4 floats

CERTIFICATIONS

- CSA certified to standard UL508

C&M PART #	MFG PART #	VOLTAGE (VAC)	PHASE	FULL LOAD (Amps)	BREAKER RATING (AMPS)
SIMPLEX PUMP CONTROL PANELS					
106128263009	31314-0001	120/208/240	1	0 to 7	15
106128273009	31324-0001	120/208/240	1	7 to 15	20
106128283009	31334-0001	120/208/240	1	15 to 20	30
106128293009	31344-0001	120/208/240	1	20 to 30	50
DUPLEX PUMP CONTROL PANELS					
1061322730DS	32124-0001	120	1	7 to 15	20
1061322830DS	32134-0001	120	1	15 to 20	30
106132263009	32314-0001	120/208/240	1	0 to 7	15
106132273009	32324-0001	120/208/240	1	7 to 15	20
106132283009	32334-0001	120/208/240	1	15 to 20	30
106132293009	32344-0001	120/208/240	1	20 to 30	50

SJE Tank Alert® EZ Alarm Systems

FEATURES & BENEFITS

- Two-color molded enclosure offers a distinct look; translucent upper half illuminates in an alarm condition
- Interlocking enclosure amplifies the horn and prevents moisture from entering
- Indicator marks on the bottom of enclosure for easy placement of cord entry locations
- Automatic alarm reset, horn silence switch and alarm test switch
- Includes auxiliary contacts for remote devices



SPECIFICATIONS

VOLTAGE	120 VAC
ENCLOSURE DIMENSIONS	6.7" x 5.3" x 2.5"
ENCLOSURE RATING	3R, Watertight
ALARM HORN (DECIBELS)	82 @ 10 ft
FLOAT SWITCH DIMENSIONS	2.74" Dia x 4.83" L
MAXIMUM WATER DEPTH, FLOAT SWITCH (ft)	30
POWER	120 VAC

CERTIFICATIONS

- CSA

INCLUDES

All models include SignalMaster® control switch, normally open, mechanical, 15-ft cable, pipe clamp mounting; Select from optional model that includes premounted terminal block so enclosure can also be used as a junction box for splicing pump, pump switch, and pump power; meets NEC standard for junction boxes

C&M PART #	MFG PART #	DESCRIPTION	PREMOUNTED TERMINAL BLOCK
400247	1036589	TAEZ-01H, Tank Alert EZ with 15-ft SignalMaster High Level	No
400248	1036592	TAEZ-01HTB, Tank Alert EZ with 15-ft SignalMaster High Level Terminal Block	Yes

Zoeller Pivot® Pro Pump Control Panels

Use the Zoeller Pivot® Pro Pump Control Panels with advanced features to control your pumps. The Pivot Pro panels feature a user-friendly interface with LCD screen/menu, buttons, LEDs and seal fail adjustment screw. Controllers also includes an alternator 1-2 selector switch (lead/lag for duplex pump panels), thermal cutout indicator and dry contact alarms with seal/thermal conditions.

Smart Hand/Off/Auto (HOA) prevents accidental on or off and provides you with an off-mode reminder. HOA selection modes are Service Off (alarm active), Permanent Off (alarm inactive); Simplex Mode, Duplex Mode (simultaneous pump run enabled or alternating mode where the simultaneous pump run is not enabled). Smart HOA Switch (float smart logic) allows you to select three or four (duplex) floats, SLLH (Stop, Lead, Lag, High Alarm) or SLHL (Stop, Lead, High Alarm, Lag) float order.

Touch-safe user interface features LED indicators for system ready, float switch faults, pump run and float switch indicators. Alarm conditions include high water, high voltage, disabled alarm circuit, float fault, continuous pump run, failed contactor and service off timeout.

Additional alarms included are: seal fail (moisture) alarm, adjustable sensitivity, thermal indicator trip alarm and tripped overload (3-ph only). Top mount red globe alarm displays varying globe patterns for distinct alarm conditions.

FEATURES & BENEFITS

- LCD Display with button user interface menu: configure keypad lock for security, review pump cycle and elapsed run times, continuous run alarm timer, latching/active horn
- Rugged NEMA 4X enclosure offers protection from corrosion and extreme environments
- Motor IEC contactors with built-in pump run contacts, circuit breakers (1-ph only), overloads (3-ph only)
- Terminal strip for circuit and alarm power, float switches, aux contacts
- Configurable active/latching side mount horn, test/silence switch
- Hand/Off/Auto control are included for each pump
- Auxiliary output dry contacts (NO-COM-NC) terminals for alarm conditions, Form C, 5 A resistive
- Alarm circuit can be powered separately from circuit breaker
- Pump-run dry contact, normally open
- Separate fuses for alarm and control circuits protects the pump panel
- Multitap 200/230/460 transformer on 3-ph models
- Terminals for 120 VAC control power/alarm power, up to four float switches (duplex), pump input power
- Thermal cutout and seal fail indicators

SPECIFICATIONS

ENCLOSURE RATING	NEMA 4X
PANEL DIMENSIONS (W x H x D)	12" x 14" x 6" with Lockable Hasp (Part# 1061474187PF: 14" x 16" x 7")
SIREN RATING (DECIBEL)	95
CONTRACTORS	IEC rated
INPUTS	Simplex units up to 3 floats, Duplex units up to 4 floats, seal fail and thermal connections for each pump



CERTIFICATIONS

- CSA certified to standard UL508

C&M PART #	MFG PART #	VOLTAGE (VAC)	PHASE	FULL LOAD (Amps)	BREAKER/OVERLOAD RATING (Amps)
SIMPLEX PUMP CONTROL PANELS					
4002352630PC	11314-0001	120/208/240	1	0 to 7	15
4002352730PC	11324-0001	120/208/240	1	7 to 15	20
4002352830PC	11334-0001	120/208/240	1	15 to 20	30
4002352930PC	11344-0001	120/208/240	1	20 to 30	50
106138318710	114A4-0001	208/240/480	3	1.0 to 1.6	1.0 to 1.6
106138328710	114B4-0001	208/240/480	3	1.6 to 2.5	1.6 to 2.5
106138338710	114C4-0001	208/240/480	3	2.5 to 4.0	2.5 to 4.0
106138348710	114D4-0001	208/240/480	3	4.0 to 6.3	4.0 to 6.3
106138358710	114E4-0001	208/240/480	3	6 to 10	6 to 10
106138368710	114F4-0001	208/240/480	3	9 to 14	9 to 14
106138378710	114G4-0001	208/240/480	3	13 to 18	13 to 18
106138388710	114H4-0001	208/240/480	3	17 to 23	17 to 23
106138398710	114Q4-0001	208/240/480	3	20 to 25	20 to 25
DUPLEX PUMP CONTROL PANELS					
4002392730OZ	12124-0001	120	1	7 to 15	20
4002392830OZ	12134-0001	120	1	15 to 20	30
4002392630PC	12314-0001	120/208/240	1	0 to 7	15
4002392730PC	12324-0001	120/208/240	1	7 to 15	20
4002392830PC	12334-0001	120/208/240	1	15 to 20	30
4002392930PC	12344-0001	120/208/240	1	20 to 30	50
106147318710	124A4-0001	208/240/480	3	1.0 to 1.6	1.0 to 1.6
106147328710	124B4-0001	208/240/480	3	1.6 to 2.5	1.6 to 2.5
106147338710	124C4-0001	208/240/480	3	2.5 to 4	2.5 to 4
106147348710	124D4-0001	208/240/480	3	4 to 6.3	4 to 6.3
106147358710	124E4-0001	208/240/480	3	6 to 10	6 to 10
106147368710	124F4-0001	208/240/480	3	9 to 14	9 to 14
106147378710	124G4-0001	208/240/480	3	13 to 18	13 to 18
106147388710	124H4-0001	208/240/480	3	17 to 23	17 to 23
106147398710	124Q4-0001	208/240/480	3	20 to 25	20 to 25
106147408710	124R4-0001	208/240/480	3	23 to 32	23 to 32
106147418710	12404-0001	208/240/480	3	30 to 40	30 to 40



Tsurumi Submersible Trash Pumps



Tsurumi HS-Series Trash Pumps are designed to pump water containing sand, solids and debris with minimal wear and clogging. Compact yet powerful pumps are great for use for sediment removal from small sumps or basins and other industrial/commercial site drainage. Cast iron body and urethane semi vortex impeller provide excellent durability. Select from manual pumps or “Automatic” (Z) pumps that come with integrated float switches.

FEATURES & BENEFITS

- For use in commercial, industrial wastewater and site drainage
- Built-in shaft mounted agitator suspends solids
- Urethane semi vortex impeller for maximum durability and pump performance
- Dual inside mechanical seal with SiC faces for longer life
- Oil lifter provides lubrication of the seal faces
- V-ring seal design protects mechanical seal from abrasive particles

SPECIFICATIONS

SOLIDS HANDLING	1/4"
IMPELLER	Urethane Semi Vortex
PUMP BODY	Cast Iron
SEAL	Dual Inside Silicon Carbide
CORD LENGTH (ft)	20 HS(Z)2 Models, 32 HS(Z)3 Models
MIN OPERATING WATER LEVEL (in.)	3-1/2 Manual Models, 15 (HSZ2), 19 (HSZ3)
MAX OUTPUT (GPM)	53 HS(Z)2 Models, 60 HS(Z)3 Models
MAX DISCHARGE HEAD (ft)	39 HS(Z)2 Models, 38 HS(Z)3 Models

CERTIFICATIONS

- ETL

C&M PART #	MFG PART #	TYPE	DISCHARGE SIZE	HP	VOLTS / PHASE	FULL LOAD (Amps)	WEIGHT (lbs)
111179	HS2.4S	Manual	2" NPT(M)	1/2	115 / 1	5.4	25
111180	HS3.75S	Manual	3" NPT(M)	1	115 / 1	9.6	43
111181	HSZ2.4S	Automatic	2" NPT(M)	1/2	115 / 1	5.4	30
111182	HSZ3.75S	Automatic	3" NPT(M)	1	115 / 1	9.6	49

REPLACEMENT PARTS & ACCESSORIES

C&M PART #	DESCRIPTION
10234201BC50	2" x 50 ft Blue PVC Discharge Hose, M x F Threads
10234201BC87	3" x 50 ft Blue PVC Discharge Hose, M x F Threads

Koshin Submersible Trash Pump



Koshin's Submersible Trash Pump is perfect for municipal, construction and industrial use. Pump only measures 10" in diameter making it great for manhole and vault draining. Water is channeled through the outer wall which cools the motor and provides you with a pump that has maximum endurance.

FEATURES & BENEFITS:

- Lightweight, compact and easy to carry
- Thermal protected motor
- Oil bathed double silicon carbide mechanical seal allows for periods of dry run
- Fits into small diameter holes (10" pump diameter)
- Completely rebuildable

SPECIFICATIONS

SOLIDS HANDLING	Up to 5/8"
IMPELLER	Cast Iron
SEAL	Double Silicon Carbide Mechanical
CORD LENGTH (ft)	20
MIN OPERATING WATER LEVEL (in.)	5-1/2
MAX OUTPUT (GPM)	80
MAX DISCHARGE HEAD (ft)	33

C&M PART #	MFG PART #	TYPE	DISCHARGE SIZE	HP	VOLTS / PHASE	FULL LOAD (Amps)	WEIGHT (lbs)
100939	PKS-65011	Manual	2" NPT(M)	1/2	115 / 1	7	36

REPLACEMENT PARTS & ACCESSORIES

C&M PART #	DESCRIPTION
10234201BC50	2" x 50 ft Blue PVC Discharge Hose, M x F Threads
10234202BC50	2" x 50 ft Blue PVC Discharge Hose, M x F, Quick Alum (Cam & Groove) Couplings
102406	2" Aluminum Quick Coupling, Part 'A' Male Adapter x NPT(F) Threads

SUCTION & DISCHARGE HOSES

For a complete selection of suction and discharge hoses along with accessories, see our **Hose** product category in this catalog and our website.



AMT Electric Sewage & Trash Pumps



AMT Electric Sewage/Trash Pumps are designed for trouble-free and economical handling of solids-laden liquids and slurries. Cast iron construction with two vane stainless steel self-cleaning impellers, abrasion-resistant silicon carbide mechanical seals and Buna-N O-rings and check valves provide durability and long service life. Built-in check valve allows pump to reprime automatically in an open system without the foot valve. The solids handling capabilities of the pumps make them ideally suited for a variety of industrial applications including: sewage treatment, canneries, chemical processing, wineries, tanneries, meat packing, breweries, pulp, wood chips, process water, sludge and slime, waste water, white water and other applications. Pumps are available in three NPT port sizes: 2", 3" or 4".

FEATURES & BENEFITS

- Operate pump up to 180°F
- Self-priming to 20 ft
- Stainless steel semi-open, clog-resistant impeller
- Removable cast iron volute/wearplate
- 3" and 4" models feature front cleanout easy and quick cleaning

SPECIFICATIONS

IMPELLER	Stainless Steel
PUMP BODY	Cast Iron
SHAFT SEAL	Silicon Carbide / Viton mechanical seal

C&M PART #	MFG PART #	SUCTION/ DISCHARGE	HP	VOLTS / PHASE	FULL LOAD (AMPS)	WEIGHT (lbs)
10585587PA	316B-95	2" NPT(F)	3	230/1	16	94
10585587PF	316A-95	2" NPT(F)	3	230/460/3	8/4	87
105855F9PA	393B-95	2" NPT(F)	5	230/1	20	189
105855F9PF	393A-95	2" NPT(F)	5	230/460/3	17/9	173
105855OMPA	394H-95	3" NPT(F)	7-1/2	230/1	31	295
105855OMPFP	394G-95	3" NPT(F)	7-1/2	230/460/3	22/11	245
105855N8PA	394K-95	3" NPT(F)	10	230/1	40	360
105855N8PFP	394J-95	3" NPT(F)	10	230/460/3	26/13	270
105855S2PFP	399D-95	4" NPT(F)	15	230/460/3	47/24	275

Koshin STH Engine Driven Semi-Trash Pumps

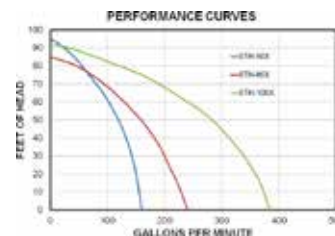

Koshin's STH Series, Engine Driven, Semi-Trash Pumps are designed for use under tough site conditions. Spheroidal graphite ductile cast iron impellers and volutes offer durability and long service life. Silicon carbide mechanical seals provide excellent abrasive resistance and can handle muddy, sandy or debris-filled water. These pumps are ideal for construction/municipal applications including dewatering and pumping out manholes, meter vaults and more.

FEATURES & BENEFITS

- Honda GX series commercial engines provide superb performance
- Standard low oil shutdown feature protects engine
- Mounted in a steel roll cage for protection and ease of handling

SPECIFICATIONS

ENGINE	Honda, Gas Powered
IMPELLER	Cast Iron
PUMP BODY	Aluminum
SHAFT SEAL	Silicon Carbide

C&M PART #	MFG PART #	SUCTION/ DISCHARGE	ENGINE	HP	FULL LOAD RUN TIME (hrs)	SOLIDS HANDLING	WEIGHT (lbs)
10093350	STH-50X	2" NPT	Honda GX120	3.5	2.5	3/8"	56
10093387	STH-80X	3" NPT	Honda GX160	4.8	2.5	3/8"	76
100933C1	STH-100X	4" NPT	Honda GX240	7.9	2.5	3/8"	132

REPLACEMENT PARTS & ACCESSORIES

C&M PART #	SIZE	HOSE KITS
1023160150	2"	M x F Threads
1023160187	3"	M x F Threads
10231601C1	4"	M x F Threads
1023200350	2"	Quick Coupling
102320387	3"	Quick Coupling
10232003C1	4"	Quick Coupling

Hose Kits Note:
Includes 20 ft PVC Suction Hose Assembly, 50 ft Blue PVC Discharge Hose Assembly, Spanner Wrench (M&F Kits only), Steel Strainer (Square Hole), (2) Aluminum Part 'A' Adapters (Quick Coupling Kits only). Quick Coupling Suction Hose is 'C' x Nipple, Discharge Hose is 'C' x 'E'.



Koshin KTH Engine Driven Trash Pumps

Koshin KTH Series Engine Driven Trash Pumps are great for tough debris conditions, construction, municipal applications and general water removal including pumping out ditches and excavations. Silicon carbide mechanical seals offer increased abrasive resistance, longer service life and less maintenance. The removable front covers provide easy and quick access for cleaning out debris without disassembly of hoses.

FEATURES & BENEFITS

- Designed to handle large solids and trash
- Honda GX series commercial engines offer superb performance
- Low oil shutdown feature protects engine
- Mounted in a steel roll cage for protection and ease of handling
- Easy opening covers to clean out debris
- Hi-chrome cast iron impellers provide extreme durability
- Includes wrench that opens the removable front cover bolts

SPECIFICATIONS

ENGINE	Honda, Gas Powered
IMPELLER	Cast Iron
PUMP BODY	Aluminum
SHAFT SEAL	Silicon Carbide

C&M PART #	MFG PART #	SUCTION/DISCHARGE	ENGINE	HP	FULL LOAD RUN TIME (hrs)	SOLIDS HANDLING	WEIGHT (lbs)
10093650	KTH50X	2" NPT(M)	Honda GX160	5-1/2	2	1"	110
10093687	KTH80S	3" NPT(M)	Honda GX270	8	2	1-1/2"	160
100936C1	KTH100S	4" NPT(M)	Honda GX390	11	1.5	2"	200



10093650

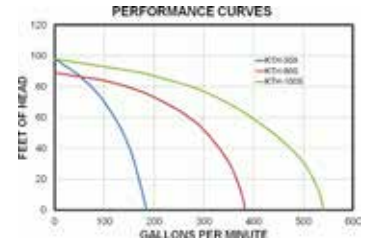

10093687



100936C1

REPLACEMENT PARTS & ACCESSORIES

C&M PART #	SIZE	HOSE KITS
1023160150	2"	M x F Threads
1023160187	3"	M x F Threads
10231601C1	4"	M x F Threads
1023200350	2"	Quick Coupling
102320387	3"	Quick Coupling
10232003C1	4"	Quick Coupling

Hose Kit Notes:

Includes 20 ft PVC Suction Hose Assembly, 50 ft Blue PVC Discharge Hose Assembly, Spanner Wrench (M&F Kits only), Steel Strainer (Square Hole), (2) Aluminum Part 'A' Adapters (Quick Coupling Kits only). Quick Coupling Suction Hose is 'C' x Nipple, Discharge Hose is 'C' x 'E.'

Core & Main PVC Water Suction/Discharge Hose Kit

These PVC Water Suction/Discharge Hose Kits ship completely packaged in a box with both a suction and a discharge hose, as well as a steel strainer. Choose from threaded fittings or kits with quick connect fittings for added convenience.



INCLUDES

20 ft PVC suction hose assembly, 50 ft PVC discharge hose assembly, Spanner wrench (M&F kits only), Steel strainer (square hole), (2) Aluminum part 'A' adapters (quick coupling kits only)

NOTE: Quick Coupling suction hose is 'C'xNipple, discharge hose is 'C'x'E'

C&M PART #	SIZE (in)	COUPLINGS	C&M PART #	SIZE (in)	COUPLINGS
1023160140	1-1/2	M&F Thread	1023200340	1-1/2	Quick Coupling
1023160150	2	M&F Thread	1023200350	2	Quick Coupling
1023160187	3	M&F Thread	1023200387	3	Quick Coupling
10231601C1	4	M&F Thread	10232003C1	4	Quick Coupling

CHECK US OUT ONLINE

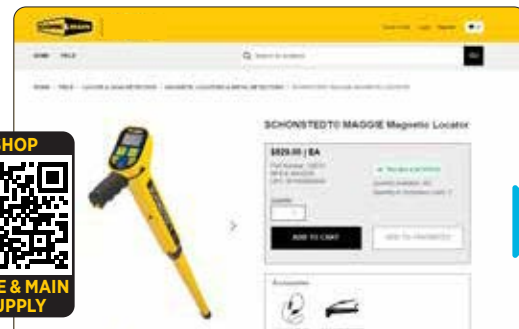

We're always adding new products. Visit supply.coreandmain.com for our latest additions.

AMT Engine Driven Trash Pumps

AMT Engine Driven Trash Pumps feature reliable Honda engines and are designed for applications which require high flow efficiency, solids handling capability and abrasion resistance.

These pumps easily handle liquids with solids content or dissolved solids and debris. The 3 and 4" port size models feature a discharge that rotates in 90-degree increments for convenience.

FEATURES & BENEFITS

- Solids handling and dirty water design
- Heavy-duty steel roll frame for added durability
- Honda GX commercial engines provide superb performance
- Low-oil shutdown feature protects engine
- Self-priming to 20 ft (2" model) or 26 ft (3 and 4" models) with built-in Viton® check valve
- C&M part #'s #10070187 and #100701C1, discharge rotates in 90-degree increments

INCLUDES

All pumps include a steel suction strainer. C&M part #10070150 includes two NPT(M) pipe nipples and 2" street elbow

SPECIFICATIONS

ENGINE	Honda, Gas Powered
IMPELLER	Cast Iron
PUMP BODY	Cast Aluminum
SHAFT SEAL	Silicon Carbide / Viton

C&M PART #	MFG PART #	SUCTION/DISCHARGE	ENGINE	HP	FULL LOAD RUN TIME (hrs)	SOLIDS HANDLING	WEIGHT (lbs)
10070150	3932-95	2" NPT(F)	Honda GX160	5-1/2	2	1"	110
10070187	3S9XHR	3" NPT(M)	Honda GX270	8	2.5	1-1/2"	145
100701C1	4S13XHR	4" NPT(M)	Honda GX390	13	2.5	2"	200



REPLACEMENT PARTS & ACCESSORIES

C&M PART #	SIZE	DESCRIPTION
WHEEL KIT		
400224	Fits all models	AMT Wheel Kit Model C402-90
HOSE KITS		
1023160150	2"	M&F Thread
1023160187	3"	M&F Thread
10231601C1	4"	M&F Thread
1023200350	2"	Quick Coupling
102320387	3"	Quick Coupling
10232003C1	4"	Quick Coupling

Hose Kits Note:
Quick Coupling Suction Hose is 'C' x Nipple, Discharge Hose is 'C' x 'E'. Includes 20 ft PVC Suction Hose Assembly, 50 ft Blue PVC Discharge Hose Assembly, Spanner Wrench (M&F Kits only), Steel Strainer (Square Hole), (2) Aluminum Part 'A' Adapters (Quick Coupling Kits only). Quick Coupling Suction Hose is 'C' x Nipple, Discharge Hose is 'C' x 'E'.



Helpful Tip: PVC Water Suction Hose Kit

When purchasing a trash pump consider also purchasing a PVC Water Suction Hose Kit which includes both the suction and discharge hose, strainer and fittings all in on box.

In general terms, the pumps are able to handle solids that are 1/2 the size of the inlet/outlet.

AMT Wheel Kit



AMT Wheel Kit can be used with any AMT Engine Driven Pumps that have a roll cage. Scratch resistant powder coated steel. Wheel Kit includes 10" semi-pneumatic tires on steel wheels with clamps and steel handles for universal mounting to frame.

C&M PART #	MFG PART #	DESCRIPTION	WEIGHT (lbs)
400224	C402-90	AMT Wheel Kit	25



AMT 4" Engine Driven Trash Pump with 2-Wheel Cart

Easily wheel this 4" self-priming trash pump where you need it. Pump comes mounted on a dolly with 16" ball-bearing wheels for easy transport. With a large 4" port size, it is designed for applications which require high flow and solids handling capability. Heavy-duty sand cast aluminum components featuring removeable/replaceable cast iron volutes, impellers and wear plates ensure durability and long service life.



FEATURES & BENEFITS

- Cast Iron discharge port rotates in 90° increments for convenience
- Handles up to 2" max solids
- Front cleanout with cast aluminum handles permits easy removal of trash and debris
- Self priming up to 20 ft with built-in Buna-N check valve

INCLUDES

Steel suction strainer

SPECIFICATIONS

ENGINE	Honda, Gasoline
IMPELLER	Cast Iron
PUMP BODY	Cast Aluminum Casing, Seal Plate and Bell Housing
SHAFT SEAL	Viton®/Silicon Carbide Mechanical Seal & Buna-N O-Ring/Gasket

C&M PART #	MFG PART #	SUCTION/DISCHARGE	ENGINE	HP	FULL LOAD RUN TIME (hrs)	SOLIDS HANDLING	WEIGHT (lbs)
400222	3994-96	4" NPT(F)	Honda GX390	13	2.5	2"	300

REPLACEMENT PARTS & ACCESSORIES

C&M PART #	SIZE (in)	HOSE KITS
10231601C1	4"	M x F Threads
10232003C1	4"	Quick Coupling

Hose Kits Note:
Includes 20 ft PVC Suction Hose Assembly, 50 ft Blue PVC Discharge Hose Assembly, Spanner Wrench (M&F Kits only), Steel Strainer (Square Hole), (2) Aluminum Part 'A' Adapters (Quick Coupling Kits only), Quick Coupling Suction Hose is 'C' x Nipple, Discharge Hose is 'C' x 'E'.

AMT 6" Trailer-Mounted Engine Driven Trash Pump

The AMT 6" Trailer-Mounted Trash Pump is designed for applications requiring high-volume flow and solids/debris handling capabilities. The pump is equipped with a precision lapped mechanical shaft seal to reduce the likelihood of leakage, and a clog resistant impeller. Units are used to handle water containing stones, sticks, mud and other solids (up to 20% by volume). The V-Twin Honda engine includes oil alert feature that protects the engine. The heavy-duty sand-cast aluminum with cast iron and stainless steel internal parts provide excellent wear resistance and durability. A patented built-in slide mechanism features nylon and powder coated steel components that permit servicing, repairing and cleaning the entire pump without removing hoses or pump components from the trailer. Digital tachometer/hourmeter keeps track of service life so you can be proactive with maintenance thus minimizing downtime.



FEATURES & BENEFITS

- Cast iron adapter, volute and suction/discharge manifold for durability
- Handles up to 3" max solids
- Self-priming up to 20 ft with built-in Buna-N check valve
- DOT Approved trailer comes complete with lights, fenders, safety chains and 2" ball hitch
- Seal wash feature for extended seal life
- Solids handling and dirty water design

INCLUDES

Steel suction strainer and nipple

Note: Requires 12 VDC battery; BCI Group 24, minimum of 500 CCA (Cold Crank Amps); battery box cables setup for automotive post type connections.

SPECIFICATIONS

ENGINE	Honda, Gasoline
IMPELLER	Stainless Steel, Corrosion Resistant, Heavy-Duty
PUMP BODY	Cast Aluminum Casing, Seal Plate and Bell Housing
SHAFT SEAL	Silicon Carbide Mechanical Seal and Buna-N O-Rings and Check Valve

C&M PART #	MFG PART #	SUCTION/DISCHARGE	ENGINE	HP	FULL LOAD RUN TIME (hrs)	SOLIDS HANDLING	WEIGHT (lbs)
400223	5585-H6	6" NPT(M)/NPT(F)	Honda V-Twin	24	9	3"	1000

Note: See our Hose product category for Suction and Discharge hoses.

AMT Diaphragm Pumps

These AMT Diaphragm Pumps feature a 2-stage, heavy-duty forged gear driven transmission. Often referred to as mud or sludge pumps, they are ideal for pumping mud, slurry, sewage, thick liquids that have the ability to flow and dewatering a main break excavation or pumping sludge. Choose from electric or engine-driven models. Heavy-duty forged gear-driven transmission is designed to operate pump at 40 strokes per minute for electric models and 60 strokes per minute for engine-driven models.

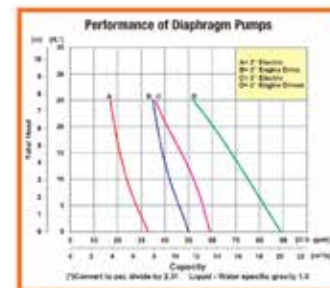

FEATURES & BENEFITS

- Can run dry eliminating the need to run pump on/off ideal for excavations
- Sand cast aluminum construction for portability and durability
- Thermoplastic Santoprene® diaphragm
- Modular component design permits easy maintenance and cleanout
- 90° rotatable base on all models
- Built-in check valve ensures self-priming to 20 ft after initial prime

INCLUDES

NPT steel suction strainer, two NPT nipples and a wheel kit for portability

SPECIFICATIONS

DIAPHRAGM	Santoprene
FLIP VALVES	Neoprene
PUMP BODY	Aluminum
MAX TEMPERATURE	180°F (82°C)

C&M PART #	MFG PART #	SUCTION/DISCHARGE SIZE	HP	POWER SOURCE	SOLIDS	WEIGHT (lbs)
100704	338E-96	2" NPT(F)	1.5	115/230 VAC, 1-Phase	1-1/4"	175
100705	338G-96	2" NPT(F)	3.2	Honda GX120, Gas	1-1/4"	165
100706	337E-96	3" NPT(F)	1.5	115/230 VAC, 1-Phase	1-5/8"	185
100707	337G-96	3" NPT(F)	3.2	Honda GX120, Gas	1-5/8"	175
100708	337H-96	3" NPT(F)	4.8	Honda GX160, Gas	1-5/8"	185

REPLACEMENT PARTS & ACCESSORIES

C&M PART #	HOSE KITS
1023160150	2" x 20 ft PVC Suction Hose, 2" x 50 ft Blue PVC Discharge Hose Assemblies, M x F Threads, Spanner Wrench and Steel Strainer
1023160187	3" x 20 ft PVC Suction Hose, 3" x 50 ft Blue PVC Discharge Hose Assemblies, M x F Threads, Spanner Wrench and Steel Strainer

AMT® Hand Diaphragm Pump

AMT Hand Diaphragm Pump offers a simple way to dispense debris-free liquids and chemicals. This pump is an ideal solution in transferring liquids in marine, sanitation, home and industrial applications.



SPECIFICATIONS

CONSTRUCTION	Derlin Plastic
HANDLE MATERIAL	Rugged Aluminum
HANDLE	Adjustable (12 Orientations)
DIAPHRAGM AND FLAPPER	Buna-N
MAX TEMPERATURE	130°F (54°C)
DISCHARGE*	1" / 1-1/2" Smooth Hose
MAX LIFT (ft)	12
MAX DISCHARGE HEAD (ft)	30
FLOW RATE	12 GPM @ 90 Strokes/min
WEIGHT (lbs)	3
MAX PRESSURE (PSI)	2

*Discharge port kit for both 1" and 1-1/2" connections are included.

C&M PART #	MFG PART #	DESCRIPTION
105832	HP01-99	Hand Diaphragm Pump

FTI EFV Drum Pump Kits

Designed for use as a medium volume transfer pump with water treatment chemicals like sodium hypochlorite, Finish Thompson EFV-Series Drum/Barrel Pumps are an economical and lightweight choice for light-duty fluid transfer. These pumps reduce risk, as they are designed to withstand harsh chemicals and keep them safely contained during transfers, effectively mitigating operator and company risk. They are compact and easily portable for various tasks throughout a facility, making them an ideal replacement for hand pumps. Kits include everything in one convenient carton to quickly transfer liquids from a drum. Choose from electric motor or air-operated kits.



FEATURES & BENEFITS

- Takes up with minimal footprint to conserve space or for use in smaller settings
- Easily transfer high volumes of fluids quickly and effectively to improve productivity
- Durable pumps offer longevity and low maintenance throughout to save you money
- Built-in strainer protects pump

INCLUDES

Motor, drum pump tube, PVDF nozzle, wall mounting bracket and 6-ft ultra-high molecular weight polyethylene hose

SPECIFICATIONS

MOTOR TYPE	115 VAC MOTOR	12 VDC MOTOR	AIR MOTOR
PUMP TUBE MATERIAL	Pure Polypropylene/PVDF		
PUMP TUBE DIAMETER	1-5/16"		
PUMP DISCHARGE HOSE	5-ft, ultra-high molecular weight polyethylene hose		
MAX FLOW RATE (GPM)	17	14	15
MAX DISCHARGE HEAD (ft)	20	13	17
MAX VISCOSITY (cP)	300	100	300
MAX SPECIFIC GRAVITY	1.6		
DISCHARGE SIZE	3/4" Hose Barb		
HOSE SIZE	3/4"		
MOTOR POWER CORD LENGTH (ft)	12	—	—
MOTOR RATING	ODP/Splashproof, IP24		—

Note: All testing performed with water at 68°F, in a full container. Actual performance may vary by +/-10%. Actual performance will decrease with increased fluid viscosity and specific gravity.

CERTIFICATIONS

- 115 VAC Electric motor, QPS; 12 VDC motor, CE

C&M PART #	MFG PART #	TUBE LENGTH	MOTOR TYPE
401276	111621	40"	Two-Speed, 115 VAC, Electric, ODP/IP24
401277	111623	40"	Two-Speed, 12 VDC, Lithium-ion Battery, ODP w/ USA Plug Charger
401278	111625	40"	Two-Speed, 12 VDC, Lithium-ion Battery, ODP w/ 12 V Car Adapter
401279	111626	40"	Variable Speed, Air Motor, Requires 27 cfm @ 40 PSI

REPLACEMENT PARTS & ACCESSORIES

C&M PART #	MFG PART #	REPLACEMENT DRUM PUMP TUBES
401287	DEFV003	EFV40 Drum Pump Only, 40" Tube Length, Pure Polypropylene/PVDF
401288	DEFV010	EFV54 Drum Pump Only, 54" Tube Length, Pure Polypropylene/PVDF

AMT® Rotary Drum Pumps

Easily dispense liquids from drums with the AMT Rotary Drum Pumps. Pumps are self-priming and designed to transfer debris-free liquids. Use the Ryton® drum pump for transferring aggressive chemicals; polypropylene pump is ideal for dispensing many organic acids and alcohols. All units include discharge spout, bung adapter and suction tube assembly for a quick and simple connection.



INCLUDES

1" OD Ryton discharge spout assembly, 1" ID x 45" L Ryton suction tube assembly and 2" bung adapter

SPECIFICATIONS

C&M PART #	105830	105831
CONSTRUCTION	Ryton with Ryton Rotor and Vanes	Polypropylene with Ryton Rotor and Vanes
SEAL	Teflon®	
MAX TEMPERATURE	180° F (82° C)	130°F (54°C)
FLOW RATE	6 GPM @ 70 RPM (11 oz/Stroke)	
WEIGHT (lbs)	8	12

C&M PART #	MFG PART #	DESCRIPTION
105830	4942-99	Rotary Drum Pump
105831	4946-99	Rotary Drum Pump

FTI SFV Drum Pump Kits

High-volume transfer, high-performance Finish Thompson SFV-Series Drum/Barrel Pumps are designed for use with water treatment chemicals (alum, ferric chloride, hydrochloric acid, fluoride, permanganates, sodium bisulfate, sodium hypochlorite, polymers). These pumps reduce risk, as they are designed to withstand harsh chemicals and keep them safely contained during transfers, effectively mitigating operator and company risk. They are compact and easily portable for various tasks throughout a facility, making them an ideal replacement for hand pumps. Kits include everything in one convenient carton to quickly transfer liquids from a drum. Choose from electric motor or air-operated kits.

FEATURES & BENEFITS

- Takes up with minimal footprint to conserve space or for use in smaller settings
- Easily transfer high volumes of fluids quickly and effectively to improve productivity
- Durable pumps offer longevity and low maintenance throughout to save you money
- Built-in strainer protects pump
- Electric motor kit versions feature variable-speed and solid state overload protection

INCLUDES

Motor, drum pump tube, PVDF nozzle, wall mounting bracket, bung adapter and 6-ft ultra-high molecular weight polyethylene hose

SPECIFICATIONS

MOTOR TYPE	ELECTRIC MOTOR	AIR MOTOR
PUMP TUBE MATERIAL	Pure polypropylene /PVDF tube with FKM elastomers	
PUMP TUBE DIAMETER (in)	1.6	
PUMP DISCHARGE HOSE	6-ft, ultra-high molecular weight polyethylene hose	
MAX FLOW RATE (GPM)	37	31
MAX DISCHARGE HEAD (ft)	50	32
MAX VISCOSITY (cP)	1000	1200
MAX SPECIFIC GRAVITY	1.84	2.0
DISCHARGE SIZE	1" Hose Barb	
HOSE SIZE	1"	
POWER CORD LENGTH (ft)	12, with plug	—

Note: All testing performed with water at 68°F, in a full container. Actual performance may vary by +/-10%. Actual performance will decrease with increased fluid viscosity and specific gravity.



CERTIFICATIONS

- Electric Motor, QPS; Air Motor, CE

C&M PART #	MFG PART #	TUBE LENGTH	MOTOR TYPE
401280	111666	40"	Variable Speed, 115 VAC, TEFC/IP55
401281	111667	48"	Variable Speed, 115 VAC, TEFC/IP55
401282	111670	40"	Variable Speed Air Motor, Requires 80 to 100 PSI @15 to 32 cfm
401283	111671	48"	Variable Speed Air Motor, Requires 80 to 100 PSI @15 to 32 cfm

REPLACEMENT PARTS & ACCESSORIES

C&M PART #	MFG PART #	REPLACEMENT DRUM PUMP TUBES
401299	DSFV003	40" Tube Length, Pure Polypropylene, PVDF
401300	DSFV005	48" Tube Length, Pure Polypropylene, PVDF
401301	DSFV009	60" Tube Length, Pure Polypropylene, PVDF
401302	DSFVV003	40" Tube Length, Pure PVDF
401303	DSFVV005	48" Tube Length, Pure PVDF
401304	DSFVV009	60" Tube Length, Pure PVDF

Cherne® Aqua-Loc® Hydrostatic Test Pumps

The Aqua-Loc Hydrostatic Test Pumps are designed for pressure testing water lines and sewer force mains as prescribed by AWWA Standard C600 Installation of Ductile-Iron Water Mains and C605 Installation of PVC Pressure Pipe. Test pumps are designed to be the most user friendly in the industry.



FEATURES & BENEFITS

- Self-priming and handles up to 10% chlorine solutions
- Test gauge and pressure regulator make for easy adjustments
- Pulsation dampener means no need for a surge tank
- Brass inline strainer and filter are easy to clean
- Color-coded quick-connect fittings make setup and break down easier

INCLUDES

12 ft output hose and 10 ft intake hose

C&M PART #	MFG PART #	ENGINE	MAX PSI	GPM
100959	278058	Briggs & Stratton	550	9.5
100960	278068	Honda	550	9.5
100961	278178	Honda	290	35

REPLACEMENT PARTS & ACCESSORIES

C&M PART #	MFG PART #	DESCRIPTION
103837	031198	Replacement Output Hose without Disconnects, 12 ft Length
103838	022768	Replacement Strainer
104584	45918	Optional Wheel Kit
104587	39168	Optional 16 Gallon Water Tank



AMT® High-Volume Straight Centrifugal Pumps



AMT High-Volume Straight Centrifugal Pumps are excellent at handling solids and dirty water in liquid and chemical transfer, heating and cooling, recirculation, booster service and other industrial applications. Semi-open impeller with self-cleaning ability can pump solids up to 1/4" in diameter. Adjust discharge position in 90 degree increments with vent and drain plugs for all positions.

SPECIFICATIONS

SOLIDS HANDLING	Up to 1/4"
CONSTRUCTION	Cast Iron
IMPELLER	Self-Cleaning Stainless Steel
MOTOR	TEFC
MAX TEMPERATURE	180°F (80°C)
MAX WORKING PRESSURE (PSI)	150
SELF PRIMING	No
SHAFT AND HARDWARE	Stainless Steel
O-RINGS AND MECHANICAL SEALS	Buna-N

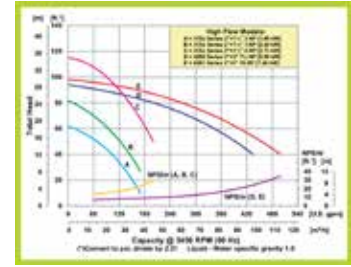

C&M PART #	MFG PART #	HP	VOLTS / PHASE	SUCTION SIZE	DISCHARGE SIZE	FULL LOAD (Amps)	WEIGHT (lbs)
PUMP CURVE A							
105842EJ50PC	3156-95	2	115-230 VAC / 1	2" NPT(F)	1-1/2" NPT(F)	22 / 11	78
105842EK50PF	3150-95	2	230-460 VAC / 3	2" NPT(F)	1-1/2" NPT(F)	6 / 3	84
105842EJ50PF	3157-95	2	230-460 VAC / 3	2" NPT(F)	1-1/2" NPT(F)	6 / 3	71
PUMP CURVE B							
105842NM87PA	315A-95	3	230 VAC / 1	2" NPT(F)	1-1/2" NPT(F)	12	87
105842NM87PF	3151-95	3	230-460 VAC / 3	2" NPT(F)	1-1/2" NPT(F)	8 / 4	137
PUMP CURVE C							
105842XTF9PA	315E-95	5	230 VAC / 1	2" NPT(F)	1-1/2" NPT(F)	16	143
105842XTF9PF	3152-95	5	230-460 VAC / 3	2" NPT(F)	1-1/2" NPT(F)	17 / 9	145
PUMP CURVE D							
105842XUOMPF	4260-95	7-1/2	230-460 VAC / 3	3" NPT(F)	3" NPT(F)	22 / 11	172
PUMP CURVE E							
105842FDN8PF	4261-95	10	230-460 VAC / 3	3" NPT(F)	3" NPT(F)	26 / 13	204
PUMP CURVE F							
105842XTOMPF	4240-95	7-1/2	230-460 VAC / 3	2" NPT(F)	1-1/2" NPT(F)	22 / 11	163
PUMP CURVE G							
105842EUN8PF	4250-95	10	230-460 VAC / 3	3" NPT(F)	3" NPT(F)	26 / 13	208
PUMP CURVE H							
105842EXS2PF	4251-95	15	230-460 VAC / 3	3" NPT(F)	3" NPT(F)	47 / 24	218

AMT® Medium Head Centrifugal Pumps

AMT Medium-Head Centrifugal Pumps are designed for continuous-duty, low pressure OEM, industrial/commercial and general service applications. Use for circulation, chemical processing, dirty water and liquid transfer. Self-cleaning impeller prevents clogging and handles solids up to 1/8" in diameter.

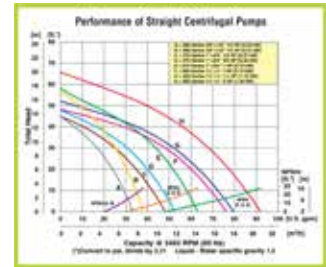

SPECIFICATIONS

SOLIDS HANDLING	Up to 1/8"
CONSTRUCTION	Cast Iron
IMPELLER	Self-Cleaning Stainless Steel
MOTOR	TEFC
MAX TEMPERATURE	180°F (82°C)
MAX WORKING PRESSURE (PSI)	150
SELF-PRIMING	No
SHAFT AND HARDWARE	Stainless Steel
O-RINGS AND MECHANICAL SEALS	Buna-N

C&M PART #	MFG PART #	HP	VOLTS / PHASE	SUCTION SIZE	DISCHARGE SIZE	FULL LOAD AMPS	WEIGHT (lbs)
PUMP CURVE A							
1058330C	368A-95	1/3	115-230 VAC / 1	3/4" NPT(F)	1/2" NPT(F)	7 / 4	34
PUMP CURVE B							
1058330E	368B-95	1/2	115-230 VAC / 1	3/4" NPT(F)	1/2" NPT(F)	9 / 5	35
PUMP CURVE D							
1058330F	370A-95	3/4	115-230 VAC / 1	1" NPT(F)	3/4" NPT(F)	9 / 5	41
PUMP CURVE E							
10583330	370E-95	1	115-230 VAC / 1	1" NPT(F)	3/4" NPT(F)	12 / 6	42
PUMP CURVE G							
1058330G	369A-95	1-1/2	115-230 VAC / 1	1-1/4" NPT(F)	1" NPT(F)	18 / 9	52

TABLE OF CONTENTS

Gas Detection	308	Hand Protection - Waterproof / Cold Weather Gloves	349-350
Confined Space & Fall Protection - Harnesses and Lanyards	309-311	Head Protection - Hard Hats and Safety Helmets	351-353
Confined Space & Fall Protection - Tripods, Hoists and Winches	312-316	Head Protection - Head and Neck Cooling/Warmers	353-354
Safety Blowers & Ventilation	317-319	Hearing Protection - Earmuffs	354
Eye Protection - Face Shields	320	Hearing Protection - Earplugs	355
Eye Protection	321-326	Heat Stress Protection - Cooling Towels	356
Eyewash Stations & Showers	327-331	Heat Stress Kits	356
Eyewash Stations & Showers Accessories	332	Coolers	356-357
First Aid - First Aid Kits	333-334	Heat Stress Protection - Sqwincher	357
Hand Protection	334-341	Respiratory Protection	358-361
Hand Protection - Coated Gloves	342-343	Safety Apparel - Chemical Resistant	362
Hand Protection - Cut-Resistant Gloves	343-347	Safety Apparel - Hi-Vis Apparel	362-371
Hand Protection - Leather & Cotton Gloves	348	Safety Apparel - Raingear	371-372
		Safety Apparel - Waders	372
		Safety Apparel - Work Boots	373



MSA Safety ALTAIR® 4X Multigas Detector



Outfitted with rapid-response MSA XCell® sensors, the ALTAIR 4XR Gas Detector is the toughest four-gas monitor on the market and is backed by a four-year warranty. The XCell sensors provide faster response time, better stability, accuracy, longer service life and cost savings over the life of the instrument. Order GALAXY GX2 automated test system for advanced safety management and effortless operation.

FEATURES & BENEFITS

- Durable, impact-resistant detector
- Ideal for construction, fire service, oil & gas, and utilities
- Dust- and waterproof IP68 rating
- Excellent durability—withstands 25-ft drop onto concrete

INCLUDES

Multigas detector, Tubing, Calibration Cap, North American Charger

C&M PART #	MFG PART #	DESCRIPTION
110125	10178557	ALTAIR 4XR Multigas Detector, Charcoal Case

REPLACEMENT PARTS & ACCESSORIES

C&M PART #	MFG PART #	DESCRIPTION
GALAXY GX2 AUTOMATED TEST SYSTEMS FOR ALTAIR 4/4X MULTIGAS DETECTOR (NORTH AMERICAN CHARGER)		
110137	10127422	Multi-Unit Charger
110139	10128630	One Valve, Charging
110140	10128642	One Valve, Noncharging
110141	10128629	Four Valves, Charging
110142	10128641	Four Valves, Noncharging
ALUMINUM CALIBRATION TESTING GAS CYLINDERS (CH4: 1.45%; O2: 15%; CO: 60 PPM; H2S: 20 PPM)		
110147	10045035	58 L
110148	10048280	34 L



Helpful Tip: Bump Test

Keep your portable gas detection calibrated and compliant with a Bump test before heading out to the site each day.

MSA Safety ALTAIR® 5X Multigas Detector



Use the MSA ALTAIR® 5X Gas Detector with integrated PID sensor to measure up to six gases simultaneously as well as for VOC detection. Driven by advanced MSA XCell® sensor technology, the ALTAIR 5X gas detector delivers faster response time, better stability, accuracy, longer service life and cost savings over the life of the instrument. Order GALAXY GX2 automated test system for advanced safety management and effortless operation.

FEATURES & BENEFITS

- Durable, impact-resistant detector—ideal for construction, fire service, oil & gas, and utilities
- Integral pump with recessed inlet provides improved durability
- High-resolution color display is easy to read and navigate
- Long expected sensor life saves money

INCLUDES

Multigas detector, Tubing, North American Charger, 1-ft long probe and 10-ft sampling line

CERTIFICATIONS

- UL and CSA

C&M PART #	MFG PART #	DESCRIPTION
110126	10116928	MSA ALTAIR 5X Multigas Detector with Color Display

REPLACEMENT PARTS & ACCESSORIES

C&M PART #	MFG PART #	DESCRIPTION
GALAXY GX2 AUTOMATED TEST SYSTEMS FOR ALTAIR 5/5X MULTIGAS DETECTOR (NORTH AMERICAN CHARGER)		
110138	10127427	Multi-Unit Charger
110143	10128626	One Valve, Charging
110144	10128628	One Valve, Noncharging
110145	10128625	Four Valves, Charging
110146	10128627	Four Valves, Noncharging
ALUMINUM CALIBRATION TESTING GAS CYLINDERS (CH4: 1.45%; O2: 15%; CO: 60 PPM; H2S: 20 PPM)		
110147	10045035	58 L
110148	10048280	34 L

MSA V-FORM™ Safety Harnesses

The V-FORM Harness features a patent pending RaceFORM™ buckle which eliminates bulky chest straps for a close and comfortable fit. The athletic cut of the harness contours to the body improving upper torso movement on the job, while its downward adjusting design allows you to quickly adjust your harness for a fit that lasts throughout the day.



CERTIFICATIONS

- ANSI Z359.11 and CSA Z259.10

C&M PART #	MFG PART #	SIZE	WORKLOAD LIMIT (lbs)	LIFT CAPACITY (lbs)	WEIGHT (lbs)	D-RING CONFIGURATION
110167	10206058	Standard	400	130 to 310	2.98	Back
110168	10206063	X-Large	400	130 to 310	3.75	Back and Hips

MSA V-SERIES Standard Adjustable Energy Absorbing Lanyards



The V-SERIES shock absorbing lanyards are designed to dissipate force in a fall. These lightweight safety lanyards not only limit force on the body in a fall, but also on the anchor location. The shock absorbing pouch includes a clear, durable protective cover on the labels to increase service life and allow for easy inspection.

CERTIFICATIONS

- ANSI Z359.13-2013 and CSA Z259.11-17

C&M PART #	MFG PART #	SIZE	WORKLOAD LIMIT (lbs)	LIFT CAPACITY (lbs)	WEIGHT (lbs)	LEG CONFIGURATION
110165	10191757	Standard	310	130 to 310	3.53	Single
110166	10191758	Standard	310	130 to 310	6.17	Double

MSA Tool Tethers with Carabiner and Adjustable Loop

MSA Tool Tethers are color coded to make weight capacity identifiable at a distance and feature durable stainless-steel screw-gate carabiners to ensure secure and reliable attachments.



C&M PART #	MFG PART #	WORKLOAD LIMIT (lbs)	CABLE LENGTH	COLOR
110156	10207284	5	47.5"	Green/Black Stripe
110157	10207285	10	47.5"	Gray/Black Stripe
110158	10207286	15	47.5"	Black/Green Stripe

MSA V-FIT™ Safety Harnesses

The V-FIT Harness features a patent pending RaceFLEX™ buckle which eliminates bulky chest straps for a close and comfortable fit. Shoulder pads responds to your movement to conform to your body eliminating pressure points while providing comfort. The athletic cut of the harness contours to the body improving upper torso movement on the job, while its downward adjusting design allows you to quickly adjust your harness for a fit that lasts throughout the day. A dedicated attachment point for personal fall limiters provides extra safety measures.



CERTIFICATIONS

- ANSI Z359.11 and CSA Z259.10

C&M PART #	MFG PART #	SIZE	WORKLOAD LIMIT (lbs)	LIFT CAPACITY (lbs)	WEIGHT (lbs)	D-RING CONFIGURATION
110159	10194630	Standard	400	130 to 310	3.53	Back
110160	10194874	X-Large	400	130 to 310	4.19	Back and Hips

MSA V-FORM™+ Safety Harnesses

The V-FORM+ Harness features a patent pending racing-style buckle which eliminates bulky chest straps for a close and comfortable fit. Shoulder pads responds to your movement to conform to your body eliminating pressure points while providing comfort. The athletic cut of the harness contours to the body improving upper torso movement on the job, while its downward adjusting design allows you to quickly adjust your harness for a fit that lasts throughout the day. A dedicated attachment point for personal fall limiters provides extra safety measures.



CERTIFICATIONS

- ANSI Z359.11 and CSA Z259.10

C&M PART #	MFG PART #	SIZE	WORKLOAD LIMIT (lbs)	LIFT CAPACITY (lbs)	WEIGHT (lbs)	D-RING CONFIGURATION
110163	10206086	X-Large	400	130 to 310	3.51	Back
110164	10206090	X-Large	400	130 to 310	4.19	Back and Hips



Honeywell® Miller® Manyard™ Lanyard with Locking Snaps



The Manyard shock-absorbing lanyard with locking snaps features a special woven inner core that expands during a fall to reduce fall arrest forces. The heavy-duty tubular outer jacket serves as a back-up web lanyard. A warning flag provides a visual sign if the lanyard was involved in a serious fall so it can be removed from service.

CERTIFICATIONS

- OSHA 1926.502, 1910.66; ANSI A10.32 and CSA Z259.11

C&M PART #	MFG PART #	LENGTH (ft)	WORKLOAD LIMIT (lbs)
101290	216WLS-Z7/6FTYL	6	310

Honeywell® Miller® Manyard™ II Lanyard with Rebar Hook



The Manyard II shock-absorbing lanyard with rebar and snap hooks reduce fall arrest forces ensuring worker safety. The lanyard stretches to 6 ft for greater maneuverability while contracting to 4 ft to eliminate it as a tripping hazard. A unique red core wear indicator shows through the bright green lanyard to tell if the lanyard should be removed from service.

CERTIFICATIONS

- OSHA 1926.502, 1910.66 and ANSI Z359.13

C&M PART #	MFG PART #	LENGTH	WORKLOAD LIMIT (lbs)	FALL ARREST FORCE (lbs)	WEIGHT (lbs)
101291	219M-Z7/6FTGN	48"	310	900	2.79

Honeywell® Miller® Cross Arm Strap

The Cross Arm Strap wraps around approved I-beams or other structures for a secure attachment point for lanyards and self-retracting lifelines. Strap is constructed of 2" wide polyester webbing and steel D-rings for durability.



C&M PART #	MFG PART #	LENGTH (ft)	WORKLOAD LIMIT (lbs)	LIFT CAPACITY (lbs)	WEIGHT (lbs)
101308	8183/6FTGN	6	400	130 to 310	1.3

Honeywell® Miller® Revolution™ Harness with DualTech™ Webbing

The Revolution Harness with DualTech webbing features a soft, textured inside and a durable, chemical-resistant polyester outer material. This harness combines safety and functionality to meet key user-identified needs; comfort, fit, ease-of-use, style, durability, compliance, flexibility and convenience. Tested to 7,000 lbs tensile strength (40% stronger than ANSI requirements), it provides greater safety and longer service life.



CERTIFICATIONS

- Meets or exceeds all OSHA, ANSI and CSA specifications

C&M PART #	MFG PART #	SIZE	WORKLOAD LIMIT (lbs)	D-RING CONFIGURATION
101283	RDT-QC/UBK	Universal; Large/X-Large	400	Back

HOW TO ORDER



ONLINE
supply.coreandmain.com



TELEPHONE
1-888-885-2673



EMAIL
support.supply@coreandmain.com

HOURS OF OPERATION: M-F; 6 A.M. to 7 P.M. CST

Honeywell® Miller® Revolution™ Harness with Kevlar®/Nomex® Webbing

The Revolution Harness with Kevlar/Nomex webbing meets key user-identified needs; comfort, fit, ease-of-use, style, durability, compliance, flexibility and convenience. Rugged, black Kevlar outside and gray Nomex inside provide superior comfort and durability for harsh working environments. Removable belt and convenient quick-connect buckle legs make the harness easy to use.



CERTIFICATIONS

- Meets or exceeds all OSHA, ANSI and CSA specifications

C&M PART #	MFG PART #	SIZE	WORKLOAD LIMIT (lbs)	D-RING CONFIGURATION
101284	RKN-QC/UBK	Universal; Large/X-Large	400	Back



Helpful Tip: Fall Protection and Confined Space Safety

Confined spaces are some of the most dangerous places for workers to operate. These tight spaces are often dark, cramped, and contain hazardous chemicals. To protect workers from the hazards of confined spaces, employers must follow established safety procedures. This includes identifying and evaluating all hazards in the confined space before any work begins, developing a plan to control or eliminate those hazards, and providing workers with the proper training and equipment.

We offer a variety of products to help increase the safety of workers working in confined spaces. Some of the most important products include:

Portable Gas Detection: Gas detection is used to detect various types of hazardous gas prior to entering a confined space.

Ventilation equipment: Ventilation equipment is used to remove hazardous atmospheres from confined spaces and supply fresh air to workers.

Respiratory protection equipment: Respiratory protection equipment is used to protect workers from breathing hazardous atmospheres.

Fall protection equipment: Fall protection equipment is used to prevent workers from falling when working in confined spaces.

PPE products: PPE products range from Apparel (Hi-Vis & Chem Resistant), Eye, Face, Hand, Hearing, Head, & Foot protection to keep works safety for all environments.

Traffic Safety equipment: Cones, Barricades and Rollup Road Signs is used protect open entry points like manhole openings by warning oncoming traffic or pedestrians.

Honeywell® Miller® Aircore™ Harness with Front D-Ring

The Aircore Harnesses are designed with breathable, open-core padding technology to keep a worker drier and cooler. Strategically placed open-core padding maximizes airflow while reducing heat and moisture build-up; takes up to 16% less surface area than other padding used on the market. One-hand adjustment shoulder cam buckles, stand-up back D-ring, quick-connect chest buckle and pull-free lanyard rings make it easy to use. All harnesses come with a front D-ring; hardwares are constructed of steel for durability.



CERTIFICATIONS

- Harness meets OSHA 1926.502, ANSI A10.32, ANSI Z359.11-14 and CSA Z259.10-12 requirements

C&M PART #	MFG PART #	SIZE	WORKLOAD LIMIT (lbs)	FRONT D-RING/ SIDE D-RING	LEG STRAP	WEIGHT (lbs)
101276	ACF-QCDUG	Large/ X-Large	400	Yes/Yes	Quick-Connect	4.8
101277	ACF-QCUG	Large/ X-Large	400	Yes/No	Quick-Connect	4.1
101278	ACF-TBDUG	Large/ X-Large	400	Yes/Yes	Tongue	4.8
101279	ACF-TBUG	Large/ X-Large	400	Yes/No	Tongue	4.1

Honeywell® Miller® Aircore™ Harness with Steel Hardware

The Aircore Harnesses are designed with breathable, open-core padding technology to keep a worker drier and cooler. Strategically placed open-core padding maximizes airflow while reducing heat and moisture build-up; takes up to 16% less surface area than other padding used on the market. One-hand adjustment shoulder cam buckles, stand-up back D-ring, quick-connect chest buckle and pull-free lanyard rings make it easy to use. All hardwares are constructed of steel for durability.



CERTIFICATIONS

- Harness meets OSHA 1926.502, ANSI A10.32, ANSI Z359.11-14 and CSA Z259.10-12 requirements

C&M PART #	MFG PART #	SIZE	WORKLOAD LIMIT (lbs)	SIDE D-RING/ SHOULDER D-RING	WEIGHT (lbs)
101280	AC-QC/UGN	Large/ X-Large	400	No/No	4.0
101281	AC-QC-BDP/UGN	Large/ X-Large	400	Yes/No	6.1



MSA Workman Confined Space Entry (CSE) Kit



The MSA Workman CSE Tripod Kit provides simple ordering with all the necessary components for a complete safety system. Use the kit to help protect workers in tight spaces. The entire Workman CSE kit takes only minutes to set up; no tools are needed. Kits are ideal for applications in tanks, manholes and other vertical entry work practices.

INCLUDES

8-ft high tripod, rescuer with 50 ft long stainless steel (SS) cable, Winch with 65 ft long SS cable, Stainless Steel Cable, two pulleys, two carabiners and carrying bag

CERTIFICATIONS

- ANSI Z359.14, CSA certified and meets OSHA standards

C&M PART #	MFG PART #	WORKLOAD LIMIT (lbs)	LIFT CAPACITY (lbs)	WEIGHT (lbs)	CONFIGURATION
110149	10163033	Personnel: 400 Materials: 620	Personnel: 400 Materials: 620	45	iD (RFID)

REPLACEMENT PARTS & ACCESSORIES

C&M PART #	MFG PART #	DESCRIPTION
110150	10063431	Suspension Trauma Safety Step with Carabiner
110151	VSOHW-011-NF-A	V-SHOCK® Personal Fall Limiter, Single Leg, 36CL Steel Snaphook
110152	VSOHW-011-NA-A	V-SHOCK Personal Fall Limiter, Single Leg, AL36CL Aluminum Snaphook
110153	VSOHW-011-NJ-O-TB	V-SHOCK Personal Fall Limiter, Single Leg, Tie-Back, FP5K Snaphook
110154	VSOHW-012-QF-A	V-SHOCK Personal Fall Limiter, Twin Leg, 36CL Steel Snaphooks
110155	VSOHW-012-QA-A	V-SHOCK Personal Fall Limiter, Twin Leg, AL36CL Aluminum Snaphooks
110156	10207284	Tool Tether Carabiner w/ Adjustable Loop, 5 lbs, 47.5"L, Green/Black Stripe
110157	10207285	Tool Tether Carabiner w/ Adjustable Loop, 10 lbs, 47.5"L, Gray/Black Stripe
110158	10207286	Tool Tether Carabiner w/ Adjustable Loop, 15 lbs, 47.5", Black/Green Stripe
110159	10194630	V-FIT™ Harness, Standard, Back D-Ring
110160	10194874	V-FIT Harness, X-Large, Back & Hip D-Rings
110161	10147301	Workman Winch, 65 ft Long Stainless Steel Cable
110162	63306-00A	V-TEC™ Standard Cable Self Retracting Lanyard, 20 ft Stainless Steel Cable
110163	10206086	V-FORM+™ Harness, X-Large, Back D-Ring, Tongue Buckle Leg Straps
110164	10206090	V-FORM+ Harness, X-Large, Back & Hip D-Rings, Tongue Buckle Leg Straps
110165	10191757	V-SERIES™ Standard Single Leg Adjustable Energy Absorbing Lanyard
110166	10191758	V-SERIES Standard Twin Leg Adjustable Energy Absorbing Lanyard
110167	10206058	V-FORM™ Harness, Standard, Back D-Ring, Tongue Buckle Leg Straps
110168	10206063	V-FORM Harness, X-Large, Back & Hip D-Rings

MSA V-SHOCK® Personal Fall Limiters (PFL)

The V-SHOCK nonleading edge web PFLs ensure safety from fall while providing comfort. These lightweight self-retracting devices extend 6 ft long and offer high-strength and impact resistance.



CERTIFICATIONS

- ANSI Z359.14-21, OSHA 29 CFR Part 1910.140 & 1926.502 and CSA Z259.2.2-17

C&M PART #	MFG PART #	CONFIGURATION	WEIGHT CAPACITY (lbs)	HARDWARE MATERIAL	SNAPHOOK TYPE
110151	VSOHW-011-NF-A	Single Leg	310	Steel	36CL
110152	VSOHW-011-NA-A	Single Leg	310	Aluminum	AL36CL
110153	VSOHW-011-NJ-O-TB	Single Leg	310	Steel	FP5K
110154	VSOHW-012-QF-A	Twin Leg	310	Steel	36CL
110155	VSOHW-012-QA-A	Twin Leg	310	Aluminum	AL36CL

MSA V-TEC™ Self-Retracting Lifeline

With premium stainless-steel components and innovative engineering, the V-TEC Self Retracting Lifeline incorporates a precision-made spring radial energy absorber that requires zero calibration or adjustment. The retraction dampening feature controls cable retraction speeds preventing pre-mature and accidental load indicator deployment.



CERTIFICATIONS

- ANSI/ASSE Z359.14

C&M PART #	MFG PART #	COLOR	WORKLOAD LIMIT (lbs)	LIFT CAPACITY (lbs)	CABLE LENGTH (ft)
110162	63306-00A	Clear	400	130 to 310	20

Honeywell® Miller® Fall Protection

REPLACEMENT PARTS & ACCESSORIES

C&M PART #	MFG PART #	DESCRIPTION
101284	RDT-QC/UBK	Revolution™ Harness with DualTech Webbing, Large/X-Large
101284	RKN-QC/UBK	Revolution Harness with Kevlar/Nomed Webbing, Large/X-Large
101289	216M-Z7/6FTGN	Manyard™ II Lanyard with Locking Snaps, Green, ANSI Z7
101290	216WLS-Z7/6FTYL	Manyard Lanyard with Locking Snaps, Yellow, ANSI Z7
101291	219M-Z7/6FTGN	Manyard II Lanyard with Rebar Hook/Locking Snap, Green, ANSI Z7
101308	8183/6FTGN	Cross Arm Strap, Green
101313	FL11-3-Z7/11FT	MiniLite Fall Limiter w/ Carabiner & Snap, 11 ft L Cable, ANSI Z7
101314	MFL-11-Z7/6FT	TurboLite™ Fall Limiter w/ Aluminum Carabiner & Snap, 6 ft L Cable, ANSI Z7
101315	MFL-12-Z7/6FT	TurboLite Fall Limiter w/ Aluminum Carabiner & Rebar Hook, 6 ft L Cable, ANSI Z7
101316	MFL-1-Z7/6FT	TurboLite Fall Limiter w/ Steel Carabiner & Snap, 6 ft L Cable, ANSI Z7
101317	MFL-1-Z7/9FT	TurboLite Fall Limiter w/ Steel Carabiner & Snap, 9 ft L Cable, ANSI Z7
101318	MFL-2-Z7/6FT	TurboLite Fall Limiter w/ Steel Carabiner & Rebar, 6 ft L Cable, ANSI Z7
101319	MFLC-12-Z7/6FT	G2 Twin Turbo™ System w/ Two MFL-12-Z7/6FT Fall Limiters, ANSI Z7
101320	MFLC-12-Z7/9FT	G2 Twin Turbo System w/ Two MFL-12-Z7/9FT Fall Limiters, ANSI Z7
101321	MFLC-4-Z7/6FT	G2 Twin Turbo System w/ Two MFL-4-Z7/6FT Fall Limiters, ANSI Z7
101322	MFLEC2-12/6FT	Turbo Edge 2 Personal Fall Limiter, Aluminum Rebar Hook, 6 ft L Cable
101323	MFLEC2-12/9FT	Turbo Edge 2 Personal Fall Limiter, Aluminum Rebar Hook, 9 ft L Cable
101324	MFLEC2-4/6FT	Turbo Edge 2 Personal Fall Limiter, Steel Rebar Hook, 6 ft L Cable
101325	MP20G-Z7/20FT	Falcon™ Self-Retracting Lifeline, 20 ft L Cable, ANSI Z7
101326	MP30G-Z7/30FT	Falcon Self-Retracting Lifeline, 30 ft L Cable, ANSI Z7
101327	MP50G-Z7/50FT	Falcon Self-Retracting Lifeline, 50 ft L Cable, ANSI Z7
101333	MR50SB-Z7/50FT	MightEvac® SRL, 3/16" x 50 ft with Stainless Steel Mounting Bracket, ANSI Z7
101334	PFL-4-Z7/9FT	Scorpion PFL with SS Swivel & Carabiner, 9 ft L Cable, ANSI Z7
101335	RL20SS-Z7/20FT	Self-Retracting Lifeline, 20 ft L Stainless Steel, ANSI Z7
101336	RLS30S-Z7/30FT	Self-Retracting Lifeline, 30 ft L Stainless Steel, ANSI Z7



This lightweight, versatile Tripod is designed for typical confined space and rescue systems. Constructed of high-strength alloy aluminum, it helps keep workers safe while entering, escaping and working within a confined space.

CERTIFICATIONS

- ANSI Z359.1, OSHA 1926.502, CE0333 – EN795 class B (Model 51 only)

C&M PART #	MFG PART #	DESCRIPTION
101337	51/7FT	Fall Protection Tripod, 7 ft
101338	51X/9FT	Fall Protection Tripod, 9 ft

MSA Workman Winch

The new Workman Winch is rugged, versatile and economical for lifting, lowering and positioning personnel and materials within confined space applications. Designed for maximum 140 kg workload for personnel and 225 kg for materials, the winch is built with tough thermoplastic housing and stainless steel cable to ensure high performance within the harshest environments. Winch offers integral, ergonomic carrying grip and unique, foldable handle for simple storage. Patent-pending bracket design allows for easy, rapid assembly.



CERTIFICATIONS

- ANSI/ASSE Z359.1

C&M PART #	MFG PART #	COLOR	WORKLOAD LIMIT (lbs)	LIFT CAPACITY (lbs)	CABLE LENGTH (ft)
110161	10147301	Yellow	400 to 620	400 to 620	65

MSA Suspension Trauma Safety Step

Use the lightweight Suspension Trauma Safety Step as a ladder to reduce the potential for suspension trauma following a fall in a full body harness for fall arrest. Simply place the feet in the loops of the safety step and “pump” the legs while suspended in the harness to reduce the potential for suspension trauma.



C&M PART #	MFG PART #	COLOR	WORKLOAD LIMIT (lbs)	LIFT CAPACITY (lbs)	CABLE LENGTH (ft)
110150	10063431	Black	400	400	6

Honeywell® Miller® Falcon™ Self-Retracting Lifelines (SRL)

The Falcon SRL is the lightest, most rugged line of composite retractable SRLs on the market. Made of extremely durable, impact-resistant nylon housing with galvanized steel cable, pound for pound these SRLs are the strongest and most durable retractable lifeline available. Dual swivels (unit top and snap hook) provide support and leverage when attaching to anchorage connector for easy installation. Workload limit of 310 lbs.



CERTIFICATIONS

- Meets all applicable OSHA 1926.502, ANSI A10.32, ANSI Z359.14 Class B and CSA Z259.2.2 requirements

C&M PART #	MFG PART #	DESCRIPTION
101325	MP20G-Z7/20FT	Falcon Self-Retracting Lifeline, ANSI Z7, 20 ft L Cable
101326	MP30G-Z7/30FT	Falcon Self-Retracting Lifeline, ANSI Z7, 30 ft L Cable
101327	MP50G-Z7/50FT	Falcon Self-Retracting Lifeline, ANSI Z7, 50 ft L Cable

Honeywell® Miller® Twin Turbo™ Fall Protection System with G2 Connector

The lightweight patent-pending G2 connector allows users to benefit from 100% connection while working at heights utilizing two TurboLite™ personal fall limiters (PFLs). The PFLs swivel independently to prevent webbing from twisting and binding in the unit. Corrosion-resistant aluminum connector and high-impact nylon result in a longer product life.



CERTIFICATIONS

- Meets all applicable OSHA, ANSI, and CSA requirements

C&M PART #	MFG PART #	DESCRIPTION
101319	MFLC-12-Z7/6FT	System w/ Two MFL-12-Z7/6FT PFLs, Aluminum Locking Rebar Hooks, 6 ft L Cable
101320	MFLC-12-Z7/9FT	System w/ Two MFL-12-Z7/9FT PFLs, Aluminum Locking Rebar Hooks, 9 ft L Cable
101321	MFLC-4-Z7/6FT	System w/ Two MFL-4-Z7/6FT PFLs, Steel Locking Rebar Hooks, 6 ft L Cable

Honeywell® Miller® Complete Confined Space Entry (CSE) & Rescue System



Get the complete CSE & Rescue system featuring MightEvac® Self-Retracting Lifeline (SRL). It combines the superior performance and reliability of the MightyLite™ SRL with a quick-activating retrieval mechanism for emergency evacuation.

CERTIFICATIONS

- Meets OSHA 1926.502, 1910.66, ANSI A10.32

C&M PART #	MFG PART #	DESCRIPTION
101329	MR50GCM-Z7/50FT	Complete System with 50 ft SRL, 7 ft Tripod and 65 ft Hoist
101330	MR50GC-Z7/50FT	Complete System with 50 ft SRL and 7 ft Tripod
101331	MR50GXM-Z7/50FT	Complete System with 50 ft SRL, 9 ft Tripod and 65 ft Hoist
101332	MR50GX-Z7/50FT	Complete System with 50 ft SRL and 9 ft Tripod

REPLACEMENT PARTS & ACCESSORIES

C&M PART #	MFG PART #	DESCRIPTION
101284	RDT-QC/UBK	Revolution™ Harness with DualTech Webbing, Large/X-Large
101284	RKN-QC/UBK	Revolution Harness with Kevlar/Nomed Webbing, Large/X-Large
101289	216M-Z7/6FTGN	Manyard™ II Lanyard with Locking Snaps, Green, ANSI Z7
101290	216WLS-Z7/6FTYL	Manyard Lanyard with Locking Snaps, Yellow, ANSI Z7
101291	219M-Z7/6FTGN	Manyard II Lanyard with Rebar Hook/Locking Snap, Green, ANSI Z7
101308	8183/6FTGN	Cross Arm Strap, Green
101313	FL11-3-Z7/11FT	MiniLite Fall Limiter w/ Carabiner & Snap, 11 ft L Cable, ANSI Z7
101314	MFL-11-Z7/6FT	TurboLite™ Fall Limiter w/ Aluminum Carabiner & Snap, 6 ft L Cable, ANSI Z7
101315	MFL-12-Z7/6FT	TurboLite Fall Limiter w/ Aluminum Carabiner & Rebar Hook, 6 ft L Cable, ANSI Z7
101316	MFL-1-Z7/6FT	TurboLite Fall Limiter w/ Steel Carabiner & Snap, 6 ft L Cable, ANSI Z7
101317	MFL-1-Z7/9FT	TurboLite Fall Limiter w/ Steel Carabiner & Snap, 9 ft L Cable, ANSI Z7
101318	MFL-2-Z7/6FT	TurboLite Fall Limiter w/ Steel Carabiner & Rebar, 6 ft L Cable, ANSI Z7
101319	MFLC-12-Z7/6FT	G2 Twin Turbo™ System w/ Two MFL-12-Z7/6FT Fall Limiters, ANSI Z7
101320	MFLC-12-Z7/9FT	G2 Twin Turbo System w/ Two MFL-12-Z7/9FT Fall Limiters, ANSI Z7
101321	MFLC-4-Z7/6FT	G2 Twin Turbo System w/ Two MFL-4-Z7/6FT Fall Limiters, ANSI Z7
101322	MFLEC2-12/6FT	Turbo Edge 2 Personal Fall Limiter, Aluminum Rebar Hook, 6 ft L Cable
101323	MFLEC2-12/9FT	Turbo Edge 2 Personal Fall Limiter, Aluminum Rebar Hook, 9 ft L Cable
101324	MFLEC2-4/6FT	Turbo Edge 2 Personal Fall Limiter, Steel Rebar Hook, 6 ft L Cable
101325	MP20G-Z7/20FT	Falcon™ Self-Retracting Lifeline, 20 ft L Cable, ANSI Z7
101326	MP30G-Z7/30FT	Falcon Self-Retracting Lifeline, 30 ft L Cable, ANSI Z7
101327	MP50G-Z7/50FT	Falcon Self-Retracting Lifeline, 50 ft L Cable, ANSI Z7
101333	MR50SB-Z7/50FT	MightEvac® SRL, 3/16" x 50 ft with Stainless Steel Mounting Bracket, ANSI Z7
101334	PFL-4-Z7/9FT	Scorpion PFL with SS Swivel & Carabiner, 9 ft L Cable, ANSI Z7
101335	RL20SS-Z7/20FT	Self-Retracting Lifeline, 20 ft L Stainless Steel, ANSI Z7
101336	RLS30S-Z7/30FT	Self-Retracting Lifeline, 30 ft L Stainless Steel, ANSI Z7

Honeywell® Miller® MightyLite™ Self-Retracting Lifelines (SRLs)

The MightyLite™ SRLs are up to 30% lighter than competitive models in their class. Durable and dependable, they are constructed of corrosion-resistant stainless steel and aluminum housing. SRL comes with stainless steel cable with tagline and carabiner.



INCLUDES

Carabiner and tagline

CERTIFICATIONS

- Meets OSHA 1926.502, 1910.66, ANSI A10.32, ANSI Z359.14-2012 Class B and CSA Z259.2.2-98 Type 2 requirements

C&M PART #	MFG PART #	CABLE LENGTH (ft)	WORKLOAD CAPACITY (lbs)	WEIGHT (lbs)
101335	RL20SS-Z7/20FT	20	310	11.75
101336	RLS30S-Z7/30FT	30	310	13.80

Honeywell® Miller® MightEvac® Self-Retracting Lifelines (SRL) with Hoist

The MightEvac combines the superior performance and reliability of the best-selling MightyLite™ Self-Retracting Lifeline with a quick-activating retrieval mechanism for emergency evacuation.



CERTIFICATIONS

- Meets OSHA 1926.502, 1910.66, ANSI A10.32, ANSI Z359-2007, CSA Z259.2.2 requirements

C&M PART #	MFG PART #	CABLE TYPE	CABLE LENGTH (ft)	WEIGHT (lbs)
101328	MR50GB-Z7/50FT	Galvanized	50	44
101333	MR50SB-Z7/50FT	Stainless Steel	50	39

Honeywell® Miller® ManHandler® Hoist with Tripod

The ManHandler Hoist is the perfect solution for a range of applications including confined space entry, rescue, positioning and personnel/material handling. Smooth, controlled winding action plus effortless lifting and lowering for easy worker positioning.



A secondary fall arrest system is recommended for fall protection.

CERTIFICATIONS

- Meets OSHA 1910.146 and ANSI Z117.1 requirements; ANSI Z359-2007 compliant for connectors which meet the 3600lb gate requirements, ANSI Z117.1, and OSHA 1910.146 requirements

C&M PART #	MFG PART #	CABLE LENGTH (ft)	WORKING CAPACITY (lbs)	WEIGHT (lbs)	TRIPOD HEIGHT (ft)
101339	8442GC-Z7/65FT	65	350	40	7

Honeywell® Miller® Scorpion™ Personal Fall Limiter

The lightweight, compact Scorpion Personal Fall Limiter provides workers an affordable alternative to shock-absorbing lanyards. In a head-to-head comparison with shock-absorbing lanyards, the Scorpion web retractable requires less fall clearance, offers greater mobility and prevents tripping hazards.



CERTIFICATIONS

- Meets OSHA 1926.502, OSHA 1910.66, ANSI A10.32-2012, ANSI Z359.14-2012 Class A and B, and CSA Z259.2.2 Type 1 requirements

C&M PART #	MFG PART #	UNIT CONNECTOR	LANYARD END CONNECTOR	CABLE LENGTH (ft)	WORKING CAPACITY (lbs)	WEIGHT (lbs)
101334	PFL-4-Z7/9FT	Steel Carabiner & Swivel Shackle	Steel Locking Snaphook	9	310	3.7

Honeywell® Miller® Turbo™ Edge 2 Personal Fall Limiters

The Turbo Edge 2 Personal Fall Limiter is designed for use in sharp edge applications with radius \geq 0.005" (0.13 mm). It is equipped with an easy-to-install, shock-absorbing connector system and features twin-leg design with galvanized cable lifeline.



CERTIFICATIONS

- Meets ANSI Z359.14 Class B and Leading Edge requirements

C&M PART #	MFG PART #	HOOK TYPE	CABLE LENGTH (ft)	WEIGHT (lbs)
101322	MFLEC2-12/6FT	Aluminum Rebar Hook	6	8
101323	MFLEC2-12/9FT	Aluminum Rebar Hook	9	8.3
101324	MFLEC2-4/6FT	Steel Rebar Hook	6	8



Honeywell® Miller® TurboLite™ Personal Fall Limiters

Cost-effective, compact and lightweight TurboLite Personal Fall Limiters attach directly to harness back D-ring for greater mobility and versatility. Engineered webbing provides greater abrasion resistance and longer service life. Built-in swivel prevents lifeline from twisting for added safety.



CERTIFICATIONS

- Meets OSHA 1926.502, 1910.66, ANSI A10.32-2012, ANSI Z359; 14-2012 Class A and B, CSA Z259.2.2 Type 1 requirements

C&M PART #	MFG PART #	UNIT CONNECTOR	LANYARD END CONNECTOR	CABLE LENGTH (ft)	WEIGHT (lbs)
101314	MFL-11-Z7/6FT	Aluminum Carabiner	Aluminum Locking Snaphook	6	2.8
101315	MFL-12-Z7/6FT	Aluminum Carabiner	Aluminum Locking Rebar Hook	6	3.2
101316	MFL-1-Z7/6FT	Steel Carabiner	Steel Locking Snaphook	6	1.7
101317	MFL-1-Z7/9FT	Steel Carabiner	Steel Locking Snaphook	9	1.6
101318	MFL-2-Z7/6FT	Steel Carabiner	Steel Locking Rebar Hook	6	2.1

Honeywell® Miller® MiniLite™ Fall Limiter

The MiniLite Fall Limiter is a self-retracting web lanyard with a quick activating braking system that limits a free fall to inches. In contrast to shock-absorbing lanyards, the fall limiter eliminates the need for extended fall distance clearance. This minimizes the risk of injuries and makes rescue easier.



CERTIFICATIONS

- Meets OSHA, ANSI, Z259.2.2 Type 2 and requirements for global compliance

C&M PART #	MFG PART #	UNIT CONNECTOR	LANYARD END CONNECTOR	WORKING CAPACITY (lbs)	CABLE LENGTH (ft)	WEIGHT (lbs)
101313	FL11-3-Z7/11FT	Steel Carabiner & Swivel Shackle	Steel Locking Snaphook	310	11	2.5

NEED HELP FINDING AN ITEM?



Core & Main has access to thousands of products from hundreds of suppliers.

Check out our full assortment of products and suppliers online at

supply.coreandmain.com

or speak with one of our customer service representatives at

1-888-885-2673.

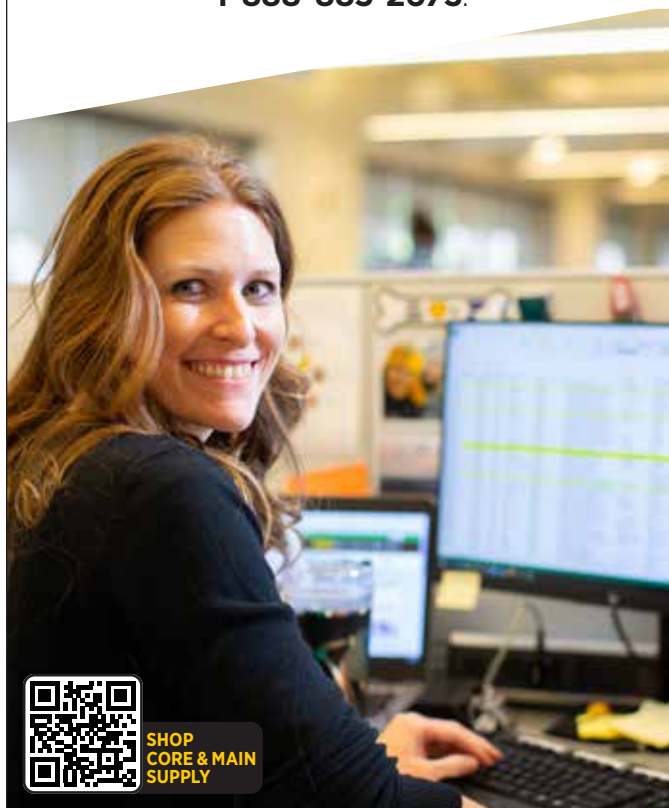

SHOP CORE & MAIN SUPPLY

Allegro Industrial 8" Steel Blowers with Duct Hose

Use these Industrial Steel Blowers to provide ventilation, air circulation and air purification in various industrial settings while ensuring safety standards are met. These blowers are designed to move large volumes of air to maintain air quality, control temperature, and prevent the buildup of hazardous gases, fumes or dust. Retractable, noncollapsible ducts are made of single-ply, PVC-coated, vinyl and polyester.

FEATURES & BENEFITS

- Flange on intake side
- Welded motor mount construction
- Carry handle made of 3-ply rubber belting
- Equipped with four rubber feet
- Ducting is yellow color with black weather-strip and integrated nylon straps



ALLEGRO
INDUSTRIES

SPECIFICATIONS

C&M PART #	105082	105083	105085
PRODUCT TYPE	Axial Blower		
CFM	1150		1275
HORSEPOWER	1/4		1/3
VOLTAGE	12		120
POWER TYPE	Electrical		
AC/DC	DC		AC
WEIGHT (lb)	31	37	32
CORD LENGTH (ft)	15		6

C&M PART #	MFG PART #	DESCRIPTION
105082	9506-25	12 VDC, 1/4 HP, 15-ft L Duct Hose
105083	9506-01	12 VDC, 1/4 HP, 25-ft L Duct Hose
105085	9514	115 VAC, 1/3 HP, 15-ft L Duct Hose

Allegro Industrial Plastic Blowers

These Plastic Blowers provide ventilation, air circulation, and air purification in various industrial settings while ensuring safety standards are met. These blowers are designed to move large volumes of air to maintain air quality, control temperature, and prevent the buildup of hazardous gases, fumes or dust.



ALLEGRO
INDUSTRIES

FEATURES & BENEFITS

- Super quiet
- Polyethylene "safety orange"-colored housing
- Bottom enclosure to protect electrical components
- Carry handle molded into blower
- Built in on/off Switch
- Stackable

Allegro High-Output Steel Blowers

The High-Output Steel Ventilation Safety Blowers are specialized industrial equipment designed for heavy-duty air circulation, ventilation and safety purposes in challenging environments. Cold-rolled steel and powder-coated in "safety orange" color, blowers are built to last. They feature an interchangeable flange for intake or exhaust mounting, integrated carry handles for easy transport and 4 rubber feet.

FEATURES & BENEFITS

- Bolted motor mount construction
- Integrated carrying handles
- Steel/chrome plated grill (105086); steel/zinc plated grill (105093 and 105094)
- Equipped with four rubber feet



ALLEGRO
INDUSTRIES

CERTIFICATIONS

- CSA Standard C22.2 No. 113

SPECIFICATIONS

C&M PART #	105086	105093	105094
SIZE	16"	20"	26"
PRODUCT TYPE	Axial Blower		
CFM	5500	7500	9570
HORSEPOWER	2		
VOLTAGE	115/230		
POWER TYPE	Electrical		
AC/DC	AC		
WEIGHT (lb)	74	83	105
CORD LENGTH (ft)	25		

C&M PART #	MFG PART #	DESCRIPTION
105086	9516	16" Blower
105093	9525-50	20" Blower
105094	9530	26" Blower

SPECIFICATIONS

C&M PART #	105097	105104	105105
SIZE	8"	8"	12"
PRODUCT TYPE	Axial Blower		
CFM	831	865	2180
HORSEPOWER	1/3		1
VOLTAGE	115/230	115	
POWER TYPE	Electrical		
AC/DC	AC		
WEIGHT (lb)	17	16	31
CORD LENGTH (ft)	10	20	

C&M PART #	MFG PART #	DESCRIPTION
105097	9533	8" Blower, 115/230 VAC, 1/3 HP
105104	9539-08	8" Blower, 115 VAC, 1/3 HP
105105	9539-12	12" Blower, 115 VAC, 1 HP

Allegro Centrifugal Manhole Blowers

The “Manhole Blowers” are compact and lightweight for easy use and storage. They are designed for air circulation, ventilation and safety purposes in challenging environments. Two 8” ports offer positive ventilation or fume extraction.

FEATURES & BENEFITS

- Tough “safety orange” polyethylene construction
- One-piece housing with integrated handle
- Steel black powder coated grill
- Equipped with rubber feet



105079



105081

SPECIFICATIONS

C&M PART #	105078	105079	105080	105081
SIZE	8”			
PRODUCT TYPE	Manhole Blower			
CFM	1066	1570	1390	1600
HORSEPOWER	1/3	3/4	5	3.5
VOLTAGE	115		-	
POWER TYPE	Electric		Fuel	Fuel
AC/DC	AC		-	
WEIGHT (lb)	38	45	62	58
CORD LENGTH (ft)	6		-	

C&M PART #	MFG PART #	DESCRIPTION
105078	9504	Standard Electric Blower, 115 VAC, 1/3 HP
105079	9504-50	High-Output Electric Blower, 115 VAC, 3/4 HP
105080	9505	Subaru-Engine Gas-Powered Blower, 5 HP
105081	9505-50	Honda-Engine Gas-Powered Blower, 3.5 HP

Allegro Manhole Blower Systems



105087

105088

105089

105091

The Manhole Blower System include all the most equipment you need for your air circulation and ventilation in a confined space. The systems include your choice of our most popular 8” centrifugal blower, 6 and 15 ft of duct hoses with storage bag and a Manhole Ventilation Pass thru (MVP). The Centrifugal Blower Systems offer lightweight portability with the highest output available.

FEATURES & BENEFITS

- Compact design allows for easy use and storage without sacrificing airflow
- Low-profile elbow fits underneath the lower cross bar of the guardrail
- Manhole cover fits into flat channeled corners for stabilization

INCLUDES

One blower, two duct hoses, one storage bag and one Manhole Ventilation Pass thru

C&M PART #	MFG PART #	DESCRIPTION
105087	9520-04M	Centrifugal Standard Manhole Blower System
105092	9520-50M	Centrifugal High-Output Manhole Blower System
105088	9520-05M	Centrifugal Gas-Powered, Subaru Engine Manhole Blower System
105089	9520-06M	Industrial Steel Axial DC Manhole Blower System
105090	9520-33M	Plastic AC Manhole Blower System
105091	9520-36M	Plastic DC Manhole Blower System

Allegro Axial Plastic Mini-Pak Blowers with Duct Hose

These high-output blowers store ducting inside the blower housing for an all-in-one unit for ease of operation. The compact units are easy to transport and store. Retractable, noncollapsible ducts are made of single-ply, PVC-coated, vinyl and polyester. An additional 12” (30.48 cm) duct (not included) can be attached to the intake side of the blower to draw air



FEATURES & BENEFITS

- The lightest and shortest blower in the industry!
- Super quiet
- Polyethylene housing in “safety orange” color
- Carry handle molded into blower and canister housing
- Ducting - yellow color with black wear strip and integrated nylon attachment strap

SPECIFICATIONS

C&M PART #	105095	105096
SIZE	8”	
PRODUCT TYPE	Axial Blower	
CFM	791	760
HORSEPOWER	1/3	
VOLTAGE	115/230	115/230
POWER TYPE	Electrical	
AC/DC	AC	
WEIGHT (lb)	19	23
CORD LENGTH (ft)	6	

C&M PART #	MFG PART #	DESCRIPTION
105095	9532-15	8” Blower with 15-ft L Duct Hose
105096	9532-25	8” Blower with 25-ft L Duct Hose

Allegro Air Bag Blowers with Duct Hose

Use the ventilation air bag blowers to move air, gases or fumes from one area to another. Ventilation blowers provide efficient air circulation and exchange to create a more comfortable and safer environment. These metal blower systems with built-in duct hose in a heavy-duty polyester bag, provide an all-in-one unit for ease of operation. Zippered ends allow use of the blower without removing it from the bag. Blower features polypropylene seven-blade fan, steel/powder coated housing and grill and carry handle with molded-in two-speed switch.

FEATURES & BENEFITS

- Super quiet
- Unique bag with openings for plug/cord, inlet and outlet
- Easy to carry and store—comes in a durable reinforced polyester bag
- Carry handle with molded-in two-speed switch
- Ducting - yellow with black wear-strip and integrated nylon attachment strap on one end



SPECIFICATIONS

C&M PART #	105100	105101
SIZE	8"	12"
PRODUCT TYPE	AC Air Bag Blower	
CFM	760	1840
HORSEPOWER	1/4	1/2
VOLTAGE	120	
POWER TYPE	Electrical	
AC/DC	AC	
WEIGHT (lb)	25	35
CORD LENGTH (ft)	6	

C&M PART #	MFG PART #	DESCRIPTION
105100	9535-08	8" Air Bag Blower with 15-ft L Duct Hose
105101	9535-12	12" Air Bag Blower with 15-ft L Duct Hose

Allegro Ducting Hoses

The safety ventilation duct hose plays a critical role in maintaining a safe and healthy work environment in industrial settings. It is used to channel and distribute fresh air, remove pollutants, fumes, dust and potentially hazardous substances from a work area.

FEATURES & BENEFITS

- Vinyl and polyester with PVC coating
- Lightweight, retractable, noncollapsible design
- Yellow color with black weather-strip for visibility
- Fastening cuffs at both ends



C&M PART #	MFG PART #	DESCRIPTION
105074	9500-15	8" Dia x 15-ft L
105075	9500-25	8" Dia x 25-ft L
105110	9550-15	12" Dia x 15-ft L
105111	9550-25	12" Dia x 25-ft L
105115	9600-15	16" Dia x 15-ft L
105116	9600-25	16" Dia x 25-ft L

Allegro Plastic Blowers with Canister and Duct Hose



The Plastic Blowers with Canister and Duct Hose provide air circulation, purification and safety in various industrial settings. The quick-connect clipping system allows workers to attach the canister, tools free, to the input side for powerful extraction or output side for ventilation. Retractable, noncollapsible ducts are made of single-ply, PVC-coated, vinyl and polyester.

FEATURES & BENEFITS

- Super quiet
- Polyethylene, "safety orange"-colored housing and canister
- Lightweight and corrosion-, UV- and chemical-resistant
- Conveniently store duct hose in the canister
- Carry handle molded into blower and canister housing

SPECIFICATIONS

MFG PART #	9533-15/25	9536-15/25	9543-15/25	9546-15/25	9553-15/25
PRODUCT TYPE	Axial Blower				
CFM	831	816	1842	1330	3200
HORSEPOWER	1/3	1/4	1	1/4	1
VOLTAGE	115/230	12	115/230	12	115
POWER TYPE	Electrical				
AC/DC	AC	DC	AC	DC	AC
WEIGHT (lb)	25		43		73
CORD LENGTH (ft)	10	6	13	15	20

C&M PART #	MFG PART #	DESCRIPTION
8" BLOWERS		
105098	9533-15	115 VAC, 1/3 HP, 15-ft L Duct Hose
105099	9533-25	115 VAC 1/3 HP, 25-ft Duct Hose
105102	9536-15	12 VDC 1/4 HP, 15-ft Duct Hose
105103	9536-25	12 VDC 1/4 HP, 25-ft Duct Hose
12" BLOWERS		
105106	9543-15	115 VAC, 1 HP, 15-ft L Duct Hose
105107	9543-25	115 VAC, 1 HP, 25-ft L Duct Hose
105108	9546-15	12 VDC, 1/4 HP, 15-ft L Duct Hose
105109	9546-25	12 VDC, 1/4 HP, 25-ft L Duct Hose
16" BLOWERS		
105113	9553-15	115 VAC, 1 HP, 15-ft L Duct Hose
105114	9553-25	115 VAC, 1 HP, 25-ft L Duct Hose

Honeywell Uvex Bionic® Face Shields



Honeywell

The Bionic Face shield is perfect for workers exposed to falling or flying objects, impact, chemical splash and airborne debris. The full shield design is extremely lightweight and balanced for all-day comfort. Highly adjustable, with an easily replaceable visor, the Bionic shield is the face shield workers want to wear.

FEATURES & BENEFITS

- Lightweight, balanced, ergonomic design for extended use
- Comfortably work with most goggles and respirators

CERTIFICATIONS

- Meets ANSI Z87.1-2015 (High Impact) and CSA Z94.3 standards

C&M PART #	MFG PART #	DESCRIPTION
101269	S8500	Uvex Bionic Faceshield, Clear Uncoated Visor
101270	S8510	Uvex Bionic Faceshield, Clear Hardcoat Anti-Fog Visor

REPLACEMENT PARTS & ACCESSORIES

C&M PART #	MFG PART #	DESCRIPTION
101271	S8550	Replacement Visor, Clear Uncoated
101272	S8555	Replacement Visor, Clear Hardcoat/Anti-Fog

Honeywell Uvex Turbosshield™ Face Shields



101285



101286

Honeywell



101287

Uvex Turbosshield Headgear features a cushioning suspension cradle that provides greater contact area with fewer pressure points for all-day wear. Ergonomically designed, large adjustment knobs easily adjust for comfort—even while wearing gloves. The unique curved design visors offer excellent optics, increased field of view and better coverage across the chin area. Order hard hat adapter to use face shield with many popular hard hat brands.

FEATURES & BENEFITS

- Designed for all-day comfort
- Low profile fits easily, even in confined spaces
- Push-button attachment and release system allow visor to come off in seconds
- Patented hard hat adapter design enables visor to slide back
- Dual-hinge adapter design increases clearance by as much as 4"

CERTIFICATIONS

- Meets ANSI Z87.1-2010 and CSA Z94.3 standards

C&M PART #	MFG PART #	DESCRIPTION
101285	S9500	Headgear Only
101286	S9510	Hard Hat Adapter

REPLACEMENT PARTS & ACCESSORIES

C&M PART #	MFG PART #	DESCRIPTION
101287	S9550	Replacement Visor, Clear Uncoated
101288	S9555	Replacement Visor, Clear Hardcoat/Anti-Fog
100248	LCD100	100 Count Lens Cleaning Wipes

SAVE TIME

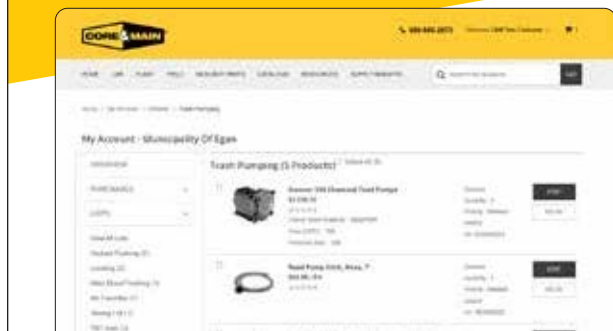

Create quick lists of your favorite products. Organize items in job specific lists to streamline your ordering. Register for an account today at supply.coreandmain.com.

Honeywell Uvex Futura™ Goggles

The Uvex Futura Goggles feature a wraparound design providing an excellent panoramic vision. High-performance Uvextreme® anti-fog coating minimizes fogging even in extreme environments.



Honeywell

FEATURES & BENEFITS

- Fits over most prescription eyewear
- Wraparound style with frosted brow-guard reduces overhead glare
- Offers protection against dust, mist, impact and chemical splash
- Economical lens replacement system

CERTIFICATIONS

- Meets the ANSI Z87.1-2010 standard and CSA Z94.3 standard

C&M PART #	MFG PART #	DESCRIPTION
101311	S345C	Clear Frame, Clear Uvextreme Anti-Fog Lens

REPLACEMENT PARTS & ACCESSORIES

C&M PART #	MFG PART #	DESCRIPTION
100248	LCD100	100 Count Lens Cleaning Wipes

Honeywell Uvex Stealth® Goggles

The Uvex Stealth Goggles provide superior eye protection during impact, dust and chemical splash applications. These goggles feature an adjustable neoprene headband and soft elastomer frame that contours to your face for a gap-free fit. Their modern low-profile wrap-around design offers a full field of vision, while their indirect venting minimizes fogging.



Honeywell

FEATURES & BENEFITS

- HydroShield® anti-fog coating for long lasting fog-free time and scratch resistance
- Toric lens provide superior optics and peripheral vision
- Indirect ventilation system minimizes fogging
- Quick-adjust headband clips for fast and easy fitting

CERTIFICATIONS

- Meets ANSI Z87+ (High Impact) and is CSA Z94.3 certified

C&M PART #	MFG PART #	DESCRIPTION
101312	S3960HS	Gray Frame, Clear Lens with HydroShield Anti-Fog Coating

REPLACEMENT PARTS & ACCESSORIES

C&M PART #	MFG PART #	DESCRIPTION
100248	LCD100	100 Count Lens Cleaning Wipes

Radians® Cloak™ Dual Mold Goggles

The Cloak Dual Mold Protective Goggles provide better impact, dust and chemical splash protection than safety glasses. Safety goggles should be used when there are more than occasional particle hazards.



RADIANS

FEATURES & BENEFITS

- Molded rubber lining provides a soft, comfortable seal
- Adjustable Neoprene head strap provides a comfortable, adjustable fit
- Impact-resistant polycarbonate lens
- Perimeter ventilation allows air to flow around lens preventing fogging along with anti-fog lens coating
- Clip attachment allowing for easy lens replacement
- Provides 99.9% UVA/UVB protection

CERTIFICATIONS

- Polycarbonate protective lens meets ANSI Z87.1+ standards

C&M PART #	MFG PART #	DESCRIPTION
100500	DMG-11	Gray Frame, Clear Anti-Fog Lens
100499	DMG-21	Gray Frame, Smoke Anti-Fog Lens

DeWALT® DPG84 Insulator™ Protective Eyewear



DEWALT

The DPG84 Insulator Protective Eyewear is designed for workers who don't have time for goggles that interfere with their headgear or fog up during strenuous tasks. This low-profile goggles features a premium anti-fog and anti-scratch coating to help workers see clearly. A soft rubber gasket creates a comfortable seal against splash, droplets, dust, and debris, providing for a D3 and D4 rating. An adjustable cloth head strap provides a custom, secure fit.

FEATURES & BENEFITS

- Premium anti-fog, anti-scratch coating
- Soft rubber gasket seal for comfortable seal against dust and debris
- Low-profile frame for minimal headgear interference
- Provides 99.9% UVA/UVB protection

CERTIFICATIONS

- Polycarbonate lens meets ANSI Z87.1+ standards

C&M PART #	MFG PART #	DESCRIPTION
100045	DPG84-13D	Black/Yellow Frame, Clear Anti-Fog Lens

Radians® Rad-Sequel™ Safety Eyewear



The Rad-Sequel safety glasses have a lightweight design for a comfortable fit. Rubber-tipped temples and a soft rubber nose piece gives this glass a secure fit for all day wear.

FEATURES & BENEFITS

- Rubber-tipped temples provide a secure fit
- Impact-resistant polycarbonate lens offers excellent protection
- Provides 99.9% UVA/UVB protection

CERTIFICATIONS

- Meet ANSI Z87.1+ standards

C&M PART #	MFG PART #	DESCRIPTION
100534	RS1-10	Clear Frame, Clear Lens
100533	RS1-11	Clear Frame, Clear Anti-Fog Lens
100535	RS1-20	Smoke Frame, Smoke Lens
100537	RS1-21	Smoke Frame, Smoke Anti-Fog Lens
100536	RS1-90	Indoor/Outdoor Frame, Indoor/Outdoor Lens

Radians® Rad-Sequel RSx™ Bi-Focal Safety Eyewear



The Rad-Sequel RSx Bi-Focal safety glasses feature a magnification diopter molded directly into protective safety lens so there is no need for additional prescription reading glasses!

FEATURES & BENEFITS

- Magnification diopter molded directly into protective safety lens
- Cushioned, nonslip rubber tipped temples provide a secure fit
- Soft, rubber nose piece provides all day comfort
- Lightweight design provides a comfortable fit
- Polycarbonate protective safety lens provides impact resistance

CERTIFICATIONS

- Meets or exceeds ANSI Z87.1 + standard

C&M PART #	MFG PART #	DESCRIPTION
100067	RSB-110	Clear Frame, Clear Lens, 1.0 Diopter
100066	RSB-115	Clear Frame, Clear Lens, 1.5 Diopter
100069	RSB-120	Clear Frame, Clear Lens, 2.0 Diopter
100068	RSB-125	Clear Frame, Clear Lens, 2.5 Diopter
100065	RSB-130	Clear Frame, Clear Lens, 3.0 Diopter

Radians® Rad-Atac™ Safety Eyewear



The Rad-Atac safety glasses have a wraparound single lens with integrated nose piece.

FEATURES & BENEFITS

- Soft, nonslip rubber tipped temples
- Impact-resistant polycarbonate lens offers excellent protection
- Provides 99.9% UVA/UVB protection

CERTIFICATIONS

- Meet ANSI Z87.1+ standards

C&M PART #	MFG PART #	DESCRIPTION
100072	AT1-10	Clear Frame, Clear Lens
100071	AT1-11	Clear Frame, Clear Anti-Fog Lens
100074	AT1-20	Smoke Frame, Smoke Lens
100073	AT1-21	Smoke Frame, Smoke Anti-Fog Lens
100070	AT1-90	Indoor/Outdoor Frame, Indoor/Outdoor Lens

Radians® Rad-Sequel™ IQ - IQUNITY™ Anti-Fog Safety Eyewear



The Rad-Sequel IQ safety glasses feature the new IQunity anti-fog coating which provides one of the most superior and long-lasting anti-fog coatings in the market. The water-based coating lasts much longer because the anti-fog and anti-scratch properties are built into the lens for long-term wear and durability. A lightweight design, rubber tipped temples and a soft rubber nose piece gives this glass a secure fit for all day wear.

FEATURES & BENEFITS

- IQunity semi-permanent anti-fog and anti-scratch hydrophilic coating lasts longer than hydrophobic coatings
- Environmentally friendly, nontoxic and nonflammable, unlike highly toxic solvent-based coatings
- Impact-resistant polycarbonate lens offers excellent protection
- Provides 99.9% UVA/UVB protection

CERTIFICATIONS

- Meet ANSI Z87.1+ standards

C&M PART #	MFG PART #	DESCRIPTION
100365	RS1-13	Clear Frame, Clear IQ Anti-Fog Lens
100364	RS1-23	Smoke Frame, Smoke IQ Anti-Fog Lens

Radians® Rad-Apocalypse™ Safety Eyewear



The Rad-Apocalypse safety glasses have a sleek, sporty, lightweight style and come with a safety neck cord. Hard coated polycarbonate lenses provide impact resistance, scratch resistance and UV protection.

FEATURES & BENEFITS:

- Soft rubber temples with flared ends offer excellent comfort and fit
- Neck cord included
- Hard coated, impact-resistant polycarbonate lens
- Provides 99.9% UVA/UVB protection

CERTIFICATIONS

- Meets ANSI Z87.1+ standards

C&M PART #	MFG PART #	DESCRIPTION
100235	AP1-10	Black Frame, Clear Lens
100236	AP1-11	Black Frame, Clear Anti-Fog Lens
100237	AP1-20	Black Frame, Smoke Lens
100238	AP1-21	Black Frame, Smoke Anti-Fog Lens
100239	AP1-90	Black Frame, Indoor/Outdoor Lens

DeWALT® DPG100 Crosscut® Premium Safety Eyewear



The DPG100 Crosscut safety glasses with the wide lenses offer excellent sight lines and side protection. The rubber no-slip temples and a soft nose piece provide a comfortable fit.

FEATURES & BENEFITS

- Wide wrap lenses
- Soft rubber nose piece
- Comfort fit temples
- Impact-resistant polycarbonate lenses
- Provides 99.9% UVA/UVB protection

CERTIFICATIONS

- Safety glass exceeds ANSI Z87.1+ standards

C&M PART #	MFG PART #	DESCRIPTION
100271	DPG100-1D	Black Frame, Clear Lens
100269	DPG100-2D	Black Frame, Smoke Lens
100270	DPG100-9D	Black Frame, Indoor/Outdoor Lens

Radians® Mirage™ Safety Eyewear



The sleek design of the Mirage safety glasses makes these perfect for both men and women. Weighing less than one ounce, they are very comfortable for all day wear.

FEATURES & BENEFITS

- Sleek, lightweight design offers a comfortable fit
- Optically correct and distortion free lenses
- Economical dual wraparound 9.75 base lens provides near perfect orbital seal
- Protective polycarbonate lens provides impact resistance
- Provides 99.9% UVA/UVB protection

CERTIFICATIONS

- Meets ANSI Z87.1+ standards

C&M PART #	MFG PART #	DESCRIPTION
100342	MR0120ID	Smoke Frame, Smoke Lens
100343	MR0110ID	Smoke Frame, Smoke Anti-Fog Lens
100344	MR0190ID	Clear Frame, Clear Lens
100345	MR0121ID	Clear Frame, Clear Anti-Fog Lens
100346	MR0191ID	Indoor/Outdoor Frame, Indoor/Outdoor Lens
100347	MR0111ID	Indoor/Outdoor Frame, Indoor/Outdoor Anti-Fog Lens

Radians® Mirage™ Foam Safety Eyewear



The Mirage Foam Safety Eyewear with foam-lined channels block debris, airborne particles, and eye irritants. Sleek, light, comfortable safety glasses feature foam lined vents to filter air for maximum fog control.

FEATURES & BENEFITS

- Closed cell foam-lined channels block debris and eye irritants
- Full wraparound frame allows for unobstructed peripheral vision
- Tiny foam-lined pockets/vents provide extra fog control
- Polycarbonate lens provides impact protection

CERTIFICATIONS

- Meets ANSI Z87.1+ standards

C&M PART #	MFG PART #	DESCRIPTION
100279	MRF111ID	Clear Frame, Clear Anti-Fog Lens
100281	MRF121ID	Smoke Frame, Smoke Anti-Fog Lens
100280	MRF191ID	Indoor/Outdoor Frame, Indoor/Outdoor Anti-Fog Lens

Radians® Crossfire® Infinity Premium Safety Eyewear



The stylish full frame Crossfire Infinity safety glasses come in various options including polarized. Vented noses piece and rubber temple provide a comfortable fit for all day wear.

FEATURES & BENEFITS

- Vented rubber nose piece for better air circulation
- Dual mold, rubber temple grips for better stability
- Polarized lens option
- Hard coat polycarbonate lens protects against scratches
- Provides 99.9% UVA and UVB protection

CERTIFICATIONS

- Complies with ANSI Z87.1 standards

C&M PART #	MFG PART #	DESCRIPTION
100340	21126	Crystal Brown Frame, Polarized HD Brown Lens
100341	241	Crystal Black Frame, Smoke Lens

DeWALT® DPG95 Framework™ Safety Eyewear



The DPG95 Framework safety glasses have Foam Shield® lining to provide a comfortable, snug fit with the added dust and debris protection of safety goggles.

FEATURES & BENEFITS

- Foam Shield® lining offers added dust and debris protection
- Elastic head strap provides an adjustable, secure fit
- Interchangeable with easy snap on/off Double Duty® temples and elastic head strap
- Impact-resistant tough polycarbonate lens
- Protects against harmful UV rays

CERTIFICATIONS

- Meets ANSI Z87.1+ standards

C&M PART #	MFG PART #	DESCRIPTION
100539	DPG95-11D	Silver Frame, Clear Anti-Fog Lens
100538	DPG95-2D	Silver Frame, Smoke Lens

Radians® Crossfire® ES5 Premium Safety Eyewear



The Crossfire ES5 safety glasses feature an adjustable nose piece, ultralight frame, and 100% visually correct lenses packaged in a stylish design. The sleek framework provides substantial coverage for a variety of environments. This model is available with a polarized lens.

FEATURES & BENEFITS

- Rubber nose piece for all day comfort
- Dual mold, rubber temple grips for better stability
- Polarized lens option—excellent for outdoor work
- Hard coat polycarbonate lens protects against scratches
- Provides 99.9% UVA and UVB protection

CERTIFICATIONS

Complies with ANSI Z87.1 standards

C&M PART #	MFG PART #	DESCRIPTION
100202	2961	Pearl Black Frame, Smoke Lens
100203	291113	Crystal Brown Frame, Polarized Brown Lens

Radians® Extremis® Safety Eyewear



The Extremis safety glasses are sleek, modern, and stylish, yet integrates the compliance and comfort elements end users demand from a safety glasses. Foam-lined frame offers protection from dust and debris as well as comfortable wear.

FEATURES & BENEFITS

- Foam-lined frame provides extra protection against dust and debris
- Soft rubber nose pads provide a comfortable fit
- Full frame with polycarbonate lens offers a stylish look with impact protection
- Provides 99.9% UV protection

CERTIFICATIONS

- Meets ANSI Z87.1+ standards

C&M PART #	MFG PART #	DESCRIPTION
100666	XT1-11	Black Frame, Clear Anti-Fog Lens
100665	XT1-21	Black Frame, Smoke Anti-Fog Lens
100667	XT1-91	Black Frame, Indoor/Outdoor Anti-Fog Lens

Radians® Crossfire® Cumulus Premium Safety Eyewear



The stylish design of the full frame Crossfire Cumulus is designed for maximum protection. The soft, rubber nose piece allows for all day comfort and the dual mold rubber temples provide grip for better stability.



FEATURES & BENEFITS

- Rubber nose piece for all day comfort
- Dual mold, rubber temple grips for better stability
- Hard coat polycarbonate lens protects against scratches
- Provides 99.9% UVA and UVB protection

CERTIFICATIONS

- Complies with ANSI Z87.1 standards

C&M PART #	MFG PART #	DESCRIPTION
100075	41626	Matte Black Frame, Blue Mirror Lens
100076	411432	Camo Frame, Gold Mirror Lens
100077	41291	Aluminum Gray Frame, Smoke Lens

Honeywell Uvex Seismic® Sealed Eyewear



The Uvex Seismic eyewear features high-quality face-cushioning foam, flexible nasal pads and adjustable headband to provide premium comfort and seal out dust and debris. It has cushioned-lined subframe and a removable headband for all-day comfort. Top and bottom indirect ventilation minimize fogging for clearer, safer vision.

FEATURES & BENEFITS

- Soft, high-quality face cushioning and padded temple tips offer all-day comfort
- Flexible nasal pads easily conform to a variety of facial profiles
- Use with temple or headband (both included) and with or without cushioned frame
- Provides 99.9% UVB/UVA protection

CERTIFICATIONS

- ANSI Z87.1+, CSA Z94.3 certified

C&M PART #	MFG PART #	DESCRIPTION
101292	SO600	Black Frame, Clear Lens, Hardcoat
101293	SO600HS	Black Frame, Clear Lens, HydroShield® Anti-Fog

Honeywell Uvex SVP 200 Series



Uvex SVP 200 offers stylish, low-profile, and very lightweight fit for all day comfort. It has flexible temple tips, 10-base, dielectric, wraparound frameless style, and molded nosepiece.

FEATURES & BENEFITS

- Stylish, extremely lightweight and 10-base wrap-around frameless style for a comfortable wear
- Flexible temple tips for secure fit
- Molded nose piece
- Provides > 99.9% UVB/UVA protection

CERTIFICATIONS

- ANSI Z.87.1 and CSA Z94.3 certified

C&M PART #	MFG PART #	DESCRIPTION
101304	SVP200	Clear Frame, Clear Lens, Hardcoat
101305	SVP201	Clear Frame, Clear Lens, Anti-Fog
101306	SVP202	Gray Frame, Shaded Lens, Hardcoat
101307	SVP203	Gray Frame, Shaded Lens, Anti-Fog

DeWALT® DPG107 Supervisor® Premium Safety Eyewear



The DPG107 Supervisor safety glasses feature an iconic, stylish design. This eyewear pairs a lightweight polycarbonate full frame with 100% visually correct plano lenses to provide protection and full day comfort. The DPG107 meets the Z87.1 standard for impact protection and provides 99% UV protection.



FEATURES & BENEFITS

- Iconic classic style
- Lightweight and comfort flex temples for all day comfort
- Integrated nose piece
- Provides 99.9% UV protection

CERTIFICATIONS

- Meets the Z87.1 standards

C&M PART #	MFG PART #	DESCRIPTION
100657	DPG107-ID	Black Frame, Clear Lens
100658	DPG107-YD	Black Frame, Yellow Mirror Lens
100659	DPG107-2D	Black Frame, Smoke Lens



DeWALT® DPG101 Auger® Safety Eyewear



The DPG101 Auger safety glasses with its full wraparound design provide excellent protection. No-slip temple grip helps glasses stays in place.



FEATURES & BENEFITS

- Impact-resistant polycarbonate lenses offer excellent protection
- Comfort fit rubber nose piece for all day wear
- Provides 99.9% UVA/UVB protection

CERTIFICATIONS

- Safety glass exceeds ANSI Z87.1+ standards

C&M PART #	MFG PART #	DESCRIPTION
100502	DPG101-2D	Black Frame, Smoke Lens
100503	DPG101-6D	Black Frame, Silver Mirror Lens
100501	DPG101-9D	Black Frame, Indoor/Outdoor Lens

Radians® Thraxus™ Safety Eyewear



The Thraxus safety eyewear is the next generation of highly protective, ultra comfortable and super stylish safety eyewear. The new IQuity™ coating provides one of the most superior and long-lasting anti-fog coatings in the market. The water-based coating lasts much longer because the anti-fog and anti-scratch properties are built into the lens for long-term wear and durability.

FEATURES & BENEFITS:

- IQuity semi-permanent anti-fog and anti-scratch hydrophilic coating lasts longer than hydrophobic coatings
- Environmentally friendly, nontoxic and nonflammable, unlike highly toxic solvent-based coatings
- Provides 99.9% UV protection

CERTIFICATIONS

- EN166K compliant, N complaint, CSA Z94.3 compliant, meets ANSI Z87.1 standards

C&M PART #	MFG PART #	DESCRIPTION
100211	TXC1-131D	Black Frame, Clear IQ Anti-Fog Lens
100210	TXC1-231D	Black Frame, Smoke IQ Anti-Fog Lens

DeWALT® DPG102 Recip Safety Glass



The DPG102 Recip safety glasses provide excellent protection with its comfortable, lightweight frame and adjustable temples. Full wraparound frame ensures unobstructed peripheral vision.

FEATURES & BENEFITS

- Rubber temple grips for a secure fit
- Impact-resistant polycarbonate lenses provide added protection
- Soft, adjustable rubber nose piece
- Extended lens protection

C&M PART #	MFG PART #	DESCRIPTION
100086	DPG102-2D	Smoke Frame, Smoke Lens
100085	DPG102-9D	Indoor/Outdoor Frame, Indoor/Outdoor Lens

Radians® Lens Cleaning Towelettes

The specially developed formula in the lens cleaning towelettes clean greasy and oily glasses while providing an anti-fog / anti-static coating. Low lint, non-abrasive tissue leaves lenses clear and streak free.



FEATURES & BENEFITS

- Easy-to-use disposable towelettes come in a convenient dispenser box
- Lens cleaning towelettes prevent fogging and reduce static
- Excellent for cleaning glass, plastic and polycarbonate

C&M PART #	MFG PART #	DESCRIPTION
100248	LCD100	Lens Cleaning Towelettes, Box of 100

Allegro Eyewear Cleaning Wipes

Perfect for cleaning eyewear, these 100 individually wrapped premoistened wipes feature anti-fog, anti-static and silicone-free cleaning. Excellent on glass or polycarbonate lenses, the large 5" x 8" wipes are stored in a wall-mounted cardboard dispenser.



FEATURES & BENEFITS

- Excellent on glass or polycarbonate lenses
- Non-woven material doesn't leave any residue

C&M PART #	MFG PART #	DESCRIPTION
105060	350	Cleaning Wipes

Guardian Heated Portable Eyewash/Drench Hose Unit

This electrically heated and insulated Portable Eyewash/Drench Hose Unit helps you stay ANSI Z358.1-2014 compliant in areas where ambient temperatures may drop below the tepid range (60 to 100°F). In extreme conditions, the heating system will also protect the unit against freezing. The silicone drum heater's thermostat is set to 65°F and automatically turns the heater on and off to maintain the temperature.

Use the spray head and drench hose combination to effectively rinse eyes, face and body. The maneuverable 42-lb unit uses air pressure to deliver 10 gallons of water at 0.7 gallons/min for 15 minutes. Heater requires 120 VAC, 15 amp power source and has a 9-ft long cord with GFCI plug and manual reset.

FEATURES & BENEFITS

- Two GS-Plus™ low flow spray heads with “flip top” dust covers and integral flow controls
- Filters remove impurities from the water flow
- High visibility orange insulated nylon jacket contains heat, is waterproof and resistant to mildew
- Unit is assembled and factory tested before shipment

INCLUDES

ANSI-compliant identification sign and inspection tag, bacteriostatic additive and 9-ft power cord with GFCI plug

SPECIFICATIONS

TANK MATERIAL	Stainless Steel
INTERNAL BALL VALVE MATERIAL	Chrome Plated Brass
SPRAY HEAD MATERIAL	Polypropylene

C&M PART #	MFG PART #	CAPACITY (GAL)
400211	G1562HTR	15



Radians Eyewash Stations



Compact and easy to mount, these personal eyewash stations are perfect for immediate flushing of eyes in an emergency, until the injured person can be helped to a proper eyewash station.

FEATURES & BENEFITS

- Conveniently mounts to wall for easy access
- Bright green color makes eyewash easy to locate in an emergency
- Easily removable bottle snaps securely in place
- Bottles dated for freshness

C&M PART #	MFG PART #	DESCRIPTION
100082	REW16S	Eyewash Station, Single, 16 oz
100084	REW32S	Eyewash Station, Single, 32 oz
100083	REW16D	Eyewash Station, Double, 16 oz
100081	REW32D	Eyewash Station, Double, 32 oz

Honeywell® Sterile Eyesaline® Eyewash Bottles

Place personal eyewash bottles closer to contaminants so immediate treatment can be provided in case of an accident. While not intended to replace the primary eyewash equipment, these bottles are an important supplement for the injured worker before accessing the primary eyewash equipment. They are also great for using while the injured worker is being transported to medical care.



FEATURES & BENEFITS

- Extended-flow nozzles provides longer flow than conventional eyewash containers
- Buffered, sterile saline solution is superior to tap water for emergency eye care
- Tamper-resistant blow-fill-seal can be easily removed in an emergency

INCLUDES

12 bottles

C&M PART #	MFG PART #	DESCRIPTION
111174	32-000454-0000-H5	Portable Sterile Eyewash Bottle, 16 oz.
111175	32-000455-0000-H5	Portable Sterile Eyewash Bottle, 32 oz.

Guardian Portable Eyewash/Drench Hose Unit

This Portable Eyewash Station is ideal for keeping low-hazard worksites OSHA and ANSI Z358.1-2014 compliant when a continuous supply of water is not available. The maneuverable 35-lb (116 lbs filled) unit uses air pressure to deliver 10 gallons of water at 0.7 gallons/min for 15 minutes. Spray head and drench hose combination allows for the effective rinsing of eyes, face and body.

FEATURES & BENEFITS

- Perfect portable eyewash station for low-hazard worksites
- Two GS-Plus™ low-flow spray heads with “flip top” dust covers and integral flow controls
- Filters remove impurities from the water flow
- User’s hands are free while eyewash is in operation
- Unit is assembled and factory tested before shipment

INCLUDES

ANSI-compliant identification sign, inspection tag and bacteriostatic additive

SPECIFICATIONS

TANK MATERIAL	Stainless Steel
INTERNAL BALL VALVE MATERIAL	Chrome Plated Brass
SPRAY HEAD MATERIAL	Polypropylene

C&M PART #	MFG PART #	CAPACITY (GAL)
400210	G1562	15



Guardian Combination Safety Stations

Quickly wash away contaminants on the body or eyes with the Guardian Combination Safety Station. The combination safety stations include both a safety shower and eyewash station and are ANSI Z358.1-2014 compliant. Shower head has internal 20 GPM flow control and eye/face wash has internal 1.6 GPM flow control per spray head. Select PVC unit (400213) for use in industrial environments where harsh acids or caustics are present; stainless steel unit (400212) is ideal for corrosive and cleanroom environments.



FEATURES & BENEFITS

- Two GS-Plus™ low flow eyewash spray heads with “flip top” dust covers and integral flow controls
- Filters remove impurities from the water flow
- Valve and spray head assemblies are factory assembled and water tested prior to shipment
- 2-year warranty

C&M PART #	MFG PART #	VALVE MATERIAL	SHOWER HEAD MATERIAL	BOWL DIAMETER	BOWL MATERIAL	PIPE & FITTINGS MATERIAL
400191	G1902	Chrome plated brass	ABS Plastic	11-1/8"	SS	Schedule 40 galvanized steel w/ orange PE pipe cover
400192	G1902P	Chrome plated brass	ABS Plastic	11-3/4"	ABS Plastic	Schedule 40 galvanized steel w/ orange PE pipe cover
400193	G1902BC	Chrome plated brass	ABS Plastic	11-1/2"	SS with Cover	Schedule 40 galvanized steel w/ orange PE pipe cover
400213	G1990	316 SS	ABS Plastic	11-3/4"	ABS Plastic	Schedule 80 PVC
400212	G1991	316 SS	SS	11-1/8"	SS	Schedule 40 Type 304 brushed SS with orange PE pipe cover

SS: stainless steel; PE: polyethylene

INCLUDES

ANSI-compliant identification sign

SPECIFICATIONS

SHOWER HEAD DIAMETER	10"
SPRAY HEAD MATERIAL	Polypropylene
SUPPLY INLET TYPE	1-1/4" NPT(F)
WASTE OUTLET TYPE	1-1/4" NPT(F)

REPLACEMENT PARTS & ACCESSORIES

C&M PART #	MFG PART #	DESCRIPTION
400197	G6020	Thermostatic Mixing Valve, 13 Gallon Capacity
400198	G6040	Thermostatic Mixing Valve, 50 Gallon Capacity
400205	AP275-705	Strobe Light and Alarm Horn w/ Weatherproof Remote Sensing Flow Switch
400206	AP275-705N4X	Strobe Light and Alarm Horn, NEMA-4X Rated Components
400207	AP275-705CID2	Strobe Light and Alarm Horn, CID2 Rated Components

Guardian Pedestal Mounted Eyewash Stations



Free standing Pedestal Mounted Eyewash Stations are perfect for areas where an eyewash and shower combination unit is not necessary. These easy-to-use eyewash stations help ensure worker safety and stay compliant.

FEATURES & BENEFITS

- Two GS-Plus™ low flow spray heads with “flip top” dust covers and integral flow controls
- Filters remove impurities from the water flow
- Furnished with orange pipe covers for high visibility and corrosion resistance
- Stay open ball valve allows for hands-free operation
- Valve, bowl and spray head assembly is factory assembled and water tested prior to shipment

INCLUDES

ANSI-compliant identification sign and inspection tag

SPECIFICATIONS

SPRAY HEAD MATERIAL	Polypropylene
VALVE MATERIAL	Chrome Plated Brass
PIPE & FITTINGS MATERIAL	Schedule 40 Galvanized Steel
SUPPLY INLET	1/2" NPT(F)
WASTE OUTLET	1-1/4" NPT(F)

C&M PART #	MFG PART #	BOWL TYPE	BOWL DIAMETER
400188	G1825	Stainless Steel	11-1/8"
400189	G1825P	ABS Plastic	11-3/4"
400190	G1825BC	Stainless Steel w/ Cover	11-1/2"

REPLACEMENT PARTS & ACCESSORIES

C&M PART #	MFG PART #	DESCRIPTION
400197	G6020	Thermostatic Mixing Valve, 13 Gallon Capacity
400198	G6040	Thermostatic Mixing Valve, 50 Gallon Capacity

Guardian Wall-Mounted Eyewash Stations



The Wall-Mounted Eyewash Stations conveniently set up out of the way while remaining easily accessible in case of an emergency. These stations are perfect for areas where an eyewash and shower combination unit is not necessary. Heavy-duty cast aluminum wall bracket with corrosion-resistant powder-coat finish makes mounting simple.

FEATURES & BENEFITS

- Two GS-Plus™ low flow spray heads with “flip top” dust covers and integral flow controls
- Filters remove impurities from the water flow
- Stay open ball valve allows for hands-free operation
- Unit is completely assembled and tested prior to shipment

INCLUDES

ANSI-compliant identification sign, inspection tag and wall bracket

SPECIFICATIONS

SPRAY HEAD MATERIAL	Polypropylene
VALVE MATERIAL	Chrome Plated Brass
SUPPLY INLET	1/2" NPT(F)
WASTE OUTLET	1-1/4" NPT(F)

C&M PART #	MFG PART #	BOWL TYPE	BOWL DIAMETER
400185	G1814	Stainless Steel	11-1/8"
400186	G1814P	ABS Plastic	11-3/4"
400187	G1814BC	Stainless Steel w/ Cover	11-1/2"

REPLACEMENT PARTS & ACCESSORIES

C&M PART #	MFG PART #	DESCRIPTION
400197	G6020	Thermostatic Mixing Valve, 13 Gallon Capacity
400198	G6040	Thermostatic Mixing Valve, 50 Gallon Capacity

HOW TO ORDER



ONLINE

supply.coreandmain.com



TELEPHONE

1-888-885-2673



EMAIL

support.supply@coreandmain.com

HOURS OF OPERATION: M-F; 6 A.M. to 7 P.M. CST



Guardian Eyewash/Drench Hose Units



These dual-purpose Eyewash/Drench Hose Units meet the provisions of ANSI Z358.1-2014 as both an eyewash and a drench hose. Locking clip engages when handle is depressed, providing “hands free” operation. Valve stays open until locking ring is released. Alternatively, unit may be removed for use as a drench hose to rinse any part of the user’s eyes, face or body.

FEATURES & BENEFITS

- Two GS-Plus™ low flow spray heads with “flip top” dust covers and integral flow controls
- Filters remove impurities from the water flow
- Units are completely assembled and water tested prior to shipment

INCLUDES

All units include ANSI-compliant identification sign; Deck unit comes with deck flange for mounting; wall unit comes with a bracket with spring clips for mounting

SPECIFICATIONS

SPRAY HEAD MATERIAL	Polypropylene
VALVE MATERIAL	Forged Brass
SUPPLY INLET	3/8" NPT(M)
HOSE TYPE	8-ft L Reinforced PVC, 275 PSI (Max Working)

C&M PART #	MFG PART #	DESCRIPTION
400208	G5022	Deck-Mounted Unit
400209	G5026	Wall-Mounted Unit

REPLACEMENT PARTS & ACCESSORIES

C&M PART #	MFG PART #	DESCRIPTION
400197	G6020	Thermostatic Mixing Valve, 13 Gallon Capacity
400198	G6040	Thermostatic Mixing Valve, 50 Gallon Capacity



Helpful Tip:
Keep your Eye Protection Clean

Always keep your eye protection clean... We recommend Radians (Item# 100248) and Allegro Ind (Item# 105060) Lens Clean Wipes.

See page 326 for details!

Guardian Heat-Traced Combination Safety Stations

The Guardian Heat-Traced Safety Station with an eyewash, shower and top inlet are heated to prevent freezing in cold temperatures. Thermostat-regulated units are heated by a self-limiting heat-tracing cable wrapped around the internal pipe to prevent freezing even at -40°F. Unit is fully wired at the factory and requires 120 VAC single phase power supply. Shower head is 10" ABS plastic with internal 20 GPM flow control; freeze-resistant eyewash spray head assembly comes with float-off dust covers and internal flow control.



FEATURES & BENEFITS

- Ideal for use in areas emergency stations need protection from freezing
- ‘Tempering valves’ section to ensure tepid water compliance with ANSI Z358.1-2014
- Shower and eyewash valves are US-made with brass ball and PTFE seals
- Jacket/insulation is UV-resistant orange ABS plastic with polyethylene foam insulation

INCLUDES

ANSI-compliant identification sign

SPECIFICATIONS

SHOWER HEAD DIAMETER	10"
SPRAY HEAD MATERIAL	Chrome Plated Brass
SUPPLY INLET TYPE	1-1/4" NPT(F) Top Inlet
VALVE MATERIAL	Brass
PIPE & FITTINGS MATERIAL	Schedule 40 Galvanized Steel

CERTIFICATIONS

- FM, UL and CSA approved for Class I, Division 2, Groups B, C and D

C&M PART #	MFG PART #	ALARM OPTION INCLUDED
400199	GFR3100	None
400200	GFR3107	Alarm horn, light and remote sensing

REPLACEMENT PARTS & ACCESSORIES

C&M PART #	MFG PART #	DESCRIPTION
400197	G6020	Thermostatic Mixing Valve, 13 Gallon Capacity
400198	G6040	Thermostatic Mixing Valve, 50 Gallon Capacity
400205	AP275-705	Strobe Light and Alarm Horn w/ Weatherproof Remote Sensing Flow Switch
400206	AP275-705N4X	Strobe Light and Alarm Horn, NEMA-4X Rated Components
400207	AP275-705CID2	Strobe Light and Alarm Horn, CID2 Rated Components



Guardian Freeze & Scald Resistant Combination Safety Stations

Guardian combination safety stations can be outfitted to keep you and your team safe in extreme work environments, as well as keep your work site ANSI Z358.1-2014 compliant. The dangerous issue of freezing and scalding water in a safety station are no problem for the following Guardian combination safety stations.

The Guardian **Freeze-Resistant Safety Station** (400201) has its freeze-resistant valves and supply lines buried below the frost line to protect against freezing. Unit is designed to drain completely after use, so that no standing water remains in unit and possibility of freeze-up is eliminated. Since unit is intended for use in cold weather conditions, consideration should be given to supplying unit with tempered water in accordance with ANSI Z358.1-2014. See part numbers 400197 and 400198 for more information on Guardian thermostatic mixing valves.

The Guardian **Freeze Protection Safety Station** (400194) features a temperature-actuated freeze protection valve. When the water temperature drops below 40°F, the valve automatically opens to allow water to circulate through the unit, preventing water from freezing. The unit is designed so that when the drain valve is open, there are no “dead legs” of water standing in the unit. Water flow stops when the water temperature rises above 40°F.

The Guardian **Scald Protection Safety Station** (400196) is furnished with a temperature-actuated scald protection valve. When water temperature rises above 95°F, valve automatically opens to allow water to circulate through unit, preventing injury to user. Unit is designed so that when drain valve is open, there are no “dead legs” of water standing in unit. Water flow stops when temperature falls below 95°F.

The Guardian **Freeze/Scald Protection Safety Station** (400195) includes temperature-actuated freeze and scald protection valves. When the water temperature drops below 40°F or rises above 95°F, the drain valve automatically opens to allow water to circulate through the unit. The unit is designed so that, when the drain valve is open, there are no “dead legs” of water standing in unit. Water circulates until water temperatures returns to within the 40°F and 95°F range.

FEATURES & BENEFITS

- Two GS-Plus™ low flow eyewash spray heads with “flip top” dust covers and integral flow controls
- Filters remove impurities from the water flow
- Valve and spray assemblies are factory assembled and water tested prior to shipment
- 2-year warranty

INCLUDES

ANSI-compliant identification sign



SPECIFICATIONS

SHOWER HEAD DIAMETER	10"
SHOWER HEAD MATERIAL	ABS Plastic
EYEWASH BOWL DIAMETER	11-1/8"
EYEWASH BOWL MATERIAL	Stainless Steel
SPRAY HEAD MATERIAL	Polypropylene
PIPE & FITTINGS MATERIAL	Schedule 40 Galvanized Steel w/ Orange Polyethylene Pipe Cover
WASTE OUTLET	1-1/4" NPT(F)

C&M PART #	MFG PART #	DESCRIPTION	VALVE MATERIAL	SUPPLY INLET(S)
400201	GFR1902	Freeze-Resistant Safety Station	Brass	Eyewash Valve: 3/4" NPT(F); Shower Valve: 1-1/4" NPT(M)
400194	G1941	Freeze Protection Safety Station	US-Made Chrome Plated Brass	1-1/4" NPT(F) Top Inlet
400196	G1943	Scald Protection Safety Station	US-Made Chrome Plated Brass	1-1/4" NPT(F) Top Inlet
400195	G1942	Freeze/Scald Protection Safety Station	US-Made Chrome Plated Brass	1-1/4" NPT(F) Top Inlet

REPLACEMENT PARTS & ACCESSORIES

C&M PART #	MFG PART #	DESCRIPTION
400197	G6020	Thermostatic Mixing Valve, 13 Gallon Capacity
400198	G6040	Thermostatic Mixing Valve, 50 Gallon Capacity
400205	AP275-705	Strobe Light and Alarm Horn w/ Weatherproof Remote Sensing Flow Switch
400206	AP275-705N4X	Strobe Light and Alarm Horn, NEMA-4X Rated Components
400207	AP275-705CID2	Strobe Light and Alarm Horn, CID2 Rated Components

Guardian Thermostatic Mixing Valves



The Guardian thermostatic mixing valves blend hot and cold water to deliver tepid water helping keep your team safe and your emergency shower and eyewash stations ANSI Z358.1-2014 compliant. Valves are engineered specifically for the critical demands of supplying your emergency shower or combination safety station. Depending on water supply size and pressure, valve may be able to supply multiple units.

FEATURES & BENEFITS

- Precision control thermal actuator senses incoming water temperature and automatically blends water to preset temperature
- If hot water supply is restricted or interrupted, internal bypass allows the valve to deliver cold water only
- If cold water supply is restricted or interrupted, the valve will close completely and not deliver any water at all, eliminating risk of scalding
- Valve is fully assembled and factory tested prior to shipment
- Valve meets the requirements of the US Safe Drinking Water Act as lead-free

CERTIFICATIONS

- ANSI/ASSE 1071

C&M PART #	MFG PART #	FLOW CAPACITY (GPM) PER 30 PSI PRESSURE DROP	INLET / OUTLET
400197	G6020	13	1/2" NPT(F)
400198	G6040	50	1/1-1/4" NPT(F)

Guardian Strobe Light & Alarm Horn Combination Units

The Guardian strobe light and alarm horn combination units help bring attention to emergency situations by alerting people in an area that an emergency safety station has been activated. Ideal for use in high traffic industrial applications, large spaces, areas with high ambient light and areas with high noise levels. Combination unit comes standard with additional contacts for connection to a remote monitoring system.



Use NEMA-4X unit (400206) in areas where corrosive materials and caustic cleaners such as disinfectants are used. Class I, Division 2 unit (400207) is ideal for use in CID2 hazardous environments where flammable liquids or gases are not present during normal operating conditions. All units require 120 VAC, 0.3 amp electrical supply.

FEATURES & BENEFITS

- Weatherproof amber strobe light with shatter-resistant lens
- Weatherproof horn delivers distinctive, urgent signal
- NEMA-4X unit (400206) for use in areas where corrosive materials and caustic cleaners are used
- Class I, Division 2 unit (400207) for CID2 settings where flammable liquids or gasses are not present during normal operating conditions
- Units are fully assembled, wired and factory tested prior to shipment

INCLUDES

Mounting bracket

C&M PART #	MFG PART #	COMPONENT PROTECTION	VISUAL CANDLE POWER	VISUAL FLASH RATE (FPM)	AUDIBLE SIGNAL*
400205	AP275-705	None	1,400,000	65	100 db at 10 ft
400206	AP275-705N4X	NEMA-4X	2,000,000	60	100 db at 10 ft
400207	AP275-705CID2	Class I, Division 2	2,000,000	60	100 db at 10 ft

*Factory set

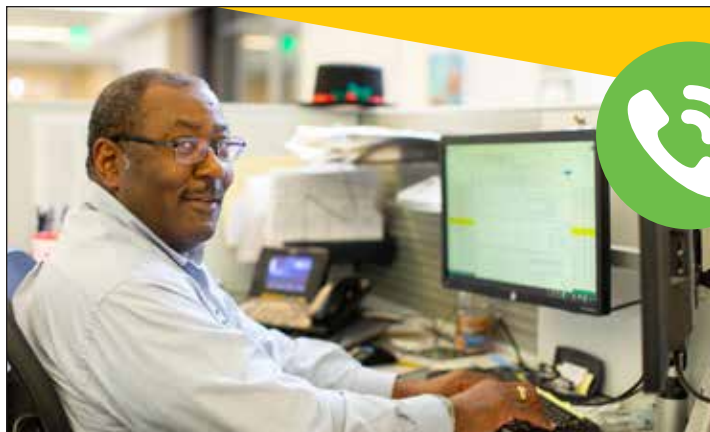

TALK TO AN EXPERT TODAY!

Need application advice or help to locate a part? Contact our technical specialists, they are here to help!

1-888-885-2673



Metal First Aid Cabinets

These Metal First Aid Cabinet are ideal for treating the small wounds and injuries that can happen at the workplace. Cabinets can be wall mounted at an easily accessible location or can be easily carried around using a built-in handle. These first aid kits meet OSHA standards.



C&M PART #	MFG PART #	DESCRIPTION
110603	6135	Metal First Aid Cabinet, 2-Shelf, 75 Person
110604	6155	Metal First Aid Cabinet, 3-Shelf, 100 Person
110605	6175	Metal First Aid Cabinet, 4-Shelf, 150 Person

Contractor First Aid Kits

Treat small wounds and injuries that happen at the work site with the Contractor First Aid Kits. The plastic case is weather resistant which is perfect for keeping the essential first aid supplies dry and free of moisture. The contractor first aid kits are OSHA compliant.



C&M PART #	MFG PART #	DESCRIPTION
110611	9300-10P	10 Person First Aid Kit, 95 Pieces
110609	9301-25P	25 Person First Aid Kit, 178 Pieces
110607	9303-50P	50 Person First Aid Kit, 237 Pieces

First Responder Kits



110617



110618

The First Responder Emergency Response Bags are filled with the essential first aid supplies needed when responding to any medical emergency. Stay in OSHA compliance and be ready to administer on-site first aid with this emergency response bag. Durable 100 denier cordura bags feature a handle and shoulder strap for easy transport.

C&M PART #	MFG PART #	DESCRIPTION
110617	510-FR	First Responder Kit, Medium, 102 Pieces
110618	520-FR	First Responder Kit, Large, 158 Pieces

Class A & B First Aid Kits and Cabinets



110590

110602

110594

110579

110597

110582

110600

Class A & B First Aid Kits and Cabinets follow ANSI Z308.1-2021 standards. Class A kits and cabinets are best used for common workplace injuries, while Class B kits and cabinets are best used for injuries in high-risk environments. All cabinets are made from durable metal and feature a handle for easy transport. Class A+ & Class B+ include extra components beyond the ANSI Z308.1-2021 standards.

CERTIFICATIONS

- ANSI Z308.1-2021

C&M PART #	MFG PART #	DESCRIPTION
CLASS A KITS & CABINETS		
110590	91323	Metal First Aid Kit, Class A, 10 Person
110587	91325	Metal First Aid Kit, Class A, 25 Person
110585	91328	Metal First Aid Kit, Class A, 50 Person
110589	91322	Plastic First Aid Kit, Class A, 10 Person
110586	91324	Plastic First Aid Kit, Class A, 25 Person
110584	91327	Plastic First Aid Kit, Class A, 50 Person
110602	90672	Metal First Aid Kit, Class A+, 25 Person
110577	91337	First Aid Cabinet, 2-Shelf, Class A, 75 Person
110579	91339	First Aid Cabinet, 3-Shelf, Class A, 100 Person
110597	90572	First Aid Cabinet, 2-Shelf, Class A+, 75+ Person
CLASS B KITS & CABINETS		
110594	91351	Metal First Aid Kit, Class B, 50 Person
110578	91338	First Aid Cabinet, 2-Shelf, Class B, 75 Person
110580	91340	First Aid Cabinet, 3-Shelf, Class B, 100 Person
110581	91341	First Aid Cabinet, 4-Shelf, Class B, 150 Person
110582	91342	First Aid Cabinet, 5-Shelf, Class B, 200 Person
110598	90575	First Aid Cabinet, 3-Shelf, Class B+, 100+ Person
110600	90576	First Aid Cabinet, 4-Shelf, Class B+, 150+ Person
110601	90577	First Aid Cabinet, 5-Shelf, Class B+, 200+ Person

Acme United 100 Person ANSI 2021 Class B, 3 Shelf Refill Kit

Stay ANSI and OSHA compliant at your manufacturing facility, warehouse and industrial site with this ANSI B Refill Kit. The 687-piece kit includes essential first aid supplies and over-the-counter medication for treating injuries occurring in more complex or high-risk work environments. The contents will refill a 3-shelf cabinet sufficient to support 100 people.



CERTIFICATIONS

- ANSI 2021 Class B

C&M PART #	MFG PART #	DESCRIPTION
110583	91361	Person ANSI 2021 Class B, 3 Shelf Refill Kit

Specialty First Aid Treatment Packs



First Aid Treatment Packs are essential in providing immediate care for minor injuries and medical emergencies. These packs typically contain a variety of supplies such as bandages, adhesive tape, antiseptic wipes, gauze pads, scissors, tweezers and disposable gloves. Designed to be portable, they come in a convenient bag, allowing you to quickly respond to injuries and provide basic medical assistance.

FEATURES & BENEFITS

- Grab-and-Go treatment bag stands on its own and easy to carry to an emergency
- Each first aid item's intended use is printed on the back of the bag

C&M PART #	MFG PART #	DESCRIPTION
110621	91164	Wound Care Treatment Pack
110622	91165	CPR & Sprains Treatment Pack
110623	91166	Bleeding Control Treatment Pack
110624	91167	Burn Care Treatment Pack
110625	91168	Eye Care Treatment Pack
110626	91169	Bloodborne Pathogen Treatment Pack

Glove Box Holder



These PPE glove box holders are made of high-quality clear acrylic so you can easily see what type of gloves are in the dispenser. Easily wall mount using the pre-drilled holes. Made in the USA.

C&M PART #	MFG PART #	DESCRIPTION	DIMENSIONS (H x W x D)
10883939SEWY	AGBS	Single	5" x 10.5" x 4"
10883939SEYI	AGBD	Double	10" x 10.5" x 4"
10883939SEYU	AGBT	Triple	15" x 10.5" x 4"

Microflex® SafeGrip® Extended Cuff Disposable Latex Gloves

Ideal for heavy-duty jobs, these latex Microflex® SafeGrip® Gloves are three times thicker than standard latex gloves to resist rips, snags and tears. Soft, elastic fit and feel yet offer tough hand protection you can rely on.



MICROFLEX®

FEATURES & BENEFITS

- Textured fingertips provide secure grip
- Extended cuff for expanded protection over the wrist and forearm
- Double chlorinated for easy donning and a comfortable feel

SPECIFICATIONS

MATERIAL	Natural Rubber Latex
POWDER CONTENT	Powder Free
PALM THICKNESS	0.28 mm/11 mil
LENGTH	29.5 cm/11.6"

CERTIFICATIONS

- NFPA 1999

C&M PART #	MFG PART #	SIZE	COUNT/BOX
705713SM	SG-375-S	S	50
705713MD	SG-375-M	M	50
705713LG	SG-375-L	L	50
705713XL	SG-375-XL	XL	50

Microflex® Diamond Grip® Disposable Latex Gloves

Microflex® Diamond Grip® Gloves protect hands in the most demanding environments. These tough, durable disposable latex gloves are uniquely designed to be extra thick at the fingers (7.9 mil) for added protection against rips, snags and tears, where you need it most. Textured fingertips provide a secure, confident grip when handling slippery and oily objects.



MICROFLEX®

FEATURES & BENEFITS

- Extra thickness at the fingertips offers superior durability
- Textured fingertips for a better grip
- Double chlorinated for easy donning and a comfortable feel
- Excellent protection for water testing and analysis applications

SPECIFICATIONS

MATERIAL	Natural Rubber Latex
POWDER CONTENT	Powder Free
PALM THICKNESS	0.16 mm/6.3 mil
LENGTH	24.5 cm/9.6"

C&M PART #	MFG PART #	SIZE	COUNT/BOX
705715SM	MF-300-S	S	100
705715MD	MF-300-M	M	100
705715LG	MF-300-L	L	100
705715XL	MF-300-XL	XL	100

Microflex® Diamond Grip® Plus Disposable Latex Gloves

Microflex® Diamond Grip® Plus is a durable latex glove that is fully textured for a secure grip.



MICROFLEX®

FEATURES & BENEFITS

- Thick design for durable protection
- Fully textured for enhanced grip

SPECIFICATIONS

MATERIAL	Natural Rubber Latex
POWDER CONTENT	Powder Free
PALM THICKNESS	0.13 mm/5.1 mil
LENGTH	24.5 cm/9.6"

C&M PART #	MFG PART #	SIZE	COUNT/BOX
705716SM	DGP-350-S	S	100
705716MD	DGP-350-M	M	100
705716LG	DGP-350-L	L	100
705716XL	DGP-350-XL	XL	100

Microflex® Ultra One® Extended-Cuff Disposable Latex Gloves

Microflex® Ultra One® Gloves are strong, durable and feature an extended cuff for expanded protection over the wrist and forearm. Thick design offers added strength and durability.



MICROFLEX®

FEATURES & BENEFITS

- Extended cuff for expanded protection over the wrist and forearm
- Thick design for added strength and durability
- Comfortable latex material for soft, elastic fit and feel

SPECIFICATIONS

MATERIAL	Natural Rubber Latex
POWDER CONTENT	Powder Free
PALM THICKNESS	0.25 mm/9.8 mil
LENGTH	30 cm/11.8"

CERTIFICATIONS

- NFPA 1999

C&M PART #	MFG PART #	SIZE	COUNT/BOX
705714SM	UL-315-S	S	50
705714MD	UL-315-M	M	50
705714LG	UL-315-L	L	50
705714XL	UL-315-XL	XL	50

Microflex® ComfortGrip® Disposable Latex Gloves

Microflex ComfortGrip offer durable hand protection at an affordable price. Gloves measure 5-mil thick at the palm and 6.3-mil thick at the fingertips. Fully textured surface allows a secure grip on a variety of materials.



MICROFLEX®

FEATURES & BENEFITS

- Economical yet reliable latex gloves
- Fully textured surface offers a secure grip

SPECIFICATIONS

MATERIAL	Natural Rubber Latex
POWDER CONTENT	Powder Free
PALM THICKNESS	0.13 mm/5.1 mil
LENGTH	24.5 cm/9.6"

C&M PART #	MFG PART #	SIZE	COUNT/BOX
705717SM	CFG-900-S	S	100
705717MD	CFG-900-M	M	100
705717LG	CFG-900-L	L	100
705717XL	CFG-900-XL	XL	100



Microflex® Black Dragon® Disposable Latex Gloves

Microflex Black Dragon BD-100L Latex Gloves mask dirt and provide a contrast against tools and materials. Fully textured surface provides secure grip on a wide variety of materials.



MICROFLEX®

FEATURES & BENEFITS

- Unique dark color assists in framing and focus
- Versatile latex for multiple applications

SPECIFICATIONS

MATERIAL	Natural Rubber Latex
POWDER CONTENT	Powder Free
PALM THICKNESS	0.14 mm/5.5 mil
LENGTH	24.5 cm/9.6"

C&M PART #	MFG PART #	SIZE	COUNT/BOX
705718SM	BD-1001-PF	S	100
705718MD	BD-1002-PF	M	100
705718LG	BD-1003-PF	L	100
705718XL	BD-1004-PF	XL	100

Microflex® MidKnight® Disposable Nitrile Gloves

Microflex MidKnight Nitrile Gloves offer tough protection while masking dirt, oils and grease so wearers' hands look neat and professional during work. The dark color makes it easier to see lighter materials they handle. Fully textured and nonfoaming design offers secure grip in dry and wet environments.



MICROFLEX®

FEATURES & BENEFITS

- Black gloves hide stains and offer contrast for improved visibility
- Fully textured design for a confident grip
- Nonfoaming for easy handling of objects even in wet environments

SPECIFICATIONS

MATERIAL	Nitrile
POWDER CONTENT	Powder Free
PALM THICKNESS	0.12 mm/4.7 mil
LENGTH	24.5 cm/9.6"

C&M PART #	MFG PART #	SIZE	COUNT/BOX
705725SM	MK-296-S	S	100
705725MD	MK-296-M	M	100
705725LG	MK-296-L	L	100
705725XL	MK-296-XL	XL	100
7057252X	MK-296-XXL	2XL	100

Microflex® 93-260 Chemical-Resistant Disposable Gloves

Microflex 93-260 Chemical-Resistant Gloves feature an innovative three-layer design that withstand a wide range of aggressive chemicals. The exterior nitrile layer delivers maximum protection against several organic solvents, while the soft neoprene middle layer provides acid and base resistance. A final interior layer provides a continual dry feel, while easing the donning and doffing process.



MICROFLEX®

FEATURES & BENEFITS

- Three-layer design for superior protection against harsh chemicals
- The thinnest chemical resistant disposable glove for enhanced dexterity and flexibility
- Extra soft material and ergonomic design for outstanding fit, feel and flexibility
- Lower acceptable pinhole rate (0.65 AQL) for reliable protection against hazardous substances

SPECIFICATIONS

MATERIAL	Nitrile (NBR) Rubber & Neoprene
POWDER CONTENT	Powder Free
PALM THICKNESS	0.198 mm/7.9 mil
LENGTH	28.5 cm/11.2"

C&M PART #	MFG PART #	SIZE	COUNT/BOX
705731SM	93260070	S	50
705731MD	93260080	M	50
705731LG	93260090	L	50
705731XL	93260100	XL	50
7057312X	93260110	2XL	50

QUANTITY PRICE BREAKS AVAILABLE

Call us or visit our product pages for details

1-888-885-2673



Microflex® Aloe Sense™ Disposable Nitrile Gloves

Microflex Aloe Sense N96 is designed with proprietary aloe and chamomile inner coating. The soft nitrile formulation provides a comfortable fit and feel for extended wear. Textured fingers provide a more secure grip of instruments.



MICROFLEX®

FEATURES & BENEFITS

- Proprietary aloe and chamomile inner coating
- Manufactured with a robust profile for added durability and chemical splash resistance

SPECIFICATIONS

MATERIAL	Nitrile
POWDER CONTENT	Powder Free
PALM THICKNESS	0.09 mm/3.5 mil
LENGTH	25 cm/9.8"

C&M PART #	MFG PART #	SIZE	COUNT/BOX
705734XS	N960	XS	100
705734SM	N961	S	100
705734MD	N962	M	100
705734LG	N963	L	100
705734XL	N965	XL	100

Microflex® Dura Flock® Flock-Lined Disposable Nitrile Gloves

Extra thick, durable Microflex® Dura Flock® Gloves offer excellent protection for demanding jobs. Super-thin, soft flock lining absorbs moisture to keep hands dry and comfortable during extended wear.



MICROFLEX®

FEATURES & BENEFITS

- Soft, flock lining absorbs moisture
- Thick design resists punctures and tears
- Durable nitrile for reliable splash protection

SPECIFICATIONS

MATERIAL	Nitrile
POWDER CONTENT	Powder Free
PALM THICKNESS (mil)	0.22 mm/8.7 mil
LENGTH	27 cm/10.6"

C&M PART #	MFG PART #	SIZE	COUNT/BOX
705720SM	DFK-608-S	S	50
705720MD	DFK-608-M	M	50
705720LG	DFK-608-L	L	50
705720XL	DFK-608-XL	XL	50
7057202X	DFK-608-XXL	2XL	50

Microflex® NeoPro® Disposable Gloves

With its durable design, textured fingers and neoprene formulation, Microflex® NeoPro® EC Gloves offer exceptional grip in both wet and dry environments. The gloves provide excellent protection against splashes from a wide range of chemicals.



MICROFLEX®

FEATURES & BENEFITS

- Excellent splash protection against a wide range of chemicals.
- Polymer coated for easy donning.
- Latex free—great for people with latex allergies

SPECIFICATIONS

MATERIAL	Neoprene Rubber
POWDER CONTENT	Powder Free
PALM THICKNESS	0.16 mm/6.3 mil
LENGTH	29 cm/11.4"

CERTIFICATIONS

- NFPA 1999

C&M PART #	MFG PART #	SIZE	COUNT/BOX
705737SM	NEC-288-S	S	50
705737MD	NEC-288-M	M	50
705737LG	NEC-288-L	L	50
705737XL	NEC-288-XL	XL	50

Microflex® Vinyl Disposable Gloves

Microflex Vinyl Gloves are great for general-purpose light-duty applications. Gloves have a smooth finish for a more natural fit.



MICROFLEX®

FEATURES & BENEFITS

- Extremely thin gloves offer great dexterity and flexibility
- Produced without the use of DEHP

SPECIFICATIONS

MATERIAL	Vinyl
POWDER CONTENT	Powder Free
PALM THICKNESS	0.07 mm/2.8 mil
LENGTH	24 cm/9.5"

C&M PART #	MFG PART #	SIZE	COUNT/BOX
705733SM	V281	S	100
705733MD	V282	M	100
705733LG	V283	L	100
705733XL	V284	XL	100



Microflex® Supreno® SE Disposable Nitrile Gloves

Microflex Supreno SE combine sturdy nitrile construction with low AQL to offer excellent chemical splash protection and exceptional barrier integrity. Textured fingertips provide a secure grip—excellent for oily or wet environments.



MICROFLEX

FEATURES & BENEFITS

- Durable nitrile formulation for demanding jobs
- Sturdy design for longer wear times
- Exceptional barrier integrity with 0.65 AQL for allowable pinholes
- Textured fingertips provide secure grip

SPECIFICATIONS

MATERIAL	Nitrile
POWDER CONTENT	Powder Free
PALM THICKNESS	0.11 mm/4.3 mil
LENGTH	24.5 cm/9.6"

C&M PART #	MFG PART #	SIZE	COUNT/BOX
705724SM	SU-690-S	S	100
705724MD	SU-690-M	M	100
705724LG	SU-690-L	L	100
705724XL	SU-690-XL	XL	100

Microflex® Supreno® EC Disposable Nitrile Gloves

Microflex Supreno EC Gloves are renowned for the comfort and durability they provide. These disposable gloves combine sturdy nitrile construction with low AQL to offer excellent chemical splash protection and exceptional barrier integrity. Extended cuff provides extra protection over the wrist and forearm.



MICROFLEX

FEATURES & BENEFITS

- Superior strength and durability for maximum protection against rips, snags or tears
- Low, 0.65 AQL for advanced barrier protection
- Ideal for raw material sample collection

Microflex® Blaze® Disposable Nitrile Gloves

Microflex Blaze Gloves are made of robust, highly visible orange nitrile material that protects hands in demanding environments. Textured fingertips provide a secure grip even in oily environments.



MICROFLEX

FEATURES & BENEFITS

- Highly visible orange color
- Works exceptionally well in oily environments
- Extended cuff for added protection of wrist and forearm

SPECIFICATIONS

MATERIAL	Nitrile
POWDER CONTENT	Powder Free
PALM THICKNESS	0.13 mm/5.1 mil
LENGTH	27 cm/10.6"

CERTIFICATIONS

- NFPA

C&M PART #	MFG PART #	SIZE	COUNT/BOX
705722SM	N481	S	100
705722MD	N482	M	100
705722LG	N483	L	100
705722XL	N484	XL	100
7057222X	N485	2XL	100

SPECIFICATIONS

MATERIAL	Nitrile
POWDER CONTENT	Powder Free
PALM THICKNESS	0.14 mm/5.5 mil
LENGTH	29.5 cm/11.6"

CERTIFICATIONS

- NFPA 1999

C&M PART #	MFG PART #	SIZE	COUNT/BOX
70572ISM	SEC-375-S	S	50
70572IMD	SEC-375-M	M	50
70572ILG	SEC-375-L	L	50
70572IXL	SEC-375-XL	XL	50
70572I2X	SEC-375-XXL	2XL	50
70572I3X	SEC-375-XXXL	3XL	50

Microflex® Integra® Extended-Cuff Disposable Nitrile Gloves

Microflex Integra nitrile gloves are extra thick in the palm and finger to provide added durability. Extended length offers expanded protection over the wrist and forearm.



MICROFLEX®

FEATURES & BENEFITS

- Enhanced thickness in the palm and finger for durable protection
- Extended length provides superior protection in high-risk conditions
- Excellent alternative for people with latex allergies

SPECIFICATIONS

MATERIAL	Nitrile
POWDER CONTENT	Powder Free
PALM THICKNESS:	0.20 mm/7.9 mil
LENGTH	29.5 cm/11.6"

C&M PART #	MFG PART #	SIZE	COUNT/BOX
705719SM	N871	S	50
705719MD	N872	M	50
705719LG	N873	L	50
705719XL	N874	XL	50
7057192X	N875	2XL	50

Microflex® Integra® Disposable Nitrile Gloves

Extra thickness in the palm and finger gives the Microflex Integra Gloves the added robustness and durability.



MICROFLEX®

FEATURES & BENEFITS

- Enhanced thickness in the palm and finger for added durability
- Great alternative to people with latex allergies

SPECIFICATIONS

MATERIAL	Nitrile
POWDER CONTENT	Powder Free
PALM THICKNESS (mil)	0.17 mm/6.7 mil
LENGTH	24 cm/9.5"

CERTIFICATIONS

- NFPA

C&M PART #	MFG PART #	SIZE	COUNT/BOX
705723SM	N861	S	50
705723MD	N862	M	50
705723LG	N863	L	50
705723XL	N864	XL	50
7057232X	N865	2XL	50

Microflex® UltraSense® Disposable Nitrile Gloves

Microflex UltraSense Gloves are made from thin, yet durable nitrile formulation, providing reliable protection along with tactility. The unique royal blue color offers greater contrast and visibility than standard light blue gloves.



MICROFLEX®

FEATURES & BENEFITS

- Thin, yet durable nitrile formulation offers dependable protection
- Royal blue color provides excellent contrast
- Nonstick exterior prevents tapes and adhesives from sticking

SPECIFICATIONS

MATERIAL	Nitrile
POWDER CONTENT	Powder Free
PALM THICKNESS	0.08 mm/3.1 mil
LENGTH	24 cm/9.5"

C&M PART #	MFG PART #	SIZE	COUNT/BOX
705728SM	US-220-S	S	100
705728MD	US-220-M	M	100
705728LG	US-220-L	L	100
705728XL	US-220-XL	XL	100

Microflex® UltraSense® Extended-Cuff Disposable Nitrile Gloves

Due to its soft, thin and flexible formulation, Microflex® UltraSense® EC provides impressive tactile sensitivity for light to mid-duty work. Extended cuff offers expanded protection over the wrist and forearm.



MICROFLEX®

FEATURES & BENEFITS

- Extended cuff for expanded protection over the wrist and forearm
- Nonstick surface resists tapes and adhesives
- Textured fingertips for enhanced grip
- 100 gloves per box—get more per box than most extended cuff gloves

SPECIFICATIONS

MATERIAL	Nitrile
POWDER CONTENT	Powder Free
PALM THICKNESS	0.10 mm/3.9 mil
LENGTH	29 cm/11.4"

C&M PART #	MFG PART #	SIZE	COUNT/BOX
705727SM	USE-880-S	S	100
705727MD	USE-880-M	M	100
705727LG	USE-880-L	L	100
705727XL	USE-880-XL	XL	100
7057272X	USE-880-XXL	2XL	100



Microflex® Ultraform® Disposable Nitrile Gloves

Microflex Ultraform Gloves protect hands while offering exceptional dexterity for jobs requiring fine motor control. Designed with ERGOFORM™ ergonomic design technology, these thin, tactile gloves reduce the amount of muscle effort wearers exert while performing repetitive tasks. The soft nitrile formulation forms to hands for a comfortable fit and feel during extended wear.



MICROFLEX®

FEATURES & BENEFITS

- Made with ERGOFORM™ design technology to support musculoskeletal health
- Textura thin design for superior tactile sensitivity
- Soft nitrile gloves are comfortable even during extended wear
- Packaged 300 per dispenser to reduce waste

SPECIFICATIONS

MATERIAL	Nitrile
POWDER CONTENT	Powder Free
PALM THICKNESS	0.06 mm/2.4 mil
LENGTH	23 cm/9.1"

C&M PART #	MFG PART #	SIZE	COUNT/BOX
705730SM	UF-524-S	S	300
705730MD	UF-524-M	M	300
705730LG	UF-524-L	L	300
705730XL	UF-524-XL	XL	300

Microflex® XCEED® Disposable Nitrile Gloves

Microflex XCEED disposable gloves offer superior protection and exceptional dexterity. Designed with ERGOFORM™ ergonomic design technology, these thin, tactile gloves reduce the amount of muscle effort wearers exert while performing repetitive tasks. The thin-mil design provides enhanced tactile sensitivity while protecting hands.



MICROFLEX®

FEATURES & BENEFITS

- Made with ERGOFORM™ design technology to support musculoskeletal health
- Low 0.65 AQL offers exceptional barrier integrity
- Strong nitrile formulation prevents against rips and tears
- Smartly packaged 250 gloves per box with easy, single glove dispenser help reduce waste

SPECIFICATIONS

MATERIAL	Nitrile
POWDER CONTENT	Powder Free
PALM THICKNESS	0.07 mm/2.8 mil
LENGTH	24 cm/9.5"

C&M PART #	MFG PART #	SIZE	COUNT/BOX
705729SM	XC-310-S	S	250
705729MD	XC-310-M	M	250
705729LG	XC-310-L	L	250
705729XL	XC-310-XL	XL	250

Microflex® FreeForm® Disposable Nitrile Gloves

Microflex® FreeForm® Nitrile Glove have nonstick properties that resist tape and adhesives. Textured fingertips offer a secure grip. Perfect gloves when performing light to mid-duty work.



MICROFLEX®

FEATURES & BENEFITS

- Nonstick properties resist tape and adhesives
- Textured fingertips for enhanced grip
- Excellent alternative for people with latex allergies

SPECIFICATIONS

MATERIAL	Nitrile
POWDER CONTENT	Powder Free
PALM THICKNESS (MIL)	0.12 mm/4.7 mil
LENGTH	24.5 cm/9.6"

CERTIFICATIONS

- NFPA 1999

C&M PART #	MFG PART #	SIZE	COUNT/BOX
705726SM	FFS-700-S	S	100
705726MD	FFS-700-M	M	100
705726LG	FFS-700-L	L	100
705726XL	FFS-700-XL	XL	100

Thickster™ Latex Exam Grade Disposable Gloves

The Thickster Latex Exam Grade Disposable Gloves measure 14-mil thick offering excellent tear resistance. These extra thick and tough gloves feature a textured grip with a beaded cuff and are 12" long for added arm protection. Use these gloves for chemicals, janitorial, automotive, painting and plumbing applications.



FEATURES & BENEFITS

- Beaded cuff for easy wearing
- 12" L gloves offer additional arm protection
- 14-mil thick yet soft and flexible
- Single use only

SPECIFICATIONS

MATERIAL	Latex
POWDER CONTENT	Powdered
THICKNESS	14 mil

C&M PART #	MFG PART #	SIZE	QUANTITY/BOX
102264MD	6602-20	M	50
102264LG	6603-20	L	50
102264XL	6604-20	XL	50
1022642X	6605-20	2X	50



Helpful Tip: Choose the Right Fit

Not only is it important to select the right glove for the job, but it should fit your hand.

1. Measure the circumference of your hand along the knuckles
2. Use that measurement to find your glove size in the chart

HAND SIZE	(in)	6-7	7-8	8-9	9-10	10-11	11-12	12-13
	(cm)	15.2-17.8	17.8-20	20-23	23-25	25-28	28-30.5	30.5-33
U.S. GLOVE SIZE		X-Small	Small	Medium	Large	X-Large	2X-Large	3X-Large
EUROPEAN GLOVE SIZE		6	7	8	9	10	11	12

Raven Powder-Free Nitrile Exam Grade Disposable Gloves

The Raven Powder-Free Nitrile Exam Grade Disposable Gloves offer superior puncture and abrasion resistance while providing outstanding strength, wear and dexterity. They are textured for enhanced gripping power and pass ASTM D6978 standards. Ideal for chemicals, janitorial, automotive, painting and plumbing applications.



FEATURES & BENEFITS

- Black color hides dirt
- Non-latex—great alternative for people with latex allergies
- Single use only

SPECIFICATIONS

MATERIAL	Nitrile
POWDER CONTENT	Powder Free
THICKNESS	7 mil

CERTIFICATIONS

- ASTM D6978 Standards

C&M PART #	MFG PART #	SIZE	QUANTITY/BOX
102250SM	66516	S	100
102250MD	66517	M	100
102250LG	66518	L	100
102250XL	66519	XL	100
1022502X	66520	2X	100

Astro-Grip® Powder-Free Nitrile Exam Grade Disposable Gloves

The Astro-Grip Powder-Free Nitrile Exam Grade Disposable Gloves feature a dual-sided scale textured surface for superior grip. These gloves provide effective chemical and puncture resistance, making them ideal for chemical, janitorial, automotive, painting and plumbing applications.



FEATURES & BENEFITS

- Highly visible orange color
- Non-latex—great alternative for people with latex allergies
- Single use only

SPECIFICATIONS

MATERIAL	Nitrile
POWDER CONTENT	Powder Free
THICKNESS	8 mil

C&M PART #	MFG PART #	SIZE	QUANTITY/BOX
102255MD	66572	M	100
102255LG	66573	L	100
102255XL	66574	XL	100



Radians® Crinkle Latex Palm-Coated Gloves

The Crinkle Latex Palm-Coated Gloves feature 10-gauge light blue polyester shell with blue latex palm coating. The breathable polyester shell and seamless elastic cuff provide a comfortable, slip-on fit. The crinkly latex palm coating provides extra grip, durability and excellent abrasion resistance. Sold as a pair.



FEATURES & BENEFITS

- Tested to EN388 standards for abrasion, cuts, tear and puncture (2 1 4 2 X)
- Lightweight gloves provide comfort for all day wear
- Latex coating provides protection from abrasion in wet or dry conditions

SPECIFICATIONS

MATERIAL	10-Gauge Polyester Shell
PALM	Crinkle Latex
CUFF STYLE	Seamless Comfort Cuff

CERTIFICATIONS

- EN388:2003 Standards

C&M PART #	MFG PART #	SIZE
100518MD	RWG16M	M
100518LG	RWG16L	L
100518XL	RWG16XL	XL

Radians® FDG® Coated Full-Dipped Waterproof Nitrile Work Gloves

The Full-Dipped Waterproof Nitrile Gloves have FDG palm coating that provides excellent grip in wet/oily conditions.

Gloves feature a 13-ga nylon shell with fully dipped nitrile coating that is waterproof to wrist and provide high abrasion resistance. Sold as a pair.



FEATURES & BENEFITS

- Tested to EN388:2016 standards for abrasion, cuts tear, puncture and ISO cut test (4131X)
- Waterproof nitrile coating
- Durable yet flexible grip

SPECIFICATIONS

MATERIAL	13-Gauge Nylon with Fully-Dipped Nitrile Coating
PALM	FDG
CUFF STYLE	Seamless Comfort Cuff

CERTIFICATIONS

- EN388:2016 Standards

C&M PART #	MFG PART #	SIZE
100523MD	RWG32M	M
100523LG	RWG32L	L
100523XL	RWG32XL	XL

PPE Dispensers



C&M PART #	MFG PART #	DESCRIPTION	MATERIAL
108836390ASE	AEP-4	Ear Plugs Dispenser, Small	Acrylic
108836390BSE	AEP-D	Ear Plugs Dispenser, Large	Acrylic
108842390ESE	AEP-3	Ear Plugs Tray Dispenser	Acrylic
108839390CSE	AGBS	Nitrile Gloves Dispenser, Single Box	Acrylic
108839390DSE	AGBD	Nitrile Gloves Dispenser, Double Box	Acrylic
108839390GSE	AGBT	Nitrile Gloves Dispenser, Triple Box	Acrylic
10883839SEYN	ACD	Bouffant Caps, Beard Covers, Shoe Covers Dispenser	Acrylic
108843390FSE	ASG-D	Visitor Safety Glasses Dispenser	Acrylic
108843390HSE	ASG-3	Safety Glasses Dispenser, Double Compartment	Acrylic
108843390ISE	ABM	Miscellaneous Covered Dispenser	Acrylic
10884668	ADT	Compact Dispenser, No Cover	Acrylic
10884669	ADTC	Compact Covered Dispenser	Acrylic

Use these dispensers to easily dispense PPE for visitors and employees. These sturdy acrylic dispensers keep PPE items organized and are labeled to the specific dispensed items. Place on benchtop or wall mount (except the compact dispensers) to keep benchtop clear.



Radians® PU Palm-Coated Gloves

The Polyurethane (PU) palm-coated gloves with a 13-gauge gray polyester shell are lightweight and comfortable to wear. The seamless elastic cuff provides a comfortable, slip-on fit while the PU palm coating provides excellent protection in wet or dry applications, reducing hand fatigue. Sold as a pair.



FEATURES & BENEFITS

- Tested to EN388:2015 standards for abrasion, cuts, tear and puncture (4 1 3 1)
- Breathable polyester shell provide comfort for all-day wear
- Lightweight and offers excellent dexterity

SPECIFICATIONS

MATERIAL	13-Gauge Polyester Shell
PALM	Polyurethane
CUFF STYLE	Seamless Comfort Cuff

CERTIFICATIONS

- EN388:2015 Standards

C&M PART #	MFG PART #	SIZE
100603MD	RWG14M	M
100603LG	RWG14L	L
100603XL	RWG14XL	XL
1006032X	RWG142X	2X

Radians® Radwear Silver Series™ High-Visibility Knit Dipped Gloves

The Silver Series High-Visibility Gloves have a 15-gauge nylon shell. The elastic cuff provides a comfortable, slip-on fit while the micro-foam dipped latex palm provides durability and a slip-free grip. Sold as a pair.



FEATURES & BENEFITS

- Meets EN 388:2003 standards for abrasion, cuts, tear and puncture (2 1 3 1)
- Highly visible neon color—visible even during daytime
- Micro-foam coated latex palm offers a slip-free grip

SPECIFICATIONS

MATERIAL	13-Gauge Nylon Shell
PALM	Foam Latex
CUFF STYLE	Seamless Comfort Cuff

CERTIFICATIONS

- EN 388 Standards

C&M PART #	MFG PART #	SIZE
100425MD	RWG10M	M
100425LG	RWG10L	L
100425XL	RWG10XL	XL

Radians® AXIS™ Level A2 Cut Protection Foam Nitrile-Coated Gloves

The Axis Series RWG553 Gloves have an ANSI cut rating of A2 and an EN388 cut rating of 3 to provide significant protection against abrasion and cuts. The 18-gauge, high-performance polyethylene (HPPE) shell provides excellent cut resistance. It is often used in work environments with sharp objects, like HVAC, construction and manufacturing. Sold as a pair.



FEATURES & BENEFITS

- Tested to EN 388 standards for Abrasion Resistance, Blade Cut, Tear, and Puncture (4 3 4 1)
- HPPE offer superior cut resistance
- Foam nitrile palm coating provides protection from abrasion in wet or dry conditions
- Seamless cuff design provides a comfortable fit

SPECIFICATIONS

LOAD WEIGHT	785 g
MATERIAL	18-Gauge HPPE Shell
PALM	Sandy Foam Nitrile
CUFF STYLE	Seamless Comfort Cuff

CERTIFICATIONS

- ANSI Cut Level A2 and EN388 Cut Level 3

C&M PART #	MFG PART #	SIZE
100402MD	RWG533M	M
100402LG	RWG533L	L
100402XL	RWG533XL	XL
100402XXL	RWG5332X	2X

Radians® AXIS™ Level A4 Cut Protection High-Visibility Work Gloves

The Axis Series RWG564 Hi-Viz Work Gloves have an ANSI cut rating of A4. These gloves feature a high-performance polyethylene (HPPE) outer shell with fiberglass to provide significant protection against abrasion and cuts. The black foam nitrile palm coating provides excellent gripping power. Sold as a pair.



FEATURES & BENEFITS

- Tested to EN 388 standards for Abrasion Resistance, Blade Cut, Tear, and Puncture (4 5 4 4)
- Hi-viz HPPE shell is easily visible even at daytime
- Foam nitrile palm offer excellent abrasion protection in wet or dry applications

SPECIFICATIONS

LOAD WEIGHT	1510 g
MATERIAL	Hi-Viz HPPE Outer Shell with Fiberglass
PALM	Foam Nitrile
CUFF STYLE	Seamless Comfort Cuff

CERTIFICATIONS

- EN 388 Standards and ANSI Cut Level A4

C&M PART #	MFG PART #	SIZE
100695MD	RWG564M	M
100695LG	RWG564L	L
100695XL	RWG564XL	XL

Radians® AXIS™ Level A4 Cut Protection Work Gloves

The Axis Series RWG555 Level A4 Cut Protection Dipped Gloves provide excellent protection against abrasion, cuts, tear and puncture. The seamless design of the 13-gauge, high-performance polyethylene (HPPE) shell with fiberglass and foam nitrile dipped palm provides excellent protection and a comfortable fit in wet or dry applications. Sold as a pair.



FEATURES & BENEFITS

- Meets EN 388:2003 standards for Abrasion Resistance, Blade Cut, Tear, and Puncture (4 5 4 4)
- HHPE shell provides cut resistance
- Foam nitrile palm dip provides protection from abrasion in wet or dry conditions
- Seamless design provides a comfortable fit

SPECIFICATIONS

LOAD WEIGHT	1550 g
MATERIAL	HPPE Liner with Fiberglass
PALM	Foam Nitrile
CUFF STYLE	Seamless Comfort Cuff

CERTIFICATIONS

- EN 388 Standards, ANSI Cut Level A4 and EN388 Cut Level 5

C&M PART #	MFG PART #	SIZE
100249MD	RWG555M	M
100249LG	RWG555L	L
100249XL	RWG555XL	XL

Radians® AXIS™ Level A7 Cut Protection Sandy Nitrile Coated Gloves

The Axis Series RWG559 Gloves with an ANSI cut rating of A7 and an EN388 cut rating of 5 provide the ultimate cut protection. The 13-gauge, hi-viz orange high-performance polyethylene (HPPE) outer shell with fiberglass and stainless steel provides significant protection against abrasion and cuts. The black sandy nitrile palm coating provides excellent gripping power. Sold as a pair.



FEATURES & BENEFITS

- Tested to EN 388:2016 standards for Abrasion Resistance, Blade Cut, Tear, and Puncture (4 X 4 3 F)
- Hi-viz orange gloves are easy to see
- Seamless cuff design for a comfortable fit

SPECIFICATIONS

LOAD WEIGHT	4480 g
MATERIAL	HPPE Outer Shell with Stainless Steel & Fiberglass
PALM	Sandy Nitrile
CUFF STYLE	Seamless Comfort Cuff

CERTIFICATIONS

- EN 388:2016 Standards, ANSI Cut Level A7 and EN388 Cut Level 5

C&M PART #	MFG PART #	SIZE
100213SM	RWG559S	S
100213MD	RWG559M	M
100213LG	RWG559L	L
100213XL	RWG559XL	XL

Radians® AXIS™ Level A8 Cut Protection PU-Coated Gloves

The Axis Series RWG558 Gloves with ANSI cut rating of A8 and EN388 TDM-100 cut rating of F provide the utmost cut protection. The 13-gauge, hi-vis green high-performance polyethylene (HPPE) outer shell with fiberglass and stainless steel offers significant protection against abrasion and cuts. The black polyurethane (PU) palm coating provides excellent gripping power. Sold as a pair.



FEATURES & BENEFITS

- Tested to EN 388 standards for Abrasion Resistance, Blade Cut, Tear, Puncture, TDM-100 (4 X 4 3 F)
- Knitted HHPE outer shell with fiberglass and stainless steel for ultimate cut protection
- PU palm provides abrasion protection in wet or dry applications
- Seamless cuff design offers a comfortable fit

SPECIFICATIONS

LOAD WEIGHT	5045 g
MATERIAL	HPPE Outer Shell with Stainless Steel & Fiberglass
PALM	Polyurethane
CUFF STYLE	Seamless Comfort Cuff

CERTIFICATIONS

- EN 388:2016 Standards, ANSI Cut Level A8 and EN388 TDM-100 Cut Level F

C&M PART #	MFG PART #	SIZE
100219MD	RWG558M	M
100219LG	RWG558L	L
100219XL	RWG558XL	XL

Radians® AXIS D2™ Dyneema® Level A3 Cut Protection Gloves

The Axis D2™ RWGD101 Level A3 Cut Protection Gloves feature Dyneema Diamond Technology fibers that are thinner than generic high-modulus polyethylene (HMPE) fibers and less dense than aramid fibers, making them more comfortable and cooler to the touch, while still providing advanced cut protection. These gloves feature a 13-gauge white polyester shell with Dyneema Diamond Technology and a gray polyurethane (PU) palm coating to provide significant protection against abrasion and cuts.



Gloves have an ANSI cut rating of A3 and an EN388 cut rating of 5. Sold as a pair.

SPECIFICATIONS

LOAD WEIGHT	1072 g
MATERIAL	Dyneema Diamond Technology with Polyester
PALM	Polyurethane
CUFF STYLE	Seamless Comfort Cuff

CERTIFICATIONS

- ANSI Cut Level A3. Puncture Level 4 and Abrasion Level 1

C&M PART #	MFG PART #	SIZE
100429MD	RWGD101M	M
100429LG	RWGD101L	L
100429XL	RWGD101XL	XL

Radians® Level A5 Cut Protection Work Gloves

The RWG603R Cut Protection Gloves have an ANSI cut rating of A5 and an EN388 cut rating of 5. The high-visibility red sandy foam nitrile palm coating provides a strong grip in both wet and dry applications. The dense thermoplastic rubber (TPR) overlays on the back of the hand offer added impact protection. These 15-gauge high-performance polyethylene (HPPE) gloves are ideal for applications that need both cut and abrasion resistance along with the ability to grip objects. Sold as a pair.



FEATURES & BENEFITS

- Tested to EN 388 standards for abrasion resistance, blade cut, tear, and puncture (4 5 4 4)
- High Performance Polyethylene (HPPE) with fiberglass outer shell provides cut resistance
- Water-repellent treated shell
- Reinforced thumb crotch for durability

SPECIFICATIONS

LOAD WEIGHT	2837 g
MATERIAL	HPPE with Fiberglass Outer Shell
PALM	Foam Nitrile
CUFF STYLE	Seamless Comfort Cuff

CERTIFICATIONS

- EN 388:2016 Standards, ANSI Cut Level A5, EN388 Cut Level 5 and ANSI/ISEA 138 Impact Level 2

C&M PART #	MFG PART #	SIZE
100547MD	RWG603RM	M
100547LG	RWG603RL	L
100547XL	RWG603RXL	XL

Radians® Nylon Shell Foam Nitrile Gripper Gloves

The RWG13 Gloves have foam dipped nitrile palm with 15-gauge blended nylon/spandex shell. The elastic cuff provides a comfortable, slip-on fit while the foam dipped palm provides durability and a slip-free grip. An additional palm coating gives water resistance.



FEATURES & BENEFITS

- Meets EN 388:2003 standards for abrasion, cuts, tear, and puncture (4 1 3 1)
- Water repellent treated shell
- Seamless cuff offers comfortable, slip-on fit

SPECIFICATIONS

MATERIAL	Nylon/Spandex Shell
PALM	Foam Nitrile
CUFF STYLE	Seamless Comfort Cuff

CERTIFICATIONS

- EN 388:2003 Standards and ANSI/ISEA 105 Abrasion Level 6

C&M PART #	MFG PART #	SIZE
100300MD	RWG13M	M
100300LG	RWG13L	L
100300XL	RWG13XL	XL
1003002X	RWG13XXL	2X

Radians® Ghost™ Series Level A2 Cut Protection Work Gloves

The Ghost Series RWG5550 Gloves have an ANSI cut rating of 2 and an EN388 cut rating of 2. A 13-gauge, high-performance polyethylene (HPPE) shell with polyurethane coating provides a comfortable fit in hazardous applications. It is often used in work environments with sharp objects, like HVAC, construction and manufacturing. Sold as a pair.



FEATURES & BENEFITS

- Tested to EN 388:2016 Standards for Abrasion Resistance, Blade Cut, Tear, and Puncture (4 2 4 2)
- Polyurethane palm dip provides protection from abrasion in wet or dry conditions
- Seamless design provides a comfortable fit

SPECIFICATIONS

LOAD WEIGHT	548 g
MATERIAL	HPPE
PALM	Polyurethane
CUFF STYLE	Seamless Comfort Cuff

CERTIFICATIONS

- EN 388:2016 Standards, ANSI Cut Level A2, and EN388 Cut Level 2

C&M PART #	MFG PART #	SIZE
100382MD	RWG550M	M
100382LG	RWG550L	L
100382XL	RWG550XL	XL

Radians® KAMORI® Level A4 Cut Protection Work Gloves with TPR Overlays

The KAMORI RWG50 Cut Protection Work Glove have an ANSI cut rating of A4, ANSI/ISEA 138 impact level 1 and an EN388 cut rating of 5. The white grain goatskin glove with an Aramid lining provides excellent cut protection. The dense TPR overlays on the back of the hand provide added impact protection.



FEATURES & BENEFITS

- Tested to EN 388 standards for abrasion resistance, blade cut, tear and puncture (3 5 2 3)
- White grain goat skin driver with Aramid lining
- Slip-on cuff design provides a comfortable fit.
- TPR overlays provide added impact protection

SPECIFICATIONS

LOAD WEIGHT	2679 g
MATERIAL	White Grain Goat Skin with TPR and Kevlar®, Glass Fiber and Polyester Shell
LINING	Kevlar®, Glass Fiber, Steel and Polyester
CUFF STYLE	Slip-On

CERTIFICATIONS

- EN 388 Standards, ANSI Cut Level A4, EN388 Cut Level 5 and ANSI/ISEA 138 Impact Level 1

C&M PART #	MFG PART #	SIZE
100460MD	RWG50M	M
100460LG	RWG50L	L
100460XL	RWG50XL	XL

Radians® KAMORI® Level 4 Cut Protection Work Gloves

The KAMORI RWG52 Cut Protection Work Glove have an ANSI cut rating of A4 and an EN388 cut rating of 5. The white grain goatskin glove with an Aramid lining provides excellent cut protection.



FEATURES & BENEFITS

- Tested to EN 388 standards for abrasion resistance, blade cut, tear and puncture (3 5 2 3)
- White grain goat skin driver with Aramid lining
- Slip-on cuff design provides a comfortable fit.

SPECIFICATIONS

LOAD WEIGHT	2679 g
MATERIAL	White Grain Goat Skin with and Kevlar®, Glass Fiber and Polyester Shell
LINING	Kevlar, Glass Fiber, Steel and Polyester
CUFF STYLE	Slip-On

CERTIFICATIONS

- Tested to EN 388 standards for Abrasion Resistance, Blade Cut, Tear, and Puncture (3 5 2 3)
- ANSI Cut Level A4, EN388 Cut Level 5

C&M PART #	MFG PART #	SIZE
100329MD	RWG52M	M
100329LG	RWG52L	L
100329XL	RWG52XL	XL

Radians® TEKTYE™ Level A4 Reinforced Thumb Work Gloves

The Radians RWG705 TEKTYE Reinforced Thumb A4 Work Gloves have 13-gauge orange shell with foam nitrile palm coating. TEKTYE is an engineered yarn capable of meeting the ANSI Cut Level A4 without the use of fiberglass or stainless steel.



FEATURES & BENEFITS

- Tested to EN388:2016 standards for abrasion resistance, coup test/cut, tear, puncture, and ISO cut test (4X43D)
- Reinforced thumb crotch for durability
- Free of fiberglass or stainless Steel

SPECIFICATIONS

LOAD WEIGHT	1600 g
MATERIAL	TEKTYE (fiberglass and stainless steel free)
PALM	Nitrile
CUFF STYLE	Seamless Comfort Cuff

CERTIFICATIONS

- EN388: 2016 Standards and ANSI Cut Level A4

C&M PART #	MFG PART #	SIZE
100686MD	RWG705M	M
100686LG	RWG705L	L
100686XL	RWG705XL	XL

Radians® TEKTYE™ Level A4 Touchscreen Work Gloves

The RWG701 TEKTYE Level A4 Touchscreen Work Gloves feature 13-gauge black shell with a polyurethane (PU) palm coating. TEKTYE is an engineered yarn capable of meeting the ANSI cut Level A4 without the use of fiberglass or stainless steel. Sold as a pair.



FEATURES & BENEFITS

- Tested to EN388:2016 standards for abrasion Resistance, Coup Test/Cut, Tear, Puncture, and ISO Cut Test (4X43D)
- Works on touchscreen
- Free of fiberglass or stainless steel

SPECIFICATIONS

LOAD WEIGHT	1995 g
MATERIAL	TEKTYE (fiberglass and stainless steel free)
PALM	Polyurethane
CUFF STYLE	Seamless Comfort Cuff

CERTIFICATIONS

- EN388:2016 Standards and ANSI Cut Level A4

C&M PART #	MFG PART #	SIZE
100652MD	RWG701M	M
100652LG	RWG701L	L
100652XL	RWG701XL	XL



Radians® Leather Work Gloves

These Leather Work Gloves are economical yet durable. Leather driver gloves come in cowhide and pigskin varieties. Leather palm gloves are available as joint split and split cowhide leather. Sold as a pair.



FEATURES & BENEFITS

Leather Driver Gloves

- Keystone thumb
- Shirred wrist
- Cloth hem

Leather Palm Gloves

- Gunn cut w/wing thumb
- Leather knuckle strap
- Rubberized safety cuff

C&M PART #	MFG PART #	LEATHER TYPE	SIZE
LEATHER DRIVER GLOVES			
100597SM	RWG4220S	Standard Grain Cowhide Leather	S
100597MD	RWG4220M	Standard Grain Cowhide Leather	M
100597LG	RWG4220L	Standard Grain Cowhide Leather	L
100597XL	RWG4220XL	Standard Grain Cowhide Leather	XL
1005972X	RWG4220XXL	Standard Grain Cowhide Leather	2X
1005973X	RWG4220XXXL	Standard Grain Cowhide Leather	3X
100552SM	RWG4821S	Top Grain Pigskin Leather	S
100552MD	RWG4821M	Top Grain Pigskin Leather	M
100552LG	RWG4821L	Top Grain Pigskin Leather	L
100552XL	RWG4821XL	Top Grain Pigskin Leather	XL
LEATHER PALM GLOVES			
100495MD	RWG3200JPM	Joint Split Cowhide Leather	M
100495LG	RWG3200JPL	Joint Split Cowhide Leather	L
100495XL	RWG3200JPXL	Joint Split Cowhide Leather	XL
1004952X	RWG3200JPXXL	Joint Split Cowhide Leather	2X
100615SM	RWG3200S	Split Cowhide Leather	S
100615MD	RWG3200M	Split Cowhide Leather	M
100615LG	RWG3200L	Split Cowhide Leather	L
100615XL	RWG3200XL	Split Cowhide Leather	XL
1006152X	RWG3200XXL	Split Cowhide Leather	2X

DeWALT® Synthetic Leather Performance Gloves

Use these Synthetic Leather Performance Gloves protect your hands by absorbing and dissipating energy while using power tools and hand tools. Foam-padded palms cushion hands while synthetic leather fingertip overlays offer grip and abrasion resistance. Thumb saddle and double stitching provide extra strength and durability. The hook and loop wrist closure ensures a secure fit and helps keep out debris.



FEATURES & BENEFITS

- Synthetic leather fingertip overlays
- Hook and loop wrist closure
- Foam-padded palm
- Reinforced thumb saddle
- Terry cloth brow wipe

C&M PART #	MFG PART #	SIZE
100108MD	DPG201M	M
100108LG	DPG201L	L
100108XL	DPG201XL	XL

DeWALT® Performance Hybrid Gloves

Get the durability and a comfortable fit with the Performance Hybrid Gloves. Gloves feature a split cowhide leather palm with overlay for added durability; breathable spandex back offer a cool, comfortable fit.



FEATURES & BENEFITS

- Split cowhide leather palm overlays provide extra grip and durability
- Short slip-on cuff for easy on and off.
- Lightweight, breathable spandex back allows for a cool, comfortable fit
- Reinforced saddle overlay provides additional durability

C&M PART #	MFG PART #	SIZE
100079LG	DPG216L	L
100079XL	DPG216XL	XL

DeWALT® All-Purpose Synthetic Leather Gloves

The Synthetic Leather Gloves with reinforced padded palm absorbs and dissipates energy while using hand tools and power tools. Tough Thread™ double stitching of the palm provides excellent durability. Neoprene knuckle strap protects knuckle while offering a comfortable fit. The hook and loop wrist closure ensures a secure fit and helps keep out debris.

FEATURES & BENEFITS

- Breathable neoprene between fingers offers improved flexibility
- Reinforced fingertips provide longer wear
- Reinforced ToughGrip™ thumb saddle provides greater protection and toughness
- Terry cloth backhand for wiping sweat away from brow

C&M PART #	MFG PART #	SIZE
100668MD	DPG20M	M
100668LG	DPG20L	L
100668XL	DPG20XL	XL



Radians® Level A3 Cut Protection Dipped Winter Gripper Gloves

The RWG27 Cold Weather Gripper Gloves provide ANSI level A3 protection against cuts. The gloves feature a 7-gauge high visibility yellow polyester shell with blue crinkle latex coating plus an acrylic/polyester liner to provide extra protection and warmth.



FEATURES & BENEFITS

- Tested to EN388:2003 standards for abrasion, cuts, tear and puncture (1 2 3 1)
- 80% acrylic, 20% polyester inner liner keeps your hands warm
- Seamless elastic slip-on cuff
- High visibility yellow polyester shell

SPECIFICATIONS

MATERIAL	Nylon Shell
PALM	Crinkle Latex
LINING	Acrylic/Polyester
CUFF STYLE	Seamless Comfort Cuff

CERTIFICATIONS

- EN388:2003 Standards and ANSI Cut Level A3

C&M PART #	MFG PART #	SIZE
100660MD	RWG27M	M
100660LG	RWG27L	L
100660XL	RWG27XL	XL
1006602X	RWG27XXL	2X

Radians® Level A4 Cut Protection Cold Weather Gloves with TPR Overlay

The Cut Protection Level A4 Coated Cold Weather Gloves feature a 2 ply, 13-gauge blue and white high-performance polyethylene (HPPE) shell to provide excellent protection from cuts and abrasion, while the 7-gauge acrylic terry liner provides warmth in cold conditions. The black micro nitrile palm coating offers a strong grip in both wet and dry applications. The high-visibility TPR overlays on the back of the hand provides added impact protection.



FEATURES & BENEFITS

- Tested to EN388:2003 standards for abrasion, cuts, tear and puncture (4 5 4 4)
- High-performance polyethylene provides cut resistance
- Acrylic terry liner provides warmth in cold conditions
- TPR overlays provide added impact protection
- Seamless cuff design provides a comfortable fit

SPECIFICATIONS

LOAD WEIGHT	1785 g
MATERIAL	HPPE Shell
PALM	Nitrile
LINING	Terry
CUFF STYLE	Seamless Comfort Cuff

CERTIFICATIONS

- EN388:2003 Standards, ANSI Cut Level A4, EN388 Cut Level 5 and ANSI/ISEA 138 Impact Level 1

C&M PART #	MFG PART #	SIZE
100049MD	RWG604M	M
100049LG	RWG604L	L
100049XL	RWG604XL	XL
1000492X	RWG604XXL	2X

Radians® Level A4 Cut Protection Double-Dipped Cold Weather Gloves

The RWG605 Cold Weather Gloves provides EN388 level 5 protection and ANSI level 4 protection against cuts. A 13-gauge knitted high-performance polyethylene (HPPE) outer shell has a smooth blue latex coating plus a 7-gauge acrylic inner shell to provide extra protection from cold and comfort. A black foam latex coating on the palm offers excellent protection from abrasion in wet or dry, cold weather conditions.



FEATURES & BENEFITS

- Tested to EN388 standards for abrasion, cuts, tear and puncture (4 5 4 4)
- HPPE outer shell with a smooth blue latex coating, black foam latex coated palm and acrylic inner shell
- Seamless elastic slip-on cuff

SPECIFICATIONS

LOAD WEIGHT	1888 g
MATERIAL:	HPPE with Double-Dipped Latex Coating
PALM:	Foam Latex
LINING:	Acrylic
CUFF STYLE:	Seamless Comfort Cuff

CERTIFICATIONS

- EN388 Standard and ANSI/ISEA Cut Level A4

C&M PART #	MFG PART #	SIZE
100089MD	RWG605M	S
100089MD	RWG605M	M
100089LG	RWG605L	L
100089XL	RWG605XL	XL
1000892X	RWG605XXL	2X



Radians® Level A2 Cut Protection Dipped Waterproof Winter Gripper Gloves

The RWG28 Cold Weather Gripper Gloves provide ANSI level A2 protection against cuts. A 13-gauge gray nylon shell with a black sandy foam latex palm dip and an acrylic/polyester liner provide extra protection and warmth.



FEATURES & BENEFITS

- Tested to EN388 standards for abrasion, cuts, tear and puncture (2 2 3 2 X)
- 10-gauge acrylic liner helps keep your hands warm
- Seamless elastic slip-on cuff

SPECIFICATIONS

LOAD WEIGHT	736 g
MATERIAL:	Nylon Shell
PALM:	Sandy Latex
LINING:	Acrylic
CUFF STYLE:	Seamless Comfort Cuff

CERTIFICATIONS

- EN388:2016 Standards and ANSI Cut level A2

C&M PART #	MFG PART #	SIZE
100205MD	RWG28M	M
100205LG	RWG28L	L
100205XL	RWG28XL	XL
1002052X	RWG28XXL	2X

Radians® Latex Coated Cold Weather Gloves

The water-resistant RWG17 gloves provide EN388 level 3 protection against abrasion. These gloves feature a two-ply, 13-gauge high-visibility orange nylon outer shell with a seamless cuff to provide extra protection and comfort. The 3/4 dipped micro finish black latex coating offers excellent protection from abrasion in wet or dry, cold weather conditions.



FEATURES & BENEFITS

- Tested to EN388 standards for abrasion, cuts, tear and puncture (3 2 4 3)
- Two-ply, water-resistant, hi-vis orange nylon shell
- Seamless elastic slip-on cuff

SPECIFICATIONS

MATERIAL	Nylon Shell
PALM	Foam Latex
LINING	Acrylic Terry
CUFF STYLE	Seamless Comfort Cuff

CERTIFICATIONS

- EN388:2003 Standards

C&M PART #	MFG PART #	SIZE
100528MD	RWG17M	M
100528LG	RWG17L	L
100528XL	RWG17XL	XL

Radians® Snow Blower™ Insulated Double-Dipped PVC Gloves

The Bellingham Snow Blower Insulated Gloves features a durable, flexible, double-dipped PVC coating that stays flexible to -4°F. A soft acrylic fleece liner helps keep your hands warm; textured palm provides excellent grip. These durable gloves are ideal for farm and ranch work, industrial work and general lawn and garden tasks.



FEATURES & BENEFITS

- Durable double-dipped PVC coating stays flexible to -4°F
- Acrylic fleece liner is soft and helps keep hands warm
- Textured palm offers excellent grip

C&M PART #	MFG PART #	SIZE
100421MD	SB4601M	M
100421LG	SB4601L	L
100421XL	SB4601XL	XL

WE'D LIKE YOUR FEEDBACK

on our catalog and website



Send us your thoughts at support.supply@coreandmain.com

MSA V-Gard® Slotted Full-Brim Hard Hats with Fas-Trac® III Suspension



The V-Gard Helmets, with its distinctive trademark "V" design, are made with high-quality, wear-resistant materials. The polyethylene shell offers superior top impact protection. The Fas-Trac III ratchet suspension is easy to use and the most comfortable on the market. To use, simply turn knob counter-clockwise to open ratchet band to its maximum size then turn clockwise to tighten and fit. The full brim offers protection from the sun. Hats are slotted to accept accessories listed below.

INCLUDES

Hard hat and suspension

CERTIFICATIONS

- ANSI/ISEA Z89.1

C&M PART #	MFG PART #	COLOR
110169	475369	White
110170	475368	Blue
110171	475366	Yellow
110172	10021292	Hi-Viz Orange
110173	10061515	Hi-Viz Yellow-Green

REPLACEMENT PARTS & ACCESSORIES

C&M PART #	MFG PART #	DESCRIPTION
110179	10148708	Fas-Trac III Replacement Suspension, 4-Point Standard, Black
110184	10116627	HDPE Frame for Universal MSA Hats, without Debris Control
110185	10115836	Visor, Contoured, Clear PC, 8" x 17" x 0.04"
110187	10115840	Visor, Contoured, Clear PC, 8" x 17" x 0.06"
110186	10115842	Visor, Contoured, Green Tint PC, AF/AS, 8" x 17" x 0.06"
110188	10115855	Visor, Propionate, Clear, Molded, 8" x 17" x 0.098"
110189	10118417	Value Liner, Knit Cap, 12/Pack
110190	10118427	Flame-Resistant Supreme 2-Piece Liner
110191	GA90047	Chinstrap, V-Gard Universal 4-Point
110192	10171103	Chinstrap, 2-Point, 3/4" Nomex Webbing, Attaches to Shell, 5/Pack
110193	10098032	Sunshade Hard Hat Protector, Single, Breathable Bright Mesh, Yellow-Green
110194	10098031	Sunshade Hard Hat Protector, Single, Breathable Bright Mesh, Orange
110196	697410	Sun Shield, for V-Gard Hats Only, Gray
110198	696688	Hard Hat Sweatband, Terry Cloth, Gray, 10/Pack
110199	10190356	Helmet Mounted Hearing Protection, Low
110200	10190357	Helmet Mounted Hearing Protection, Medium
110201	10190358	Helmet Mounted Hearing Protection, High

MSA V-Gard® Slotted Cap-Style Hard Hats with Fas-Trac® III Suspension



The V-Gard Helmets, with its distinctive trademark "V" design, are made with high-quality, wear-resistant materials. The polyethylene shell offers superior top impact protection. The Fas-Trac III ratchet suspension is easy to use and the most comfortable on the market. To use, simply turn knob counter-clockwise to open ratchet band to its maximum size then turn clockwise to tighten and fit. Hats are slotted to accept accessories listed below.

INCLUDES

Hard hat and suspension

CERTIFICATIONS

- ANSI/ISEA Z89.1

C&M PART #	MFG PART #	COLOR
110174	475358	White
110175	475359	Blue
110176	475360	Yellow
110177	488146	Hi-Viz Orange
110178	10061512	Hi-Viz Yellow-Green

REPLACEMENT PARTS & ACCESSORIES

C&M PART #	MFG PART #	DESCRIPTION
110179	10148708	Fas-Trac III Replacement Suspension, 4-Point Standard, Black
110182	10187161	Accessory Frame for Caps, Universal
110183	10187162	Cap Frame, Universale w/ Out Debris Control
110184	10116627	HDPE Frame for Universal MSA Hats, without Debris Control
110185	10115836	Visor, Contoured, Clear PC, 8" x 17" x 0.04"
110187	10115840	Visor, Contoured, Clear PC, 8" x 17" x 0.06"
110186	10115842	Visor, Contoured, Green Tint PC, AF/AS, 8" x 17" x 0.06"
110188	10115855	Visor, Propionate, Clear, Molded, 8" x 17" x 0.098"
110189	10118417	Value Liner, Knit Cap, 12/Pack
110190	10118427	Flame-Resistant Supreme 2-Piece Liner
110191	GA90047	Chinstrap, V-Gard Universal 4-Point
110192	10171103	Chinstrap, 2-Point, 3/4" Nomex Webbing, Attaches to Shell, 5/Pack
110195	697290	Sun Shield, for V-Gard Caps Only
110199	10190356	Helmet Mounted Hearing Protection, Low
110200	10190357	Helmet Mounted Hearing Protection, Medium
110201	10190358	Helmet Mounted Hearing Protection, High



MSA V-Gard® 500 Vented Full-Brim Hard Hat with 4-Point Fas-Trac® III Suspension

The V-Gard Helmets, with its distinctive trademark "V" design, are made with high-quality, wear-resistant materials. The polyethylene shell offers superior top impact protection. Cooling vents allow great air circulation to keep you cool. Full brim provides additional protection from the sun and wet environments. The Fas-Trac III ratchet suspension is easy to use and the most comfortable on the market. To use, simply turn knob counter-clockwise to open ratchet band to its maximum size then turn clockwise to tighten and fit.



INCLUDES

Hard hat and suspension

CERTIFICATIONS

- NSI/ISEA Z89.1-2014 (Vented Class C)

C&M PART #	MFG PART #	COLOR
110181	10167911	White

REPLACEMENT PARTS & ACCESSORIES

C&M PART #	MFG PART #	DESCRIPTION
110179	10148708	Fas-Trac III Replacement Suspension, 4-Point Standard, Black
110189	10118417	Value Liner, Knit Cap, 12/Pack
110190	10118427	Flame-Resistant Supreme 2-Piece Liner
110195	697290	Sun Shield, for V-Gard Caps Only

MSA V-Gard® Helmet-Mounted Hearing Protection Earmuffs

Mount the hearing protection earmuffs to a slotted MSA helmet help safeguard your hearing. These helmet-mounted hearing protectors offer enhanced comfort and top-of-the-line performance. Improved sealing ring and adapters lessen the pressure on the ears for all-day comfort while foam-injected ear pads cushion the outer ears for soft point of contact.



INCLUDES

Earmuff Only

CERTIFICATIONS

- ANSI S3.19-1974 (Low, Medium, High)

C&M PART #	MFG PART #	ATTENUATION LEVEL	COLOR CODING
110199	10190356	Low	Green
110200	10190357	Medium	Yellow
110201	10190358	High	Red

MSA Bright Mesh SunShade Protectors for Helmets

Use the SunShades Protector to protect ears and neck from sun and heat, but also to enhance visibility with contrasting color band and reflective striping. They are made of breathable bright mesh fabric to help you keep cool. Easily clips on hats to prevent it from falling or rotating. Fit most hats and caps.

INCLUDES

Sun protector ONLY



C&M PART #	MFG PART #	COLOR
110193	10098032	Yellow-Green
110194	10098031	Orange

MSA Sun Shield for V-Gard® Helmets

Sun Shields extend the brim of V-Gard and Topgard protective caps all the way around to help protect wearer's ears and neck from sun's rays. Made of ABS and smoke-tinted polycarbonate front. Made of polyurethane and smoke-tinted Lexan front. I am not sure which is correct. Under highlight for Sun Shields and on the brochure it says PU and Lexan. On the front page of the website it says ABS and PC. Please verify and use the correct material.

INCLUDES

Sun shield ONLY



C&M PART #	MFG PART #	DESCRIPTION
110195	697290	V-Gard Caps Only
110196	697410	V-Gard Hats Only
110197	10039114	V-Gard 500 Caps Only

MSA V-Gard® Flame-Resistant Supreme 2-Piece Liner

Get superior under-the-helmet warmth and protection with these winter liners. Supreme liner offers three layers of true flame resistance (FR) and superior resistance to arc exposure (ATPV of 8 cal/cm2).



C&M PART #	MFG PART #	DESCRIPTION
110190	10118427	Flame-Resistant Supreme 2-Piece Liner

Radians® Granite™ & Quartz™ Hard Hats



The Granite Cap Style and Quartz Full-Brim Hard Hats provide excellent protection while providing style and comfort. Both styles meet ANSI Z89.1-2014 Type 1 Class G & E Standards. Hard hats are made of high-density polyethylene and feature pillowed brow pad, nylon crown strap suspension and vertical height adjustment. Six-point ratchet adjustment system is quick and easy to adjust.

FEATURES & BENEFITS

- Pillowed brow pad
- Nylon crown strap suspensions
- Vertical height adjustment
- Quick ratchet adjustment system
- High density polyethylene construction

CERTIFICATIONS

- Meet ANSI Z89.1-2014 Type 1 Class G & E Standards

C&M PART #	MFG PART #	COLOR
GRANITE CAP-STYLE HARD HATS		
10005468	GHR6-Green	Green
10005467	GHR6-Gray	Gray
10005419	GHR6-Blue	Blue
100054D7	GHR6-Yellow	Yellow
10005493	GHR6-Orange	Orange
10005480	GHR6-Green-HV	Hi-Vis Green
10005481	GHR6-Orange-HV	Hi-Vis Orange
100054D5	GHR6-White	White
100054A7	GHR6-Red	Red
QUARTZ FULL-BRIM HARD HATS		
10058768	QHR6-Green	Green
10058767	QHR6-Gray	Gray
10058719	QHR6-Blue	Blue
100587D7	QHR6-Yellow	Yellow
10058793	QHR6-Orange	Orange
10058780	QHR6-Green-HV	Hi-Vis Green
10058781	QHR6-Orange-HV	Hi-Vis Orange
100587D5	QHR6-White	White
100587A7	QHR6-Red	Red
10058743	QHR6-Dark Gray	Dark Gray

REPLACEMENT PARTS & ACCESSORIES

C&M PART #	MFG PART #	DESCRIPTION
100144	HG-410-A4F	Universal Cap Adapter
100691	V40815-C	Clear PC Face Shield
100620	V40815-CP	Universal Clear PETG (Cap Style Only)

MSA V-Gard® Value Liner Knit Cap

Wear the Value Liner Knit Cap under helmets for extra warmth and protection.



C&M PART #	MFG PART #	DESCRIPTION
110189	10118417	Value Liner, Knit Cap, Set of 12

Radians® Nordic Blaze® Thermal Hard Hat Liners

Protect your head and neck from cold, harsh elements with Nordic Blaze warming gear. They have a hook and loop closure that easily attaches to your internal hard hat system so they stay put under the hard hat. The RWL19 is a lightweight dual-layer liner with a chin strap. It has an outer layer to block out wind and inner fleece thermal layer to keep heat in. The RWL17 is a shoulder length dual-layer liner. The quilted outer layer blocks out chilly weather and the inner fleece thermal layer keeps in heat.



C&M PART #	MFG PART #	DESCRIPTION
100127	RWL19	Thermal Hard Hat Liner
100145	RWL17	Quilted Shoulder Length Thermal Hard Hat Liner

Radians® SE-Treated Mesh Neck Shades

The SE Treated Hi-Vis Neck Shades are a lightweight cooling device that has a universal fit for both cap-style and full-brim hard hats. It protects the neck by shading from harmful UV rays, while offering additional visibility.

CERTIFICATIONS

- Meets ASTM D6413 FR Standards

C&M PART #	MFG PART #	COLOR
100128	NSG-UNIV	Hi-Viz Green
100129	NSO-UNIV	Hi-Viz Orange



Radians® Tree Trimmer Combo Hard Hat

Radians Tree Trimmer Combo Hard Hat includes foam filled, padded earcups and mesh visor with a ratchet suspension hard hat to provide complete protection.

FEATURES & BENEFITS

- Adjustable headband slides to fit most sizes
- Lightweight durable construction

CERTIFICATIONS

- Meets ANSI Z89.1-2019 Type 1 Class G & E

C&M PART #	MFG PART #	COLOR
10041593	300-ORVM	Orange



Radians® Arctic Radwear® Head Shades

Combat heat stress and fatigue with Arctic Radwear Head Shades. They are made with advanced ARCTIC™ technology that accelerates the evaporative cooling process to keep you cool during hot outdoor activities, such as construction work, tough workouts or any strenuous outdoor or indoor activity. Just soak the band in water for 2 to 3 minutes and then wear it for up to 5 hours of cooling relief. Our patent pending stretch-fit spandex design allows the band to move with your body, not against it, allowing for optimum blood circulation, keeping you cooler and providing a noticeably more comfortable fit than standard headbands.

C&M PART #	MFG PART #	COLOR
100063	RCS305	Blue
100064	RCS309	Camo



Radians® Nordic Blaze® Hinged Fleece Balaclavas

Made from premium 100% soft polyester fleece, the balaclavas provide superior warmth and versatility. A functional hinge and long-length design lets you wear it as a full-face mask, neck gaiter or face shield. The wind-resistant fabric over the nose, mouth and neck provides extra protection in key areas vulnerable to wind and bitter cold. Mesh fabric over mouth facilitates breathing.

C&M PART #	MFG PART #	COLOR
100561	RWL25BK	Black
100562	RWL25HVG	Hi-Viz Green



Radians® TRPX™ Earmuffs



100240E8



10024080



These earmuffs are a type of personal protective equipment (PPE) designed to protect your ears from excessive noise exposure. They are commonly used in construction and where individuals are exposed to high levels of noise. They help prevent hearing damage and reduce the risk of noise-induced hearing loss, which can be permanent.

Noise Reduction Rating (NRR) is an important factor when choosing earmuffs, which indicates the level of noise reduction provided by the earmuffs. The higher the NRR, the greater the protection offered. It's also crucial to ensure a proper fit to maximize effectiveness.

FEATURES & BENEFITS

- Padded, moisture wicking headband moves moisture away from your head
- Compact folding feature for easy storage
- Soft, foam filled ear cushions provides a comfortable seal.
- Adjustable headband provides a custom fit
- NRR 29 dB

C&M PART #	MFG PART #	DESCRIPTION
100240E8	TR29-BX	TRPX 29 Earmuff, Black & Gray
10024080	TROHVG-BX	TRPX High Visibility 29 Earmuff with reflective material, Hi-Vis Green

CHECK US OUT ONLINE

We're always adding new products. Visit supply.coreandmain.com for our latest additions.

Radians® Resistor II Reusable Flanged Earplugs



Reusable soft, flexible thermoplastic rubber Flanged Earplugs provide superior comfort and protection. Four tapered flanges create a seal in the ear canal to blocking out unwanted noise—ideal for individuals who are regularly exposed to loud environments, such as construction workers, musicians or frequent concertgoers. The corded model comes with a PVC dielectric cord to conveniently hang around neck.

FEATURES & BENEFITS

- Four flanges for a safe, accurate and comfortable seal
- Reusable—simply clean with soap and water
- Latex free
- NRR 27 dB

C&M PART #	MFG PART #	DESCRIPTION	QUANTITY
100212	FP42	Non-Corded	100 Pairs/Box
100437	FP43	Corded	100 Pairs/Box

Radians® Deterrent® 32 Disposable Foam Earplugs



The Deterrent 32 Disposable Foam Earplugs feature soft, slow-recovery foam for extreme comfort and outstanding noise reduction to protect your hearing. The earplugs are easy to roll down and insert and expand slowly for a low-pressure fit in virtually any size ear canal. Available in both corded and uncorded. The corded model comes with a PVC dielectric cord to conveniently hang around neck.

FEATURES & BENEFITS

- Comfortable wing shape
- Dual color—yellow and green
- Extremely soft foam

CERTIFICATIONS

- ANSI S3.19

C&M PART #	MFG PART #	DESCRIPTION	QUANTITY
100435	FP35	Corded	200 Pairs/Box
100436	FP34	Non-corded	200 Pairs/Box
100044	FP34BG50	Non-corded	50 Pairs/Bag

Radians® Resistor 32 Disposable Foam Earplugs

These Disposable Foam Earplugs are made of soft, expandable foam material that conforms to the shape of the ear canal when inserted. This allows them to create a snug and effective seal, blocking out unwanted noise. They are compact and portable, making them ideal for on-the-go use. Simply discard after use.



FEATURES & BENEFITS

- Comfortable, tapered shape
- Smooth shiny surface repels dirt
- Low pressure, self-adjusting foam offers extended comfort and quick recovery time
- NRR 32 dB

C&M PART #	MFG PART #	DESCRIPTION	QUANTITY
100046	FP70BG50	Non-Corded	50 Pairs/Bag
100700	FP70	Non-Corded	200 Pairs/Box
100078	FP71	Corded	100 Pairs/Box

Radians® Refillable Dispenser with Earplugs

The Refillable Earplug Dispensers are a practical solution for providing easy access to hearing protection in various settings. Place on countertop or wall mount the dispenser. Durable cannisters keep plugs clean and dispense one earplug at a time. Dispensers come filled with 500 pairs of disposable earplugs for your convenience. The top easily separates from base for quick and economical filling.



FEATURES & BENEFITS

- Wall mount or place on countertop
- Dispenses earplugs hygienically
- NRR 32 dB

C&M PART #	MFG PART #	DESCRIPTION
100204	FPD-500L70	Includes 500 pairs of Orange Resistor™ FP70 Earplugs
100438	FPD-500L34	Includes 500 pairs of Green Deterrent™ FP34 Earplugs

Radians® Arctic Radwear® Cooling Towel

The Arctic Radwear Cooling Towels are made with advanced ARCTIC™ technology that accelerates the evaporative cooling process. The cooling towels keep you cool during hot outdoor activities, such as construction work, tough workouts or any strenuous outdoor or indoor activity. Just soak the towel in water for 2 to 3 minutes and then experience cooling relief for up to 5 hours. Towels are anti-microbial treated to prevent mold build-up and unwanted smells. Measures 26" x 17".



C&M PART #	MFG PART #	COLOR
100047	RCS10	Blue
100048	RCS11	Hi-Vis Green

Radians® Arctic Radwear® Cooling Wrap XT

The Arctic Radwear® Cooling Wrap is made with advanced ARCTIC™ technology that accelerates the evaporative cooling process. The cooling wrap is designed to keep you cool during hot outdoor activities, such as construction work, tough workouts or any strenuous outdoor or indoor activity. Just soak the wrap in water for 2 to 3 minutes and then experience cooling relief for up to 5 hours. Wrap is anti-microbial treated to prevent mold build-up and unwanted smells. Pull through slot opening to secure around neck. Measures 32.5" x 12".



C&M PART #	MFG PART #	COLOR
100636	RCS20	Blue

Acme United Heat Stress Kit, Plastic Case

Keep your employees safe from the dangers of excessive temperatures with this heat stress kit. The rugged, weatherproof plastic case is wall mountable yet has a handle for easy carrying. Stay OSHA compliant at your contractors, construction or industrial site with this 72-piece kit.



C&M PART #	MFG PART #	DESCRIPTION
110613	5250-001	Heat Stress Kit, Plastic Case

Igloo 5-Gallon Cooler



112247



112248



112249

Keep your beverages cool with the Igloo 5-Gallon Water Cooler. Durable high-density polyethylene exterior and an insulated interior help maintain the temperature of the contents. The cooler features a drip-resistant spigot for easy pouring and a pressure-fit lid to keep the drinks secure.

C&M PART #	MFG PART #	COLOR
112247	00000451	Yellow/Red

REPLACEMENT PARTS & ACCESSORIES

C&M PART #	MFG PART #	DESCRIPTION
112248	00025041	Wire Rack Fits 2 thru 5 Gallon Coolers
112249	00009534	Cup Dispenser

Pelican 20-Qt Elite Coolers

These rugged and high-performance 20-qt coolers keep your food and beverages cold in demanding environments. Coolers feature thick polyurethane insulation that provides excellent ice retention, keeping your contents cold for an extended period.



108306SN



108306SR

Sturdy construction with a durable rotomolded exterior makes them resistant to impacts, UV rays and even bears. A secure press-and-pull latching system keeps the lid tightly sealed, preventing any heat from entering. Built-in features such as molded-in cup holders, a drain plug and nonskid rubber feet provide added convenience.



C&M PART #	MFG PART #	COLOR
108306SN	20Q-1-CLBLUGRY	Cool Blue/Gray
108306SQ	20Q-1-TANWHT	Tan/White
108306SR	20Q-1-DKGRYEGRN	Dark Gray/Green
108306SS	20Q-14-GNMTLOD	Gunmetal/OD Green

Igloo Playmate Pal Cooler

This compact cooler is great for keeping your drinks and snacks cool on-the-go. The 7-quart capacity insulated cooler is suitable for holding a few cans and small food items. A swing-up bail handle makes it easy to carry and a hinged lid offers quick access to the contents.



C&M PART #	MFG PART #	DESCRIPTION	CAPACITY
112250	00007362	Playmate Pal 7-Qt Cooler, Red	Nine 12-oz Cans

Sqwincher® Fast Pack Liquid Concentrate

With the Fast Pack there is no mixing required. Each Fast Pack is a liquid concentrate that you can add to with water to create a refreshing and hydrating beverage. It replenishes electrolytes, including sodium, potassium, magnesium, and calcium, and helps prevent dehydration, making it popular among athletes, outdoor enthusiasts, and individuals working in physically demanding jobs.



Simply tear open the packet, pour the liquid concentrate into a bottle and shake. Each 0.6 oz packet yields one 6 oz flavored drink. Use packet as a drinking cup.

C&M PART #	MFG PART #	FLAVOR	QUANTITY
112145	SQW-159015301	Cherry	50/Pack
112146	SQW-159015305	Fruit Punch	50/Pack
112147	SQW-159015302	Grape	50/Pack
112148	SQW-159015303	Lemonade	50/Pack

Sqwincher® 2.5 Gallon Powder Concentrate

The 2.5-gallon powder concentrate is a concentrated form of the Sqwincher drink. Mix it with water to create a larger volume of the beverage. The mix is designed to restore important mineral salts and fluids lost through dehydration, physical exertion and heat stress. Ideal for use in industrial or commercial settings where a large amount of hydration solution is needed, such as construction sites, factories or sports facilities.



C&M PART #	MFG PART #	FLAVOR	QUANTITY
112133	SQW-159016044	Assorted	32/Case

Sqwincher® Freezer Pack

These freezer packs are designed to provide a refreshing and hydrating experience, especially in hot or physically demanding environments. They are a convenient and portable way to replenish electrolytes, including sodium, potassium, magnesium, and calcium, and combat dehydration.



C&M PART #	MFG PART #	DESCRIPTION	FLAVOR	QUANTITY
112143	SQW-159200201	Frozen Electrolyte Popsicle	Assorted	150/Pack
112144	SQW-159200231	Frozen Electrolyte Freezer Pops	Assorted	150/Pack

Sqwincher® Qwik Stik® Tubes



The Qwik Stik beverage mix is a powdered drink mix that you can mix with water to create a refreshing and hydrating beverage. It replenishes electrolytes, including sodium, potassium, magnesium and calcium, and helps prevent dehydration, making it popular among athletes, outdoor enthusiasts and individuals working in physically demanding jobs.

Simply tear open a packet, pour the powder into a bottle or cup of water and stir until dissolved. Each mix yields 20 oz of flavored drink.

C&M PART #	MFG PART #	FLAVOR	QUANTITY
112134	SQW-159060102	Fruit Punch	50/Pack
112135	SQW-159060106	Lemon Lime	50/Pack
112136	SQW-159060101	Mixed Berry	50/Pack
112137	SQW-159060109	Cool Citrus	50/Pack
112138	SQW-159060107	Grape	50/Pack
112139	SQW-159060103	Lemonade	50/Pack
112140	SQW-159060100	Orange	50/Pack
112141	SQW-159060099	Strawberry Lemonade	50/Pack
112142	SQW-159060119	Assorted Flavors	200/Case



MSA OptimAir® Mask-Mounted Advantage 3100 PAPR with Facepiece Kits

Specifically designed to work with Advantage® 3000, Advantage 4000, Ultravue® and Ultra Elite® facepieces, the OptimAir MM2K powered air-purifying respirator (PAPR) is precision-crafted to offer long life, high performance and low maintenance. The compact, easy-to-decontaminate model uses a rechargeable NiMH battery for 8 hours of continuous use, while a dual-rate smart charger fully powers a discharged battery in less than three hours. The water-resistant HEPA filter helps protect against particulate contaminants. The light blower attaches to the facepiece, while the Type HE Optifilter® cartridges remove particulates.



INCLUDES

Motor/blower, NiMH battery, dual-rate battery charger and cable, one Type HE Optifilter XL cartridge, waist belt and facepiece

CERTIFICATIONS

- NIOSH - 818105 / 42 CFR, Part 84

C&M PART #	MFG PART #	MASK TYPE	CARTRIDGES & FILTERS	PPE SIZE
110211	10095182	PAPR System Full-Mask	OptiFilter XL	Medium
110212	10095183	PAPR System Full-Mask	OptiFilter XL	Large

Honeywell North 7600 Series FFP Respirator

This Full Facepieces Respirator has 100% medical grade silicone sealing area with dual flange for superior fit and comfort. Lens offers 200-degree range of vision and reduced fogging. A five-strap harness and chin support provides a secure fit. Latex free.



105003

Honeywell



105007

C&M PART #	MFG PART #	MASK TYPE	CARTRIDGES & FILTERS	PPE SIZE
105003	760008A	Full-Mask	N-Series	M/L

REPLACEMENT PARTS & ACCESSORIES

C&M PART #	MFG PART #	CARTRIDGE TYPE	QUANTITY
105006	75SCP100L	Multi-Purpose	2/Pack
105007	7580P100	P100 Particle Filter	2/Pack
105008	7581P100L	Organic Vapors	2/Pack
105009	7583P100L	Organic Vapors and Acid Gases	2/Pack

MSA Advantage® 3200 Full-Facepiece Respirators

The Advantage 3200 full-face masks offer complete protection and unparalleled comfort. The soft hypoallergenic silicone sealing line provides a pressure free fit. The large, optically corrected lens ensures a clear, undistorted view, while the grey blue color gives the mask an aesthetic appearance. Donning the Advantage 3200 is unbelievably quick, simple and accomplished without painful hair pulling. The patented Advantage head harness gives a perfect facepiece-to-face fit. Order cartridges separately. They feature bayonet-style design for quick mounting and locks into place with one twist.



110205



110208



INCLUDES

Respirator Only

CERTIFICATIONS

- NIOSH - 42 CFR, Part 84

C&M PART #	MFG PART #	MASK TYPE	CARTRIDGES & FILTERS	PPE SIZE
110204	10028995	Full-Mask	Advantage	Medium
110205	10028997	Full-Mask	Advantage	Large

REPLACEMENT PARTS & ACCESSORIES

C&M PART #	MFG PART #	CARTRIDGE TYPE	QUANTITY
110206	815357	Organic Vapor/Acid Gas (GMC)	2/Pack
110207	815366	Multigas / P100 (GME)	2/Pack
110208	815355	Organic Vapor (GMA)	2/Pack
110209	815359	Multigas (GME)	2/Pack
110210	815362	Organic Vapor / P100 (GMA)	2/Pack

MSA G1 Facepiece with Twin Cartridge APR Adapter

MSA G1 twin port adapter snaps into place to cover a wide variety of respiratory applications. The twin cartridge adapter works with the Advantage respirator cartridges.



INCLUDES

Dual cartridge adapter ONLY

CERTIFICATIONS

- NIOSH - 42 CFR, Part 84

C&M PART #	MFG PART #	DESCRIPTION
110216	10199720	Twin Cartridge APR Adapter for G1 Facepiece



Honeywell North Head Cap/ Hard Hat + Faceseal



The Primair® 900 (PA900) Series Headgear offers protection from dust, gases and chemicals. They are engineered around three core pillars: Comfort, Ease-of-Use and Ergonomics, all while designed to feature the highest protection levels and PPE compatibility with the end user front of mind. Available as a cap or a hat, these lightweight headgears are easy to put on and off as well as easy to maintain.

CERTIFICATIONS

- APF 25 with PA700 PAPR

C&M PART #	MFG PART #	DESCRIPTION	CARTRIDGES & FILTERS
105015	PA911	Head Cap, Faceseal and Breathing Tube	North Cartridge/Filter
105016	PA921	Hard Hat, Faceseal and Breathing Tube	North Cartridge/Filter

REPLACEMENT PARTS & ACCESSORIES

C&M PART #	MFG PART #	DESCRIPTION	QUANTITY
105010	PA70IHED	PAPR Starter Kit HEPA, DECON	-
105011	PA7HE	HEPA Filter	5/Pack
105012	PA7OVAGHE	HEPA/OV/AG/HE Filter	4/Pack
105013	PA7OVVHE	HEPA/OV Filter	4/Pack
105014	PA7DEHE	HEPA/ OV/AG/AM/MA/FM/HE Filter	4/Pack

Honeywell North 7700 Premium Silicone Half-Mask Respirators



The Half-Mask Respirators are made from 100% medical grade silicone. The wide sealing area provides exceptional fit and comfort. The cradle suspension features woven straps that provide maximum mobility without sacrificing support. Easily converts to PAPR or supplied air.

INCLUDES

Half Mask Respirator

C&M PART #	MFG PART #	MASK TYPE	CARTRIDGES & FILTERS	PPE SIZE
105004	770030M	Premium Silicone Half Mask	N-Series	Medium
105005	770030L	Premium Silicone Half Mask	N-Series	Large

REPLACEMENT PARTS & ACCESSORIES

C&M PART #	MFG PART #	FILTER TYPE	QUANTITY
105011	PA7HE	HEPA Filter	5/Pack
105012	PA7OVAGHE	HEPA/OV/AG/HE Filter	4/Pack
105013	PA7OVVHE	HEPA/OV Filter	4/Pack
105014	PA7DEHE	HEPA/ OV/AG/AM/MA/FM/HE Filter	4/Pack

MSA Advantage® 200 LS Half-Face Respirators

The Advantage 200 LS Half-Face Respirators are comfortable, efficient and economical. With its patented MultiFlex system these respirators offer maximum protection and high wearing comfort. The soft, pliable combination of rubber and plastic provides a customized and pressure-free fit, instantly conforming to the wearer's unique facial characteristics.

INCLUDES

Respirator Only

CERTIFICATIONS

- NIOSH - 42 CFR, Part 84

C&M PART #	MFG PART #	MASK TYPE	CARTRIDGES & FILTERS	PPE SIZE
110202	815444	Half-Face	Advantage	Medium
110203	815452	Half-Face	Advantage	Large



REPLACEMENT PARTS & ACCESSORIES

C&M PART #	MFG PART #	CARTRIDGE TYPE	QUANTITY
110206	815357	Organic Vapor/Acid Gas (GMC)	2/Pack
110207	815366	Multigas / P100 (GME)	2/Pack
110208	815355	Organic Vapor (GMA)	2/Pack
110209	815359	Multigas (GME)	2/Pack
110210	815362	Organic Vapor / P100 (GMA)	2/Pack

Allegro Respirator Cleaning Pads



These large 5" x 8" individually foil-packaged towelettes containing 70% isopropanol are designed specifically to clean rubber respirator facepieces. Wall mount box for easy dispensing.

C&M PART #	MFG PART #	DESCRIPTION	MATERIAL	QUANTITY
105061	1001	Alcohol Respirator Cleaning Pads	Non-Woven	100/Pack

Allegro Respirator Storage Bag



Reusable storage bag with plastic zipper keeps equipment secure and contaminant free. Large transparent bag measures 14" x 16" and is made from tough 10-mil thick poly for durability.

C&M PART #	MFG PART #	DESCRIPTION	MATERIAL	QUANTITY
105062	2000	Respirator Storage Bag	10-mil Poly	1 Bag

MSA G1 Industrial Self-Contained Breathing Apparatuses (SCBA)

The G1 Industrial SCBA contains many unique design features that reduce stress and fatigue while improving performance and ease of maintenance. The new G1 iRC (industrial remote cylinder connection) version is a SCBA platform that features a remote cylinder connection, available with both threaded and quick connect attachments. It allows for cylinder compatibility among other MSA SCBA such as the G1 NFPA, AirHawk® II and Firehawk® M7.



INCLUDES

110217 includes: low-pressure aluminum cylinder, nylon harness without padding and chest strap and medium G1 facepiece with polyester head harness

110218 includes: high-pressure, low-profile carbon cylinder; nylon harness with shoulder and lumbar pads; no chest strap; medium G1 facepiece with polyester head harness and hard case

CERTIFICATIONS

- NIOSH - 42 CFR, Part 84

C&M PART #	MFG PART #	DESCRIPTION	CAPACITY
110217	10215806	Low-Pressure SCBA Cylinder	30 Minutes
110218	10215807	High-Pressure SCBA Cylinder	45 Minutes

REPLACEMENT PARTS & ACCESSORIES

C&M PART #	MFG PART #	DESCRIPTION	EXTERIOR (L x W x H)	INTERIOR (L x W x H)
107278	1650-020-110	1650 Protector Case	31.6" x 20.5" x 12.5"	28.6" x 17.5" x 10.7"

Local Knowledge
Local Experience
Local Service, Nationwide®

Count on Core & Main to provide a quality product assortment from trusted brands, access to industry and product experts, and best-in-class service.



MSA PremAire® Cadet Escape Air-Line Respirator with Advantage® 4000 Facepiece



This combination supplied-air respirator with SCBA is designed especially for escape. Versatile, comfortable and affordable, it features a single-assembly first-stage regulator and cylinder valve. Small and low profile, it is ideal for working in tight places.

INCLUDES

Escape respirator, 5-minute aluminum egress cylinder, nylon strap carrier/harness, Advantage 4000 facepiece, Hycar® polyester net head harness and Hansen brass fittings

CERTIFICATIONS

- NIOSH - 42 CFR, Part 84

C&M PART #	MFG PART #	TYPE	TANK CAPACITY	MASK TYPE
110219	10092034	Airline Respirator	5 Minutes	Full-Face

MSA TransAire® 5 &10 Escape Respirators



These self-contained devices help personnel escape dangerous and deadly atmospheres, including those with high concentrations of toxic gases or vapors or oxygen deficiency. Low profile, lightweight and easy to carry, these escape respirators feature one-control operation for a swift exit.

INCLUDES

Air supply, regulator, tubing, hood and strap

CERTIFICATIONS

- NIOSH - 42 CFR, Part 84

C&M PART #	MFG PART #	TYPE	TANK CAPACITY	MASK TYPE
110213	10008292	TransAire Emergency Escape	5 Minutes	Hood
110214	10008293	TransAire Emergency Escape	10 Minutes	Hood

MSA G1 PremAire® Cadet Escape Air-Line Respirator

The G1 PremAire Cadet Escape Respirator combines supplied air respirator with escape cylinder for a streamlined, lightweight system. Low-profile, open-port (G1) facepiece design offers cross contamination protection. Compact one-piece assembly with both first-stage regulator and cylinder valve helps fit in tight areas.



INCLUDES

Escape airline respirator, 5-minute aluminum cylinder and nylon carrier

CERTIFICATIONS

- NIOSH - 42 CFR, Part 84

C&M PART #	MFG PART #	TYPE	TANK CAPACITY	MASK TYPE
110220	10192834	Confined-Space Respirator	5 Minutes	Full-Face

Allegro Bitter (Denatonium Benzoate) Respirator Fit Test Kit



This kit offers qualitative OSHA compliant fit testing for disposable and reusable dust and mist respirators. Denatonium Benzoate creates an unmistakable bitter taste that indicates breakthrough in the respirator fit. New disposable glass ampules make pouring solution into nebulizers easier and reduces the chance of contamination.

INCLUDES

Test hood, sensitivity nebulizer, test nebulizer with atomizer, wire cleaner, one box of sensitivity solution, (six ampules) and one box of test solution (six ampules)

C&M PART #	MFG PART #	DESCRIPTION
105063	2041	Bitter Fit Test Kit

Radians® Neese I96 Series Chem Shield Suits

These economy I96 Series Chem Shield Suits offer basic industrial splash protection with PVC/Polyester coating on both sides. Tested to ASTM F903 for liquid penetration, it is ideal for situations that require protection such as sanitation, sewer & water works and agriculture. Suits have a stand-up collar for detachable hood and strong double-welded seams for durability and reinforcement.

FEATURES & BENEFITS

- Neck tab on collar
- Raglan shoulder design
- Inner sleeves on arms with elastic
- Snap front closure
- Bib front trousers

CERTIFICATIONS

- ASTM F903



C&M PART #	MFG PART #	SIZE
10022768SM	10096-55-1-GRN-S	S
10022768SM	10096-55-1-GRN-M	M
10022768SM	10096-55-1-GRN-L	L
10022768SM	10096-55-1-GRN-XL	XL
10022768SM	10096-55-1-GRN-2X	2X
10022768SM	10096-55-2-GRN-3X	3X

Radians Type R Class 2 Black Bottom Economy Mesh Safety Vests

The SV3B Hi-Viz Top/Black Bottom Mesh Safety Vests are an excellent economical choice for extreme work environments that reduce the life of the vest and short-term labor. High-visibility green and orange colors with reflective silver tape ensure the wearer is highly visible. The 100% polyester mesh material keeps workers cool.

FEATURES & BENEFITS

- Zipper closure
- 2" horizontal and vertical reflective silver tape stripes
- Left shoulder mic tab
- Three pockets: upper front chest outside, lower right outside and lower left inside



CERTIFICATIONS

- Meets ANSI/ISEA 107 and Type R / Class 2

C&M PART #	MFG PART #	COLOR	SIZE
10062978MD	SV3B-2ZGM-M	Hi-Vis Green/Black	M
10062978LG	SV3B-2ZGM-L	Hi-Vis Green/Black	L
10062978XL	SV3B-2ZGM-XL	Hi-Vis Green/Black	XL
100629782X	SV3B-2ZGM-2X	Hi-Vis Green/Black	2X
100629783X	SV3B-2ZGM-3X	Hi-Vis Green/Black	3X
10062995MD	SV3B-2ZOM-M	Hi-Vis Orange/Black	M
10062995LG	SV3B-2ZOM-L	Hi-Vis Orange/Black	L
10062995XL	SV3B-2ZOM-XL	Hi-Vis Orange/Black	XL
100629952X	SV3B-2ZOM-2X	Hi-Vis Orange/Black	2X
100629953X	SV3B-2ZOM-3X	Hi-Vis Orange/Black	3X

Radians Type R Class 2 Two-Tone Trim Economy Mesh Safety Vests

The SV22-2 Two-Tone Trim Economy Mesh Safety Vests provides compliant protection at an economical price. They are excellent for extreme work environments like asphalt paving that greatly reduce the useful life of a vest or protection for short-term labor. Reflective stripes on contrasting trim make workers much more noticeable in low light and broad daylight. The 100% polyester mesh material keeps workers cool.

FEATURES & BENEFITS

- Zipper closure
- 2" vertical and horizontal reflective silver tape stripes
- Two pockets: upper left front outside and lower right inside
- Contrasting trim detail



CERTIFICATIONS

- Meets ANSI/ISEA 107 and Type R/ Class 2

C&M PART #	MFG PART #	COLOR	SIZE
10011180MD	SV22-2ZGM-M	Hi-Vis Green	M
10011180LG	SV22-2ZGM-L	Hi-Vis Green	L
10011180XL	SV22-2ZGM-XL	Hi-Vis Green	XL
100111802X	SV22-2ZGM-2X	Hi-Vis Green	2X
100111803X	SV22-2ZGM-3X	Hi-Vis Green	3X
10011181MD	SV22-2ZOM-M	Hi-Vis Orange	M
10011181LG	SV22-2ZOM-L	Hi-Vis Orange	L
10011181XL	SV22-2ZOM-XL	Hi-Vis Orange	XL
100111812X	SV22-2ZOM-2X	Hi-Vis Orange	2X
100111813X	SV22-2ZOM-3X	Hi-Vis Orange	3X

Radians Type R Class 2 Single-Color Economy Mesh Safety Vests

The SV2Z Single-Color Economy Type R Class 2 Safety Vests offer compliant protection at an economical price. They are excellent for extreme work environments like asphalt paving that greatly reduce the useful life of a vest or protection for short-term labor. The 100% polyester mesh material keeps workers cool.



FEATURES & BENEFITS

- Zipper closure
- 2" vertical and horizontal reflective silver tape stripes
- Two pockets: upper left front outside and lower right inside

CERTIFICATIONS

- Meets ANSI/ISEA 107 and Type R / Class 2

C&M PART #	MFG PART #	COLOR	SIZE
10015880MD	SV2ZGMM	Hi-Vis Green	M
10015880LG	SV2ZGML	Hi-Vis Green	L
10015880XL	SV2ZGML	Hi-Vis Green	XL
100158802X	SV2ZGM2X	Hi-Vis Green	2X
100158803X	SV2ZGM3X	Hi-Vis Green	3X
10015881MD	SV2ZOMM	Hi-Vis Orange	M
10015881LG	SV2ZOML	Hi-Vis Orange	L
10015881XL	SV2ZOMXL	Hi-Vis Orange	XL
100158812X	SV2ZOM2X	Hi-Vis Orange	2X
100158813X	SV2ZOM3X	Hi-Vis Orange	3X

Radians Type R Class 3 Two-Tone Trim Economy Mesh Safety Shirts with Zipper

The SV22-3 Two-Tone Trim Economy Type R Class 3 Safety Shirts offer compliant protection at an economical price. Excellent choice for extreme work environments like asphalt paving that greatly reduce the useful life of a vest or protection for short-term labor. Reflective stripes on contrasting trim and longer sleeve length make workers much more noticeable in low light and broad daylight. Great for roadway construction workers, utility workers, survey crews and emergency response personnel. The 100% polyester mesh material keeps workers cool.



FEATURES & BENEFITS

- Zipper closure
- 2" vertical, horizontal and around the sleeve reflective silver tape stripes
- Contrasting trim detail
- Two pockets: upper left front outside and lower right inside

CERTIFICATIONS

- Meets ANSI/ISEA 107 and Type R/ Class 3

C&M PART #	MFG PART #	COLOR	SIZE
10031380MD	SV22-3ZGM-M	Hi-Vis Green	M
10031380LG	SV22-3ZGM-L	Hi-Vis Green	L
10031380XL	SV22-3ZGM-XL	Hi-Vis Green	XL
100313802X	SV22-3ZGM-2X	Hi-Vis Green	2X
100313803X	SV22-3ZGM-3X	Hi-Vis Green	3X
10031381MD	SV22-3ZOM-M	Hi-Vis Orange	M
10031381LG	SV22-3ZOM-L	Hi-Vis Orange	L
10031381XL	SV22-3ZOM-XL	Hi-Vis Orange	XL
100313812X	SV22-3ZOM-2X	Hi-Vis Orange	2X
100313813X	SV22-3ZOM-3X	Hi-Vis Orange	3X

Radians Type R Class 2 Breakaway Expandable Two-Tone Mesh Safety Vests

The SV24-2 Breakaway Expandable Two-Tone Type R Class 2 Safety Vests have adjustable sides to provide a more comfortable, customized fit. A 5-point breakaway system, on the right and left shoulder, right and left sides and Zip-N-Rip™ front closure, is designed so the vest comes apart if it is caught in a machinery ensuring worker safety. The 100% polyester mesh material keeps workers cool.



FEATURES & BENEFITS

- 5-point breakaway system ensure worker safety
- Badge holder with opening on the side
- Zip-N-Rip front closure
- 2" vertical and horizontal reflective silver tape stripes
- Contrasting trim detail
- Mic tabs on both shoulders
- Five pockets: 2 lower inside, 2 upper chest outside and 1 divided upper chest

CERTIFICATIONS

- Meets ANSI/ISEA 107 and Type R/ Class 2

C&M PART #	MFG PART #	COLOR	SIZE
10033480LG	SV24-2ZGM-M/L	Hi-Vis Green	M/L
100334802X	SV24-2ZGM-XL/2X	Hi-Vis Green	XL/2X
100334805X	SV24-2ZGM-3X/5X	Hi-Vis Green	3X/5X
10033481LG	SV24-2ZOM-M/L	Hi-Vis Orange	M/L
100334812X	SV24-2ZOM-XL/2X	Hi-Vis Orange	XL/2X
100334815X	SV24-2ZOM-3X/5X	Hi-Vis Orange	3X/5X



Radians Type R Class 2 Heavy-Duty Two-Tone Woven/Mesh Engineer Vests

The SV55 Heavy-Duty Two-Tone Engineer Type R Class 2 Safety Vests are intended for professional field engineers and construction superintendents. Rugged 300D woven polyester front provides resistance to tough working conditions while supporting extra weight in cargo pockets. Reflective material is utilized for reinforcement edge binding further enhancing nighttime visibility. Numerous multifunction pockets hold upside down paint, water bottles and tablets. The 100% polyester mesh back keeps workers cool.



FEATURES & BENEFITS

- Heavy-duty #8 zipper closure
- All-around reflective trim edging and 2" vertical and horizontal 3M® 8712 silver glass bead reflective tape stripes
- 1" contrasting trim detail
- Dual mic tabs
- 15 pockets to hold pencils, radio, water bottle, paint cans and more!

CERTIFICATIONS

- Meets ANSI/ISEA 107 and Type R/ Class 2

C&M PART #	MFG PART #	COLOR	SIZE
10034880MD	SV55-2ZGD-M	Hi-Vis Green	M
10034880LG	SV55-2ZGD-L	Hi-Vis Green	L
10034880XL	SV55-2ZGD-XL	Hi-Vis Green	XL
100348802X	SV55-2ZGD-2X	Hi-Vis Green	2X
100348803X	SV55-2ZGD-3X	Hi-Vis Green	3X
10034881MD	SV55-2ZOD-M	Hi-Vis Orange	M
10034881LG	SV55-2ZOD-L	Hi-Vis Orange	L
10034881XL	SV55-2ZOD-XL	Hi-Vis Orange	XL
100348812X	SV55-2ZOD-2X	Hi-Vis Orange	2X
100348813X	SV55-2ZOD-3X	Hi-Vis Orange	3X

Radians Type R Class 2 Heavy-Duty Surveyor Safety Vests

The SV59B Heavy-Duty Type R Class 2 Surveyor Safety Vests feature heavy webbing reinforced edging for durability. These surveyor vests have large back "plan" pocket with a snap closure that spans lower half of the entire vest and grommets at neck for tool tethers. The mesh upper, front and back, provide breathability and comfort. The pockets are crafted in tough woven twill fabric to provide maximum durability.



FEATURES & BENEFITS

- Heavy webbing reinforced edging and woven polyester twill black bottom
- Zipper front closure
- 2" vertical and horizontal glass bead reflective tape stripes
- Left shoulder mic tab
- Grommets at neck for tool tethers
- Nine pockets, including a split pencil 4-segment upper left chest pocket

CERTIFICATIONS

- Meets ANSI/ISEA 107 and Type R/Class 2

C&M PART #	MFG PART #	COLOR	SIZE
10036678MD	SV59B-2ZGM-M	Hi-Vis Green/Black	M
10036678LG	SV59B-2ZGM-L	Hi-Vis Green/Black	L
10036678XL	SV59B-2ZGM-XL	Hi-Vis Green/Black	XL
100366802X	SV59B-2ZGM-2X	Hi-Vis Green/Black	2X
100366783X	SV59B-2ZGM-3X	Hi-Vis Green/Black	3X
10036695MD	SV59B-2ZOM-M	Hi-Vis Orange/Black	M
10036695LG	SV59B-2ZOM-L	Hi-Vis Orange/Black	L
10036695XL	SV59B-2ZOM-XL	Hi-Vis Orange/Black	XL
100366952X	SV59B-2ZOM-2X	Hi-Vis Orange/Black	2X
100366953X	SV59B-2ZOM-3X	Hi-Vis Orange/Black	3X

Radians Type R Class 2 Surveyor Breakaway Two-Tone Safety Vests

The SV46 Surveyor Breakaway Two-Tone Type R Class 2 Safety Vests have Zip-N-Rip™ closure at shoulders, sides, and front zipper closure that breakaway when tugged with moderate force. Excellent choice for environments around moving machinery and equipment to prevent pulling workers into hazards. Contrast trim combinations make workers much more noticeable in low light and broad daylight conditions. Made from 100% polyester solid knit front and 100% polyester mesh back. Mesh back helps workers stay cool.



FEATURES & BENEFITS

- 5-point breakaway system ensure worker safety
- Zip-N-Rip™ closure
- 2" vertical and horizontal reflective silver tape stripes
- Contrasting trim detail
- Eight pockets ensure there is plenty of places to keep items for your job
- Mic Tab on both shoulders

CERTIFICATIONS

- Meets ANSI/ISEA 107 and Type R/Class 2

C&M PART #	MFG PART #	COLOR	SIZE
10052668MD	SV46GM	Hi-Vis Green	M
10052693MD	SV46OM	Hi-Vis Orange	M

Radians Type R Class 2 Heavy-Duty Two-Tone Mesh Surveyor Safety Vests

The SV6H Heavy-Duty Two-Tone Type R Class 2 Surveyor Safety Vests feature reflective edging to enhance reflective brightness. It comes with a multi-function pocket design, including a clear vinyl credential/badge holder, featuring large inside pockets. The vest includes a rear D-Ring pass through for use over fall protection.

FEATURES & BENEFITS

- Heavy-duty #5 zipper closure
- Reinforced webbing for durability
- 2" vertical and horizontal silver glass bead reflective tape stripes
- 1" contrasting trim detail
- Reflective trim edging
- Dual mic tabs
- Grommets at neck for tool keepers/lanyards
- Eight pockets, including a clear vinyl badge holder



CERTIFICATIONS

- Meets ANSI/ISEA 107 and Type R/ Class 2

C&M PART #	MFG PART #	COLOR	SIZE
10044668MD	SV6HG-M	Hi-Vis Green	M
10044668LG	SV6HG-L	Hi-Vis Green	L
10044668XL	SV6HG-XL	Hi-Vis Green	XL
100446682X	SV6HG-2X	Hi-Vis Green	2X
100446683X	SV6HG-3X	Hi-Vis Green	3X
10044693MD	SV6HO-M	Hi-Vis Orange	M
10044693LG	SV6HO-L	Hi-Vis Orange	L
10044693XL	SV6HO-XL	Hi-Vis Orange	XL
100446932X	SV6HO-2X	Hi-Vis Orange	2X
100446933X	SV6HO-3X	Hi-Vis Orange	3X

Radians Type R Class 2 Two-Tone Surveyor Mesh Safety Vests

The SV6 Two-Tone Surveyor Type R Class 2 Safety Vests feature a functional pocket configuration so you can carry the tools you need to do your job. Radio pocket and lower front pockets are covered; inside pockets are extra deep to prevent tools and other items from falling out. Contrast trim combinations make workers much more noticeable in low light and broad daylight.

FEATURES & BENEFITS

- Zipper closure
- 2" vertical and horizontal reflective silver tape stripes
- Contrasting trim detail
- Seven pockets include a clear badge holder
- Mic tab on both shoulders

CERTIFICATIONS

- Meets ANSI/ISEA 107 and Type R/Class 2

C&M PART #	MFG PART #	COLOR	SIZE
10056380MD	SV6-2ZGM-M	Hi-Vis Green	M
10056380LG	SV6-2ZGM-L	Hi-Vis Green	L
10056380XL	SV6-2ZGM-XL	Hi-Vis Green	XL
100563802X	SV6-2ZGM-2X	Hi-Vis Green	2X
100563803X	SV6-2ZGM-3X	Hi-Vis Green	3X
10056381M	SV6-2ZOM-M	Hi-Vis Orange	M
10056381LG	SV6-2ZOM-L	Hi-Vis Orange	L
10056381XL	SV6-2ZOM-XL	Hi-Vis Orange	XL
100563812X	SV6-2ZOM-2X	Hi-Vis Orange	2X
100563813X	SV6-2ZOM-3X	Hi-Vis Orange	3X



Radians Type R Class 3 Color-Blocked Hooded Zippered Safety Sweatshirts

Stay warm while staying visible with the SJ01B-3 Color-Blocked Long Sleeve Hooded Zippered Sweatshirts. Reflective stripes on the sleeves provide added visibility. Color blocking at the bottom front of the sweatshirts conceal dirt.

FEATURES & BENEFITS

- Full front zipper closure
- Black elastic knit waistband and cuffs offer a comfortable fit
- Low-piling polyester fleece material
- Hood with adjustable pull cords
- 2" vertical and horizontal silver reflective tape stripes
- Two lower pouch pockets
- 25 washes max

CERTIFICATIONS

- Meets ANSI/ISEA 107 and Type R/Class 3

C&M PART #	MFG PART #	COLOR	SIZE
10025578MD	SJ01B-3ZGS-M	Hi-Vis Green/Black	M
10025578LG	SJ01B-3ZGS-L	Hi-Vis Green/Black	L
10025578XL	SJ01B-3ZGS-XL	Hi-Vis Green/Black	XL
100255782X	SJ01B-3ZGS-2X	Hi-Vis Green/Black	2X
100255783X	SJ01B-3ZGS-3X	Hi-Vis Green/Black	3X
10025595MD	SJ01B-3ZOS-M	Hi-Vis Orange/Black	M
10025595LG	SJ01B-3ZOS-L	Hi-Vis Orange/Black	L
10025595XL	SJ01B-3ZOS-XL	Hi-Vis Orange/Black	XL
100255952X	SJ01B-3ZOS-2X	Hi-Vis Orange/Black	2X
100255953X	SJ01B-3ZOS-3X	Hi-Vis Orange/Black	3X



Radians Type R Class 3 Color-Blocked Hooded Pullover Safety Sweatshirts

Stay warm while staying visible with the SJ02B-3 Color-Blocked Long Sleeve Hooded Pullover Sweatshirts. Reflective stripes on the sleeves provide added visibility. Color blocking at the bottom front of the sweatshirts conceal dirt.

FEATURES & BENEFITS

- Black elastic knit waistband and cuffs offer a comfortable fit
- Low-piling polyester fleece material
- Hood with adjustable pull cords
- 2" vertical and horizontal silver reflective tape stripes
- One lower large pouch pocket
- 25 washes max



CERTIFICATIONS

- Meets ANSI/ISEA 107 and Type R/Class 3

C&M PART #	MFG PART #	COLOR	SIZE
100540MD	SJ02B-3PGS-M	Hi-Vis Green/Black	M
100540LG	SJ02B-3PGS-L	Hi-Vis Green/Black	L
100540XL	SJ02B-3PGS-XL	Hi-Vis Green/Black	XL
1005402X	SJ02B-3PGS-2X	Hi-Vis Green/Black	2X
1005403X	SJ02B-3PGS-3X	Hi-Vis Green/Black	3X

Radians Type R Class 3 Short Sleeve Safety T-Shirts with Max-Dri™ Mesh Fiber

The ST11-3 Type R Class 3 T-Shirts are made with an arid birdseye mesh allowing for maximum breathability without compromising durability. The stripes are adhered by heat transfer rather than sewn on, making the safety t-shirt wear much more like a regular T-shirt. The wicking properties improve hot weather comfort, making it feel much cooler.

FEATURES & BENEFITS

- Max-Dri moisture wicking mesh technology helps keep you cool
- 2" vertical and horizontal heat transfer, stretchable reflective tape stripes
- One upper left front pocket
- 25 washes max



CERTIFICATIONS

- Meets ANSI/ISEA 107 and Type R/Class 3

C&M PART #	MFG PART #	COLOR	SIZE
10009480MD	ST11-3PGS-M	Hi-Vis Green	M
10009480LG	ST11-3PGS-L	Hi-Vis Green	L
10009480XL	ST11-3PGS-XL	Hi-Vis Green	XL
100094802X	ST11-3PGS-2X	Hi-Vis Green	2X
100094803X	ST11-3PGS-3X	Hi-Vis Green	3X
10009481MD	ST11-3POS-M	Hi-Vis Orange	M
10009481LG	ST11-3POS-L	Hi-Vis Orange	L
10009481XL	ST11-3POS-XL	Hi-Vis Orange	XL
100094812X	ST11-3POS-2X	Hi-Vis Orange	2X
100094813X	ST11-3POS-3X	Hi-Vis Orange	3X

Radians Type R Class 2 Short Sleeve Black Bottom Safety T-Shirts with Max-Dri™ Mesh Fiber

The ST11B Type R Class 2 T-Shirts are made with an arid birdseye mesh allowing for maximum breathability without compromising durability. The stripes are adhered by heat transfer rather than sewn on, making the safety t-shirt feel much more like a regular T-shirt. The wicking properties improve hot weather comfort, making it feel much cooler.

FEATURES & BENEFITS

- Max-Dri moisture wicking mesh technology helps keep you cool
- 2" vertical and horizontal heat transfer, stretchable reflective tape stripes
- Color blocking at the bottom front
- One upper left front pocket
- 25 washes max



CERTIFICATIONS

- Meets ANSI/ISEA 107 and Type R/Class 2

C&M PART #	MFG PART #	COLOR	SIZE
10017478MD	ST11B-2PGS-M	Hi-Vis Green/Black	M
10017478LG	ST11B-2PGS-L	Hi-Vis Green/Black	L
10017478XL	ST11B-2PGS-XL	Hi-Vis Green/Black	XL
100174782X	ST11B-2PGS-2X	Hi-Vis Green/Black	2X
100174783X	ST11B-2PGS-3X	Hi-Vis Green/Black	3X
10017495MD	ST11B-2POS-M	Hi-Vis Orange/Black	M
10017495LG	ST11B-2POS-L	Hi-Vis Orange/Black	L
10017495XL	ST11B-2POS-XL	Hi-Vis Orange/Black	XL
100174952X	ST11B-2POS-2X	Hi-Vis Orange/Black	2X
100174953X	ST11B-2POS-3X	Hi-Vis Orange/Black	3X

Radians Class 2 Short Sleeve Safety Polo Shirts with Max-Dri™ Mesh Fiber

The ST12 Short Sleeve Polo Shirts are made with an arid birdseye mesh allowing for maximum breathability without compromising durability. The stripes are adhered by heat transfer rather than sewn on, making the safety polo shirts extremely comfortable. The wicking properties improve hot weather comfort, making it feel much cooler.

FEATURES & BENEFITS

- Max-Dri moisture wicking mesh technology helps keep you cool
- 2" vertical and horizontal heat transfer, stretchable reflective tape stripes
- One upper left front pocket
- Collar with 2 buttons
- 25 washes max

CERTIFICATIONS

- Meets ANSI/ISEA 107 and Class 2



RADIANS

C&M PART #	MFG PART #	COLOR	SIZE
10067180MD	ST12-2PGS-M	Hi-Vis Green	M
10067180LG	ST12-2PGS-L	Hi-Vis Green	L
10067180XL	ST12-2PGS-XL	Hi-Vis Green	XL
100671802X	ST12-2PGS-2X	Hi-Vis Green	2X
100671803X	ST12-2PGS-3X	Hi-Vis Green	3X
10067181MD	ST12-2POS-M	Hi-Vis Orange	M
10067181LG	ST12-2POS-L	Hi-Vis Orange	L
10067181XL	ST12-2POS-XL	Hi-Vis Orange	XL
100671812X	ST12-2POS-2X	Hi-Vis Orange	2X
100671813X	ST12-2POS-3X	Hi-Vis Orange	3X

Radians Class 2 Long Sleeve Safety Polo Shirts with Max-Dri™ Mesh Fiber

The ST22 Long Sleeve Polo Shirts are made with an arid birdseye mesh allowing for maximum breathability without compromising durability. The stripes are adhered by heat transfer rather than sewn on, making the safety polo shirts extremely comfortable. The wicking properties improve hot weather comfort, making it feel much cooler.

FEATURES & BENEFITS

- Max-Dri moisture wicking mesh technology helps keep you cool
- 2" vertical and horizontal heat transfer, stretchable reflective tape stripes
- One upper left front pocket
- Collar with 2 buttons
- 25 washes max

CERTIFICATIONS

- Meets ANSI/ISEA 107 and Class 2



RADIANS

C&M PART #	MFG PART #	COLOR	SIZE
10018880MD	ST22-2PGS-M	Hi-Vis Green	M
10018880LG	ST22-2PGS-L	Hi-Vis Green	L
10018880XL	ST22-2PGS-XL	Hi-Vis Green	XL
100188802X	ST22-2PGS-2X	Hi-Vis Green	2X
100188803X	ST22-2PGS-3X	Hi-Vis Green	3X
10018881MD	ST22-2PGS-M	Hi-Vis Orange	M
10018881LG	ST22-2PGS-L	Hi-Vis Orange	L
10018881XL	ST22-2PGS-XL	Hi-Vis Orange	XL
100188812X	ST22-2PGS-2X	Hi-Vis Orange	2X
100188813X	ST22-2PGS-3X	Hi-Vis Orange	3X

Radians Type R Class 3 Long Sleeve Black Bottom Safety T-Shirts

The ST21B T-Shirts are made with an arid birdseye mesh allowing for maximum breathability without compromising durability. The stripes are adhered by heat transfer rather than sewn on, making the safety t-shirt wear much more like a regular t-shirt. Reflective stripes on the sleeves provide added visibility. The wicking properties improve hot weather comfort, making it feel much cooler.

FEATURES & BENEFITS

- Max-Dri moisture wicking mesh technology helps keep you cool
- 2" vertical and horizontal heat transfer, stretchable reflective tape stripes
- Color blocking at the bottom front
- One upper left front pocket
- 25 washes max



RADIANS

CERTIFICATIONS

- Meets ANSI/ISEA 107 and Type R, Class 3

C&M PART #	MFG PART #	COLOR	SIZE
10046578MD	ST21B-3PGS-M	Hi-Vis Green/Black	M
10046578LG	ST21B-3PGS-L	Hi-Vis Green/Black	L
10046578XL	ST21B-3PGS-XL	Hi-Vis Green/Black	XL
100465782X	ST21B-3PGS-2X	Hi-Vis Green/Black	2X
100465783X	ST21B-3PGS-3X	Hi-Vis Green/Black	3X
10046595MD	ST21B-3POS-M	Hi-Vis Orange/Black	M
10046595LG	ST21B-3POS-L	Hi-Vis Orange/Black	L
10046595XL	ST21B-3POS-XL	Hi-Vis Orange/Black	XL
100465952X	ST21B-3POS-2X	Hi-Vis Orange/Black	2X
100465953X	ST21B-3POS-3X	Hi-Vis Orange/Black	3X

Radians Type R Class 3 Heavy-Duty Rip Stop Waterproof & Breathable Pants with Bib

The RW32-EZ1Y Heavy-Duty Pants with Bib with Reflectivz® waterproof and high visibility technology is certified Class E. The 300 denier polyurethane (PU) coated, high-visibility rip stop oxford material provides extra durability. The 3M® silver reflective tape ensure worker visibility.



FEATURES & BENEFITS

- 300 denier PU coated rip stop oxford polyester material
- Hook & loop closure over zipper fly
- 2" wide 3M® 8906 silver reflective tape stripes below the knees
- Knee high leg zipper with adjustable cuffs
- Adjustable and removable suspender straps
- Side cargo pockets
- 25 washes max

CERTIFICATIONS

- Meets ANSI/ISEA 107 and Class E, Type R; Waterproof per ANSI 107, 7.5.3 (AATCC 127); breathable per ANSI 107, 7.6 (ASTM E96)

C&M PART #	MFG PART #	COLOR	SIZE
10024180MD	RW32-EZ1Y-M	Hi-Vis Green/Black	M
10024180LG	RW32-EZ1Y-L	Hi-Vis Green/Black	L
10024180XL	RW32-EZ1Y-XL	Hi-Vis Green/Black	XL
100241802X	RW32-EZ1Y-2X	Hi-Vis Green/Black	2X
100241803X	RW32-EZ1Y-3X	Hi-Vis Green/Black	3X

Radians Class E Surveyor Safety Pants

The SP61 Surveyor Safety Pants have a solid top and mesh bottoms to help you stay cool. The reflective stripes on contrasting trim help make you much more noticeable in low light and broad daylight. Zipper closures along both legs mean you don't have to take off your boots to put these pants on. Front slash pockets provide easy access to your original clothing.



FEATURES & BENEFITS

- 100% polyester mesh bottom and 100% polyester solid top
- 2" silver tape reflective material with two-tone contrasting trim
- Two upper slash pockets go through to your clothing
- Two back pockets
- Full length zipper on both legs

CERTIFICATIONS

- Meets ANSI/ISEA 107 and Class E

C&M PART #	MFG PART #	COLOR	SIZE
10029180LG	SP61-EPGS-ML	Hi-Vis Green	M/L
100291802X	SP61-EPGS-XL2X	Hi-Vis Green	XL/2X
100291804X	SP61-EPGS-3X4X	Hi-Vis Green	3X/4X
10029181LG	SP61-EPOS-ML	Hi-Vis Orange	M/L
100291812X	SP61-EPOS-XL2X	Hi-Vis Orange	XL/2X
100291814X	SP61-EPOS-3X4X	Hi-Vis Orange	3X/4X

Radians Class 3 Three-in-One Safety Weatherproof Parkas with Removable Fleece Jacket

The SJ41 wind- and water-resistant Three-In-One Weatherproof Parkas come with a removable inner fleece jacket with lined sleeves for added warmth and protection. Wrist cuffs with closure help keep the cold out. The hi-vis polyurethane (PU) coated oxford polyester weatherproof shell is durable and easily visible in low light and broad daylight. The safety jacket has zippered pockets and pass through on back for fall protection.



FEATURES & BENEFITS

- Removable inner fleece jacket with lined sleeves for easy removal
- 2" vertical and horizontal silver reflective tape stripes
- Mic tabs on both shoulders
- Four lower fleece lined pockets with zipper
- Concealed attached hood
- D-Ring pass through on back for fall protection
- 25 washes max

CERTIFICATIONS

- Class 3
- ANSI/ISEA 107

C&M PART #	MFG PART #	COLOR	SIZE
10040878MD	SJ410B-3ZGS-M	Hi-Vis Green/Black	M
10040878LG	SJ410B-3ZGS-L	Hi-Vis Green/Black	L
10040878XL	SJ410B-3ZGS-XL	Hi-Vis Green/Black	XL
100408782X	SJ410B-3ZGS-2X	Hi-Vis Green/Black	2X
100408783X	SJ410B-3ZGS-3X	Hi-Vis Green/Black	3X

Radians Type R Class 2/3 Four-in-One Reversible Safety Windbreakers with Zip-Off Sleeves

These SJ07-3ZDS Four-in-One Reversible Windbreakers with Zip-Off Sleeves provide superior, cross-seasonal comfort and weather protection. Wear the windbreaker as a Class 3 hi-vis jacket or take off the sleeves to convert to a Class 2 hi-vis vest. Simply reverse the windbreaker to wear as a dark, low-profile gray jacket or vest. The gray side features high-visibility reflective piping.



FEATURES & BENEFITS

- Removable, zippered sleeves—easily converts jacket to vest
- Heavy-duty #5 zipper closure
- 2" vertical and horizontal silver reflective tape stripes (hi-vis side only)
- Reflective hi-vis 1/8" piping along back insert, yoke seams and zipper (gray side only)
- Hemmed elastic sleeves
- Adjustable bottom hem using bungee cord and toggles
- Garment passes AATCC35 rain test
- 2" drop tail back
- 25 washes max

CERTIFICATIONS

- Meets ANSI 107 and Type R/Class 3 or Class 2

C&M PART #	MFG PART #	COLOR	SIZE
10027278MD	SJ07-3ZDS-M	Hi-Vis Green	M
10027278LG	SJ07-3ZDS-L	Hi-Vis Green	L
10027278XL	SJ07-3ZDS-XL	Hi-Vis Green	XL
100272782X	SJ07-3ZDS-2X	Hi-Vis Green	2X
100272783X	SJ07-3ZDS-3X	Hi-Vis Green	3X

Radians Class 3 Deluxe Three-in-One Safety Bomber Jackets with Removable Fleece Jacket

The SJ210B Three-in-One Deluxe Bomber Jackets with black bottom come with a zip out fleece jacket with lined sleeves, concealed attached hood and elasticized waistband for added warmth. The hi-vis polyurethane (PU) coated oxford polyester weatherproof shell is durable and easily visible in low light and broad daylight.



FEATURES & BENEFITS

- Zip out removable fleece jacket with lined sleeves for easy removal
- 2" vertical and horizontal silver reflective tape stripes
- Concealed attached hood
- Include zippered fleece lined slash pockets, cell phone/radio chest pockets and clear chest badge holder
- Mic tabs on both shoulders
- 25 washes max

CERTIFICATIONS

- Meets ANSI/ISEA 107 and Type R/Class 3

C&M PART #	MFG PART #	COLOR	SIZE
10013078MD	SJ210B-3ZGS-M	Hi-Vis Green/Black	M
10013078LG	SJ210B-3ZGS-L	Hi-Vis Green/Black	L
10013078XL	SJ210B-3ZGS-XL	Hi-Vis Green/Black	XL
100130782X	SJ210B-3ZGS-2X	Hi-Vis Green/Black	2X
100130783X	SJ210B-3ZGS-3X	Hi-Vis Green/Black	3X
10013095MD	SJ210B-3ZOS-M	Hi-Vis Orange/Black	M
10013095LG	SJ210B-3ZOS-L	Hi-Vis Orange/Black	L
10013095XL	SJ210B-3ZOS-XL	Hi-Vis Orange/Black	XL
100130952X	SJ210B-3ZOS-2X	Hi-Vis Orange/Black	2X
100130953X	SJ210B-3ZOS-3X	Hi-Vis Orange/Black	3X

NEED HELP FINDING AN ITEM?

SHOP CORE & MAIN SUPPLY



Core & Main has access to thousands of products from hundreds of suppliers.

Check out our full assortment of products and suppliers online at supply.coreandmain.com or speak with one of our customer service representatives at **1-888-885-2673**.



Radians Class 3 Multi-Color Weatherproof Bomber Jackets with Built-in Quilted Liner

The SJ12 Weatherproof Multi-Color Bomber Jackets feature a smooth and plush quilted liner that makes it very easy to slip on and off over fleece or other warm outwear. The hi-vis polyurethane (PU) coated 300 denier oxford polyester weatherproof shell is durable and easily visible in low light and broad daylight.



FEATURES & BENEFITS

- 160 g/m2 quilted liner adds warmth
- 2" vertical and horizontal silver reflective tape stripes
- Concealed detachable hood
- Elastic waistband and cuffs
- Zippered, lined slash pockets and 3D flap covered cell phone/radio chest pocket
- Mic tabs on both shoulders
- 25 washes max

CERTIFICATIONS

- Meets ANSI/ISEA 107 and Class 3

C&M PART #	MFG PART #	COLOR	SIZE
10043987MD	SJ12-3ZMS-M	Hi-Vis Green/Hi-Vis Orange	M
10043987LG	SJ12-3ZMS-L	Hi-Vis Green/Hi-Vis Orange	L
10043987XL	SJ12-3ZMS-XL	Hi-Vis Green/Hi-Vis Orange	XL
100439872X	SJ12-3ZMS-2X	Hi-Vis Green/Hi-Vis Orange	2X
100439873X	SJ12-3ZMS-3X	Hi-Vis Green/Hi-Vis Orange	3X

Radians Class 3 High-Visibility Weatherproof Bomber Jackets with Built-in Quilted Liner

The SJ11QB Weatherproof Bomber Jackets feature a smooth and plush quilted liner that makes it very easy to slip on and off over fleece or other warm outwear. The hi-vis polyurethane (PU) coated oxford polyester weatherproof shell is durable and easily visible in low light and broad daylight.



FEATURES & BENEFITS

- 160 g/m2 quilted liner adds warmth
- 2" vertical and horizontal silver reflective tape stripes
- Concealed detachable hood
- Color blocked black bottom
- Elastic waistband and wrist cuffs
- Four pockets, including flap covered radio pocket, zipper closure lined pockets and open chest pocket
- Mic tabs on both shoulders
- 25 washes max

CERTIFICATIONS

- Meets ANSI/ISEA 107 and Class 3

C&M PART #	MFG PART #	COLOR	SIZE
10047980MD	SJ11QB-3ZGS-M	Hi-Vis Green/Black	M
10047980LG	SJ11QB-3ZGS-L	Hi-Vis Green/Black	L
10047980XL	SJ11QB-3ZGS-XL	Hi-Vis Green/Black	XL
100479802X	SJ11QB-3ZGS-2X	Hi-Vis Green/Black	2X
100479803X	SJ11QB-3ZGS-3X	Hi-Vis Green/Black	3X

Radians Type R Class 2/3 Quilted Reversible Four-in-One Jackets with Zip-Off Sleeves

These SJ510 Quilted Four-in-One Reversible Jackets with Zip-Off Sleeves provide superior, cross-seasonal comfort and weather protection. Flip it inside out to reverse from dark, low-profile grey to bright, hi-vis yellow. Hi-vis side features diamond shape ripstop polyester with DWR coating; flip side features gray ripstop polyester with DWR and colorfast coating. Simply unzip the sleeves to convert the Class 3 hi-vis jacket to a Class 2 hi-vis vest.



FEATURES & BENEFITS

- Removable, zippered sleeves—converts jacket to vest
- Heavy-duty #5 zipper closure
- 2" vertical and horizontal silver reflective tape stripes
- Reflective zippers
- 25 washes max

CERTIFICATIONS

- Meets ANSI/ISEA 107 and Type R, Class 3 (jacket)/Class 2 (vest)

C&M PART #	MFG PART #	COLOR	SIZE
100504MD	SJ510-3ZGS-M	Hi-Vis Green/Black	M
100504LG	SJ510-3ZGS-L	Hi-Vis Green/Black	L
100504XL	SJ510-3ZGS-XL	Hi-Vis Green/Black	XL
1005042X	SJ510-3ZGS-2X	Hi-Vis Green/Black	2X
1005043X	SJ510-3ZGS-3X	Hi-Vis Green/Black	3X

Radians Class 3 Two-in-One Safety Bomber Jackets with Removable Fleece Lining

The SJ110B Two-in-One Bomber Jackets with black bottom have a zip out removable fleece lining and fleece collar for added warmth. Zip out fleece liner with lined sleeves are easy to put on and take off. The hi-vis polyurethane (PU) coated polyester weather-resistant shell is durable and easily visible in low light and broad daylight.



CERTIFICATIONS

- Meets ANSI/ISEA 107 and Class 3

C&M PART #	MFG PART #	COLOR	SIZE
10038878MD	SJ110B-3ZGS-M	Hi-Vis Green/Black	M
10038878LG	SJ110B-3ZGS-L	Hi-Vis Green/Black	L
10038878XL	SJ110B-3ZGS-XL	Hi-Vis Green/Black	XL
100388782X	SJ110B-3ZGS-2X	Hi-Vis Green/Black	2X
100388783X	SJ110B-3ZGS-3X	Hi-Vis Green/Black	3X
10038895MD	SJ110B-3ZOS-M	Hi-Vis Orange/Black	M
10038895LG	SJ110B-3ZOS-L	Hi-Vis Orange/Black	L
10038895XL	SJ110B-3ZOS-XL	Hi-Vis Orange/Black	XL
100388952X	SJ110B-3ZOS-2X	Hi-Vis Orange/Black	2X
100388953X	SJ110B-3ZOS-3X	Hi-Vis Orange/Black	3X



FEATURES & BENEFITS

- Zip out removable fleece liner with lined sleeves for easy removal
- 2" vertical and horizontal silver reflective tape stripes
- Concealed attached hood
- Black knit waistband and cuffs
- Seven pockets, including cell phone/radio chest pocket and slotted pencil pocket
- Mic tabs on both shoulders
- 25 washes max

Radians® ERW™ 35 Economy Rainsuits

Wear ERW 35 Economy Rainwear to stay dry in the rain or keep from getting dirty. The PVC exterior and POLY interior create added stability between layers for industrial strength at an affordable price. The three-piece rainsuit includes a jacket, bib overalls and hood. This bib is ideal for environmental cleanup, general construction, shipyards and general maintenance. Use this jacket for short-term protection from environmental or weather-related conditions.

FEATURES & BENEFITS

- 0.35mm PVC/POLY three-piece rainsuit include jacket, bib overall and detachable hood
- Fold down collar
- Snap front closure
- Lower front pockets with flaps
- Double heat-welded seam construction
- Snap adjustments on sleeve and leg cuffs

CERTIFICATIONS

- ASTM F903



C&M PART #	MFG PART #	SIZE
100305D7MD	RS01-NSYV-M	M
100305D7LG	RS01-NSYV-L	L
100305D7XL	RS01-NSYV-XL	XL
100305D72X	RS01-NSYV-2X	2X
100305D73X	RS01-NSYV-3X	3X

Radians® Neese Universal 35 Series Suit

The Universal 35 Series Suits are the go-to garments when you need it all. The PVC/nylon/PVC material offers tough, lightweight protection that will not crack or peel even in temperatures down to -30°F or up to 120°F. The Universal 35 gives excellent abrasion, tear and snag resistance. Jacket and bib are sold separately.

FEATURES & BENEFITS

- Nonconductive snap closures with storm flap on the jacket
- Stand-up collar jacket with snaps for detachable hood
- Jacket is minimum 48" long
- Nonconductive snap closures that fasten suspenders on the bib
- Bib front coverage
- Adjustable elastic suspenders

CERTIFICATIONS

- ASTM D6413, NFPA-701, ASTM F903

C&M PART #	MFG PART #	SIZE
JACKETS WITH SNAPS		
100643C2MD	35001-01-1-YEL-M	M
100643C2LG	35001-01-1-YEL-L	L
100643C2XL	35001-01-1-YEL-XL	XL
100643C22X	35001-01-1-YEL-2X	2X
100643C23X	35001-01-2-YEL-3X	3X
BIB TROUSERS		
100146C2MD	35001-12-1-YEL-M	M
100146C2LG	35001-12-1-YEL-L	L
100146C2XL	35001-12-1-YEL-XL	XL
100146C22X	35001-12-1-YEL-2X	2X
100146C23X	35001-12-2-YEL-3X	3X



Radians® RW30 Hi-Viz Green Lightweight Rainwear

The RW30 rainwear with Reflectivz® weatherproof and high visibility technology keeps you cool and comfortable while protecting you in tough environments. The 300 denier polyurethane (PU) coated, high-visibility oxford material provides excellent durability. Reflective tapes on jacket and pants (one horizontal, two vertical, and two sleeve stripes; two horizontal stripes on each leg and one horizontal stripe on waist) ensure the wearer is easily seen. The RW30 rainwear series includes a rain jacket and bib pant—sold separately.

FEATURES & BENEFITS

- 2" wide silver reflective tape ensures easy visibility
- Vented back cape with D-ring pass through for fall protection
- Adjustable cuff wrists with hook & loop closures
- Mic tabs on both shoulders
- Zipper front closure with snap closure storm flap
- Two lower front pockets, upper chest radio pocket and pen pockets on sleeve
- Wash up to 25 times

CERTIFICATIONS

- Jacket: Class 3; Pants: Class E



C&M PART #	MFG PART #	SIZE
RAIN JACKETS		
10060880MD	RW30-3Z1Y-M	M
10060880LG	RW30-3Z1Y-L	L
10060880XL	RW30-3Z1Y-XL	XL
100608802X	RW30-3Z1Y-2X	2X
100608803X	RW30-3Z1Y-3X	3X
BIB PANTS		
10057980MD	RW30-ES1Y-M	M
10057980LG	RW30-ES1Y-L	L
10057980XL	RW30-ES1Y-XL	XL
100579802X	RW30-ES1Y-2X	2X
100579803X	RW30-ES1Y-3X	3X

Radians® Heavy-Duty Rip Stop Waterproof Rainwear

The RW32 Series Heavy-Duty Rainwear features Reflectivz® waterproof and high visibility technology to keep you cool and comfortable while protecting you in tough environments. The 300 denier polyurethane (PU) coated, high-visibility ripstop oxford material provides extra durability. The 3M® silver reflective tape offers added visibility during inclement. The RW32 rainwear series includes a rain jacket and bib pant—sold separately.

FEATURES & BENEFITS

- 2" wide 3M® 8906 silver reflective tape ensures easy visibility
- 2 horizontal, 2 vertical and 2 sleeve stripes
- Cape vented front and back cap with D-ring pass through
- Adjustable elastic sleeve cuffs with hook & loop closure
- Attached stowable hood on jacket
- Mic tabs on both shoulders

CERTIFICATIONS

- Waterproof per ANSI 107, (AATCC 127 2008); breathable per ANSI 107, 7.6 (ASTME96-05)



C&M PART #	MFG PART #	SIZE
RAIN JACKETS		
10051180MD	RW32-3Z1Y-M	M
10051180LG	RW32-3Z1Y-L	L
10051180XL	RW32-3Z1Y-XL	XL
100511802X	RW32-3Z1Y-2X	2X
100511803X	RW32-3Z1Y-3X	3X
BIB PANTS		
10024180MD	RW32-EZ1Y-M	M
10024180LG	RW32-EZ1Y-L	L
10024180XL	RW32-EZ1Y-XL	XL
100241802X	RW32-EZ1Y-2X	2X
100241803X	RW32-EZ1Y-3X	3X

LaCrosse ZXT Insulator III Chest Waders

Heavy duty, waterproof and tear-resistant, the Lacrosse ZXT chest waders feature premium, natural rubber that won't crack in the cold, won't get soft in the heat, and won't ever let you down when you need it most. The fully vulcanized Trac-Lite outsole is extra durable and ensures it won't separate. The full rubber chest wader won't absorb smells, bacteria, or other chemicals.

FEATURES & BENEFITS

- Insulating foam extends from the bottom of the boot to the ankle for added warmth
- Wool felt midsole helps with air circulation and odor control
- Internal rubber reinforcement to the leg and stomach zones for longer wear

CERTIFICATIONS

- ASTM F2892-18 EH

C&M PART #	MFG PART #	DESCRIPTION
10627009	191200	Black, Size 8
10627011	191200	Black, Size 9
10627013	191200	Black, Size 10
10627015	191200	Black, Size 11
10627017	191200	Black, Size 12
10627019	191200	Black, Size 13
10627020	191200	Black, Size 14
10627021	191200	Black, Size 15

REPLACEMENT PARTS & ACCESSORIES

C&M PART #	MFG PART #	DESCRIPTION
106273	908250	LaCrosse H-Back Suspenders



LaCrosse Premium Steel-Toe, Black 16" Knee-High Boots

Lightweight and always long-wearing, these Premium Knee-High Boots feature specially formulated ZXT rubber that won't crack in the cold, won't get soft in the heat and won't ever let you down when you need it most. Steel toes on boots provide added protection when working at job site. Comfortable enough to wear as an everyday work boot, but durable enough to last in the back of the truck for those just-in-case days.



FEATURES & BENEFITS

- Waterproof protection
- Steel toes keep you protected
- Mud, snow and slip resistance
- Tear-resistant rubber
- Arch protection—extra layer of rubber underfoot and around the in-step

CERTIFICATIONS

- EH Rated

C&M PART #	MFG PART #	SIZE (MEN'S)
10627209	00267220-8	8
10627211	00267220-9	9
10627213	00267220-10	10
10627215	00267220-11	11
10627217	00267220-12	12
10627219	00267220-13	13

LaCrosse Alpha Aggressive Steel-Toe, Brown 16" Knee-High Boots

When you're outside and in deep all day, you need a boot that's going to hold up and not let you down. The Alpha Aggressive Boots are made with chemical-resistant rubber that won't break down and ensure complete waterproof protection. The Vibram® outsole is extra durable and offer excellent traction; a fully adjustable rubber gusset provides a perfect fit.



FEATURES & BENEFITS

- Chemical-resistant rubber and neoprene construction offer excellent protection
- Stay dry with waterproof boots
- Steel toes keep you protected
- Oil and slip resistant
- EH rated
- Full-rubber gusset accommodates different calf sizes

CERTIFICATIONS

- ASTM F903

C&M PART #	MFG PART #	SIZE (MEN'S)
10627109	00426040-8	8
10627111	00426040-9	9
10627113	00426040-10	10
10627115	00426040-11	11
10627117	00426040-12	12
10627119	00426040-13	13

LaCrosse Insulated Storm Steel-Toe, Black 31" Hip-High Boots

Lightweight and always long-wearing, these Storm Hip Boots feature specially formulated ZXT rubber that won't crack in the cold, won't get soft in the heat and won't ever let you down when you need it most. With a layer of insulating foam and a wool-felt midsole underfoot, you'll always stay warm in the deepest mud and muck.

FEATURES & BENEFITS

- Waterproof protection
- Steel toes keep you protected
- Tear-resistant rubber
- EH rated
- Mud, snow and slip resistance
- Foam insulation, wool felt midsole and canvas lining for warmth and durability

CERTIFICATIONS

- ASTM F2413-18 I/75 C/75 EH PR

C&M PART #	MFG PART #	SIZE (MEN'S)
10626909	00109050-8	8
10626911	00109050-9	9
10626913	00109050-10	10
10626915	00109050-11	11
10626917	00109050-12	12
10626919	00109050-13	13





NEED SAFETY?

Choose supply.coreandmain.com.



Visit our website and get 24/7 access to the safety products you need in the plant, lab, and field.

Find the heavy-duty and OSHA-approved safety gear you need as a water and wastewater professional working in dangerous areas. Get new and replacement safety equipment with quick & reliable shipping and help from our team of product specialists.

Free shipping over \$1500*.

*\$1500 applies to lower 48 states. \$4500 minimum required for free shipping to Alaska and Hawaii.

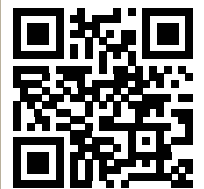

SHOP
CORE & MAIN
SUPPLY

Sampling Equipment



TABLE OF CONTENTS

Hach Samplers & Accessories	376-378
Hach Sampler Parts & Accessories	379
Sludge Samplers	379-380
Sludge, Septic & Grease Samplers	380
Sludge Blanket Detectors	381
Dippers & Grab Samplers	382
Sampling Bags	383
Filter Bed Samplers	383
Sampling Stations	384

Hach AS950 All-Weather Refrigerated Samplers

Designed to withstand extreme environmental conditions, the Hach® AS950 All-Weather Refrigerated Samplers are ideal for collecting samples indoors or outdoors. Low-density polyethylene housing provides excellent weather, corrosion and UV resistance. The sampler base is designed to endure humid and highly corrosive environments, minimizing damage caused by corrosive gases, rodents and standing water to guarantee environmental integrity.

Samplers feature a large, full-color display for intuitive, single-screen programming, USB upload and download capabilities and the ability to copy programs sampler to sampler to save time on tedious programming. An error alert and the program status screen instantly communicates alarms, missed samples and program progress for quick and easy troubleshooting. The custom-designed air-sensing thermostat controls temperature in accordance with US EPA guidelines, preserving samples at 39°F (4°C) regardless of outside temperatures and conditions. Select a sampler bundle with a heater for use in colder temperatures.



FEATURES & BENEFITS

- Designed to endure humid and highly corrosive environments
- Easily view status and program using a large full-color display
- The only sampler that utilizes a USB drive to upload and download data
- Copy programs from one sampler to another to save time and minimize errors

SPECIFICATIONS

OPERATING TEMPERATURE	32 to 122°F (0 to 50°C) Standard -40 to 122°F (-40 to 50°C) with Heater Option
SAMPLE COOLING	1/5 hp, 239°F (115°C) Thermal Overload Protector
MAXIMUM LIFT	28-ft
TRANSPORT VELOCITY	2.9 ft/sec at 15 ft Vertical Lift (Typical)
SAMPLE VOLUME	Programmable in 10-mL Increments from 10 to 10,000 mL
ACCURACY	±3%
SAMPLE MODES	
PACING	Time-fixed, Flow-fixed, Time Variable, Flow Variable, Event-based
DISTRIBUTION	Single-bottle Composite, Multi-bottle Composite, Multi-bottle discrete, Bottles per Sample, Samples per Bottle, Combination of Bottles per Sample/Samples per Bottle
SAMPLE INTERVAL	Single Increments from 1 to 9999 Flow Pulses, 1 to 9999 Minutes in 1-Minute Increments
SAMPLE PROGRAMS	Runs Two Programs Simultaneously, Sequentially or in Parallel
INTERNAL CLOCK	Real Time, Accurate to ±1-Second per Day at 77°F (25°C)
COMMUNICATIONS	USB Port (Modbus RS485 Optional)
USER INTERFACE	Membrane Switch Keypad and VGA Color Display
POWER REQUIREMENTS	115 VAC*, 60 Hz, 4.2 A (6.4 A with Heater) 7.1 A Locked Rotor Current
INPUT TYPES	Flow Pacing or Event Pulse (Contact Closure or 5 to 12 VDC Pulses) 4 to 20 mA
DIMENSIONS (W x H x D)	30" x 51" x 32"
WEIGHT	190 lbs
APPROVALS	CE, UL

*230 VAC Available. Contact Core & Main for More Information

C&M PART #	MFG PART #	DESCRIPTION
703193	ASA.CXXX1X11XX	Sampler Bundle with 1 x 5.5 Gallon Bottle
703195	ASA.CXXX1X31XX	Sampler Bundle with 4 x 2.5 Gallon Bottles
703202	ASA.CXXX2X11XX	Sampler Bundle with Compartment Heater & 1 x 5.5 Gallon Bottle
703203	ASA.CXXX2X21XX	Sampler Bundle with Compartment Heater & 1 x 2.5 Gallon Bottle
703204	ASA.CXXX2X31XX	Sampler Bundle with Compartment Heater & 4 x 2.5 Gallon Bottles

REPLACEMENT PARTS & ACCESSORIES

C&M PART #	MFG PART #	DESCRIPTION
703191	ASA.CXXX	AS950 Basic Controller for All-Weather Refrigerated Sampler
702418	8755500	Desiccant Yellow Refill, 1.5 lb
702419	8755600	Desiccant Assembly for SD900 with Grease
702518	9494500	IO9001 Module, Includes 1 Relay, High Voltage
702519	9494600	IO9004 Module
702522	9501000	Universal Junction Box for 4 to 20 mA
702376	8528500	Aux Half Cable, 7-Pin, 9-ft Length
702377	8528501	Cable, 7-Pin, 25-ft Length
702259	5698200	AC Power Backup for All Weather & Portable Samplers
702883	4600-15	Silicone Pump Tubing, 3/8" ID, 15-ft Length
702884	4600-50	Silicone Pump Tubing, 3/8" ID, 50-ft Length
700468	920	Vinyl Tubing, Intake, 3/8" ID, 25-ft Length
700471	923	Vinyl Tubing, Intake, 3/8" ID, 100-ft Length
700472	924	Vinyl Tubing, Intake, 3/8" ID, 500-ft Length
700469	921	PTFE Lined Polyethylene Tubing, 3/8" ID, 10-ft Length
700470	922	PTFE Lined Polyethylene Tubing, 3/8" ID, 7-m Length
700473	925	PTFE Lined Polyethylene Tubing, 3/8" ID, 100-ft Length
700500	2186	PTFE Lined Polyethylene Tubing Connection Kit
700474	926	PTFE/Stainless Steel Strainer, 5-1/2"L
700497	1918	Polyethylene Bottle with Cap, 2.5 Gallon
700505	2315	Polyethylene Bottles with Cap, 2.5 Gallon, Set of Four
700532	6494	Polyethylene Bottle with Cap, 5.5 Gallon

Hach AS950 Series Indoor Refrigerated Samplers

The Hach® AS950 Refrigerated Samplers take samples from your effluent stream and maintain them at 39°F (4°C). The 22-gauge steel with vinyl laminate overcoating makes these samplers perfect for indoor use. The sampler base is designed to endure humid and highly corrosive environments, minimizing damage caused by corrosive gases, rodents and standing water to guarantee environmental integrity.

Samplers feature a large, full-color display for intuitive, single-screen programming, USB upload and download capabilities and the ability to copy programs sampler to sampler to save time on tedious programming. An error alert and the program status screen instantly communicates alarms, missed samples and program progress for quick and easy troubleshooting. The custom-designed air-sensing thermostat controls temperature in accordance with US EPA guidelines, preserving samples regardless of outside temperatures and conditions.



FEATURES & BENEFITS

- Base designed to endure humid and highly corrosive environments
- Easily view status and program using a large full-color display
- The only sampler that utilizes a USB drive to upload and download data
- Copy programs from one sampler to another to save time and minimize errors

SPECIFICATIONS

TEMPERATURE LIMITS	32 to 120°F (0 to 49°C)
SAMPLE COOLING	1/7 hp, 75W, 400 BTU/Hr. Compressor, 230°F (110°C) Thermal Overload Protector
MAXIMUM LIFT	28-ft.
TRANSPORT VELOCITY	2.9 ft/sec at 15 ft Vertical Lift (Typical)
SAMPLE VOLUME	Programmable in 10-mL Increments from 10 to 10,000 mL
ACCURACY	±3%
REPEATABILITY	±5%
SAMPLE MODES	
PACING	Time-fixed, Flow-fixed, Time Variable, Flow Variable, Event-based
DISTRIBUTION	Single-bottle Composite, Multi-bottle Composite, Multi-bottle discrete, Bottles per Sample, Samples per Bottle, Combination of Bottles per Sample/Samples per Bottle
SAMPLE INTERVAL	Single Increments from 1 to 9999 Flow Pulses, 1 to 9999 Minutes in 1-Minute Increments
SAMPLE PROGRAMS	Runs Two Programs Simultaneously, Sequentially or in Parallel
INTERNAL CLOCK	Real Time, Accurate to ±1-Second per Day at 77°F (25°C)
COMMUNICATIONS	USB Port (Modbus RS485 Optional)
USER INTERFACE	Membrane Switch Keypad and VGA Color Display
POWER REQUIREMENTS	115 VAC*, 60 Hz, 1.5 to 2A Running, 12A Locked Rotor Current
INPUT TYPES	Flow Pacing or Event Pulse (Contact Closure or 5 to 12 VDC Pulses) 4 to 20 mA
DIMENSIONS (W x H x D)	24" x 44" x 24"
WEIGHT	140 lbs
APPROVALS	CE, UL

*230 VAC Available. Contact Core & Main for More Information

C&M PART #	MFG PART #	DESCRIPTION
703251	ASR.CXXX1X11XX	Sampler Bundle with 1 x 5.5 Gallon Bottle
703253	ASR.CXXX1X21XX	Sampler Bundle with 1 x 2.5 Gallon Bottle
703254	ASR.CXXX1X31XX	Sampler Bundle with 4 x 2.5 Gallon Bottles

REPLACEMENT PARTS & ACCESSORIES

C&M PART #	MFG PART #	DESCRIPTION
703191	ASA.CXXX	AS950 Basic Controller for All-Weather Refrigerated Sampler
702418	8755500	Desiccant Yellow Refill, 1.5 lb
702419	8755600	Desiccant Assembly for SD900 with Grease
702518	9494500	IO9001 Module, Includes 1 Relay, High Voltage
702519	9494600	IO9004 Module
702522	9501000	Universal Junction Box for 4 to 20 mA
702376	8528500	Aux Half Cable, 7-Pin, 9-ft Length
702377	8528501	Cable, 7-Pin, 25-ft Length
702259	5698200	AC Power Backup for All Weather & Portable Samplers
702883	4600-15	Silicone Pump Tubing, 3/8" ID, 15-ft Length
702884	4600-50	Silicone Pump Tubing, 3/8" ID, 50-ft Length
700468	920	Vinyl Tubing, Intake, 3/8" ID, 25-ft Length
700471	923	Vinyl Tubing, Intake, 3/8" ID, 100-ft Length
700472	924	Vinyl Tubing, Intake, 3/8" ID, 500-ft Length
700469	921	PTFE Lined Polyethylene Tubing, 3/8" ID, 10-ft Length
700470	922	PTFE Lined Polyethylene Tubing, 3/8" ID, 7-m Length
700473	925	PTFE Lined Polyethylene Tubing, 3/8" ID, 100-ft Length
700500	2186	PTFE Lined Polyethylene Tubing Connection Kit
700474	926	PTFE/SS Strainer for 3/8" ID Tubing, 5-1/2"L
700497	1918	Polyethylene Bottle with Cap, 2.5 Gallon
700505	2315	Polyethylene Bottles with Cap, 2.5 Gallon, Set of Four
700532	6494	Polyethylene Bottle with Cap, 5.5 Gallon



Hach AS950 Portable Samplers

The Hach® AS950 Portable Samplers are designed for both indoor and outdoor use. Compact models weigh less than 28 lbs and standard models weigh under 35 lbs, samplers are easy to transport where ever you need to take samples.



Samplers feature a large, full-color display for intuitive, single-screen programming, USB upload and download capabilities and the ability to copy programs sampler to sampler to save time on tedious programing. An error alert and the program status screen instantly communicates alarms, missed samples and program progress for quick and easy troubleshooting.

FEATURES & BENEFITS

- Designed for accuracy and convenience
- Easily view status and program using a large full-color display
- The only sampler that utilizes a USB drive to upload and download data
- Copy programs from one sampler to another to save time and minimize errors

SPECIFICATIONS

OPERATING TEMPERATURE	32 to 120°F (0 to 49°C)
SAMPLE COOLING	Double-walled Insulated Base (Direct Bottle Contact from User-supplied Ice)
MAXIMUM LIFT	28-ft.
TRANSPORT VELOCITY	2.9 ft/sec at 15-ft Vertical Lift (Typical)
SAMPLE VOLUME	Programmable in 10-mL Increments from 10 to 10,000 mL
ACCURACY	±3%
REPEATABILITY	±5%
SAMPLE MODES	
PACING	Time-fixed, Flow-fixed, Time Variable, Flow Variable, Event-based
DISTRIBUTION	Single-bottle Composite, Multi-bottle Composite, Multi-bottle discrete, Bottles per Sample, Samples per Bottle, Combination of Bottles per Sample/Samples per Bottle
SAMPLE INTERVAL	Single Increments from 1 to 9999 Flow Pulses, 1 to 9999 Minutes in 1-Minute Increments
SAMPLE PROGRAMS	Runs Two Programs Simultaneously, Sequentially or in Parallel
INTERNAL CLOCK	Real Time, Accurate to ±1-Second per Day at 77°F (25°C)
COMMUNICATIONS	USB Port (Modbus RS485 Optional)
USER INTERFACE	Membrane Switch Keypad and VGA Color Display
POWER REQUIREMENTS	12 VDC (2.25A Avg.) Supplied by Optional 115 VAC* Power Converter or 7-Ah 12-VDC Battery
INPUT TYPES	Flow Pacing or Event Pulse (Contact Closure or 5-12 VDC Pulses) 4 to 20 mA
DIMENSIONS (W x H)	Compact: 17-3/8" x 25-1/8" Standard: 19-7/8" x 28-3/16"
WEIGHT	Compact: 27 to 28 lbs Standard: 32 to 35 lbs
APPROVALS	CE, UL

*230 VAC Available. Contact Core & Main for More Information



C&M PART #	MFG PART #	DESCRIPTION
AS950 COMPACT PORTABLE SAMPLERS		
703222	ASP.CSXXC12113	Compact Sampler Bundle, Submerged AV & Digital pH Sensor
703227	ASP.CXXXC121XX	Compact Sampler Bundle with 1 x 2.5 Gallon Bottle, 12 VDC
703228	ASP.CXXXC161XX	Compact Sampler Bundle with 24 x 575 mL Bottles, 12 VDC
703230	ASP.CXXXC221XX	Compact Sampler Bundle with 1 x 2.5 Gallon Bottle, 115 VAC
703231	ASP.CXXXC261XX	Compact Sampler Bundle with 24 x 575 mL Bottles, 115 VAC
AS950 STANDARD PORTABLE SAMPLERS		
703235	ASP.CXXXS121XX	Standard Sampler Bundle with 1 x 2.5 Gallon Bottle, 12 VDC
703236	ASP.CXXXS141XX	Standard Sampler Bundle with 24 x 1 L Bottles, 12 VDC
703240	ASP.CXXXS221XX	Standard Sampler Bundle with 1 x 2.5 Gallon Bottle, 115 VAC
703241	ASP.CXXXS241XX	Standard Sampler Bundle with 24 x 1 L Bottles, 115 VAC

REPLACEMENT PARTS & ACCESSORIES

C&M PART #	MFG PART #	DESCRIPTION
703226	ASP.CXXX	AS950 Basic Controller for Portable Sampler
702418	8755500	Desiccant Yellow Refill, 1.5 lb
702419	8755600	Desiccant Assembly for SD900 with Grease
702518	9494500	IO9001 Module, Includes 1 Relay, High Voltage
702519	9494600	IO9004 Module
702522	9501000	Universal Junction Box for 4 to 20mA
702376	8528500	Aux Half Cable, 7-Pin, 9-ft Length
702377	8528501	Cable, 7-Pin, 25-ft Length
703069	8754500US	Power Supply with 3-Pin Connector, 115 VAC, US Plug
702417	8754400	12 Volt Lead Acid Battery with 3-Pin Connector
703068	8753500US	Charger Assembly, L-Acid 3-Pin, 115 VAC, US Plug
702883	4600-15	Silicone Pump Tubing, 3/8" ID, 15-ft Length
702884	4600-50	Silicone Pump Tubing, 3/8" ID, 50-ft Length
700468	920	Vinyl Tubing, Intake, 3/8" ID, 25-ft Length
700471	923	Vinyl Tubing, Intake, 3/8" ID, 100-ft Length
700472	924	Vinyl Tubing, Intake, 3/8" ID, 500-ft Length
700469	921	PTFE Lined Polyethylene Tubing, 3/8" ID, 10-ft Length
700470	922	PTFE Lined Polyethylene Tubing, 3/8" ID, 7-m Length
700473	925	PTFE Lined Polyethylene Tubing, 3/8" ID, 100-ft Length
700500	2186	PTFE Lined Polyethylene Tubing Connection Kit
700474	926	PTFE/SS Strainer for 3/8" ID Tubing
700497	1918	Polyethylene Bottle with Cap, 2.5 Gallon
700505	2315	Polyethylene Bottles with Cap, 2.5 Gallon, Set of Four
700532	6494	Polyethylene Bottle with Cap, 5.5 Gallon
702260	5713000	Manhole Support Bracket for Portable Sampler, 18 to 27"
700556	9557	Manhole Support Bracket/Spanner, 28 to 48"

Hach Sampler Parts & Accessories



C&M PART #	MFG PART #	DESCRIPTION
DESICCANT		
702418	8755500	Change to Desiccant Yellow Refill, 1.5 lb
TUBING		
702883	4600-15	Silicone Pump Tubing, 3/8" ID, 15-ft Length
702884	4600-50	Silicone Pump Tubing, 3/8" ID, 50-ft Length
700469	921	PTFE Lined Polyethylene Tubing, 3/8" ID, 10-ft Length
700470	922	PTFE Lined Polyethylene Tubing, 3/8" ID, 7-m Length
700473	925	PTFE Lined Polyethylene Tubing, 3/8" ID, 100-ft Length
700500	2186	PTFE Lined Polyethylene Tubing Connection Kit
STRAINERS		
700467	903	PTFE/Stainless Steel Strainer, 11"L
700474	926	PTFE/Stainless Steel Strainer, 5-1/2"L
700526	4652	Stainless Steel Strainer for High Velocity/Shallow Depth Applications, 3.9"L
HARNES & BRACKETS		
700483	1355	Portable Sampler Suspension Harness
702260	5713000	Manhole Support Bracket for Portable Sampler, 18 to 27"
700556	9557	Manhole Support Bracket/Spanner, 28 to 48"
BOTTLES		
700497	1918	Polyethylene Bottle with Cap, 2.5 Gallon
700505	2315	Polyethylene Bottles with Cap, 2.5 Gallon, Set of Four
700532	6494	Polyethylene Bottle with Cap, 5.5 Gallon

Sludge Judge Core Samplers



Take accurate readings of settleable solids, 5% or less to any depth with these Sludge Judge Samplers by Nasco Sampling. Samplers are ideal for sewage treatment plants, chemical plants and food processing facilities—anywhere accurate sample levels of settleable solids in noncaustic materials are needed. Each sampler is constructed of durable butyrate tube; a 1-ft (0.31 m) marker on the tubing helps identify the amount of sludge in the tank.

Each sampler measures 15 ft tall and comes in 5 ft (1.53 m) sections of plastic pipe with screw-type connectors. The top section includes a nylon rope for raising and lowering the sampler. Simply add on additional extension section to achieve the desired length.

Sludge Judge features a 3/4" diameter tube and holds approximately 3 oz per foot. This model has red foot markers and black fittings.

Sludge Judge II features a 1-1/4" diameter tube and holds approximately 6 oz per foot. This model has red foot markers and white fittings.

Sludge Judge Ultra features a 3/4" diameter tube and holds approximately 3 oz per foot. The tube is treated with an ultraviolet stabilizer to inhibit deterioration from the sun and is more durable in cold temperatures. This model has blue foot markers and black fittings.

C&M PART #	MFG PART #	DESCRIPTION
704784	C09247	Sludge Judge
704702	B01355	Sludge Judge II, Large Capacity
704705	B01386	Sludge Judge Ultra

REPLACEMENT PARTS & ACCESSORIES

C&M PART #	MFG PART #	DESCRIPTION
704788	C09252	Sludge Judge Top Section with Rope, 5 ft long
704787	C09251	Sludge Judge Extension Section, 5 ft long
704786	C09250	Sludge Judge Bottom Section with Valve, 5 ft long
704703	B01358	Sludge Judge II Top Section with Rope, 5 ft long
704701	B01357	Sludge Judge II Extension Section, 5 ft long
704704	B01356	Sludge Judge II Bottom Section with Valve, 5 ft long
704708	B01387	Sludge Judge Ultra Top Section with Rope, 5 ft long
704707	B01388	Sludge Judge Ultra Extension Section, 5 ft long
704706	B01389	Sludge Judge Ultra Bottom Section with Valve, 5 ft long
704785	C09249	Case for Sludge Judge, Sludge Judge II or Sludge Judge Ultra
704695	B01291	Cleaning Brush, 6 ft L x 1" Diameter Bristle

Sampling Equipment

Sludge Samplers | Sludge, Septic & Grease Samplers

Raven CORETAKER® Sludge Samplers

The Raven CORETAKER Sludge Samplers are built to withstand the rigors of routine usage. Constructed of UV-stable polycarbonate tube, UV-stable UHMW black polyethylene fittings and 100% leakproof couplings, samplers provide long service life while taking accurate samples. It even floats if accidentally dropped into a basin. Uniquely engineered non-threaded slip-lock couplings ensure there are no “bottle neck” restrictions while also adding durability.

To use, simply lower the sampler into a tank. A check valve automatically opens to allow liquid to enter then automatically shuts when the unit is raised from the tank. Easily view the cross-section of the clarifier from top to bottom through a clear polycarbonate tube. Measure and examine the settled sludge for color. Use the Raven Process Centrifuge to evaluate sludge concentration.

The CORETAKER sludge sampler will become an indispensable part of workflows for: determining primary and secondary clarifier sludge blanket thickness and color; retrieving samples from secondary clarifiers to measure Clarifier Sludge Concentration (CSC); or calculating sludge inventory, detention time, and return sludge flow adjustments.

FEATURES & BENEFITS

- Yellow numbered markers indicate sample depth
- Sampler floats if accidentally dropped in water
- Black UV-stable plastic components withstand solar rays
- Slip-Lock coupler will not break and has a unique quick assembly and disassembly design
- Internal O-ring seals prevent leakage and “head drips”

C&M PART #	MFG PART #	DESCRIPTION
700446	B-10104-8	Sampler, 8 ft (2.4 m), 1 Piece
700447	B-10104-16	Sampler, 16 ft (4.9 m), 2 Pieces
700451	B-10104-24	Sampler, 24 ft (7.3 m), 3 Pieces

REPLACEMENT PARTS & ACCESSORIES

C&M PART #	MFG PART #	DESCRIPTION
700450	B-10104-TOP	Sampler Top Section with Lanyard
700449	B-10104-MIDDLE	Sampler Middle Section with Coupler
700448	B-10104-BOTTOM	Sampler Bottom Section with Valve



Raven CORETAKER® MAX Septic Tank Samplers

The Raven CORETAKER MAX easily takes up the heaviest sludge from septic tanks, grease traps, waste oil collections or any place that deals with heavy settled solids. Clear 1-1/2" OD polycarbonate tube offers durability as well as lets you view your sample. Large interior cavity ensures maximum flow through. Link release valve closes when the sampler is full and two internal O-rings on the check valve prevent leaks and sample loss.

FEATURES & BENEFITS

- Huge interior cavity offers maximum flow through
- Link release mega valve provides maximum control
- Stainless steel fasteners withstand various chemicals, grease and oil
- Polycarbonate tube with UV stabilizer inhibit oxidation for longer life



C&M PART #	MFG PART #	DESCRIPTION
700452	B-40404-5	Sludge Sampler, 5 ft (1.5 m)
700453	B-40404-8	Sludge Sampler, 8 ft (2.4 m)

DISPOSABLE SAFETY GLOVES

Looking for personal protective equipment to use while collecting samples?

Take a look at our **Safety** section.

We have different types of disposable gloves starting on **page 334**.



Raven Sludge Interface Detector & Accessories



The Raven Sludge Interface Detector is a portable handheld instrument that accurately determines the sludge blanket solid/liquid interface depth in primary tanks, clarifiers, sedimentation basins, lagoons and a wide variety of tanks with settled sludge and solids. The unit is equipped with a strain relieved signal cable with 1-ft increment depth marks and a sensor probe.

Portable, lightweight, and rugged, it's ideal for use in water and wastewater plants and industrial treatment operations that want simple, quick and reliable sludge interface level depth measurements. Instrument is IP66 rated; probe and cable are IP68 rated up to 50 ft (15 m). The unit is powered by six AA batteries, weighs 16 ounces and measures 8"L x 4.5"W x 3.5"D.

INCLUDES

Wall storage mount, cable holders and batteries; 1-year warranty

C&M PART #	MFG PART #	DESCRIPTION
700457	SID-20200-20	Sludge Interface Detector with 20 ft (6 m) Cable
700458	SID-20200-30	Sludge Interface Detector with 30 ft (9 m) Cable
700459	SID-20200-50	Sludge Interface Detector with 50 ft (15 m) Cable

REPLACEMENT PARTS & ACCESSORIES

C&M PART #	MFG PART #	DESCRIPTION
700460	RP-20203-20	Replacement Probe & 20 ft (6 m) Cable
700461	RP-20203-30	Replacement Probe & 30 ft (9 m) Cable
700462	RP-20203-50	Replacement Probe & 50 ft (15 m) Cable



Helpful Tip: Sludge Blanket Monitoring

Measuring the sludge blanket is necessary to prevent blinding the filters in a wastewater treatment plant. Using a sludge interface is a great way to measure sludge being an easier and less messy process. It saves money from repetitively replacing manual samplers and protects operators from potential injury.

Raven SID Rotary Sludge Interface Detector



The Raven SID Rotary Portable Sludge Interface Detector is a portable instrument designed specifically to detect the sludge blanket interface and display the interface elevation with a precision depth counter. A robust protective cage, IP67 rated encased electronics, modular components and a solid stainless steel sensor probe ensure reliability and durability.

Base stations (sold separately) mounted on guard railings provide accurate and repeatable measurements while operators remain contact-free from the fluid medium. Base stations, available in multiple configurations, will mount or adapt to any fixture or guard rail. With a single SID rotary, an operator can service multiple tanks equipped with base stations.

FEATURES & BENEFITS

- Release the probe and reel it in like a fishing reel
- No touching wet surfaces
- Digital counter with backlit display shows sludge elevation in inches or centimeters
- Rail-mounted base stations ensure accurate measurements
- Lightweight and compact to service multiple tanks
- Stainless steel infrared sensor for long-lasting performance

C&M PART #	MFG PART #	DESCRIPTION
700436	S-40100-30	SID Rotary Sludge Interface Detector, 30 ft (9 m) Cable
700437	S-40100-50	SID Rotary Sludge Interface Detector, 50 ft (15 m) Cable
700442	S-40-170	Free Style Handle
700439	S-40-161	T-Rail Base Station and Mounting Hardware
700438	S-40-160	L-Rail Base Station and Mounting Hardware
700440	S-40-162	Round Rail Base Station and Mounting Hardware
700441	S-40-163	Universal Base Station and Mounting Hardware

REPLACEMENT PARTS & ACCESSORIES

C&M PART #	MFG PART #	DESCRIPTION
700461	RP-20203-30	Replacement Probe & 30 ft (9 m) Cable
700462	RP-20203-50	Replacement Probe & 50 ft (15 m) Cable

Whirl-Pak™ Swing Samplers

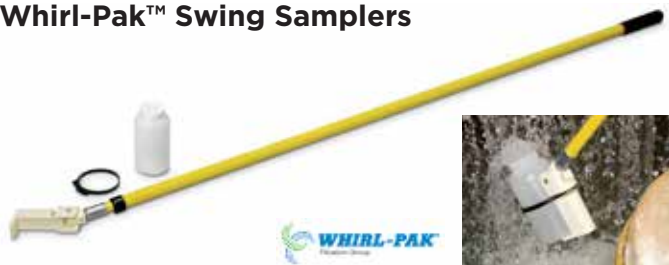

Easily collect samples from a horizontal flowing stream, such as a sewer with the Nasco Swing Samplers. The end of the sampler swings, allowing collection from different angles, including 90 degrees. The 8-ft. adjustable fiberglass pole extends to 12 ft or 24 ft (depending on model) providing a long length for any sampling situation.

A polyurethane bottle holder with a plastic snapper ring and adjustable locking device keeps bottle in place. Other types of bottles may be used but a different type of fastener may be required to hold the bottle in place.

INCLUDES

A 960 mL polyethylene bottle with vinyl lined cover for leak-proof protection; (Accessories are interchangeable with those of the Sludge Nabber C&M PN 704709)

C&M PART #	MFG PART #	DESCRIPTION
704712	B01310	Nasco Sampling Swing Sampler, Extends to 12 ft
704713	B01366	Nasco Sampling Swing Sampler, Extends to 24 ft

REPLACEMENT PARTS & ACCESSORIES

C&M PART #	MFG PART #	DESCRIPTION
704694	B01354	Replacement Bottle Holder Nasco Sampling Swing Samplers
701186	2087083	Nalgene HDPE Sampling Bottles, Low-Density Polyethylene, 1 L, 6/Pk
701174	2087079	Nalgene HDPE Sampling Bottles, Low-Density Polyethylene, 500 mL, 12/Pk
701184	2087076	Nalgene HDPE Sampling Bottles, Low-Density Polyethylene, 250 mL, 12/Pk

Thermo Scientific™ Custody Seals

Use the Thermo Scientific custody seals to securely seal sample bottle. Once sealed, the custody seals cannot be peeled off and the paper label would need to be broken to open the bottle. The seals include an area for writing the custody signature and date for tamper-evident security. These provide complete chain-of-custody and tamper evidence for samples from the point of collection to lab receipt.



ThermoFisher
SCIENTIFIC

C&M PART #	MFG PART #	DESCRIPTION
706607	ICH 500	Custody Seals, 1" x 7", Pack of 100

SP Bel-Art Plastic Economy Dippers



SP Bel-Art

These Economy Dippers are lightweight, easy to use and portable for convenient sampling from tanks, vats, streams, ponds and lakes.

FEATURES & BENEFITS

- Replace polypropylene cup to reduce cross contamination
- Two pouring spouts on cup allow left or right pouring
- Ribbed high-density polyethylene honeycomb tube handles provide a sure grip
- Handle end has a hook for easy hanging storage

C&M PART #	MFG PART #	DESCRIPTION
700324	36784-0016	Plastic Economy Dipper, 3 ft Long Handle
700325	36785-0016	Plastic Economy Dipper, 6 ft Long Handle

REPLACEMENT PARTS & ACCESSORIES

C&M PART #	MFG PART #	DESCRIPTION
700326	36786-0016	Replacement Cup for Plastic Economy Dipper

Nalgene Wide-Mouth HDPE Sampling Bottles



Excellent chemical resistance to most corrosives makes these wide-mouth bottles versatile and indispensable in the lab or field. Ideal for storing, shipping, and packaging liquid. Uniform walls provide durability and resistance to splitting or punctures. The wide-mouth makes it easy to fill and collect samples. Liner less caps provide the ultimate in leakproof protection without the use of liner that can wrinkle, cause leaks, or contaminate your sample.

C&M PART #	MFG PART #	CAPACITY (mL)	QUANTITY
706581	2104-0016	500	12
700198	2104-0032	1000	6

Whirl-Pak® Thio Sterilized Water Sampling Bags



Whirl-Pak Thio Sterilized Bags are shipping and storage containers designed specifically for sampling chlorinated water. These bags contain enough sodium thiosulfate to neutralize chlorine at the time of collection. Bags have a convenient write-on strip to aid in sample identification. Bags go through post-manufacturing sterilization. Available in standard and stand-up bags that eliminate the need for racks and holders.

C&M PART #	MFG PART #	DESCRIPTION	BAGS/BOX
704763	B01040	Thio Bags, 4 oz	100
704761	B01254	Thio Bags, 10 oz	100
704764	B01402	Stand-Up Thio Bags, 4 oz	100
704762	B01403	Stand-Up Thio Bags, 10 oz	100
704765	B01601	Stand-Up Thio Bags, 17 oz	100
704766	B01603	Stand-Up Thio Bags, 34 oz	100

**CHECK US OUT
ONLINE**



We're always adding new products.
Visit supply.coreandmain.com
for our latest additions.

Raven Filter Media Expansion Manager Systems



The Raven Filter Media Manager quickly and accurately measures media expansion during backwash. Achieving proper media filter bed expansion during backwash in gravity filters is a crucial step in maintaining filter performance and longevity.

The US EPA recommends 20 to 25% filter bed expansion to adequately clean the filter media (anthracite, sand). Failure to expand the bed sufficiently will result in "mud balls" that degrade the ability of the filter to trap dangerous microorganisms such as Cryptosporidium oocysts and Giardia cysts.

How it works: Lower the sensor to rest on the compacted media bed prior to backwash. Press "Zero" on the controller to set the counter to zero. As the dirt and debris is being evacuated, the red light will illuminate. When the backflow water becomes clear, the media will begin to rise with expansion. Raise the sensor slowly until the red light goes out. Repeat until the bed finishes expanding. The amount of expansion will be noted on the display.

Note: The Filter Media Manager will ship in two containers.

FEATURES & BENEFITS

- Portable - easily take it to where you need to measure media expansion
- Digital controller with backlit display
- Infrared sensor - proven technology provides repeatable precision
- Extendable carbon fiber boom
- Made in the USA

INCLUDES

1-Year Warranty

C&M PART #	MFG PART #	DESCRIPTION
700434	S-60100-R	Round Rail Clamp, 25 ft (7.6 m) Cable
700435	S-60100-S	Square Rail Clamp, 25 ft (7.6 m) Cable



Helpful Tip: Media Filtration

Media Filtration is used to remove solids in drinking water and wastewater treatment plants. The media should be a granular material, such as sand. When the media is cleaned, using a filter media manager prevents backwashing from occurring. Allowing the pump to have a longer life span.

Kupferle Eclipse #88 Series Sampling Stations

Use these above ground Eclipse #88 Series Sampling Stations for 24/7 access to a sampling point directly from the water main. Sampling stations have been allowed for use in the EPA's Revised Total Coliform Rule as a best practice for taking bacteriological samples. They have been shown to lower false positives, speed collection times and reduce liability concerns. Sampling stations are housed in a lockable enclosure and are non-draining to ensure the sample is free of cross-contamination.

The #88 and #88-SS are best used in cold-weather climates while #88WC-SS is best for warmer climates. The cold-weather climate sampling stations are nonfreezing with the use of electric or manual evacuation pumps. Cold-weather sampling stations come standard with a 3' bury depth while warm-weather samplers come with a 1' bury depth. Please call us for additional bury depth options.



FEATURES & BENEFITS

- Lockable, durable, powder-coated cast-aluminum enclosure
- Nondraining to avoid cross contamination
- Waterways and mainline connections in stainless steel or low-lead brass
- Fully serviceable from above ground, no digging required!

CERTIFICATIONS

- Certified NSF/ANSI 61

C&M PART #	MFG PART #	DESCRIPTION
105320	Eclipse #88	Cold-Weather Sampling Station, Low-Lead Brass
105321	Eclipse #88-SS	Cold-Weather Sampling Station, Stainless Steel, Lead Free
105322	Eclipse #88WC-SS	Warm-Weather Sampling Station, Stainless Steel, Lead Free

SHOP OUR FULL SELECTION OF PADLOCKS

View **pages 155-158** of the **Facilities** section to shop our wide selection of padlocks, lockout kits, lock boxes and more. Enhanced security you can rely on when you shop Padlocks with Core & Main.



Signs, Tags & Labels



POTABLE WATER

TABLE OF CONTENTS

Decals & Labels	386-388
Flow Arrow Tapes	388
Marking Tape	388-391
Pipe Markers	392-395
Posts & Hardware	396
Safety Signs	397-409
Safety Tags	410-414

Hard Hat Decals & Labels



108818BASCXY



108811AZSCZP



108812AYSCZP



108813AZSCZP



108814SESCZP



108814SESCZP



108816SESCZP



108817SESCZP

Use these Hard Hat Decals and Labels to inform workers about safety goals, certifications, and to identify first aid trained personnel. Flexible vinyl stickers conform to the curve of a hard hat; can also be easily adhered to machinery, toolboxes and other safety equipment.

C&M PART #	MFG PART #	DESCRIPTION	SIZE	MATERIAL	QUANTITY
108818BASCXY	LHTL366	American Flag Graphic	1"H x 1.75"W	Vinyl	10/Pk
108818BASCYD	LHTL201	American Flag Graphic	1.5"H x 3"W	Vinyl	10/Pk
108811AZSCZP	LHTL114	Confined Space Trained	2.25" Dia	Vinyl	10/Pk
108812AYSCZP	LHTL348	CPR First Aid Certified & Trained	2.25" Dia	Vinyl	10/Pk
108813AZSCZP	LHTL344	Lock-Out Tag-Out Trained	2.25" Dia	Vinyl	10/Pk
108814SESCZP	LHTL354	Safety Committee	2.25" Dia	Vinyl	10/Pk
108815AGSCZP	LHTL304	Safety People/Quality Jobs	2.25" Dia	Vinyl	10/Pk
108816SESCZP	LHTL109	Certified First Aid	2.25" Dia	Vinyl	10/Pk
108817SESCZP	LHTL166	Reuse, Recycle, Reduce	2.25" Dia	Vinyl	10/Pk

Arc Flash Protection Warning Label



108996BISCWX



108998BISCWL



109001BHSCWX



109000BHSCWL



108999BHSCWL



Protect workers by placing these Arc Flash Protection Warning Labels to clearly identify electrical hazards. Each Label indicates the need for proper PPE to ensure worker safety. Labels meet the National Electric Code (NEC) 110.16, National Fire Protection Association (NFPA) 70E-2012, and ANSI Z535.4 for posting warning labels for potentially hazardous arcing faults while working on or near energized electrical equipment.

C&M PART #	MFG PART #	SIZE (H x W)	MATERIAL	QUANTITY
108996BISCWL	LELC313	3.5" x 5"	Dura-Vinyl	5/Pk
108996BISCWX	LELC315	5" x 7"	Dura-Vinyl	5/Pk
108998BISCWL	LELC341	3.5" x 5"	Dura-Vinyl	5/Pk
109001BHSCWX	LELC316	5" x 7"	Dura-Vinyl	5/Pk
109000BHSCWL	LELC308	3.5" x 5"	Dura-Vinyl	5/Pk
109001BHSCWL	LELC309	3.5" x 5"	Dura-Vinyl	5/Pk
108999BHSCWL	LELC318	3.5" x 5"	Dura-Vinyl	5/Pk

Confined Space Safety Labels

Place these OSHA Safety Labels to clearly indicate the proper procedure requirements before confined space entry.



108611BISCWL



108612BISCWL



108613BISCWL



108614BISCWL

C&M PART #	MFG PART #	SIZE (H x W)	MATERIAL	QUANTITY
108611BISCWL	LCSP280VSP	3.5" x 5"	Vinyl	5/Pk
108612BISCWL	LCSP240VSP	3.5" x 5"	Vinyl	5/Pk
108613BISCWL	LCSP242VSP	3.5" x 5"	Vinyl	5/Pk
108614BISCWL	LCSP274VSP	3.5" x 5"	Vinyl	5/Pk



Electrical Hazard Labels



Place these warning labels to alert employees and guests of potential electrical hazards in the immediate vicinity.

C&M PART #	MFG PART #	SIZE (H x W)	MATERIAL	QUANTITY
108987BISCWL	LELC001VSP	3.5" x 5"	Vinyl	5/Pk
108988BISCWL	LELC795VSP	3.5" x 5"	Vinyl	5/Pk
108989BISCWL	LELC248VSP	3.5" x 5v	Vinyl	5/Pk
108990BISCWL	LELC150VSP	3.5" x 5"	Vinyl	5/Pk
108991BISCWL	LELC153VSP	3.5" x 5"	Vinyl	5/Pk
108992BISCWL	LELC154VSP	3.5" x 5"	Vinyl	5/Pk
108993BISCWL	LELC156VSP	3.5" x 5"	Vinyl	5/Pk
108994BISCWL	LELC164VSP	3.5" x 5"	Vinyl	5/Pk
108995AMSCIA	LELC525VSP	3.5" x 5"	Vinyl	5/Pk

Fire Extinguisher Labels



Apply labels to indicate the location of a fire extinguisher and to ensure extinguisher inspection status and record.

C&M PART #	MFG PART #	SIZE (H x W)	MATERIAL	QUANTITY
108783SFSCWL	LFXG440VSP	3.5" x 5"	Vinyl	5/Pk
108784AYSCWL	LVHR565VSP	3.5" x 5"	Vinyl	5/Pk
108785AYSCWV	LFXG528VSP	3.5" x 5"	Vinyl	5/Pk

Emergency Shower & Eyewash Safety Label

Emergency heading gets attention and warns associates not to obstruct designated first aid areas. The label promotes safe practices with a pictogram that indicates purpose of station to non-English speakers.



C&M PART #	MFG PART #	SIZE (H x W)	MATERIAL	QUANTITY
108870AOSCW	LFSD904VSP	3.5" x 5"	Vinyl	5/Pk

Housekeeping & Hygiene Safety Labels



Watch your step: Place these labels to warn of a trip hazard. Various sizes and colors help ensure they are visible.

No smoking: Use these labels to inform workers and guests that the area is a designated no smoking area. All signs clearly state message through graphics.

C&M PART #	MFG PART #	SIZE (H x W)	MATERIAL	QUANTITY
108658BJSCZG	LSTF511VSP	2" x 12"	Vinyl	5/Pk
108659BJSCWL	LSTF601VSP	3.5" x 5"	Vinyl	5/Pk
108660BJSCZO	LSTF610VSP	2" x 6"	Vinyl	5/Pk
108661AMSCZO	LSTF520VSP	2" x 6"	Vinyl	5/Pk
108662BISC3F	LSMK510VSP	4" x 4"	Vinyl	5/Pk
108663BISCYL	LSMK504VSP	1.5" x 3"	Vinyl	10/Pk
108664BISCYL	LSMK503VSP	1.5" x 3"	Vinyl	10/Pk

Hard Hat Retro-Reflective Stickers

Easily identify workers in a wide range of light conditions with these highly reflective helmet stickers.



C&M PART #	MFG PART #	COLOR	SIZE (H x W)	MATERIAL
108574D5SCXW	LHR104WT	White	1" x 4"	Vinyl
108574B7SCXW	LHR104RDOR	Red-Orange	1" x 4"	Vinyl
108574I9SCXW	LHR104BU	Blue	1" x 4"	Vinyl
108574A7SCXW	LHR104RD	Red	1" x 4"	Vinyl
108574AASCXW	LHR104GNYL	Green-Yellow	1" x 4"	Vinyl



Lockout Tagout Safety Labels



109054BISCWL



109055BISCWL



109056BISCWL



109057BJSCWL



109060BIC7IE

Caution all readers to lockout devices to ensure safety of personnel.



C&M PART #	MFG PART #	SIZE (H x W)	MATERIAL	QUANTITY
109054BISCWL	LLKT295VSP	3.5" x 5"	Vinyl	5/Pk
109055BISCWL	LLKT286VSP	3.5" x 5"	Vinyl	5/Pk
109056BISCWL	LLKT530VSP	3.5" x 5"	Vinyl	5/Pk
109057BJSCWL	LLKT611VSP	3.5" x 5"	Vinyl	5/Pk
109060BIC7IE	LLKT109	7" x 5"	Vinyl	Each
109060BIC7WV	LLKT111	5" x 3.5"	Vinyl	Each

Color-Coded Directional Flow Arrow Tapes

Mark directional flow of pipe contents throughout your facility with these Color-Coded Arrow Tapes. Repeated arrows on the entire length of the tape provide 360-degree visibility for flow direction. Self-adhesive vinyl with acrylic adhesive sticks easily on pipes. Tapes are available 1", 2", and 4" widths and are 54-ft long.

Compliance: ANSI / ASME A13.1 standard for pipe markings including the 3.3 mil white polypropylene with 1.0 mil clear polypropylene over lamination ANSI / ASME A13.1-2007 standard.



C&M PART #	MFG PART #	SIZE (W X L)
BLACK/ORANGE VINYL ROLLS		
108936HGSCYB	RAW252BKOR	1" x 54 ft
108936HGSCOM	RAW254BKOR	2" x 54 ft
108936HGSCWT	RAW258BKOR	4" x 54 ft
BLACK/YELLOW VINYL ROLLS		
108936F8SCYB	RAW252BKYL	1" x 54 ft
108936F8SCOM	RAW254BKYL	2" x 54 ft
108936F8SCWT	RAW258BKYL	4" x 54 ft
GREEN/WHITE VINYL ROLLS		
108936SESCYB	RAW252GNWT	1" x 54 ft
108936SESCOM	RAW254GNWT	2" x 54 ft
BLUE/WHITE VINYL ROLLS		
108936SCSCYB	RAW252BUWT	1" x 54 ft
108936SCSCOM	RAW254BUWT	2" x 54 ft
108936SCSCWT	RAW258BUWT	4" x 54 ft
RED/WHITE VINYL ROLLS		
108936SFSCOM	RAW254RDWT	2" x 54 ft
108936SFSCWT	RAW258RDWT	4" x 54 ft

Walk-On Slip-Gard™ Floor Marking Kits



The Walk-On Floor Marking Kit includes eight pre-cut border pieces and one 12" x 12" diamond shape floor sign to help keep areas in front of fire extinguishers, eye wash/shower stations and other equipment free and clear of obstruction. Configure them in four different ways to fit your area. They are textured overlaminated to provide a nonslip surface.



C&M PART #	MFG PART #	DESCRIPTION	COLOR
109198ALSCWM	WFK01	Emergency Eyewash Keep Clear	Green
109199ALSCWM	WFK02	Emergency Shower Keep Clear	Green
109200BJSCWM	WFK05	Electrical Panel Keep Clear	Yellow
109201BJSCWM	WFK06	Do Not Block	Yellow
109202AYSCWM	WFK07	Fire Extinguisher Keep Clear	Red
109203AYSCWM	WFK08	Fire Exit Keep Clear	Red
109204AYSCWM	WFK10	Red Tag Holding Area	Red
109205AGSCWM	WFK11	Cleaning Station Keep Clear	Blue

Floor Marking Tapes

C&M PART #	MFG PART #	COLOR	SIZE (W x L)	MATERIAL	QUANTITY
TOUGH-MARK HEAVY-DUTY FLOOR MARKING STRIPS					
109062D7SGZK	PTP202YL	Yellow	2" x 48"	PE/PP	10/Pk
109062D7SGWD	PTP203YL	Yellow	3" x 48"	PE/PP	10/Pk
109062D7SG1M	PTP204YL	Yellow	4" x 48"	PE/PP	10/Pk
10906268SGZK	PTP202GN	Green	2" x 48"	PE/PP	10/Pk
10906268SGWD	PTP203GN	Green	3" x 48"	PE/PP	10/Pk
10906268SG1M	PTP204GN	Green	4" x 48"	PE/PP	10/Pk
109062A7SGZK	PTP202RD	Red	2" x 48"	PE/PP	10/Pk
109062A7SGWD	PTP203RD	Red	3" x 48"	PE/PP	10/Pk
109062A7SG1M	PTP204RD	Red	4" x 48"	PE/PP	10/Pk
30-MIL DURABLE FLOOR TAPES					
109092D7C7ZF	DT2Y	Yellow	2" x 100 ft	Vinyl	Roll
109092D7C7WP	DT4Y	Yellow	4" x 100 ft	Vinyl	Roll
10909268C7ZF	DT2G	Green	2" x 100 ft	Vinyl	Roll
10909268C7WP	DT4G	Green	4" x 100 ft	Vinyl	Roll
109092A7C7ZF	DT2R	Red	2" x 100 ft	Vinyl	Roll
109092A7C7WP	DT4R	Red	4" x 100 ft	Vinyl	Roll
10909219C7ZF	DT2B	Blue	2" x 100 ft	Vinyl	Roll
10909219C7WP	DT4B	Blue	4" x 100 ft	Vinyl	Roll
50-MIL HEAVY-DUTY FLOOR TAPES					
109071D7A4ZF	HDT2Y	Yellow	2" x 100 ft	PVC	Roll
109071D7A4ZW	HDT3Y	Yellow	3" x 100 ft	PVC	Roll
109071D7A4WP	HDT4Y	Yellow	4" x 100 ft	PVC	Roll
10907168A4ZF	HDT2G	Green	2" x 100 ft	PVC	Roll
10907168A4ZW	HDT3G	Green	3" x 100 ft	PVC	Roll
10907168A4WP	HDT4G	Green	4" x 100 ft	PVC	Roll
109071A7A4ZF	HDT2R	Red	2" x 100 ft	PVC	Roll
109071A7A4ZW	HDT3R	Red	3" x 100 ft	PVC	Roll
109071A7A4WP	HDT4R	Red	4" x 100 ft	PVC	Roll
10907119A4ZF	HDT2B	Blue	2" x 100 ft	PVC	Roll
10907119A4ZW	HDT3B	Blue	3" x 100 ft	PVC	Roll
10907119A4WP	HDT4B	Blue	4" x 100 ft	PVC	Roll
10907117A4ZF	HDT2BK	Black	2" x 100 ft	PVC	Roll
10907117A4ZW	HDT3BK	Black	3" x 100 ft	PVC	Roll
10907117A4WP	HDT4BK	Black	4" x 100 ft	PVC	Roll
10907193A4ZF	HDT2OR	Orange	2" x 100 ft	PVC	Roll
10907193A4ZW	HDT3OR	Orange	3" x 100 ft	PVC	Roll
10907193A4WP	HDT4OR	Orange	4" x 100 ft	PVC	Roll
109071F8A4ZF	HDT2BKYL	Black/Yellow	2" x 100 ft	PVC	Roll
109071F8A4ZW	HDT3BKYL	Black/Yellow	3" x 100 ft	PVC	Roll
109071F8A4WP	HDT4BKYL	Black/Yellow	4" x 100 ft	PVC	Roll
GLOW-IN-THE-DARK FLOOR TAPE					
109152D7SJIN	PTM911	Solid	2" x 15 ft	Polyester	Roll
109152D7SJWA	PTM915	Solid	3" x 15 ft	Polyester	Roll
109152BJSJIN	PTM922	Stripe	2" x 15 ft	Polyester	Roll
109152BJSJWA	PTM926	Stripe	3" x 15 ft	Polyester	Roll

Tough-Mark Heavy-Duty Floor Marking Strips



30-Mil Durable Floor Tapes



50-Mil Heavy-Duty Floor Tapes



Glow-in-the-Dark Floor Tape



ACCUFORM
Justice Safety Group



The **Tough -Mark™ Marking Strips** are heavy-duty composite tape that outperforms standard floor marking tapes. Strips are made of 55-mil thick polyethylene with 9.4-mil thick polypropylene backing. A high-gloss surface resists marks, smudges, abrasions, water, chemicals and heat. Easily trim to needed length or to create corners.

The **30-Mil Thick Durable Tapes** come in a variety of colors with rubber-based, pressure -sensitive adhesive. Fade-resistant colors are ideal for long-term floor marking. Made from highly durable material, tapes withstand tough environments.

The **50-Mil Heavy-Duty Tapes** are designed for long-term floor marking, yet still removes cleanly. Tapes are smooth, easy to clean and slip resistant. Dual beveled edges allow industrial wheels to roll over smoothly and withstand forklift traffic, industrial brush scrubbers, and other equipment.

The **Glow-In-The-Dark Tapes** allow visibility and safety in low-light and emergency blackout situations. Tapes are "energized" by any light source and glow in yellow-green color; longer the exposure to light, the longer glow time.

Safety Marking Tape



Solid Reflective Safety Marking Tapes



Ensure safety of visitors and employees by marking possible hazards with these Safety Marking Tapes. These 6-mil thick vinyl tapes apply easily to clean, smooth, dry surfaces with a synthetic rubber resin adhesive.

Place reflective marking tapes on posts, poles, barricades and fences. They provide high visibility during the day and “bounce back” reflectivity at night. Hazard safety marking tapes are waterproof and wear resistant and can be used from -20 to 175°F. They are ideal for aisle marking, pipe wrapping, color coding and general safety marking.

C&M PART #	MFG PART #	COLOR	SIZE (W x L)	QUANTITY
SOLID HAZARD SAFETY MARKING TAPES				
10915617SCZJ	T214	Black	2" x 36 yd	Roll
10915617SCWC	T244	Black	3" x 36 yd	Roll
109156D5SCZJ	T206	White	2" x 36 yd	Roll
109156D5SCWC	T236	White	3" x 36 yd	Roll
10915693SCZJ	T209	Orange	2" x 36 yd	Roll
10915693SCWC	T239	Orange	3" x 36 yd	Roll
10915619SCZJ	T210	Blue	2" x 36 yd	Roll
10915619SCWC	T240	Blue	3" x 36 yd	Roll
10915668SCZJ	T208	Green	2" x 36 yd	Roll
10915668SCWC	T238	Green	3" x 36 yd	Roll
109156D7SCZJ	T205	Yellow	2" x 36 yd	Roll
109156D7SCWC	T235	Yellow	3" x 36 yd	Roll
109156A7SCZJ	T204	Red	2" x 36 yd	Roll
109156A7SCWC	T234	Red	3" x 36 yd	Roll
10915631SCZJ	T212	Brown	2" x 36 yd	Roll
10915631SCWC	T242	Brown	3" x 36 yd	Roll

Solid Hazard Safety Marking Tapes



C&M PART #	MFG PART #	COLOR	SIZE (W x L)	QUANTITY
SOLID REFLECTIVE SAFETY MARKING TAPES				
109100D5SCXZ	RPS1W	White	1" x 10 yd	Roll
109100D5SCZE	RPS2W	White	2" x 10 yd	Roll
109100D5SCZZ	RPS3W	White	3" x 10 yd	Roll
109100D5SCWO	RPS4W	White	4" x 10 yd	Roll
109100D5SCYA	RPS5W	White	1" x 50 yd	Roll
109100D5SCZM	RPS6W	White	2" x 50 yd	Roll
109100D5SCWE	RPS7W	White	3" x 50 yd	Roll
109100D5SCWS	RPS8W	White	4" x 50 yd	Roll
10910093SCXZ	RPS1O	Orange	1" x 10 yd	Roll
10910093SCZE	RPS2O	Orange	2" x 10 yd	Roll
10910093SCZZ	RPS3O	Orange	3" x 10 yd	Roll
10910093SCWO	RPS4O	Orange	4" x 10 yd	Roll
10910093SCYA	RPS5O	Orange	1" x 50 yd	Roll
10910093SCZM	RPS6O	Orange	2" x 50 yd	Roll
10910093SCWE	RPS7O	Orange	3" x 50 yd	Roll
10910093SCWS	RPS8O	Orange	4" x 50 yd	Roll
10910019SCXZ	RPS1B	Blue	1" x 10 yd	Roll
10910019SCZE	RPS2B	Blue	2" x 10 yd	Roll
10910019SCZZ	RPS3B	Blue	3" x 10 yd	Roll
10910019SCWO	RPS4B	Blue	4" x 10 yd	Roll
10910019SCYA	RPS5B	Blue	1" x 50 yd	Roll
10910019SCZM	RPS6B	Blue	2" x 50 yd	Roll
10910019SCWE	RPS7B	Blue	3" x 50 yd	Roll
10910019SCWS	RPS8B	Blue	4" x 50 yd	Roll
10910068SCXZ	RPS1G	Green	1" x 10 yd	Roll
10910068SCZE	RPS2G	Green	2" x 10 yd	Roll
10910068SCZZ	RPS3G	Green	3" x 10 yd	Roll
10910068SCWO	RPS4G	Green	4" x 10 yd	Roll
10910068SCYA	RPS5G	Green	1" x 50 yd	Roll
10910068SCZM	RPS6G	Green	2" x 50 yd	Roll
10910068SCWE	RPS7G	Green	3" x 50 yd	Roll
10910068SCWS	RPS8G	Green	4" x 50 yd	Roll
109100D7SCXZ	RPS1Y	Yellow	1" x 10 yd	Roll
109100D7SCZE	RPS2Y	Yellow	2" x 10 yd	Roll
109100D7SCZZ	RPS3Y	Yellow	3" x 10 yd	Roll
109100D7SCWO	RPS4Y	Yellow	4" x 10 yd	Roll
109100D7SCYA	RPS5Y	Yellow	1" x 50 yd	Roll
109100D7SCZM	RPS6Y	Yellow	2" x 50 yd	Roll
109100D7SCWE	RPS7Y	Yellow	3" x 50 yd	Roll
109100D7SCWS	RPS8Y	Yellow	4" x 50 yd	Roll
109100A7SCXZ	RPS1R	Red	1" x 10 yd	Roll
109100A7SCZE	RPS2R	Red	2" x 10 yd	Roll
109100A7SCZZ	RPS3R	Red	3" x 10 yd	Roll
109100A7SCWO	RPS4R	Red	4" x 10 yd	Roll
109100A7SCYA	RPS5R	Red	1" x 50 yd	Roll
109100A7SCZM	RPS6R	Red	2" x 50 yd	Roll
109100A7SCWE	RPS7R	Red	3" x 50 yd	Roll
109100A7SCWS	RPS8R	Red	4" x 50 yd	Roll

Continued on Next Page



Safety Marking Tape *(continued)*

C&M PART #	MFG PART #	COLOR	SIZE (W x L)	QUANTITY
STRIPED HAZARD SAFETY MARKING TAPES				
109172F8SCZI	T20218	Black/Yellow	2" x 18 yd	Roll
109172F8SCZJ	T20236	Black/Yellow	2" x 36 yd	Roll
109172F8SCWB	T22018	Black/Yellow	3" x 18 yd	Roll
109172F8SCWC	T22036	Black/Yellow	3" x 36 yd	Roll
109172ARSCZI	T20718	Magenta/Yellow	2" x 18 yd	Roll
109172ARSCZJ	T20736	Magenta/Yellow	2" x 36 yd	Roll
109172AESCZI	T20118	Black/White	2" x 18 yd	Roll
109172AESCZJ	T20136	Black/White	2" x 36 yd	Roll
109172AESCWB	T22118	Black/White	3" x 18 yd	Roll
109172AESCWC	T22136	Black/White	3" x 36 yd	Roll
109172AYSCZI	T20318	Red/White	2" x 18 yd	Roll
109172AYSCZJ	T20336	Red/White	2" x 36 yd	Roll
109172AYSCWB	T22318	Red/White	3" x 18 yd	Roll
109172AYSCWC	T22336	Red/White	3" x 36 yd	Roll
109172AGSCZI	T20418	Blue/White	2" x 18 yd	Roll
109172AGSCZJ	T20436	Blue/White	2" x 36 yd	Roll
109172AGSCWB	T22418	Blue/White	3" x 18 yd	Roll
109172AGSCWC	T22436	Blue/White	3" x 36 yd	Roll
109172ATSCZI	T20918	Orange/White	2" x 18 yd	Roll
109172ATSCZJ	T20936	Orange/White	2" x 36 yd	Roll
109172ATSCWB	T22918	Orange/White	3" x 18 yd	Roll
109172ATSCWC	T22936	Orange/White	3" x 36 yd	Roll
109172ATSCZI	T20818	Green/White	2" x 18 yd	Roll
109172ATSCZJ	T20836	Green/White	2" x 36 yd	Roll
109172ATSCWB	T22818	Green/White	3" x 18 yd	Roll
109172ATSCWC	T22836	Green/White	3" x 36 yd	Roll

C&M PART #	MFG PART #	COLOR	SIZE (W x L)	QUANTITY
STRIPED REFLECTIVE SAFETY MARKING TAPES				
109148AYSCZE	RHS2RS	Red/White	2" x 10 yd	Roll
109148AYSCZZ	RHS3RS	Red/White	3" x 10 yd	Roll
109148BJSCZE	RHS2BY	Black/Yellow	2" x 10 yd	Roll
109148BJSCZZ	RHS3BY	Black/Yellow	3" x 10 yd	Roll

Striped Reflective Safety Marking Tapes



Striped Hazard Safety Marking Tapes



Helpful Tip: Sign Muscle

Accuform NMC is a reputable company that specializes in producing high-quality safety signs and labels. The "Sign Muscle" product line is a collaboration offering a range of durable and heavy-duty signs designed to withstand challenging environments.

Accuform NMC Sign Muscle signs are known for their exceptional durability and visibility, making them ideal for industrial settings, construction sites, and other workplaces where safety is a top priority. These signs are constructed with robust materials that can withstand harsh conditions, such as extreme temperatures, moisture, chemicals, and UV exposure. This ensures that the signs remain highly visible and legible, even in demanding environments.



Performance Tested

Products coated with Sign Muscle® are graffiti resistant to eliminate vandalism, scratches, and much more.



PREVENTS
FADING AND
YELLOWING



TAGGER
RESISTANT



CHEMICAL
RESISTANT



ABRASION
RESISTANT



CRACK
RESISTANT



NO
ADDITIONAL
COST



Pipe Markers

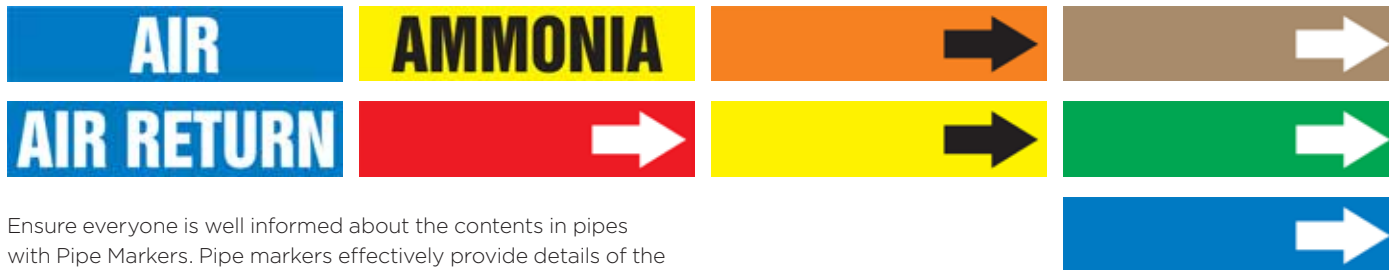

Ensure everyone is well informed about the contents in pipes with Pipe Markers. Pipe markers effectively provide details of the flow direction and hazard classification preventing incidents and ensuring safety.

Pipes containing Ammonia refrigeration need to meet the International Institute of Ammonia Refrigeration (IIR) universal guidelines. GHS pipe marking is the uniform, worldwide system for the labeling of pipes that hold or transport chemical substances.

C&M PART #	MFG PART #	COLOR	PIPE SIZE	STYLE
AIR				
107520HG	RPK123SSA	White/Blue	3/4 to 1-1/4"	Self-Stick
107520SA	RPK123SSB	White/Blue	1-1/2 to 2"	Self-Stick
107520SB	RPK123SSD	White/Blue	2-1/2 to 6"	Self-Stick
107520SC	RPK123SSH	White/Blue	8 to 10"	Self-Stick
107524HG	RPK123STA	White/Blue	3/4 to 1-1/4"	Snap-Tite
107524SA	RPK123STB	White/Blue	1-1/2 to 2"	Snap-Tite
107524SE	RPK123STC	White/Blue	2-1/4 to 3"	Snap-Tite
AIR RETURN				
107529HG	RPK125SSA	White/Blue	3/4 to 1-1/4"	Snap-Tite
107529SA	RPK125SSB	White/Blue	1-1/2 to 2"	Snap-Tite
107529SB	RPK125SSD	White/Blue	2-1/2 to 6"	Snap-Tite
107529SC	RPK125SSH	White/Blue	8 to 10"	Snap-Tite
107533HG	RPK125STA	White/Blue	3/4 to 1-1/4"	Snap-Tite
107533SA	RPK125STB	White/Blue	1-1/2 to 2"	Snap-Tite
107533SE	RPK125STC	White/Blue	2-1/4 to 3"	Snap-Tite
AMMONIA				
107542HG	RPK137SSA	Black/Yellow	3/4 to 1-1/4"	Self-Stick
107542SA	RPK137SSB	Black/Yellow	1-1/2 to 2"	Self-Stick
107542SB	RPK137SSD	Black/Yellow	2-1/2 to 6"	Self-Stick
107542SC	RPK137SSH	Black/Yellow	8 to 10"	Self-Stick
107546HG	RPK137STA	Black/Yellow	3/4 to 1-1/4"	Snap-Tite
107546SA	RPK137STB	Black/Yellow	1-1/2 to 2"	Snap-Tite
107546SE	RPK137STC	Black/Yellow	2-1/4 to 3"	Snap-Tite
ARROW				
107886HG	RPK759SSA	White/Red	3/4 to 1-1/4"	Self-Stick
107886SA	RPK759SSB	White/Red	1-1/2 to 2"	Self-Stick
107886SB	RPK759SSD	White/Red	2-1/2 to 6"	Self-Stick
107886SC	RPK759SSH	White/Red	8 to 10"	Self-Stick
107890HG	RPK759STA	White/Red	3/4 to 1-1/4"	Snap-Tite
107890SA	RPK759STB	White/Red	1-1/2 to 2"	Snap-Tite
107890SE	RPK759STC	White/Red	2-1/4 to 3"	Snap-Tite

C&M PART #	MFG PART #	COLOR	PIPE SIZE	STYLE
ARROW (CONTINUED)				
107895HG	RPK761SSA	Black/Orange	3/4 to 1-1/4"	Self-Stick
107895SA	RPK761SSB	Black/Orange	1-1/2 to 2"	Self-Stick
107895SB	RPK761SSD	Black/Orange	2-1/2 to 6"	Self-Stick
107895SC	RPK761SSH	Black/Orange	8 to 10"	Self-Stick
107899HG	RPK761STA	Black/Orange	3/4 to 1-1/4"	Snap-Tite
107899SA	RPK761STB	Black/Orange	1-1/2 to 2"	Snap-Tite
107899SE	RPK761STC	Black/Orange	2-1/4 to 3"	Snap-Tite
107904HG	RPK763SSA	Black/Yellow	3/4 to 1-1/4"	Self-Stick
107904SA	RPK763SSB	Black/Yellow	1-1/2 to 2"	Self-Stick
107904SB	RPK763SSD	Black/Yellow	2-1/2 to 6"	Self-Stick
107904SC	RPK763SSH	Black/Yellow	8 to 10"	Self-Stick
107908HG	RPK763STA	Black/Yellow	3/4 to 1-1/4"	Snap-Tite
107908SA	RPK763STB	Black/Yellow	1-1/2 to 2"	Snap-Tite
107908SE	RPK763STC	Black/Yellow	2-1/4 to 3"	Snap-Tite
107913HG	RPK765SSA	White/Brown	3/4 to 1-1/4"	Self-Stick
107913SA	RPK765SSB	White/Brown	1-1/2 to 2"	Self-Stick
107913SB	RPK765SSD	White/Brown	2-1/2 to 6"	Self-Stick
107913SC	RPK765SSH	White/Brown	8 to 10"	Self-Stick
107917HG	RPK765STA	White/Brown	3/4 to 1-1/4"	Snap-Tite
107917SA	RPK765STB	White/Brown	1-1/2 to 2"	Snap-Tite
107917SE	RPK765STC	White/Brown	2-1/4 to 3"	Snap-Tite
107922HG	RPK767SSA	White/Green	3/4 to 1-1/4"	Self-Stick
107922SA	RPK767SSB	White/Green	1-1/2 to 2"	Self-Stick
107922SB	RPK767SSD	White/Green	2-1/2 to 6"	Self-Stick
107922SC	RPK767SSH	White/Green	8 to 10"	Self-Stick
107926HG	RPK767STA	White/Green	3/4 to 1-1/4"	Snap-Tite
107926SA	RPK767STB	White/Green	1-1/2 to 2"	Snap-Tite
107926SE	RPK767STC	White/Green	2-1/4 to 3"	Snap-Tite
107931HG	RPK769SSA	White/Blue	3/4 to 1-1/4"	Self-Stick
107931SA	RPK769SSB	White/Blue	1-1/2 to 2"	Self-Stick
107931SB	RPK769SSD	White/Blue	2-1/2 to 6"	Self-Stick
107931SC	RPK769SSH	White/Blue	8 to 10"	Self-Stick
107935HG	RPK769STA	White/Blue	3/4 to 1-1/4"	Snap-Tite
107935SA	RPK769STB	White/Blue	1-1/2 to 2"	Snap-Tite
107935SE	RPK769STC	White/Blue	2-1/4 to 3"	Snap-Tite

Continued on Next Page



Pipe Markers (continued)



C&M PART #	MFG PART #	COLOR	PIPE SIZE	STYLE
CAUSTIC				
107559HG	RPK185SSA	Black/Yellow	3/4 to 1-1/4"	Self-Stick
107559SA	RPK185SSB	Black/Yellow	1-1/2 to 2"	Self-Stick
107559SB	RPK185SSD	Black/Yellow	2-1/2 to 6"	Self-Stick
107559SC	RPK185SSH	Black/Yellow	8 to 10"	Self-Stick
107563HG	RPK185STA	Black/Yellow	3/4 to 1-1/4"	Snap-Tite
107563SA	RPK185STB	Black/Yellow	1-1/2 to 2"	Snap-Tite
107563SE	RPK185STC	Black/Yellow	2-1/4 to 3"	Snap-Tite
CHILLED WATER RETURN				
107576HG	RPK201SSA	White/Green	3/4 to 1-1/4"	Self-Stick
107576SA	RPK201SSB	White/Green	1-1/2 to 2"	Self-Stick
107576SB	RPK201SSD	White/Green	2-1/2 to 6"	Self-Stick
107576SC	RPK201SSH	White/Green	8 to 10"	Self-Stick
107580HG	RPK201STA	White/Green	3/4 to 1-1/4"	Snap-Tite
107580SA	RPK201STB	White/Green	1-1/2 to 2"	Snap-Tite
107580SE	RPK201STC	White/Green	2-1/4 to 3"	Snap-Tite
CHILLED WATER SUPPLY				
107585HG	RPK203SSA	White/Green	3/4 to 1-1/4"	Self-Stick
107585SA	RPK203SSB	White/Green	1-1/2 to 2"	Self-Stick
107585SB	RPK203SSD	White/Green	2-1/2 to 6"	Self-Stick
107585SC	RPK203SSH	White/Green	8 to 10"	Self-Stick
107589HG	RPK203STA	White/Green	3/4 to 1-1/4"	Snap-Tite
107589SA	RPK203STB	White/Green	1-1/2 to 2"	Snap-Tite
107589SE	RPK203STC	White/Green	2-1/4 to 3"	Snap-Tite
CHLORINE				
107598HG	RPK207SSA	Black/Yellow	3/4 to 1-1/4"	Self-Stick
107598SA	RPK207SSB	Black/Yellow	1-1/2 to 2"	Self-Stick
107598SB	RPK207SSD	Black/Yellow	2-1/2 to 6"	Self-Stick
107598SC	RPK207SSH	Black/Yellow	8 to 10"	Self-Stick
107602HG	RPK207STA	Black/Yellow	3/4 to 1-1/4"	Snap-Tite
107602SA	RPK207STB	Black/Yellow	1-1/2 to 2"	Snap-Tite
107602SE	RPK207STC	Black/Yellow	2-1/4 to 3"	Snap-Tite
COLD WATER				
107611HG	RPK217SSA	White/Green	3/4 to 1-1/4"	Self-Stick
107611SA	RPK217SSB	White/Green	1-1/2 to 2"	Self-Stick
107611SB	RPK217SSD	White/Green	2-1/2 to 6"	Self-Stick
107611SC	RPK217SSH	White/Green	8 to 10"	Self-Stick
107615HG	RPK217STA	White/Green	3/4 to 1-1/4"	Snap-Tite
107615SA	RPK217STB	White/Green	1-1/2 to 2"	Snap-Tite
107615SE	RPK217STC	White/Green	2-1/4 to 3"	Snap-Tite

C&M PART #	MFG PART #	COLOR	PIPE SIZE	STYLE
COLD WATER SUPPLY				
107620HG	RPK223SSA	White/Green	3/4 to 1-1/4"	Self-Stick
107620SA	RPK223SSB	White/Green	1-1/2 to 2"	Self-Stick
107620SB	RPK223SSD	White/Green	2-1/2 to 6"	Self-Stick
107620SC	RPK223SSH	White/Green	8 to 10"	Self-Stick
107624HG	RPK223STA	White/Green	3/4 to 1-1/4"	Snap-Tite
107624SA	RPK223STB	White/Green	1-1/2 to 2"	Snap-Tite
107624SE	RPK223STC	White/Green	2-1/4 to 3"	Snap-Tite
COMPRESSED AIR				
107629HG	RPK225SSA	Black/Yellow	3/4 to 1-1/4"	Self-Stick
107629SA	RPK225SSB	Black/Yellow	1-1/2 to 2"	Self-Stick
107629SB	RPK225SSD	Black/Yellow	2-1/2 to 6"	Self-Stick
107629SC	RPK225SSH	Black/Yellow	8 to 10"	Self-Stick
107633HG	RPK225STA	Black/Yellow	3/4 to 1-1/4"	Snap-Tite
107633SA	RPK225STB	Black/Yellow	1-1/2 to 2"	Snap-Tite
107633SE	RPK225STC	Black/Yellow	2-1/4 to 3"	Snap-Tite
107633SF	RPK225STE	Black/Yellow	3-1/4 to 5"	Snap-Tite
107633SG	RPK225STF	Black/Yellow	5-1/4 to 6"	Snap-Tite
107638HG	RPK227SSA	White/Blue	3/4 to 1-1/4"	Self-Stick
107638SA	RPK227SSB	White/Blue	1-1/2 to 2"	Self-Stick
107638SB	RPK227SSD	White/Blue	2-1/2 to 6"	Self-Stick
107638SC	RPK227SSH	White/Blue	8 to 10"	Self-Stick
107642HG	RPK227STA	White/Blue	3/4 to 1-1/4"	Snap-Tite
107642SA	RPK227STB	White/Blue	1-1/2 to 2"	Snap-Tite
107642SE	RPK227STC	White/Blue	2-1/4 to 3"	Snap-Tite
CONDENSATE				
107647HG	RPK229SSA	Black/Yellow	3/4 to 1-1/4"	Self-Stick
107647SA	RPK229SSB	Black/Yellow	1-1/2 to 2"	Self-Stick
107647SB	RPK229SSD	Black/Yellow	2-1/2 to 6"	Self-Stick
107647SC	RPK229SSH	Black/Yellow	8 to 10"	Self-Stick
107651HG	RPK229STA	Black/Yellow	3/4 to 1-1/4"	Snap-Tite
107651SA	RPK229STB	Black/Yellow	1-1/2 to 2"	Snap-Tite
107651SE	RPK229STC	Black/Yellow	2-1/4 to 3"	Snap-Tite
COOLING WATER				
107656HG	RPK247SSA	White/Green	3/4 to 1-1/4"	Self-Stick
107656SA	RPK247SSB	White/Green	1-1/2 to 2"	Self-Stick
107656SB	RPK247SSD	White/Green	2-1/2 to 6"	Self-Stick
107656SC	RPK247SSH	White/Green	8 to 10"	Self-Stick
107660HG	RPK247STA	White/Green	3/4 to 1-1/4"	Snap-Tite
107660SA	RPK247STB	White/Green	1-1/2 to 2"	Snap-Tite
107660SE	RPK247STC	White/Green	2-1/4 to 3"	Snap-Tite

Continued on Next Page



Pipe Markers *(continued)*



C&M PART #	MFG PART #	COLOR	PIPE SIZE	STYLE
COOLING WATER RETURN				
107665HG	RPK249SSA	White/Green	3/4 to 1-1/4"	Self-Stick
107665SA	RPK249SSB	White/Green	1-1/2 to 2"	Self-Stick
107665SB	RPK249SSD	White/Green	2-1/2 to 6"	Self-Stick
107665SC	RPK249SSH	White/Green	8 to 10"	Self-Stick
107669HG	RPK249STA	White/Green	3/4 to 1-1/4"	Snap-Tite
107669SA	RPK249STB	White/Green	1-1/2 to 2"	Snap-Tite
107669SE	RPK249STC	White/Green	2-1/4 to 3"	Snap-Tite
DEIONIZED WATER				
107674HG	RPK253SSA	White/Green	3/4 to 1-1/4"	Self-Stick
107674SA	RPK253SSB	White/Green	1-1/2 to 2"	Self-Stick
107674SB	RPK253SSD	White/Green	2-1/2 to 6"	Self-Stick
107674SC	RPK253SSH	White/Green	8 to 10"	Self-Stick
107678HG	RPK253STA	White/Green	3/4 to 1-1/4"	Snap-Tite
107678SA	RPK253STB	White/Green	1-1/2 to 2"	Snap-Tite
107678SE	RPK253STC	White/Green	2-1/4 to 3"	Snap-Tite
DEIONIZED WATER SUPPLY				
107683HG	RPK257SSA	White/Green	3/4 to 1-1/4"	Self-Stick
107683SA	RPK257SSB	White/Green	1-1/2 to 2"	Self-Stick
107683SB	RPK257SSD	White/Green	2-1/2 to 6"	Self-Stick
107683SC	RPK257SSH	White/Green	8 to 10"	Self-Stick
107687HG	RPK257STA	White/Green	3/4 to 1-1/4"	Snap-Tite
107687SA	RPK257STB	White/Green	1-1/2 to 2"	Snap-Tite
107687SE	RPK257STC	White/Green	2-1/4 to 3"	Snap-Tite
FIRE MAIN				
107716HG	RPK321SSA	White/Red	3/4 to 1-1/4"	Self-Stick
107716SA	RPK321SSB	White/Red	1-1/2 to 2"	Self-Stick
107716SB	RPK321SSD	White/Red	2-1/2 to 6"	Self-Stick
107716SC	RPK321SSH	White/Red	8 to 10"	Self-Stick
107720HG	RPK321STA	White/Red	3/4 to 1-1/4"	Snap-Tite
107720SA	RPK321STB	White/Red	1-1/2 to 2"	Snap-Tite
107720SE	RPK321STC	White/Red	2-1/4 to 3"	Snap-Tite

C&M PART #	MFG PART #	COLOR	PIPE SIZE	STYLE
HOT WATER				
107737HG	RPK423SSA	Black/Yellow	3/4 to 1-1/4"	Self-Stick
107737SA	RPK423SSB	Black/Yellow	1-1/2 to 2"	Self-Stick
107737SB	RPK423SSD	Black/Yellow	2-1/2 to 6"	Self-Stick
107737SC	RPK423SSH	Black/Yellow	8 to 10"	Self-Stick
107741HG	RPK423STA	Black/Yellow	3/4 to 1-1/4"	Snap-Tite
107741SA	RPK423STB	Black/Yellow	1-1/2 to 2"	Snap-Tite
107741SE	RPK423STC	Black/Yellow	2-1/4 to 3"	Snap-Tite
LOW-PRESSURE NATURAL GAS				
107750HG	RPK491SSA	Black/Yellow	3/4 to 1-1/4"	Self-Stick
107750SA	RPK491SSB	Black/Yellow	1-1/2 to 2"	Self-Stick
107750SB	RPK491SSD	Black/Yellow	2-1/2 to 6"	Self-Stick
107750SC	RPK491SSH	Black/Yellow	8 to 10"	Self-Stick
107754HG	RPK491STA	Black/Yellow	3/4 to 1-1/4"	Snap-Tite
107754SA	RPK491STB	Black/Yellow	1-1/2 to 2"	Snap-Tite
107754SE	RPK491STC	Black/Yellow	2-1/4 to 3"	Snap-Tite
NATURAL GAS				
107759HG	RPK523SSA	Black/Yellow	3/4 to 1-1/4"	Self-Stick
107759SA	RPK523SSB	Black/Yellow	1-1/2 to 2"	Self-Stick
107759SB	RPK523SSD	Black/Yellow	2-1/2 to 6"	Self-Stick
107759SC	RPK523SSH	Black/Yellow	8 to 10"	Self-Stick
107763HG	RPK523STA	Black/Yellow	3/4 to 1-1/4"	Snap-Tite
107763SA	RPK523STB	Black/Yellow	1-1/2 to 2"	Snap-Tite
107763SE	RPK523STC	Black/Yellow	2-1/4 to 3"	Snap-Tite
NON-POTABLE WATER				
107772HG	RPK541SSA	Black/Yellow	3/4 to 1-1/4"	Self-Stick
107772SA	RPK541SSB	Black/Yellow	1-1/2 to 2"	Self-Stick
107772SB	RPK541SSD	Black/Yellow	2-1/2 to 6"	Self-Stick
107772SC	RPK541SSH	Black/Yellow	8 to 10"	Self-Stick
107776HG	RPK541STA	Black/Yellow	3/4 to 1-1/4"	Snap-Tite
107776SA	RPK541STB	Black/Yellow	1-1/2 to 2"	Snap-Tite
107776SE	RPK541STC	Black/Yellow	2-1/4 to 3"	Snap-Tite

Continued on Next Page



Pipe Markers (continued)



C&M PART #	MFG PART #	COLOR	PIPE SIZE	STYLE
PLANT AIR				
107781HG	RPK563SSA	Black/Yellow	3/4 to 1-1/4"	Self-Stick
107781SA	RPK563SSB	Black/Yellow	1-1/2 to 2"	Self-Stick
107781SB	RPK563SSD	Black/Yellow	2-1/2 to 6"	Self-Stick
107781SC	RPK563SSH	Black/Yellow	8 to 10"	Self-Stick
107785HG	RPK563STA	Black/Yellow	3/4 to 1-1/4"	Snap-Tite
107785SA	RPK563STB	Black/Yellow	1-1/2 to 2"	Snap-Tite
107785SE	RPK563STC	Black/Yellow	2-1/4 to 3"	Snap-Tite
PLANT WATER				
107790HG	RPK565SSA	White/Green	3/4 to 1-1/4"	Self-Stick
107790SA	RPK565SSB	White/Green	1-1/2 to 2"	Self-Stick
107790SB	RPK565SSD	White/Green	2-1/2 to 6"	Self-Stick
107790SC	RPK565SSH	White/Green	8 to 10"	Self-Stick
107794HG	RPK565STA	White/Green	3/4 to 1-1/4"	Snap-Tite
107794SA	RPK565STB	White/Green	1-1/2 to 2"	Snap-Tite
107794SE	RPK565STC	White/Green	2-1/4 to 3"	Snap-Tite
POTABLE WATER				
107799HG	RPK575SSA	White/Green	3/4 to 1-1/4"	Self-Stick
107799SA	RPK575SSB	White/Green	1-1/2 to 2"	Self-Stick
107799SB	RPK575SSD	White/Green	2-1/2 to 6"	Self-Stick
107799SC	RPK575SSH	White/Green	8 to 10"	Self-Stick
107803HG	RPK575STA	White/Green	3/4 to 1-1/4"	Snap-Tite
107803SA	RPK575STB	White/Green	1-1/2 to 2"	Snap-Tite
107803SE	RPK575STC	White/Green	2-1/4 to 3"	Snap-Tite
RETURN				
107812HG	RPK611SSA	Black/Yellow	3/4 to 1-1/4"	Self-Stick
107812SA	RPK611SSB	Black/Yellow	1-1/2 to 2"	Self-Stick
107812SB	RPK611SSD	Black/Yellow	2-1/2 to 6"	Self-Stick
107812SC	RPK611SSH	Black/Yellow	8 to 10"	Self-Stick
107816HG	RPK611STA	Black/Yellow	3/4 to 1-1/4"	Snap-Tite
107816SA	RPK611STB	Black/Yellow	1-1/2 to 2"	Snap-Tite
107816SE	RPK611STC	Black/Yellow	2-1/4 to 3"	Snap-Tite
SALT WATER				
107821HG	RPK619SSA	White/Green	3/4 to 1-1/4"	Self-Stick
107821SA	RPK619SSB	White/Green	1-1/2 to 2"	Self-Stick
107821SB	RPK619SSD	White/Green	2-1/2 to 6"	Self-Stick
107821SC	RPK619SSH	White/Green	8 to 10"	Self-Stick
107825HG	RPK619STA	White/Green	3/4 to 1-1/4"	Snap-Tite
107825SA	RPK619STB	White/Green	1-1/2 to 2"	Snap-Tite
107825SE	RPK619STC	White/Green	2-1/4 to 3"	Snap-Tite

C&M PART #	MFG PART #	COLOR	PIPE SIZE	STYLE
SUPPLY				
107842HG	RPK689SSA	Black/Yellow	3/4 to 1-1/4"	Self-Stick
107842SA	RPK689SSB	Black/Yellow	1-1/2 to 2"	Self-Stick
107842SB	RPK689SSD	Black/Yellow	2-1/2 to 6"	Self-Stick
107842SC	RPK689SSH	Black/Yellow	8 to 10"	Self-Stick
107846HG	RPK689STA	Black/Yellow	3/4 to 1-1/4"	Snap-Tite
107846SA	RPK689STB	Black/Yellow	1-1/2 to 2"	Snap-Tite
107846SE	RPK689STC	Black/Yellow	2-1/4 to 3"	Snap-Tite
TREATED WATER				
107855HG	RPK711SSA	White/Green	3/4 to 1-1/4"	Self-Stick
107855SA	RPK711SSB	White/Green	1-1/2 to 2"	Self-Stick
107855SB	RPK711SSD	White/Green	2-1/2 to 6"	Self-Stick
107855SC	RPK711SSH	White/Green	8 to 10"	Self-Stick
107859HG	RPK711STA	White/Green	3/4 to 1-1/4"	Snap-Tite
107859SA	RPK711STB	White/Green	1-1/2 to 2"	Snap-Tite
107859SE	RPK711STC	White/Green	2-1/4 to 3"	Snap-Tite
WASTEWATER				
107864HG	RPK729SSA	Black/Yellow	3/4 to 1-1/4"	Self-Stick
107864SA	RPK729SSB	Black/Yellow	1-1/2 to 2"	Self-Stick
107864SB	RPK729SSD	Black/Yellow	2-1/2 to 6"	Self-Stick
107864SC	RPK729SSH	Black/Yellow	8 to 10"	Self-Stick
107868HG	RPK729STA	Black/Yellow	3/4 to 1-1/4"	Snap-Tite
107868SA	RPK729STB	Black/Yellow	1-1/2 to 2"	Snap-Tite
107868SE	RPK729STC	Black/Yellow	2-1/4 to 3"	Snap-Tite
WATER				
107873HG	RPK735SSA	White/Green	3/4 to 1-1/4"	Self-Stick
107873SA	RPK735SSB	White/Green	1-1/2 to 2"	Self-Stick
107873SB	RPK735SSD	White/Green	2-1/2 to 6"	Self-Stick
107873SC	RPK735SSH	White/Green	8 to 10"	Self-Stick
107877HG	RPK735STA	White/Green	3/4 to 1-1/4"	Snap-Tite
107877SA	RPK735STB	White/Green	1-1/2 to 2"	Snap-Tite
107877SE	RPK735STC	White/Green	2-1/4 to 3"	Snap-Tite



Sign Hardware & Accessories



Ensure your safety signs stay in place with these accessories.

C&M PART #	MFG PART #	DESCRIPTION
FENCE BRACKET		
108495	HSR270	Fence Sign Holder Bracket, Galvanized Steel
POSTS & HARDWARE		
10849068WW	HSP106	Standard Weight U-Channel Post, Green Finish, 6 ft
108490C4WW	HSP107	Standard Weight U-Channel Post, Galvanized Finish, 6 ft
108492681F	HSP108	Heavy Weight U-Channel Post, Green Finish, 8 ft
108492C41F	HSP109	Heavy Weight U-Channel Post, Galvanized Finish, 8 ft
108494	HFN208	Mounting Bolts and Nuts - (2)Bolts, (2)Nuts & (4)Washers, 2" X 5/16"
SIGN STAND		
108489	HSP820	Blockade Versatile Sign Stand, 6 ft

SUGGESTED PRODUCTS

Radians® Radwear Silver Series™ High-Visibility Knit Dipped Gloves

The Silver Series High-Visibility Gloves have a 15-gauge nylon shell. The elastic cuff provides a comfortable, slip-on fit while the micro-foam dipped latex palm provides durability and a slip-free grip. Sold as a pair.



FEATURES & BENEFITS

- Meets EN 388:2003 standards for abrasion, cuts, tear and puncture (2 1 3 1)
- Highly visible neon color—visible even during daytime
- Micro-foam coated latex palm offers a slip-free grip

SPECIFICATIONS

MATERIAL	13-Gauge Nylon Shell
PALM	Foam Latex
CUFF STYLE	Seamless Comfort Cuff

CERTIFICATIONS

- EN 388 Standards

C&M PART #	MFG PART #	SIZE
100425MD	RWG10M	M
100425LG	RWG10L	L
100425XL	RWG10XL	XL

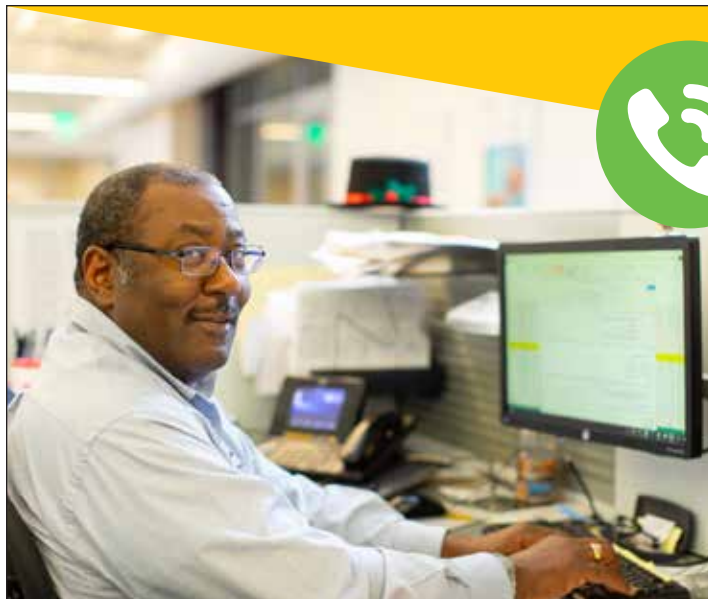

TALK TO AN EXPERT TODAY!

Need application advice or help to locate a part? Contact our technical specialists, they are here to help!

1-888-885-2673



Workplace Safety Signage

Reduce workplace accidents and injuries with the proper use of Workplace Safety Signs. These safety signs are regulated by both the Occupational Safety and Health Administration and the American National Standards Institute. These organizations have established rules and regulations to ensure safety signs are easily identifiable, relevant and posted in appropriate workplace locations.



C&M PART #	MFG PART #	DESCRIPTION	SIZE (H x W)	COLOR	MATERIAL
ADA BRAILLE TACTILE					
10866519881H	PAD902BU	Exit Route	8" x 8"	Blue	Plastic
10866517881H	PAD902BK	Exit Route	8" x 8"	Black	Plastic
1086751988WF	PAD324BU	Exit	3" x 6"	Blue	Plastic
1086751788WF	PAD324BK	Exit	3" x 6"	Black	Plastic
10866719881H	PAD901BU	Exit Stair Down	8" x 8"	Blue	Plastic
10866717881H	PAD901BK	Exit Stair Down	8" x 8"	Black	Plastic
10868319881L	PAD119BU	Exit Stairs	9" x 6"	Blue	Plastic
10868317881L	PAD119BK	Exit Stairs	9" x 6"	Black	Plastic
10866919881H	PAD134BU	Wheelchair	8" x 8"	Blue	Plastic
10866917881H	PAD134BK	Wheelchair	8" x 8"	Black	Plastic
10867119881H	PAD923BU	Women	8" x 8"	Blue	Plastic
10867117881H	PAD923BK	Women	8" x 8"	Black	Plastic
10867319881H	PAD921BU	Men	8" x 8"	Blue	Plastic
10867317881H	PAD921BK	Men	8" x 8"	Black	Plastic
10868719881L	PAD110BU	Women	9" x 6"	Blue	Plastic
10868717881L	PAD110BK	Women	9" x 6"	Black	Plastic
10868519881L	PAD107BU	Men	9" x 6"	Blue	Plastic
10868517881L	PAD107BK	Men	9" x 6"	Black	Plastic
10868919881L	PAD122BU	Family Restrooms	9" x 6"	Blue	Plastic
10868917881L	PAD122BK	Family Restrooms	9" x 6"	Black	Plastic
10869119881L	PAD127BU	Employee Restroom	9" x 6"	Blue	Plastic
10869117881L	PAD127BK	Employee Restroom	9" x 6"	Black	Plastic
10867919881L	PAD121BU	All Gender Restroom	9" x 6"	Blue	Plastic
10867917881L	PAD121BK	All Gender Restroom	9" x 6"	Black	Plastic
10869319881L	PAD126BU	Baby Changing Area	9" x 6"	Blue	Plastic
10869317881L	PAD126BK	Baby Changing Area	9" x 6"	Black	Plastic
10868119881L	PAD123BU	Shower	9" x 6"	Blue	Plastic
10868117881L	PAD123BK	Shower	9" x 6"	Black	Plastic
10869519881L	PAD128BU	Elevator	9" x 6"	Blue	Plastic
10869517881L	PAD128BK	Elevator	9" x 6"	Black	Plastic
1086771988YR	PAD940BU	Case of Fire	12" x 6"	Blue	Plastic
1086771788YR	PAD940BK	Case of Fire	12" x 6"	Black	Plastic
10869719881L	PAD129BU	Storm Shelter	9" x 6"	Blue	Plastic
10869717881L	PAD129BK	Storm Shelter	9" x 6"	Black	Plastic

C&M PART #	MFG PART #	DESCRIPTION	SIZE (H x W)	COLOR	MATERIAL
AED					
108878BI881B	PSP610	3D AED	6" x 5"	White/Black/Red	Plastic
108878BI881H	PSP721	90D AED	8" x 8"	White/Black/Red	Plastic
108880BI881B	PSP609	3D AED	6" x 5"	White/Black/Red	Plastic
108880BI881H	PSP708	90D AED	8" x 8"	White/Black/Red	Plastic

ADA Braille Tactile



Continued on Next Page

Workplace Safety Signage (continued)

Chemical ID and Hazard

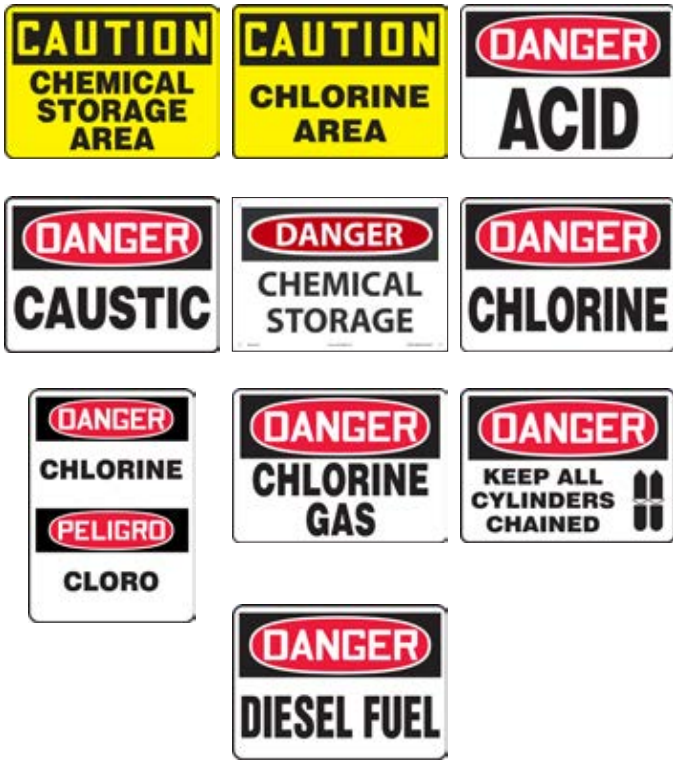

California Title 24 Restroom



C&M PART #	MFG PART #	DESCRIPTION	SIZE (H x W)	COLOR	MATERIAL
CALIFORNIA TITLE 24 RESTROOM					
1087011988YO	PAD706BU	Restroom	12" x 12"	Blue	Plastic
1087011788YO	PAD706BK	Restroom	12" x 12"	Black	Plastic
1087031988YO	PAD714BU	Women	12" x 12"	Blue	Plastic
1087031788YO	PAD714BK	Women	12" x 12"	Black	Plastic
1086991988YO	PAD710BU	Men	12" x 12"	Blue	Plastic
1086991788YO	PAD710BK	Men	12" x 12"	Black	Plastic
1087051988YO	PAD705BU	Gender Neutral	12" x 12"	Blue	Plastic
1087051788YO	PAD705BK	Gender Neutral	12" x 12"	Black	Plastic

C&M PART #	MFG PART #	DESCRIPTION	SIZE (H x W)	COLOR	MATERIAL
CHEMICAL ID AND HAZARD					
110228BJ88ID	MCHL652VP	Caution Chemical Storage	7" x 10"	Yellow/Black	Plastic
110228BJ88YF	MCHL668VP	Caution Chemical Storage	10" x 14"	Yellow/Black	Plastic
110240BJ88ID	MCHL798VS	Caution Chlorine Area	7" x 10"	Yellow/Black	Vinyl
110240BJ88YF	MCHL704VP	Caution Chlorine Area	10" x 14"	Yellow/Black	Plastic
110222BISCID	MCHL189VS	Danger Acid	7" x 10"	White/Black/Red	Vinyl
110222BI88ID	MCHL189VP	Danger Acid	7" x 10"	White/Black/Red	Plastic
110222BISCYF	MCHL190VS	Danger Acid	10" x 14"	White/Black/Red	Vinyl
110222BI88YF	MCHL190VP	Danger Acid	10" x 14"	White/Black/Red	Plastic
110226BISCID	MCHL075VS	Danger Caustic	7" x 10"	White/Black/Red	Vinyl
110226BI88ID	MCHL010VP	Danger Caustic	7" x 10"	White/Black/Red	Plastic
109003BISCID	MCHL191VS	Danger Chemical Storage	7" x 10"	White/Black/Red	Vinyl
109003BI88YF	MCHL192VP	Danger Chemical Storage	10" x 14"	White/Black/Red	Plastic
110230BISCID	MCHL193VS	Danger Chlorine	7" x 10"	White/Black/Red	Vinyl
110230BI88ID	MCHL193VP	Danger Chlorine	7" x 10"	White/Black/Red	Plastic
110230BISCYF	MCHL194VS	Danger Chlorine	10" x 14"	White/Black/Red	Vinyl
110230BI88YF	MCHL194VP	Danger Chlorine	10" x 14"	White/Black/Red	Plastic
110234BISCYT	SBMCHL194VS	Danger Chlorine (Bilingual)	14" x 10"	White/Black/Red	Vinyl
110234BI88YT	SBMCHL194VP	Danger Chlorine (Bilingual)	14" x 10"	White/Black/Red	Plastic
110234BI09YT	SBMCHL194VA	Danger Chlorine (Bilingual)	14" x 10"	White/Black/Red	Aluminum
110237BISCYF	MCHL184VS	Danger Chlorine Gas	7" x 10"	White/Black/Red	Vinyl
110237BI88YF	MCHL184VP	Danger Chlorine Gas	10" x 14"	White/Black/Red	Plastic
110237BI09YF	MCHL184VA	Danger Chlorine Gas	10" x 14"	White/Black/Red	Aluminum
110254BI88YF	MCPG027VP	Danger Cylinders Chained	10" x 14"	White/Black/Red	Plastic
110242BISCID	MCHL224VS	Danger Diesel Fuel	7" x 10"	White/Black/Red	Vinyl
110242BISCYF	MCHL226VS	Danger Diesel Fuel	10" x 14"	White/Black/Red	Vinyl
110242BI88YF	MCHL226VP	Danger Diesel Fuel	10" x 14"	White/Black/Red	Plastic

Continued on Next Page

Workplace Safety Signage (continued)

Chemical ID and Hazard



C&M PART #	MFG PART #	DESCRIPTION	SIZE (H x W)	COLOR	MATERIAL
CHEMICAL ID AND HAZARD (CONTINUED)					
110245BISCID	MCHL228VS	Danger Flammable	7" x 10"	White/Black/Red	Vinyl
110245BI88ID	MCHL228VP	Danger Flammable	7" x 10"	White/Black/Red	Plastic
110245BI09ID	MCHL228VA	Danger Flammable	7" x 10"	White/Black/Red	Aluminum
110245BISCYF	MCHL231VS	Danger Flammable	10" x 14"	White/Black/Red	Vinyl
110245BI88YF	MCHL231VP	Danger Flammable	10" x 14"	White/Black/Red	Plastic
110245BI09YF	MCHL231VA	Danger Flammable	10" x 14"	White/Black/Red	Aluminum
109008BISCID	MCHG101VS	Danger Flammable Liquids	7" x 10"	White/Black/Red	Vinyl
109008BISCYF	MCHG102VS	Danger Flammable Liquids	10" x 14"	White/Black/Red	Vinyl
110251BI09ID	MCHL241VA	Danger Gasoline	7" x 10"	White/Black/Red	Aluminum
110251BI09YF	MCHL245VA	Danger Gasoline	10" x 14"	White/Black/Red	Aluminum
109005BISCID	MCPG019VS	Danger Hot	7" x 10"	White/Black/Red	Vinyl
109005BI88ID	MCPG019VP	Danger Hot	7" x 10"	White/Black/Red	Plastic
110253BI88YF	MCHG104VP	Danger Hydrochloric Acid	10" x 14"	White/Black/Red	Plastic
109007BISCID	MCHL168VS	Danger Oxygen	7" x 10"	White/Black/Red	Vinyl
109017BI09ID	MCPG025VA	Danger Propane/No Smoking	7" x 10"	White/Black/Red	Aluminum
110255BISCYF	MCHG081VS	Danger Sodium Hypochlorite	10" x 14"	White/Black/Red	Vinyl
110255BI88YF	MCHG081VP	Danger Sodium Hypochlorite	10" x 14"	White/Black/Red	Plastic
110255BI09YF	MCHG081VA	Danger Sodium Hypochlorite	10" x 14"	White/Black/Red	Aluminum

C&M PART #	MFG PART #	DESCRIPTION	SIZE (H x W)	COLOR	MATERIAL
CHEMICAL ID AND HAZARD (CONTINUED)					
110258BISCID	MCHL077VS	Danger Sulfuric Acid	7" x 10"	White/Black/Red	Vinyl
110258BISCYF	MCHG014VS	Danger Sulfuric Acid	10" x 14"	White/Black/Red	Vinyl
110258BI88ID	MCHL077VP	Danger Sulfuric Acid	7" x 10"	White/Black/Red	Plastic
110258BI88YF	MCHG014VP	Danger Sulfuric Acid	10" x 14"	White/Black/Red	Plastic
109010BISCID	MWLD009VS	Danger Welding Area	7" x 10"	White/Black/Red	Vinyl
109010BI88ID	MWLD009VP	Danger Welding Area	7" x 10"	White/Black/Red	Plastic
109010BI09ID	MWLD009VA	Danger Welding Area	7" x 10"	White/Black/Red	Aluminum
109021AYSCID	MCPG593VS	Empty Cylinder	7" x 10"	Red/White	Vinyl
109020ALSCID	MCPG595VS	Full Cylinder	7" x 10"	Green/White	Vinyl
110262AI88ID	MCPG802VP	Notice Empty Cylinders	7" x 10"	White/Black/Blue	Plastic
110262AI88YF	MCPG805VP	Notice Empty Cylinders	10" x 14"	White/Black/Blue	Plastic
110262AI09YF	MCPG805VA	Notice Empty Cylinders	10" x 14"	White/Black/Blue	Aluminum
110265AI88ID	MCPG804VP	Notice Full Cylinders	7" x 10"	White/Black/Blue	Plastic
110265AI88YF	MCPG816VP	Notice Full Cylinders	10" x 14"	White/Black/Blue	Plastic
110265AI09YF	MCPG816VA	Notice Full Cylinders	10" x 14"	White/Black/Blue	Aluminum
109018BJSCID	MCHL563VS	Spill Kit Station	7" x 10"	Yellow/Black	Vinyl
109018BJ88YF	MCHL567VP	Spill Kit Station	10" x 14"	Yellow/Black	Plastic

Continued on Next Page



Workplace Safety Signage (continued)

Compliance Center



108850SF09ZR

108850A709ZR

108850D509ZR



108850D709ZR

108848D509ZB

108848AS09ZB



108856SF88YC

108856AS88YC

108850AS09ZR

108850AH09ZR



108858AS88IG

Confined Space



C&M PART #	MFG PART #	DESCRIPTION	SIZE (H x W)	COLOR	MATERIAL
CONFINED SPACE					
108584BI09ID	MCSP140VA	Authorized Personnel Only	7" x 10"	White/Black/Red	Aluminum
108584BI88ID	MCSP140VP	Authorized Personnel Only	7" x 10"	White/Black/Red	Plastic
108584BISCID	MCSP140VS	Authorized Personnel Only	7" x 10"	White/Black/Red	Vinyl
108584BI88YF	MCSP141VP	Authorized Personnel Only	10" x 14"	White/Black/Red	Plastic
108584BISCYF	MCSP141VS	Authorized Personnel Only	10" x 14"	White/Black/Red	Vinyl
108579BI09ID	MCSP116VA	Confined Space	7" x 10"	White/Black/Red	Aluminum
108579BI88ID	MCSP116VP	Confined Space	7" x 10"	White/Black/Red	Plastic
108579BISCID	MCSP116VS	Confined Space	7" x 10"	White/Black/Red	Vinyl
108579BI88YF	MCSP002VP	Confined Space	10" x 14"	White/Black/Red	Plastic
108579BISCYF	MCSP002VS	Confined Space	10" x 14"	White/Black/Red	Vinyl
108615AQC7ID	CSM011	Confined Space	7" x 10"	White/Black/Red	Magnetic
108598BI09ID	MCSP133VA	Confined Space Permit Only	7" x 10"	White/Black/Red	Aluminum
108598BI88ID	MCSP133VP	Confined Space Permit Only	7" x 10"	White/Black/Red	Plastic
108598BISCID	MCSP133VS	Confined Space Permit Only	7" x 10"	White/Black/Red	Vinyl
108598BI09YF	MCSP134VA	Confined Space Permit Only	10" x 14"	White/Black/Red	Aluminum
108598BI88YF	MCSP134VP	Confined Space Permit Only	10" x 14"	White/Black/Red	Plastic
108598BISCYF	MCSP134VS	Confined Space Permit Only	10" x 14"	White/Black/Red	Vinyl
108616AQC7ID	CSM005	Confined Space Permit Only	7" x 10"	White/Black/Red	Magnetic
108595BI88ID	MCSP122VP	Confined Space Permit Req'd.	7" x 10"	White/Black/Red	Plastic
108595BISCID	MCSP122VS	Confined Space Permit Req'd.	7" x 10"	White/Black/Red	Vinyl
108595BISCYF	MCSP026VS	Confined Space Permit Req'd.	10" x 14"	White/Black/Red	Vinyl

C&M PART #	MFG PART #	DESCRIPTION	SIZE (H x W)	COLOR	MATERIAL
COMPLIANCE CENTER					
108850SF0J09	SBZRS313	Right-to-Know Board-Bilingual	25" x 20"	Yellow/White/Red	Aluminum
108850A70K09	ZRS326	Right-to-Know Center	20" x 15"	Yellow/White/Red	Aluminum
108850D50K09	ZRS313	Right-to-Know Center Board	20" x 15"	Yellow/White/Red	Aluminum
108850D70K09	SBZRS326	Right-to-Know Center-Bilingual	20" x 15"	Yellow/White/Red	Aluminum
108848D509	ZRS348	Right-to-Know Station Board	18" x 24"	White/Blue/Red	Aluminum
10884809ZB	ZRS347	Right-to-Know Station Kit	18" x 24"	White/Blue/Red	Aluminum
108856SF88YC	ZRS632	Safety Data Sheet Binder	1.5" Thick	White/Red	Plastic
108856BK88YC	ZRS641	Safety Data Sheet Binder	1.5" Thick	Yellow/Red	Plastic
108850SF0K09	ZRS407	SDS Information Center	20" x 15"	White/Red	Aluminum
108850AY0K09	ZRS408	SDS Information Center	20" x 15"	White/Red	Aluminum
108858BK88IG	PSP768	3D SDS Projection Sign	8" x 12"	Yellow/Red	Plastic

Continued on Next Page



Workplace Safety Signage (continued)

Construction Site



Confined Space



C&M PART #	MFG PART #	DESCRIPTION	SIZE (H x W)	COLOR	MATERIAL
CONFINED SPACE (CONTINUED)					
108589BI091D	MCSP006VA	Do Not Enter	7" x 10"	White/Black/Red	Aluminum
108589BI881D	MCSP006VP	Do Not Enter	7" x 10"	White/Black/Red	Plastic
108589BISC1D	MCSP006VS	Do Not Enter	7" x 10"	White/Black/Red	Vinyl
108589BI09YF	MCSP230VA	Do Not Enter	10" x 14"	White/Black/Red	Aluminum
108589BI88YF	MCSP230VP	Do Not Enter	10" x 14"	White/Black/Red	Plastic
108589BISCYF	MCSP230VS	Do Not Enter	10" x 14"	White/Black/Red	Vinyl
108610BISCYT	SBMCSP134VS	Authorized Personnel Only (Bilingual)	14" x 10"	White/Black/Red	Vinyl
108609BISCYT	SBMCSP141VS	Authorized Personnel Only (Bilingual)	14" x 10"	White/Black/Red	Vinyl
108608BISCYT	SBMCSP230VS	Authorized Personnel Only (Bilingual)	14" x 10"	White/Black/Red	Vinyl
108604BI091D	MCSP007VA	Permit Req'd Do Not Enter	7" x 10"	White/Black/Red	Aluminum
108604BISC1D	MCSP007VS	Permit Req'd Do Not Enter	7" x 10"	White/Black/Red	Vinyl
108604BI88YF	MCSP058VP	Permit Req'd Do Not Enter	10" x 14"	White/Black/Red	Plastic
108604BISCYF	MCSP058VS	Permit Req'd Do Not Enter	10" x 14"	White/Black/Red	Vinyl

C&M PART #	MFG PART #	DESCRIPTION	SIZE (H x W)	COLOR	MATERIAL
CONSTRUCTION SITE					
108563BI88YF	MADM003VP	Authorized Personnel Only	10" x 14"	White/Black/Red	Plastic
108556BI881D	MELC111VP	Buried Cable	7" x 10"	White/Black/Red	Plastic
108556BI88YF	MELC112VP	Buried Cable	10" x 14"	White/Black/Red	Plastic
108558BI881D	MCRT127VP	Construction Area	7" x 10"	White/Black/Red	Plastic
108558BI88YF	MCRT135VP	Construction Area	10" x 14"	White/Black/Red	Plastic
108560BI881D	MCRT101VP	Construction Area Keep Out	7" x 10"	White/Black/Red	Plastic
108560BI88YF	MADM014VP	Construction Area Keep Out	10" x 14"	White/Black/Red	Plastic
108560BI09YF	MADM014VA	Construction Area Keep Out	10" x 14"	White/Black/Red	Aluminum
108565BI881D	MCRT147VP	Fall Hazard (Graphic)	7" x 10"	White/Black/Red	Plastic
108565BI88YF	MCSP188VP	Fall Hazard (Graphic)	10" x 14"	White/Black/Red	Plastic
108572BI88YT	SBMADM014VP	Keep Out (Bilingual)	14" x 10"	White/Black/Red	Plastic
108572BI09YT	SBMADM014VA	Keep Out (Bilingual)	14" x 10"	White/Black/Red	Aluminum
108571BI09YF	SBMCRT016VA	Men Work Above (Bilingual)	10" x 14"	White/Black/Red	Aluminum
108564BI88YF	MCRT122VP	No Trespassing	10" x 14"	White/Black/Red	Plastic
108567BI88YF	MCRT009VP	Open Hole	10" x 14"	White/Black/Red	Plastic
108568BI88YF	MCRT010VP	Open Pit	10" x 14"	White/Black/Red	Plastic
108569BISC1D	MEQM095VS	Watch for Falling Material	7" x 10"	White/Black/Red	Vinyl
108569BI88YF	MEQM098VP	Watch for Falling Material	10" x 14"	White/Black/Red	Plastic

Continued on Next Page



Workplace Safety Signage (continued)

Cross Barrier



108618AQ88WU

108619AQ88WU

Door



Electrical Hazard



C&M PART #	MFG PART #	DESCRIPTION	SIZE (H x W)	COLOR	MATERIAL
CROSS BARRIER					
108618AQ88WU	CXB631	Confined Space - Permit	42" x 42"	White/Black/Red	Plastic
108619AQ88WU	CXB635	Confined Space - Permit	42" x 42"	White/Black/Red	Plastic
DOOR					
108551ARSCID	MABR603VS	Open Door Slowly	7" x 10"	Yellow/Black	Vinyl
108552ANSCID	MABR823VS	Keep this Door Closed	7" x 10"	White/Black/Blue	Vinyl
108552AN88ID	MABR823VP	Keep this Door Closed	7" x 10"	White/Black/Blue	Plastic
108552ANSCYF	MABR825VS	Keep this Door Closed	10" x 14"	White/Black/Blue	Vinyl
ELECTRICAL HAZARD					
108954BISCID	MELC058VS	480 Volts	7" x 10"	White/Black/Red	Vinyl
108954BI88ID	MELC058VP	480 Volts	7" x 10"	White/Black/Red	Plastic
108954BI09ID	MELC058VA	480 Volts	7" x 10"	White/Black/Red	Aluminum
108954BISCYF	MELC059VS	480 Volts	10" x 14"	White/Black/Red	Vinyl
108954BI88YF	MELC059VP	480 Volts	10" x 14"	White/Black/Red	Plastic
108954BI09YF	MELC059VA	480 Volts	10" x 14"	White/Black/Red	Aluminum
108960BISCID	MELC113VS	High Voltage	7" x 10"	White/Black/Red	Vinyl
108960BI88ID	MELC113VP	High Voltage	7" x 10"	White/Black/Red	Plastic
108960BI09ID	MELC113VA	High Voltage	7" x 10"	White/Black/Red	Aluminum
108960BISCYF	MELC114VS	High Voltage	10" x 14"	White/Black/Red	Vinyl
108960BI88YF	MELC114VP	High Voltage	10" x 14"	White/Black/Red	Plastic
108960BI09YF	MELC114VA	High Voltage	10" x 14"	White/Black/Red	Aluminum
108966BISCYT	SBMELC114VS	High Voltage (Bilingual)	14" x 10"	White/Black/Red	Vinyl
108966BI88YT	SBMELC114VP	High Voltage (Bilingual)	14" x 10"	White/Black/Red	Plastic
108966BI09YT	SBMELC114VA	High Voltage (Bilingual)	14" x 10"	White/Black/Red	Aluminum

C&M PART #	MFG PART #	DESCRIPTION	SIZE (H x W)	COLOR	MATERIAL
ELECTRICAL HAZARD (CONTINUED)					
108969BISCYT	SBMELC187VS	Auth. Personnel (Bilingual)	14" x 10"	White/Black/Red	Vinyl
108969BI88YT	SBMELC187VP	Auth. Personnel (Bilingual)	14" x 10"	White/Black/Red	Plastic
108969BI09YT	SBMELC187VA	Auth. Personnel (Bilingual)	14" x 10"	White/Black/Red	Aluminum
108972BJSCID	MELC639VS	Area in Front Electrical Panel	7" x 10"	Yellow/Black	Vinyl
108972BJ88ID	MELC639VP	Area in Front Electrical Panel	7" x 10"	Yellow/Black	Plastic
108972BJ09ID	MELC639VA	Area in Front Electrical Panel	7" x 10"	Yellow/Black	Aluminum
108972BJSCYF	MELC625VS	Area in Front Electrical Panel	10" x 14"	Yellow/Black	Vinyl
108972BJ88YF	MELC625VP	Area in Front Electrical Panel	10" x 14"	Yellow/Black	Plastic
108972BJ09YF	MELC625VA	Area in Front Electrical Panel	10" x 14"	Yellow/Black	Aluminum
108978AISCID	MELC80IVS	Electrical Room, No Storage	7" x 10"	White/Black/Blue	Vinyl
108978AI88ID	MELC80IVP	Electrical Room, No Storage	7" x 10"	White/Black/Blue	Plastic
108978AI09ID	MELC80IVA	Electrical Room, No Storage	7" x 10"	White/Black/Blue	Aluminum
108978AISCYF	MELC804VS	Electrical Room, No Storage	10" x 14"	White/Black/Blue	Vinyl
108978AI88YF	MELC804VP	Electrical Room, No Storage	10" x 14"	White/Black/Blue	Plastic
108978AI09YF	MELC804VA	Electrical Room, No Storage	10" x 14"	White/Black/Blue	Aluminum

Continued on Next Page



Workplace Safety Signage (continued)

Emergency Exit



C&M PART #	MFG PART #	DESCRIPTION	SIZE (H x W)	COLOR	MATERIAL
EMERGENCY EXIT					
108714SFSCID	MEXT591VS	Emergency Exit Door Alarm	7" x 10"	White/Red	Vinyl
108714SF88ID	MEXT591VP	Emergency Exit Door Alarm	7" x 10"	White/Red	Plastic
108714SFSCYF	MEXT932VS	Emergency Exit Door Alarm	10" x 14"	White/Red	Vinyl
108714SF88YF	MEXT932VP	Emergency Exit Door Alarm	10" x 14"	White/Red	Plastic
108707SFSCID	MEXT584VS	Emergency Exit Only	7" x 10"	White/Red	Vinyl
108707SF88ID	MEXT584VP	Emergency Exit Only	7" x 10"	White/Red	Plastic
108707SFSCYF	MEXT918VS	Emergency Exit Only	10" x 14"	White/Red	Vinyl
108707SF88YF	MEXT918VP	Emergency Exit Only	10" x 14"	White/Red	Plastic
108711AY88ID	MEXT586VP	Emergency Exit Only	7" x 10"	Red/White	Plastic
108711AYSCYF	MEXT441VS	Emergency Exit Only	10" x 14"	Red/White	Vinyl
108711AY88YF	MEXT441VP	Emergency Exit Only	10" x 14"	Red/White	Plastic
108718SFSCID	MADC531VS	Exit	7" x 10"	White/Red	Vinyl
108718SF88ID	MADC531VP	Exit	7" x 10"	White/Red	Plastic
108718SFSCYF	MEXT906VS	Exit	10" x 14"	White/Red	Vinyl
108718SF88YF	MEXT906VP	Exit	10" x 14"	White/Red	Plastic
108718SF09YF	MEXT906VA	Exit	10" x 14"	White/Red	Aluminum
108718AOSCYF	MADC501GF	Exit	10" x 14"	White/Red	Glow Vinyl
108740SFSCYF	SBMEXT906MVS	Exit (Bilingual)	10" x 14"	White/Red	Vinyl
108724SFSCYF	MADC532VS	Exit (Left Arrow)	10" x 14"	White/Red	Vinyl
108724SF88YF	MADC532VP	Exit (Left Arrow)	10" x 14"	White/Red	Plastic
108724AOSCYF	MADC533GF	Exit (Left Arrow)	10" x 14"	White/Red	Lumi-Glow
108727SFSCYF	MADC534VS	Exit (Right Arrow)	10" x 14"	White/Red	Vinyl
108727SF88YF	MADC534VP	Exit (Right Arrow)	10" x 14"	White/Red	Plastic
108727AOSCYF	MADC535GF	Exit (Right Arrow)	10" x 14"	White/Red	Lumi-Glow
108738SFSCYF	MADC529VS	No Exit	10" x 14"	White/Red	Vinyl
108738SF88YF	MADC529VP	No Exit	10" x 14"	White/Red	Plastic
108732SFSCID	MEXT910VS	Not an Exit	7" x 10"	White/Red	Vinyl
108732SF88ID	MEXT910VP	Not an Exit	7" x 10"	White/Red	Plastic
108732SFSCYF	MEXT911VS	Not an Exit	10" x 14"	White/Red	Vinyl
108732SF88YF	MEXT911VP	Not an Exit	10" x 14"	White/Red	Plastic
108732AOSCID	MEXT916GF	Not an Exit	7" x 10"	White/Red	Lumi-Glow
108732AO88ID	MEXT916GP	Not an Exit	7" x 10"	White/Red	Plastic
108741SFSCYF	SBMEXT911MVS	Not an Exit (Bilingual)	10" x 14"	White/Red	Vinyl
108730SFSCYF	MADC530VS	To Exit	10" x 14"	White/Red	Vinyl
108730SF88YF	MADC530VP	To Exit	10" x 14"	White/Red	Plastic

Emergency Shower & Eyewash



C&M PART #	MFG PART #	DESCRIPTION	SIZE (H x W)	COLOR	MATERIAL
EMERGENCY SHOWER & EYEWASH					
108859SE881B	PSP601	3D Eye Wash	6" x 5"	White/Green	Plastic
108859SE881H	PSP702	90D Eye Wash	8" x 8"	White/Green	Plastic
108861ALSCID	MFSD987VS	Eye Wash Station	7" x 10"	Green/White	Vinyl
108861AL88ID	MFSD987VP	Eye Wash Station	7" x 10"	Green/White	Plastic
108861AL88YF	MFSD988VP	Eye Wash Station	10" x 14"	Green/White	Plastic
108864SE881B	PSP608	3D Emergency Shower	6" x 5"	White/Green	Plastic
108864SE881H	PSP710	90D Emergency Shower	8" x 8"	White/Green	Plastic
108866AL88ZD	PSP369	3D Eye Wash	18" x 4"	White/Green	Plastic
108867AL88ZD	PSP437	90D Eye Wash	18" x 4"	White/Green	Plastic
108868SE88YZ	MFSD996VP	Emergency Shower/ Eye Wash	17" x 7"	White/Green	Plastic
108869SE88YT	SBMFSR502VP	Emergency Shower/ Eye Wash	14" x 10"	White/Green	Plastic

Continued on Next Page



Workplace Safety Signage (continued)

Evacuation & Shelter



Evacuation Map Holders



10874539881J

Fire Extinguishers



108759SFSCYQ

108759SFSCZD

108759SFSCZX



108770SF88ZD

108770AO88ZX



108775AY881B

108775AY881H



108777AY881B

108777AY881H

108777AO881B

108777AO881H

C&M PART #	MFG PART #	DESCRIPTION	SIZE (H x W)	COLOR	MATERIAL
EVACUATION & SHELTER					
108746AO881B	PSP141	3D Shelter Area	6" x 5"	White/Black/Green	Plastic
108746AO881B	PSP352	3D Shelter Area	6" x 5"	White/Black/Green	Lumi-glow
108748BGSCYG	MFEX541VS	Shelter Area	10" x 7"	Green/Black/White	Vinyl
108748BG88YG	MFEX541VP	Shelter Area	10" x 7"	Green/Black/White	Plastic
108748BG09YG	MFEX541VA	Shelter Area	10" x 7"	Green/Black/White	Aluminum
108748BGSCYT	MFEX524VS	Shelter Area	14" x 10"	Green/Black/White	Vinyl
108748BG88YT	MFEX524VP	Shelter Area	14" x 10"	Green/Black/White	Plastic
108748BG09YT	MFEX524VA	Shelter Area	14" x 10"	Green/Black/White	Aluminum
EVACUATION MAP HOLDERS					
108743AO881J	DTA202	Map Holder	8-1/2" x 11"	Transparent	Lumi-glow
108743AO881Y	DTA204	Map Holder	11" x 17"	Transparent	Lumi-glow
10874239881J	DTA235	Map Holder	8-1/2" x 11"	Transparent	Plastic
10874539881J	DTA213	Map Holder Inserts	8-1/2" x 11"	Transparent	Film
FIRE EXTINGUISHERS					
108758BISCZD	MFXG584VS	Fire Extinguisher Keep Clear	18" x 4"	Red/White	Vinyl
108759SFSCYQ	MFXG543VS	Fire Extinguisher	12" x 4"	Red/White	Vinyl
108759SF88YQ	MFXG543VP	Fire Extinguisher	12" x 4"	Red/White	Plastic
108759SF09YQ	MFXG543VA	Fire Extinguisher	12" x 4"	Red/White	Aluminum
108759SFSCZD	MFXG545VS	Fire Extinguisher	18" x 4"	Red/White	Vinyl
108759SF88ZD	MFXG545VP	Fire Extinguisher	18" x 4"	Red/White	Plastic
108759SF09ZD	MFXG545VA	Fire Extinguisher	18" x 4"	Red/White	Aluminum
108759SFSCZX	MFXG918VS	Fire Extinguisher	24" x 4"	Red/White	Vinyl
108759SF88ZX	MFXG918VP	Fire Extinguisher	24" x 4"	Red/White	Plastic
108767BISCZD	MFXG580VS	Fire Extinguisher Do Not Block	18" x 4"	Red/White	Vinyl
108767BI88ZD	MFXG580VP	Fire Extinguisher Do Not Block	18" x 4"	Red/White	Plastic
108769BI88ZD	SBMFXG934VP	Do Not Block (Bilingual)	18" x 4"	Red/White	Plastic
108770SF88ZD	PSP315	3D Fire Extinguisher	18" x 4"	Red/White	Plastic
108770SF88YQ	PSP330	3D Fire Extinguisher	12" x 4"	Red/White	Plastic
108770AO88ZX	PSP325	3D Fire Extinguisher	24" x 4"	Red/White	Plastic
108773AY88ZD	PSP426	90D Fire Extinguisher	18" x 4"	Red/White	Plastic
108773AY88YQ	PSP403	90D Fire Extinguisher	12" x 4"	Red/White	Plastic
108775AY881B	PSP113	3D Fire Extinguisher	6" x 5"	Red/White	Plastic
108775AY881H	PSP707	90D Fire Extinguisher	8" x 8"	Red/White	Plastic
108777AY881B	PSP618	3D Fire Extinguisher	6" x 5"	Red/White	Plastic
108777AY881H	PSP729	90D Fire Extinguisher	8" x 8"	Red/White	Plastic
108777AO881B	PSP348	3D Fire Extinguisher	6" x 5"	Red/White	Lumi-glow
108777AO881H	PSP459	90D Fire Extinguisher	8" x 8"	Red/White	Lumi-glow

Continued on Next Page

Workplace Safety Signage (continued)

C&M PART #	MFG PART #	DESCRIPTION	SIZE (H x W)	COLOR	MATERIAL
FIRST-AID					
108871AYSC1D	MFSD506VS	First Aid Kit	7" x 10"	Red/White	Vinyl
108871AY881D	MFSD506VP	First Aid Kit	7" x 10"	Red/White	Plastic
108873BG88YF	MGSH904VP	Safety First	10" x 14"	White/Black/Green	Plastic
108874BG88YF	MFSD960VP	First Aid Station	10" x 14"	White/Black/Green	Plastic
108875BG881B	PSP605	3D First Aid	6" x 5"	White/Black/Green	Plastic
FOLD-UPS					
108555AQ88ZQ	PFR229	Authorized Personnel Only	20" x 12"	White/Black/Red	Plastic
HOUSE KEEPING & HYGIENE					
108636AISC1D	MRST811VS	Employees Wash Hands	7" x 10"	White/Black/Blue	Vinyl
108636AI881D	MRST811VP	Employees Wash Hands	7" x 10"	White/Black/Blue	Plastic
108636AISCYF	MRST805VS	Employees Wash Hands	10" x 14"	White/Black/Blue	Vinyl
108636AI88YF	MRST805VP	Employees Wash Hands	10" x 14"	White/Black/Blue	Plastic
108635AI881D	MHSK845VP	Keep This Area Clean	7" x 10"	White/Black/Blue	Plastic
108647BG88YF	MHSK950VP	Keep This Plant Safe and Clean	10" x 14"	White/Black/Green	Plastic
108643AI88YT	SBMGNF803VP	No Eating/Drinking in This Area	14" x 10"	White/Black/Blue	Plastic
108640AISC1D	MHSK801VS	No Food or Drink in This Area	7" x 10"	White/Black/Blue	Vinyl
108640AI881D	MHSK801VP	No Food or Drink in This Area	7" x 10"	White/Black/Blue	Plastic
108640AI091D	MHSK801VA	No Food or Drink in This Area	7" x 10"	White/Black/Blue	Aluminum
108644AISC1D	MRST902VS	Please Wash Your Hands	7" x 10"	White/Black/Blue	Vinyl
108644AI881D	MRST902VP	Please Wash Your Hands	7" x 10"	White/Black/Blue	Plastic
108644AI88YF	MRST904VP	Please Wash Your Hands	10" x 14"	White/Black/Blue	Plastic
108620BJ881D	MSTF640VP	Slippery When Wet	7" x 10"	Yellow/Black	Plastic
108620BJ88YF	MSTF642VS	Slippery When Wet	10" x 14"	Yellow/Black	Vinyl
108620BJ88YF	MSTF642VP	Slippery When Wet	10" x 14"	Yellow/Black	Plastic
108632BJ88YT	SBMSTF642VP	Slippery When Wet (Bilingual)	14" x 10"	Yellow/Black	Plastic
108623BJSC1D	MSTF646VS	Step Down	7" x 10"	Yellow/Black	Vinyl
108623BJ881D	MSTF646VP	Step Down	7" x 10"	Yellow/Black	Plastic
108623BJ091D	MSTF646VA	Step Down	7" x 10"	Yellow/Black	Aluminum
108634AI88YT	SBMRST813VP	Wash Hands (Bilingual)	14" x 10"	White/Black/Blue	Plastic
108626BJSC1D	MSTF645VS	Watch Your Step	7" x 10"	Yellow/Black	Vinyl
108626BJ881D	MSTF645VP	Watch Your Step	7" x 10"	Yellow/Black	Plastic
108626BJ091D	MSTF645VA	Watch Your Step	7" x 10"	Yellow/Black	Aluminum
108626BJSCYF	MSTF661VS	Watch Your Step	10" x 14"	Yellow/Black	Vinyl
108626BJ88YF	MSTF661VP	Watch Your Step	10" x 14"	Yellow/Black	Plastic
108626BJ09YF	MSTF661VA	Watch Your Step	10" x 14"	Yellow/Black	Aluminum
108633BJ88YT	SBMSTF661VP	Watch Your Step (Bilingual)	14" x 10"	Yellow/Black	Plastic

C&M PART #	MFG PART #	DESCRIPTION	SIZE (H x W)	COLOR	MATERIAL
FLOOR					
108832BJSCYF	MFS245	Safety Glasses Required	17" Dia	Yellow/Black	Textured
108833BJSCYF	MFS246	Hearing Protection Required	17" Dia	Yellow/Black	Textured
108834BJSCYF	MFS250	PPE Required	17" Dia	Yellow/Black	Textured
108835BJSCYF	MFS252	Safety Shoes Required	17" Dia	Yellow/Black	Textured

Floor



First-Aid

Fold-Ups



House Keeping & Hygiene



Continued on Next Page

Workplace Safety Signage (continued)



C&M PART #	MFG PART #	DESCRIPTION	SIZE (H x W)	COLOR	MATERIAL
MUSTER POINT					
108754AL09ZB	FRR910RA	Muster Point	18" x 24"	Green/White	Aluminum
108755AL09ZB	FRR928RA	Emergency Assembly Point	18" x 24"	Green/White	Aluminum
108755AL09ZV	FRR929RA	Emergency Assembly Point	24" x 30"	Green/White	Aluminum
PARKING					
108488AM09YW	FRP246RA	Motorcycle Parking Only	18" x 12"	White/Black	Aluminum
108482BI09YW	FRP116RA	No Parking (Graphic)	18" x 12"	White/Red/Black	Aluminum
108483SF09YW	FRP127RA	No Parking Fire Lane	18" x 12"	White/Red	Aluminum
108485AG09YW	FRA234RA	Parking Only (Graphic)	18" x 12"	Blue/White	Aluminum
108486SE09YW	FRP206RA	Reserved Parking	18" x 12"	White/Green	Aluminum
108484SE09YW	FRA216RA	Reserved Parking (Graphic)	18" x 12"	White/Green/Blue	Aluminum
108487SE09YW	FRP218RA	Visitor Parking	18" x 12"	White/Green	Aluminum

Muster Point



Parking



PPE



108825BISCID

108829AISCID

C&M PART #	MFG PART #	DESCRIPTION	SIZE (H x W)	COLOR	MATERIAL
PPE					
108826BJSCYF	MPPA603VS	Ear Protection Must be Worn	7" x 10"	Yellow/Black	Vinyl
108827BJSCID	MPPA605VS	Ear Protection Must be Worn	10" x 14"	Yellow/Black	Vinyl
108821BI88ID	MFPR104VP	Fall Protection Required	7" x 10"	White/Black/Red	Plastic
108821BI88YF	MFPR105VP	Fall Protection Required	10" x 14"	White/Black/Red	Plastic
108823BISCID	MPPA004VS	Hard Hat Area	7" x 10"	White/Black/Red	Vinyl
108823BI88YF	MPPA005VP	Hard Hat Area	10" x 14"	White/Black/Red	Plastic
108828AI88YF	MPPA808VP	Hearing Protection Area	10" x 14"	White/Black/Blue	Plastic
108820BI88YF	MPPA036VP	PPE Beyond This Point	10" x 14"	White/Black/Red	Plastic
108825BISCID	MPPA001VS	Safety Glasses Required	7" x 10"	White/Black/Red	Vinyl
108829AISCID	MPPE854VS	Safety Glasses Required	7" x 10"	White/Black/Blue	Vinyl
108829AI88ID	MPPE854VP	Safety Glasses Required	7" x 10"	White/Black/Blue	Plastic
108829AI88YF	MPPA801VP	Safety Glasses Required	10" x 14"	White/Black/Blue	Plastic
POTABLE & NON-POTABLE WATER					
110279AISCID	MCAW808VS	Non-Potable Water	7" x 10"	White/Black/Blue	Vinyl
110279AISCYF	MCAW800VS	Non-Potable Water	10" x 14"	White/Black/Blue	Vinyl
110279AI88ID	MCAW808VP	Non-Potable Water	7" x 10"	White/Black/Blue	Plastic
110279AI88YF	MCAW800VP	Non-Potable Water	10" x 14"	White/Black/Blue	Plastic
110276AISCYT	SBMCAW805VS	Non-Potable Water (Bilingual)	14" x 10"	White/Black/Blue	Vinyl
110276AI88YT	SBMCAW805VP	Non-Potable Water (Bilingual)	14" x 10"	White/Black/Blue	Plastic
110276AI09YT	SBMCAW805VA	Non-Potable Water (Bilingual)	14" x 10"	White/Black/Blue	Aluminum
110272BJSCID	MCHL633VS	Do Not Drink	7" x 10"	Yellow/Black	Vinyl
110272BJSCYF	MCHL674VS	Do Not Drink	10" x 14"	Yellow/Black	Vinyl
110272BJ88ID	MCHL633VP	Do Not Drink	7" x 10"	Yellow/Black	Plastic
110272BJ88YF	MCHL674VP	Do Not Drink	10" x 14"	Yellow/Black	Plastic

Potable & Non-Potable Water



Continued on Next Page

Workplace Safety Signage (continued)

C&M PART #	MFG PART #	DESCRIPTION	SIZE (H x W)	COLOR	MATERIAL
POTABLE & NON-POTABLE WATER (CONTINUED)					
110270BISCYF	MCAW017VS	Do Not Use for Drinking	10" x 14"	White/Black/Red	Vinyl
110270BI88YF	MCAW017VP	Do Not Use for Drinking	10" x 14"	White/Black/Red	Plastic
110283AISC1D	MCAW806VS	Not for Drinking	7" x 10"	White/Black/Blue	Vinyl
110283AISCYF	MCAW805VS	Not for Drinking	10" x 14"	White/Black/Blue	Vinyl
110283AI881D	MCAW806VP	Not for Drinking	7" x 10"	White/Black/Blue	Plastic
110283AI88YF	MCAW805VP	Not for Drinking	10" x 14"	White/Black/Blue	Plastic
110268AISCYF	MCAW804VS	Water Safe to Drink	10" x 14"	White/Black/Blue	Vinyl
110268AI88YF	MCAW804VP	Water Safe to Drink	10" x 14"	White/Black/Blue	Plastic
RESTRICTED AREA					
108530BI88YF	MADC520VP	Authorized Employees Only	10" x 14"	White/Black/Red	Plastic
108496BI881D	MADM130VP	Authorized Personnel Only	7" x 10"	White/Black/Red	Plastic
108496BI88YF	MADM006VP	Authorized Personnel Only	10" x 14"	White/Black/Red	Plastic
108516AISC1D	MADC800VS	Authorized Personnel Only	7" x 10"	White/Black/Blue	Vinyl
108516AI881D	MADC800VP	Authorized Personnel Only	7" x 10"	White/Black/Blue	Plastic
108516AI88YF	MADC801VP	Authorized Personnel Only	10" x 14"	White/Black/Blue	Plastic
108533SF88YF	MADM499VP	Authorized Personnel Only	10" x 14"	White/Red	Plastic
108501BI881D	MADM138VP	Do Not Enter	7" x 10"	White/Black/Red	Plastic
108501BISC1D	MADM138VS	Do Not Enter	7" x 10"	White/Black/Red	Vinyl
108501BI88YF	MADM139VP	Do Not Enter	10" x 14"	White/Black/Red	Plastic
108515BJ88YF	MADC600VP	Do Not Enter	10" x 14"	Yellow/Black	Plastic
108509BI88YT	SBMADM139VP	Do Not Enter (Bilingual)	14" x 10"	White/Black/Red	Plastic
108509BI09YT	SBMADM139VA	Do Not Enter (Bilingual)	14" x 10"	White/Black/Red	Aluminum
108504BI88YF	MADM064VP	Keep Out	10" x 14"	White/Black/Red	Plastic
108504BI09YF	MADM064VA	Keep Out	10" x 14"	White/Black/Red	Aluminum
108498BISC1D	MADM024VS	Keep Out Authorized Personnel	7" x 10"	White/Black/Red	Vinyl
108498BI88YF	MADM007VP	Keep Out Authorized Personnel	10" x 14"	White/Black/Red	Plastic
108506BI881D	MADM292VP	No Trespassing	7" x 10"	White/Black/Red	Plastic
108506BI88YF	MADM076VP	No Trespassing	10" x 14"	White/Black/Red	Plastic
108506BI09YF	MADM076VA	No Trespassing	10" x 14"	White/Black/Red	Aluminum

C&M PART #	MFG PART #	DESCRIPTION	SIZE (H x W)	COLOR	MATERIAL
RESTRICTED AREA (CONTINUED)					
108512ASSCYF	MADM304VS	No Trespassing	10" x 14"	Orange/Black	Vinyl
108512AS88YF	MADM304VP	No Trespassing	10" x 14"	Orange/Black	Plastic
108512AS09YF	MADM304VA	No Trespassing	10" x 14"	Orange/Black	Aluminum
108523AI881D	MATR802VP	No Trespassing	7" x 10"	White/Black/Blue	Plastic
108523AI091D	MATR802VA	No Trespassing	7" x 10"	White/Black/Blue	Aluminum
108523AI88YF	MATR806VP	No Trespassing	10" x 14"	White/Black/Blue	Plastic
108523AI09YF	MATR806VA	No Trespassing	10" x 14"	White/Black/Blue	Aluminum
108527BI881D	MATR901VP	No Trespassing	7" x 10"	White/Black/Red	Plastic

Potable & Non-Potable Water



Restricted Area



108530BI88YF

108496BI881D

108516AISC1D



108533SF88YF

108501AQ881D

108515BJ88YF



108506BI88YF

108512ASSCYF

108523AI091D

Continued on Next Page

Workplace Safety Signage (continued)

C&M PART #	MFG PART #	DESCRIPTION	SIZE (H x W)	COLOR	MATERIAL
RESTRICTED AREA (CONTINUED)					
108527BISCYF	MATR900VS	No Trespassing	10" x 14"	White/Black/Red	Vinyl
108527BI09YF	MATR900VA	No Trespassing	10" x 14"	White/Black/Red	Aluminum
108511AQ88YT	SBMADM076VP	No Trespassing (Bilingual)	14" x 10"	White/Black/Red	Plastic
108531BI88YT	SBMATR510VP	Private Property (Bilingual)	14" x 10"	White/Black/Red	Plastic
108531BI09YT	SBMATR510VA	Private Property (Bilingual)	14" x 10"	White/Black/Red	Aluminum
108534SF88YF	MADM578VP	Private Property No Trespass	10" x 14"	White/Red	Plastic
108500BI88YF	MADM149VP	Restricted Area	10" x 14"	White/Black/Red	Plastic
108519AISCID	MADC807VS	Restricted Area	7" x 10"	White/Black/Blue	Vinyl
108519AI88ID	MADC807VP	Restricted Area	7" x 10"	White/Black/Blue	Plastic
108519AISCYF	MADC808VS	Restricted Area	10" x 14"	White/Black/Blue	Vinyl
108519AI88YF	MADC808VP	Restricted Area	10" x 14"	White/Black/Blue	Plastic

Restricted Area



108500BI88YF

108519AISCYF

Smoking Control



Stencil



C&M PART #	MFG PART #	DESCRIPTION	SIZE (H x W)	COLOR	MATERIAL
SMOKING CONTROL					
109013BISCID	MSMK132VS	Danger No Smoking	7" x 10"	White/Black/Red	Vinyl
109013BI88ID	MSMK132VP	Danger No Smoking	7" x 10"	White/Black/Red	Plastic
109013BISCYF	MSMK133VS	Danger No Smoking	10" x 14"	White/Black/Red	Vinyl
109013BI88YF	MSMK133VP	Danger No Smoking	10" x 14"	White/Black/Red	Plastic
108656AY09ID	MSMK404VA	Designated Smoking Area	7" x 10"	Red/White	Aluminum
108656AY09YF	MSMK403VA	Designated Smoking Area	10" x 14"	Red/White	Aluminum
108648AYSCID	MSMK423VS	No Smoking	7" x 10"	Red/White	Vinyl
108648AY88ID	MSMK423VP	No Smoking	7" x 10"	Red/White	Plastic
108648AYSCTF	MSMK570VS	No Smoking	10" x 14"	Red/White	Vinyl
108648AY88YF	MSMK570VP	No Smoking	10" x 14"	Red/White	Plastic
108652BISCYG	MSMK407VS	No Smoking (Graphic)	10" x 7"	White/Black/Red	Vinyl
108652BI88YG	MSMK407VP	No Smoking (Graphic)	10" x 7"	White/Black/Red	Plastic
108652BI09YG	MSMK407VA	No Smoking (Graphic)	10" x 7"	White/Black/Red	Aluminum
108652BI88YT	MSMK919VP	No Smoking (Graphic)	14" x 10"	White/Black/Red	Plastic
SPEED LIMIT					
108477BJ09ZU	FRW427RA	Pedestrian Crossing (Graphic)	24" x 24"	Yellow/Black	Aluminum
108477BJ09WK	FRW527RA	Pedestrian Crossing (Graphic)	30" x 30"	Yellow/Black	Aluminum
108473BJ09YW	FRW477RA	Slow Blind Corner	18" x 12"	Yellow/Black	Aluminum
108473BJ09ZT	FRW478RA	Slow Blind Corner	24" x 18"	Yellow/Black	Aluminum
108475BJ09YW	FRW479RA	Slow Speed Bump	18" x 12"	Yellow/Black	Aluminum
108475BJ09ZT	FRW480RA	Slow Speed Bump	24" x 18"	Yellow/Black	Aluminum
108479AM09YW	FRR2185RA	Speed Limit 5	18" x 12"	White/Black	Aluminum
108479AM09ZT	FRR2245RA	Speed Limit 5	24" x 18"	White/Black	Aluminum
108479AM09WJ	FRR3245RA	Speed Limit 5	30" x 24"	White/Black	Aluminum
STENCIL					
10861767SIID	CST716	Confined Space Stencil	7" x 10"	Grey	Mylar

Speed Limit



Continued on Next Page

Workplace Safety Signage (continued)

C&M PART #	MFG PART #	DESCRIPTION	SIZE (H x W)	COLOR	MATERIAL
SURVEILLANCE					
108542AN88YF	MASE823VP	Monitored by Video Camera	10" x 14"	White/Black/Blue	Plastic
108543ANSCID	MASE806VS	Under 24 Hour Surveillance	7" x 10"	White/Black/Blue	Vinyl
108543AN88ID	MASE806VP	Under 24 Hour Surveillance	7" x 10"	White/Black/Blue	Plastic
108543AN09ID	MASE806VA	Under 24 Hour Surveillance	7" x 10"	White/Black/Blue	Aluminum
108543ANSCYF	MASE807VS	Under 24 Hour Surveillance	10" x 14"	White/Black/Blue	Vinyl
108543AN88YF	MASE807VP	Under 24 Hour Surveillance	10" x 14"	White/Black/Blue	Plastic
108543AN09YF	MASE807VA	Under 24 Hour Surveillance	10" x 14"	White/Black/Blue	Aluminum
108549AN09ID	MASE816VA	Video Surveillance in Use	7" x 10"	White/Black/Blue	Aluminum
108549AN88YF	MASE801VP	Video Surveillance (Graphic)	10" x 14"	White/Black/Blue	Plastic
TRAFFIC					
108466AY09ZU	MRS124RA	Do Not Enter	24" x 24"	Red/White	Aluminum
108466AY09WK	MRS130RA	Do Not Enter	30" x 30"	Red/White	Aluminum
108471AM09YW	FRR229RA	Exit Only Do Not Enter	18" x 12"	White/Black	Aluminum
108471AM09ZT	FRR230RA	Exit Only Do Not Enter	24" x 18"	White/Black	Aluminum
108470AM09ZT	FRR126RA	No Thru Traffic	24" x 18"	White/Black	Aluminum
108468AM09ZB	FRR043RA	No Trucks	18" x 24"	White/Black	Aluminum
108459AY09ZA	FRR012	Stop	18" x 18"	Red/White	Aluminum
108459AY09ZU	MRT124	Stop	24" x 24"	Red/White	Aluminum
108469AM09ZB	FRR045RA	Truck Entrance	18" x 24"	White/Black	Aluminum
108464AY09ZB	FRR022RA	Wrong Way	18" x 24"	Red/White	Aluminum
108464AY09ZC	FRR026RA	Wrong Way	18" x 30"	Red/White	Aluminum
108461AY09ZU	FRR424RA	Yield	24" x 24"	Red/White	Aluminum
108461AY09WK	FRR425RA	Yield	30" x 30"	Red/White	Aluminum
108461AY09WN	FRR426RA	Yield	36" x 36"	Red/White	Aluminum
VISITORS & EMPLOYEES					
108535AISCID	MADC803VS	Employees Only	7" x 10"	White/Black/Blue	Vinyl
108535AI88ID	MADC803VP	Employees Only	7" x 10"	White/Black/Blue	Plastic
108535AISCYF	MADC804VS	Employees Only	10" x 14"	White/Black/Blue	Vinyl
108535AI88YF	MADC804VP	Employees Only	10" x 14"	White/Black/Blue	Plastic
108535AI09YF	MADC804VA	Employees Only	10" x 14"	White/Black/Blue	Aluminum
108540AI88YF	MADM894VP	Employees Only Beyond Point	10" x 14"	White/Black/Blue	Plastic
108541AI88YF	MADM808VP	No Admittance Employee Only	10" x 14"	White/Black/Blue	Plastic
VOLTAGE MARKERS					
108984AESCYE	LELC439	480 Volts	1/2" x 2-1/4"	Orange/Black	Vinyl
108984AESCYM	LELC440	480 Volts	1-1/8" x 4-1/2"	Orange/Black	Vinyl
108984AESCSZS	LELC441	480 Volts	2-1/4" x 9"	Orange/Black	Vinyl

Surveillance



Traffic



Visitors & Employees



Voltage Markers



PPE Dispensers



Use these dispensers to easily dispense PPE for visitors and employees. These sturdy acrylic dispensers keep PPE items organized and are labeled to the specific dispensed items. Place on benchtop or wall mount (except the compact dispensers) to keep benchtop clear.

C&M PART #	MFG PART #	DESCRIPTION	MATERIAL
108836390ASE	AEP-4	Ear Plugs Dispenser, Small	Acrylic
108836390BSE	AEP-D	Ear Plugs Dispenser, Large	Acrylic
108842390ESE	AEP-3	Ear Plugs Tray Dispenser	Acrylic
108839390CSE	AGBS	Nitrile Gloves Dispenser, Single Box	Acrylic
108839390DSE	AGBD	Nitrile Gloves Dispenser, Double Box	Acrylic
108839390GSE	AGBT	Nitrile Gloves Dispenser, Triple Box	Acrylic
10883839SEYN	ACD	Bouffant Caps, Beard Covers, Shoe Covers Dispenser	Acrylic
108843390FSE	ASG-D	Visitor Safety Glasses Dispenser	Acrylic
108843390HSE	ASG-3	Safety Glasses Dispenser, Double Compartment	Acrylic
108843390ISE	ABM	Miscellaneous Covered Dispenser	Acrylic
10884668	ADT	Compact Dispenser, No Cover	Acrylic
10884669	ADTC	Compact Covered Dispenser	Acrylic

Cylinder Tags



Quickly and easily identify when a cylinder is safe to use with these Cylinder Tags. Green tags indicates that a cylinder is ready/OK for use; red tag indicates that a cylinder is empty or not to use. All tags measure 5-3/4"H x 3-1/4"W. Plastic tags come with a grommet around the hole for durability.

C&M PART #	MFG PART #	DESCRIPTION	MATERIAL	QUANTITY
109026AYSIWZ	MGT202CTP	Empty Cylinder Do Not Use	PF-Cardstock	25/Pack
109026AYSKWZ	MGT202PTP	Empty Cylinder Do Not Use	Plastic	25/Pack
109024ALSIWZ	MGT203CTP	Full Cylinder Ready for Use	PF-Cardstock	25/Pack
109024ALSKWZ	MGT203PTP	Full Cylinder Ready for Use	Plastic	25/Pack
109022AYSIWZ	MGT206CTP	Cylinder Empty/ In Use/Full	PF-Cardstock	25/Pack
109022AYSKWZ	MGT206PTP	Cylinder Empty/ In Use/Full	Plastic	25/Pack
108791ALSIWZ	MGT217CTP	OK to Use	PF-Cardstock	25/Pack
108791ALSKWZ	MGT217PTP	OK to Use	Plastic	25/Pack
108793AYSIWZ	MGT219CTP	Do Not Use	PF-Cardstock	25/Pack
108793AYSKWZ	MGT219PTP	Do Not Use	Plastic	25/Pack



Box of Tags

Box of Tags is a convenient way to keep safety tags available wherever you may need them. Each tear-resistant and waterproof tag measures 5-3/4"H x 3-1/4"W and feature a 3/8" plain hole. Easily write on the matte surface with a pen or permanent marker. Tags come in a convenient resealable box for easy storage.



C&M PART #	MFG PART #	DESCRIPTION	MATERIAL	QUANTITY
108932AQSIWZ	TXB301	Danger Do Not Operate	PF-Cardstock	50/Box
108933AQSIWZ	TXB305	Danger (Blank)	PF-Cardstock	50/Box
108934AQSIWZ	TXB307	Danger Barricade	PF-Cardstock	50/Box



Evacuation Door Hanger

Hang it on a doorknob to inform personnel that a room is evacuated, and no personnel confide within that room. Orange doorknob tag easily stands out when time is of the essence.



C&M PART #	MFG PART #	DESCRIPTION	MATERIAL	QUANTITY
108757AS881K	TAD838	Evacuated, 9"H x 4"W	Plastic	10/pack

Tags-By-The-Roll

Use these Tags-By-The-Roll tags to identify temporary hazards. Each tag measures 6-1/4"H x 3"W and is made of scuff- and water-resistant poly cardstock. Easily write on the matte surface. Tags are connected, perforated and rolled in an octagonal-shaped dispenser to help keep tags organized, contained, protected and ready-to-use. Place the box any flat surface or mount on a 1/2" or less rod. Tags By-The-Roll are available in 100 or 250 per roll and a wide-variety of messages that include lockout/tagout, inspection, status record and general safety tags.

C&M PART #	MFG PART #	DESCRIPTION	MATERIAL	QUANTITY
108916ACSIIC	TAR110	Do Not Operate	PF-Cardstock	100/RL
108917ACSIIC	TAR121	Do Not Operate	PF-Cardstock	250/RL
108918ACSIIC	TAR106	Do Not Operate	PF-Cardstock	100/RL
108919ACSIIC	TAR142	Do Not Operate	PF-Cardstock	250/RL
108920ACSIIC	TAR118	Out of Service	PF-Cardstock	100/RL
108921ACSIIC	TAR148	Out of Service	PF-Cardstock	250/RL
108922ACSIIC	TAR104	Do Not Enter	PF-Cardstock	100/RL
108923ACSIIC	TAR140	Do Not Enter	PF-Cardstock	250/RL
108924ACSIIC	TAR412	Danger (Blank)	PF-Cardstock	100/RL
108925ACSIIC	TAR423	Danger (Blank)	PF-Cardstock	250/RL
108926ACSIIC	TAR136	Barricade	PF-Cardstock	100/RL
108927ACSIIC	TAR160	Barricade	PF-Cardstock	250/RL
109028AGSIIC	TAR114	Lock-Out Tag-Out	PF-Cardstock	100/RL
109029AGSIIC	TAR125	Lock-Out Tag-Out	PF-Cardstock	250/RL
109030AGSIIC	TAR404	Do not Operate Lock	PF-Cardstock	100/RL
109031AGSIIC	TAR472	Do not Operate Lock	PF-Cardstock	250/RL
109032AGSIIC	TAR402	Do not Operate Equip.	PF-Cardstock	100/RL
109033AGSIIC	TAR470	Do not Operate Equip.	PF-Cardstock	250/RL
109034AGSIIC	TAR410	Equipment Locked Out	PF-Cardstock	100/RL
109035AGSIIC	TAR478	Equipment Locked Out	PF-Cardstock	250/RL
109036AGSIIC	TAR416	Danger Locked Out	PF-Cardstock	100/RL
109037AGSIIC	TAR426	Danger Locked Out	PF-Cardstock	250/RL



108916ACSIIC



108918ACSIIC



108920ACSIIC



108922ACSIIC



108924ACSIIC



108926ACSIIC



109028AGSIIC



109030AGSIIC



109032AGSIIC



109035AGSIIC



109036AGSIIC



Fire Extinguisher Tags

Step-by-step instructions on how to use the fire extinguisher helps prevent confusion. Cardstock material is ideal for indoor and short-term outdoor use; durable plastic material is great for both indoor and outdoor use. Easily write on the tags with a pen or permanent marker. Plastic tags feature a grommet around the hole for durability.



C&M PART #	MFG PART #	DESCRIPTION	MATERIAL	QUANTITY
108788BISIWZ	TRS218CTP	Fire Extinguisher Instructions	PF-Cardstock	25/pack
108788BISKWZ	TRS218PTP	Fire Extinguisher Instructions	Plastic	25/pack

First Aid Labels



Place these tags to indicate where to locate a first aid kit in an emergency. Labels are made of durable vinyl adhesive and measure 3-1/2"H x 5"W.

C&M PART #	MFG PART #	DESCRIPTION	MATERIAL	QUANTITY
108877BGSCWI	LFSD509VSP	First Aid Kit Inside	Vinyl	5/pack
108876ALSCWI	LVHR560VSP	First Aid Kit Located Inside	Vinyl	5/pack



Equipment Status Tags



10882BISKWZ

10884BISKWZ

108900BJSKWZ



10888AZSKWZ

108890BISKWZ

108896BISKWZ



108892BISKWZ

108886BISKWZ

108894BISKWZ



108902BJSKWZ

108906AYAKWZ

108898BISKWZ



108908BISKWZ

108910ASSKWZ

108904BJSKWZ



108912BJSKWZ

108914SCSKWZ



Safety tags are necessary for many workplaces to comply with OSHA regulations. They are useful in identifying specific dangers or hazards, such as equipment that is malfunctioning or in need of repair or limiting entrance to hazardous areas. All tags measure 5-3/4"H x 3-1/4"W. Plastic tags feature a grommet around the hole for durability.

C&M PART #	MFG PART #	DESCRIPTION	MATERIAL	QUANTITY
108882BISIWZ	MDT164CTP	Danger Do Not Enter	PF-Cardstock	25/pack
108882BISKWZ	MDT164PTP	Danger Do Not Enter	Plastic	25/pack
108884BISIWZ	MDT112CTP	Danger Do Not Operate	PF-Cardstock	25/pack
108884BISKWZ	MDT112PTP	Danger Do Not Operate	Plastic	25/pack
108900BJSIWZ	MDT610CTP	Caution Do Not Operate	PF-Cardstock	25/pack
108900BJSKWZ	MDT610PTP	Caution Do Not Operate	Plastic	25/pack
108888AZSIWZ	MDGT211CTP	Danger Do Not Operate	PF-Cardstock	25/pack
108888AZSKWZ	MDGT211PTP	Danger Do Not Operate	Plastic	25/pack
108890BISIWZ	MDT106CTP	Danger Do Not Use	PF-Cardstock	25/pack
108890BISKWZ	MDT106PTP	Danger Do Not Use	Plastic	25/pack
108896BISIWZ	MDT158CTP	Danger Out of Service	PF-Cardstock	25/pack
108896BISKWZ	MDT158PTP	Danger Out of Service	Plastic	25/pack
108892BISIWZ	MDT184CTP	Danger Do Not Use (Reason Tagged)	PF-Cardstock	25/pack
108892BISKWZ	MDT184PTP	Danger Do Not Use (Reason Tagged)	Plastic	25/pack
108886BISIWZ	TMS109CTP	Danger Do Not Operate (Bilingual)	PF-Cardstock	25/pack
108886BISKWZ	TMS109PTP	Danger Do Not Operate (Bilingual)	Plastic	25/pack
108894BISIWZ	TSP164CTP	Danger Unsafe Do Not Use (Bilingual)	PF-Cardstock	25/pack
108894BISKWZ	TSP164PTP	Danger Unsafe Do Not Use (Bilingual)	Plastic	25/pack
108902BJSIWZ	TSP626CTP	Caution Do Not Operate (Bilingual)	PF-Cardstock	25/pack
108902ARSKWZ	TSP626PTP	Caution Do Not Operate (Bilingual)	Plastic	25/pack
108906AYSIWZ	TSP505CTP	Out of Service (Bilingual)	PF-Cardstock	25/pack
108906AYAKWZ	TSP505PTP	Out of Service (Bilingual)	Plastic	25/pack
108898BISIWZ	MDT161CTP	Danger (Blank)	PF-Cardstock	25/pack
108898BISKWZ	MDT161PTP	Danger (Blank)	Plastic	25/pack
108908BISIWZ	MDT260CTP	Danger (Blank)	PF-Cardstock	25/pack
108908BISKWZ	MDT260PTP	Danger (Blank)	Plastic	25/pack
108910ASSIWZ	MWGT205CTP	Warning (Blank)	PF-Cardstock	25/pack
108910ASSKWZ	MWGT205PTP	Warning (Blank)	Plastic	25/pack
108904BJSIWZ	MDT612CTP	Caution (Blank)	PF-Cardstock	25/pack
108904BJSKWZ	MDT612PTP	Caution (Blank)	Plastic	25/pack
108912BJSIWZ	MGT200CTP	Caution (Blank)	PF-Cardstock	25/pack
108912BJSKWZ	MGT200PTP	Caution (Blank)	Plastic	25/pack
108914SCSIWZ	MNT101CTP	Notice (Blank)	PF-Cardstock	25/pack
108914SCSKWZ	MNT101PTP	Notice (Blank)	Plastic	25/pack

Inspection and Status Record Tags

Inspection and Status Tags are typically attached to equipment or machinery to indicate when the last inspection was performed, the date of the next scheduled inspection and any specific instructions or remarks related to the inspection. They often include fields for recording the inspector's name, date, and findings. They are also used to indicate the status or condition of an item or process. All tags measure 5-3/4"H x 3-1/4"W. Plastic tags feature a grommet around the hole for durability.

C&M PART #	MFG PART #	DESCRIPTION	MATERIAL	QUANTITY
108795BISIWZ	TRS243CTP	Out of Service Status Record	PF-Cardstock	25/pack
108795BISKWZ	TRS243PTP	Out of Service Status Record	Plastic	25/pack
108797BJSIWZ	TCS361CTP	Hot Work Permit	PF-Cardstock	25/pack
108797BJSKWZ	TCS361PTP	Hot Work Permit	Plastic	25/pack
108799BJSIWZ	TRS309CTP	Maintenance Record	PF-Cardstock	25/pack
108799BJSKWZ	TRS309PTP	Maintenance Record	Plastic	25/pack
108801BGSIWZ	MGT207CTP	Shower/Eyewash Test Record	PF-Cardstock	25/pack
108801BGSKWZ	MGT207PTP	Shower/Eyewash Test Record	Plastic	25/pack
108803SESIWZ	TRS315CTP	Safety Inspection	PF-Cardstock	25/pack
108803SESKWZ	TRS315PTP	Safety Inspection	Plastic	25/pack
10880568SIWZ	TRS307CTP	Inspection Record	PF-Cardstock	25/pack
10880568SKWZ	TRS307PTP	Inspection Record	Plastic	25/pack
108807BISIWZ	TRS345CTP	AED Inspection	PF-Cardstock	25/pack
108807BISKWZ	TRS345PTP	AED Inspection	Plastic	25/pack
108809BISIWZ	TRS340CTP	Ladder Inspection	PF-Cardstock	25/pack
108809BISKWZ	TRS340PTP	Ladder Inspection	Plastic	25/pack
108786AQSIWZ	MGT208CTP	Recharge & Inspection Record	PF-Cardstock	25/pack
108786AQSKWZ	MGT208PTP	Recharge & Inspection Record	Plastic	25/pack
108790C4090U	TRS220	Fire Extinguisher Inspection Record	Aluminum	5/pack



ACCUFORMNMC
JustIn Safety Group



Helpful Tip: Signs Suffix Legend

- VS = Adhesive Vinyl
- VP = Plastic
- VA = Aluminum
- RA = EGP Reflective Aluminum
- GF = Lumi-Glow™ Flex
- GP = Lumi-Glow™ Plastic

Loop 'n Lock™ Tie Tag

Loop 'n Lock Tie Tag is perfect for any place where tags need to always be secured. Tag can only be cut or pulled apart with excessive force. Self-locking plastic tie strap is permanently attached to the tag with an 8" long, ribbed tie strap that adjusts and locks for tight security with a rated 50-lb pull strength. Tag measures 5-3/4"H x 3-1/4"W.



ACCUFORMNMC
JustIn Safety Group

C&M PART #	MFG PART #	DESCRIPTION	MATERIAL	QUANTITY
108935AQSKWZ	TAK607	Danger Do Not Operate	Plastic	10/pack

Lockout Tagout Tags

Lockout Tagout (LOTO) Tags are an essential part of the lockout/tagout safety procedure which is designed to protect workers from hazardous energy sources during maintenance, repair or servicing of equipment. LOTO tags serve as a visual warning and communication tool to indicate that equipment or machinery is locked out and should not be operated. All tags measure 5-3/4"H x 3-1/4"W. Plastic tags feature a grommet around the hole for durability.



C&M PART #	MFG PART #	DESCRIPTION	MATERIAL	QUANTITY
109038BISIWZ	MLT400CTP	Do Not Operate	PF-Cardstock	25/pack
109038BISKWZ	MLT400PTP	Do Not Operate	Plastic	25/pack
109040BISIWZ	MLT405CTP	Do Not Operate Equipment Locked Out	PF-Cardstock	25/pack
109040BISKWZ	MLT405PTP	Do Not Operate Equipment Locked Out	Plastic	25/pack
109042BISIWZ	MLT401CTP	Do Not Operate, Maintenance Department	PF-Cardstock	25/pack
109042BISKWZ	MLT401PTP	Do Not Operate, Maintenance Department	Plastic	25/pack
109044BISIWZ	MLT403CTP	Do Not Start This, Locked Out	PF-Cardstock	25/pack
109044BISKWZ	MLT403PTP	Do Not Start This, Locked Out	Plastic	25/pack
109046BISIWZ	MLT410CTP	Equipment Locked Out	PF-Cardstock	25/pack
109046BISKWZ	MLT410PTP	Equipment Locked Out	Plastic	25/pack
109048BISIWZ	MLT407CTP	Locked Out Do Not Operate	PF-Cardstock	25/pack
109048BISKWZ	MLT407PTP	Locked Out Do Not Operate	Plastic	25/pack
109050BISIWZ	MLT418CTP	Locked Out Do Not Remove	PF-Cardstock	25/pack
109050BISKWZ	MLT418PTP	Locked Out Do Not Remove	Plastic	25/pack
109052BISIWZ	TSP101CTP	Do Not Operate (Bilingual)	PF-Cardstock	25/pack
109052BISKWZ	TSP101PTP	Do Not Operate (Bilingual)	Plastic	25/pack
109058BISIWZ	MLT603LCP	Equipment Locked Out	PF-Cardstock	25/pack
109059BISIWZ	MLT611LCP	Do Not Operate Locked Out	PF-Cardstock	25/pack

Loop 'n Strap™ Status Tags



As simple as the name! Simply loop strap around and insert back into strap to hang the tags—no need for wires, string or ties. Simple, durable design allows for space for an authorized personnel signature and date. Traditional OSHA-style signs, tags and labels are the most widely recognized design format in the industry. Flexible plastic has 5-1/4"H x 3-1/4"W body with 6"L x 1-3/8"W strap (4"L x 7/16" opening).

C&M PART #	MFG PART #	DESCRIPTION	MATERIAL	QUANTITY
108928BISKWZ	TAL350	Danger Do Not Operate	Plastic	25/pack
108929BISKWZ	TAL354	Danger Out of Service	Plastic	25/pack
108930BISKWZ	TAL321	Danger (Blank)	Plastic	25/pack
108931BJSKWZ	TAL325	Caution (Blank)	Plastic	25/pack

Tanks



TABLE OF CONTENTS

Dual Containment Tanks	416-417
Process Chemical Tanks	418
Chemical Feed Tanks	419
Chemical Solution Tanks	419

Peabody Gemini Dual Containment® Tanks



Use these double-walled Gemini Dual Containment Tanks to safely store chemicals and other products when a secondary containment tank system is required. All tanks meet or exceed secondary containment regulations set under EPA 49CFR. Tanks are durable, heavy-duty and are unaffected by the ultraviolet rays of the sun or other environmental conditions—perfect for indoor or outdoor use.

Pump mounting surface, female threaded connections and twist lid inspection port provide an easy way to dispense your chemicals. Integral recessed door molded directly into most Gemini models allows for inexpensive installation of optional dual wall bulkhead fitting for flooded suction and bottom fill applications.

FEATURES & BENEFITS

- Linear Polyethylene (LPE) tanks are ALS Group USA, Corp. NSF/ANSI/CAN 61 certified
- XLPE tanks 40 gallons and up are certified NSF/ANSI/CAN 61
- Unaffected by the ultra-violet rays of the sun or other environmental conditions
- Rated for a wide range of chemical applications

C&M PART #	MFG PART #	CAPACITY (GAL) INNER/ OUTER	MATERIAL	COLOR	DIMENSIONS
CYLINDRICAL TANKS					
107155S219AK	01-28907	15/25	LPE SD 1.5	Blue	19.5" Dia x 28.75"H
107155S22XAK	01-28906	15/25	LPE SD 1.5	Natural	19.5" Dia x 28.75"H
107155S219AL	01-29772	15/25	LPE HD 1.9	Blue	19.5" Dia x 28.75"H
107155S22XAL	01-29763	15/25	LPE HD 1.9	Natural	19.5" Dia x 28.75"H
107159S22XAM	01-30124	15/25	XLPE - SD 1.5	Natural	19.5" Dia x 28.75"H
107159S22XAN	01-30135	15/25	XLPE - HD 1.9	Natural	19.5" Dia x 28.75"H
107161V219AK	01-14871	20/28	LPE SD 1.5	Blue	22" Dia x 26.75"H
107161V22XAK	01-1073	20/28	LPE SD 1.5	Natural	22" Dia x 26.75"H
107161V219AL	01-29773	20/28	LPE HD 1.9	Blue	22" Dia x 26.75"H
107161V22XAL	01-29764	20/28	LPE HD 1.9	Natural	22" Dia x 26.75"H
107165V22XAM	01-30125	20/28	XLPE - SD 1.5	Natural	22" Dia x 26.75"H
107165V22XAN	01-30136	20/28	XLPE - HD 1.9	Natural	22" Dia x 26.75"H
107167AL19AK	01-29436	40/51	LPE SD 1.5	Blue	22" Dia x 42.5"H
107167AL2XAK	01-29437	40/51	LPE SD 1.5	Natural	22" Dia x 42.5"H

C&M PART #	MFG PART #	CAPACITY (GAL) INNER/ OUTER	MATERIAL	COLOR	DIMENSIONS
CYLINDRICAL TANKS (CONTINUED)					
107167AL19AL	01-29775	40/51	LPE HD 1.9	Blue	22" Dia x 42.5"H
107167AL2XAL	01-29766	40/51	LPE HD 1.9	Natural	22" Dia x 42.5"H
107167AL2XAM	01-30127	40/51	XLPE - SD 1.5	Natural	22" Dia x 42.5"H
107167AL2XAN	01-30138	40/51	XLPE - HD 1.9	Natural	22" Dia x 42.5"H
107173BW19AK	01-29920	65/92	LPE SD 1.5	Blue	27" Dia x 47"H
107173BW2XAK	01-29921	65/92	LPE SD 1.5	Natural	27" Dia x 47"H
107173BW19AL	01-29922	65/92	LPE HD 1.9	Blue	27" Dia x 47"H
107173BW2XAL	01-29923	65/92	LPE HD 1.9	Natural	27" Dia x 47"H
107173BW2XAM	01-30129	65/92	XLPE - SD 1.5	Natural	27" Dia x 47"H
107173BW2XAN	01-30140	65/92	XLPE - HD 1.9	Natural	27" Dia x 47"H
107179CW19AK	01-30294	90/116	LPE SD 1.5	Blue	34" Dia x 41.25"H
107179CW2XAK	01-30295	90/116	LPE SD 1.5	Natural	34" Dia x 41.25"H
107179CW19AL	01-30296	90/116	LPE HD 1.9	Blue	34" Dia x 41.25"H
107179CW2XAL	01-30297	90/116	LPE HD 1.9	Natural	34" Dia x 41.25"H
107179CW2XAM	01-30298	90/116	XLPE - SD 1.5	Natural	34" Dia x 41.25"H
107179CW2XAN	01-30299	90/116	XLPE - HD 1.9	Natural	34" Dia x 41.25"H
107185DS19AK	01-14870	120/142	LPE SD 1.5	Blue	33" Dia x 47"H
107185DS2XAK	01-1072	120/142	LPE SD 1.5	Natural	33" Dia x 47"H
107185DS19AL	01-29777	120/142	LPE HD 1.9	Blue	33" Dia x 47"H
107185DS2XAL	01-29768	120/142	LPE HD 1.9	Natural	33" Dia x 47"H
107185DS2XAM	01-30130	120/142	XLPE - SD 1.5	Natural	33" Dia x 47"H
107185DS2XAN	01-30141	120/142	XLPE - HD 1.9	Natural	33" Dia x 47"H
107191NM19AK	01-29877	160/224	LPE SD 1.5	Blue	34" Dia x 68"H
107191NM2XAK	01-29939	160/224	LPE SD 1.5	Natural	34" Dia x 68"H
107191NM19AL	01-29940	160/224	LPE HD 1.9	Blue	34" Dia x 68"H
107191NM2XAL	01-29941	160/224	LPE HD 1.9	Natural	34" Dia x 68"H
107191NM2XAM	01-30131	160/224	XLPE - SD 1.5	Natural	34" Dia x 68"H
107191NM2XAN	01-30142	160/224	XLPE - HD 1.9	Natural	34" Dia x 68"H
107197EN19AK	01-14872	220/278	LPE SD 1.5	Blue	48" Dia x 48"H
107197EN2XAK	01-1074	220/278	LPE SD 1.5	Natural	48" Dia x 48"H
107197EN19AL	01-29778	220/278	LPE HD 1.9	Blue	48" Dia x 48"H
107197EN2XAL	01-29769	220/278	LPE HD 1.9	Natural	48" Dia x 48"H
107197EN2XAM	01-30132	220/278	XLPE - SD 1.5	Natural	48" Dia x 48"H
107197EN2XAN	01-30143	220/278	XLPE - HD 1.9	Natural	48" Dia x 48"H
107203ES19AK	01-14873	320/385	LPE SD 1.5	Blue	48" Dia x 60.5"H
107203ES2XAK	01-1075	320/385	LPE SD 1.5	Natural	48" Dia x 60.5"H
107203ES19AL	01-29779	320/385	LPE HD 1.9	Blue	48" Dia x 60.5"H
107203ES2XAL	01-29770	320/385	LPE HD 1.9	Natural	48" Dia x 60.5"H
107203ES2XAM	01-30133	320/385	XLPE - SD 1.5	Natural	48" Dia x 60.5"H
107203ES2XAN	01-30144	320/385	XLPE - HD 1.9	Natural	48" Dia x 60.5"H
107209FD19AK	01-14876	500/650	LPE SD 1.5	Blue	61" Dia x 66.5"H
107209FD2XAK	01-14875	500/650	LPE SD 1.5	Natural	61" Dia x 66.5"H
107209FD19AL	01-29780	500/650	LPE HD 1.9	Blue	61" Dia x 66.5"H
107209FD2XAL	01-29771	500/650	LPE HD 1.9	Natural	61" Dia x 66.5"H
107209FD2XAM	01-30134	500/650	XLPE - SD 1.5	Natural	61" Dia x 66.5"H
107209FD2XAN	01-30145	500/650	XLPE - HD 1.9	Natural	61" Dia x 66.5"H

Continued on Next Page



Peabody Gemini Dual Containment® Tanks (continued)

C&M PART #	MFG PART #	CAPACITY (GAL) INNER/ OUTER	MATERIAL	COLOR	DIMENSIONS
CYLINDRICAL TANKS—FLAT TOP					
107215AL19AK	01-14874	40/50	LPE SD 1.5	Blue	23.5" Dia x 39.5"H
107215AL2XAK	01-1076	40/50	LPE SD 1.5	Natural	23.5" Dia x 39.5"H
107215AL19AL	01-29774	40/50	LPE HD 1.9	Blue	23.5" Dia x 39.5"H
107215AL2XAL	01-29765	40/50	LPE HD 1.9	Natural	23.5" Dia x 39.5"H
107215AL2XAM	01-30126	40/50	XLPE - SD 1.5	Natural	23.5" Dia x 39.5"H
107215AL2XAN	01-30137	40/50	XLPE - HD 1.9	Natural	23.5" Dia x 39.5"H
107221BT19AK	01-14877	62/74	LPE SD 1.5	Blue	25.5" Dia x 38"H
107221BT2XAK	01-1077	62/74	LPE SD 1.5	Natural	25.5" Dia x 38"H
107221BT19AL	01-29776	62/74	LPE HD 1.9	Blue	25.5" Dia x 38"H
107221BT2XAL	01-29767	62/74	LPE HD 1.9	Natural	25.5" Dia x 38"H
107221BT2XAM	01-30128	62/74	XLPE - SD 1.5	Natural	25.5" Dia x 38"H
107221BT2XAN	01-30139	62/74	XLPE - HD 1.9	Natural	25.5" Dia x 38"H
SQUARE TANKS					
108411F919AK	01-31922	5/7	LPE SD 1.5	Blue	14"L x 14"W x 13.5"H
108411F92XAK	01-31923	5/7	LPE SD 1.5	Natural	14"L x 14"W x 13.5"H
108411F919AL	01-31924	5/7	LPE HD 1.9	Blue	14"L x 14"W x 13.5"H
108411F92XAL	01-31925	5/7	LPE HD 1.9	Natural	14"L x 14"W x 13.5"H
108411F92XHG	01-31926	5/7	XLPE - SD 1.5	Natural	14"L x 14"W x 13.5"H
108411F92XSA	01-31927	5/7	XLPE - HD 1.9	Natural	14"L x 14"W x 13.5"H
108417N819AK	01-29816	10/12	LPE SD 1.5	Blue	14"L x 14"W x 22"H
108417N82XAK	01-29820	10/12	LPE SD 1.5	Natural	14"L x 14"W x 22"H
108417N819AL	01-30044	10/12	LPE HD 1.9	Blue	14"L x 14"W x 22"H
108417N82XAL	01-30048	10/12	LPE HD 1.9	Natural	14"L x 14"W x 22"H
108417N82XHG	01-30146	10/12	XLPE - SD 1.5	Natural	14"L x 14"W x 22"H
108417N82XSA	01-30151	10/12	XLPE - HD 1.9	Natural	14"L x 14"W x 22"H
108423V219AK	01-29333	20/25	LPE SD 1.5	Blue	18"L x 18"W x 24"H
108423V22XAK	01-29371	20/25	LPE SD 1.5	Natural	18"L x 18"W x 24"H
108423V219AL	01-30052	20/25	LPE HD 1.9	Blue	18"L x 18"W x 24"H
108423V22XAL	01-30056	20/25	LPE HD 1.9	Natural	18"L x 18"W x 24"H
108423V22XHG	01-30147	20/25	XLPE - SD 1.5	Natural	18"L x 18"W x 24"H
108423V22XSA	01-30152	20/25	XLPE - HD 1.9	Natural	18"L x 18"W x 24"H
108429AL19AK	01-29655	40/51	LPE SD 1.5	Blue	20"L x 20"W x 37.25"H
108429AL2XAK	01-29659	40/51	LPE SD 1.5	Natural	20"L x 20"W x 37.25"H
108429AL19AL	01-30060	40/51	LPE HD 1.9	Blue	20"L x 20"W x 37.25"H
108429AL2XAL	01-30064	40/51	LPE HD 1.9	Natural	20"L x 20"W x 37.25"H
108429AL2XHG	01-30148	40/51	XLPE - SD 1.5	Natural	20"L x 20"W x 37.25"H
108429AL2XSA	01-30153	40/51	XLPE - HD 1.9	Natural	20"L x 20"W x 37.25"H
108435CB19AK	01-29824	70/84	LPE SD 1.5	Blue	24"L x 24"W x 41"H
108435CB2XAK	01-29828	70/84	LPE SD 1.5	Natural	24"L x 24"W x 41"H
108435CB19AL	01-30068	70/84	LPE HD 1.9	Blue	24"L x 24"W x 41"H
108435CB2XAL	01-30072	70/84	LPE HD 1.9	Natural	24"L x 24"W x 41"H
108435CB2XHG	01-30149	70/84	XLPE - SD 1.5	Natural	24"L x 24"W x 41"H
108435CB2XSA	01-30154	70/84	XLPE - HD 1.9	Natural	24"L x 24"W x 41"H

C&M PART #	MFG PART #	CAPACITY (GAL) INNER/ OUTER	MATERIAL	COLOR	DIMENSIONS
SQUARE TANKS—RIBBED OUTER TANK					
108441DS19AK	01-32973	120/167	LPE SD 1.5	Blue	32"L x 32"W x 50"H
108441DS2XAK	01-32974	120/167	LPE SD 1.5	Natural	32"L x 32"W x 50"H
108441DS19AL	01-32975	120/167	LPE HD 1.9	Blue	32"L x 32"W x 50"H
108441DS2XAL	01-32976	120/167	LPE HD 1.9	Natural	32"L x 32"W x 50"H
108441DS2XHG	01-32978	120/167	XLPE - SD 1.5	Natural	32"L x 32"W x 50"H
108441DS2XSA	01-32980	120/167	XLPE - HD 1.9	Natural	32"L x 32"W x 50"H
108453NK19AK	01-33086	175/240	LPE SD 1.5	Blue	35"L x 35"W x 57"H
108453NK2XAK	01-33088	175/240	LPE SD 1.5	Natural	35"L x 35"W x 57"H
108453NK19AL	01-33087	175/240	LPE HD 1.9	Blue	35"L x 35"W x 57"H
108453NK2XAL	01-33089	175/240	LPE HD 1.9	Natural	35"L x 35"W x 57"H
108453NK2XHG	01-33091	175/240	XLPE - SD 1.5	Natural	35"L x 35"W x 57"H
108453NK2XSA	01-33093	175/240	XLPE - HD 1.9	Natural	35"L x 35"W x 57"H
SQUARE TANKS—REINFORCED					
108447DS19AK	01-29671	120/167	LPE SD 1.5	Blue	32"L x 32"W x 50"H
108447DS2XAK	01-29675	120/167	LPE SD 1.5	Natural	32"L x 32"W x 50"H
108447DS19AL	01-30076	120/167	LPE HD 1.9	Blue	32"L x 32"W x 50"H
108447DS2XAL	01-30080	120/167	LPE HD 1.9	Natural	32"L x 32"W x 50"H
108447DS2XHG	01-30150	120/167	XLPE - SD 1.5	Natural	32"L x 32"W x 50"H
108447DS2XSA	01-30155	120/167	XLPE - HD 1.9	Natural	32"L x 32"W x 50"H

**CHECK US OUT
ONLINE**

We're always adding new products.
Visit supply.coreandmain.com
for our latest additions.



Peabody ProChem® Process Chemical Tanks

The ProChem Process Chemical Tanks are designed for agricultural and industrial chemical applications where a single-walled design is desired. Most tanks (up to 300 gallons) include an integrally molded large pump mounting platform on top and standard process fittings for fill and discharge of chemicals, water or food products. Supplied with a vented access opening and easy-to-read calibration in liters and gallons. All LPE tanks and XLPE tanks 40 gallons and larger are NSF/ANSI/CAN 61 certified.



C&M PART #	MFG PART #	CAPACITY (GAL)	MATERIAL	LID SIZE	COLOR	DIMENSIONS
108340X22XAK	01-31272	25	LPE 1.5	8"	Natural	19.5" Dia x 26.25"H
108340X22XAL	01-31262	25	LPE 1.9	8"	Natural	19.5" Dia x 26.25"H
108340X22XAN	01-31322	25	XLPE 1.9	8"	Natural	19.5" Dia x 26.25"H
108343BC2XAK	01-31273	50	LPE 1.5	8"	Natural	19.5" Dia x 47.25"H
108343BC2XAL	01-31263	50	LPE 1.9	8"	Natural	19.5" Dia x 47.25"H
108343BC2XAN	01-31323	50	XLPE 1.9	8"	Natural	19.5" Dia x 47.25"H
108346BW2XAK	01-31267	65	LPE 1.5	8"	Natural	23" Dia x 43"H
108346BW2XAL	01-32891	65	LPE 1.9	8"	Natural	23" Dia x 43"H
108346BW2XAN	01-32894	65	XLPE 1.9	8"	Natural	23" Dia x 43"H
108349CG2XAK	01-31279	75	LPE 1.5	8"	Natural	27" Dia x 40"H
108349CG2XAL	01-31269	75	LPE 1.9	8"	Natural	27" Dia x 40"H
108349CG2XAN	01-31329	75	XLPE 1.9	8"	Natural	27" Dia x 40"H
108352DG2XAK	01-31274	100	LPE 1.5	8"	Natural	27" Dia x 47.75"H
108352DG2XAL	01-31264	100	LPE 1.9	8"	Natural	27" Dia x 47.75"H
108352DG2XAN	01-31324	100	XLPE 1.9	8"	Natural	27" Dia x 47.75"H
108355DU2XAK	01-31688	125	LPE 1.5	8"	Natural	27" Dia x 59.25"H
108355DU2XAL	01-31687	125	LPE 1.9	8"	Natural	27" Dia x 59.25"H
108355DU2XAN	01-31693	125	XLPE 1.9	8"	Natural	27" Dia x 59.25"H
108358NK2XAK	01-31860	175	LPE 1.5	8"	Natural	34" Dia x 55"H
108358NK2XAL	01-31660	175	LPE 1.9	8"	Natural	34" Dia x 55"H
108358NK2XAN	01-31663	175	XLPE 1.9	8"	Natural	34" Dia x 55"H
108361EM2XAK	01-31276	200	LPE 1.5	8"	Natural	34" Dia x 61"H
108361EM2XAL	01-31266	200	LPE 1.9	8"	Natural	34" Dia x 61"H
108361EM2XAN	01-31326	200	XLPE 1.9	8"	Natural	34" Dia x 61"H

C&M PART #	MFG PART #	CAPACITY (GAL)	MATERIAL	LID SIZE	COLOR	DIMENSIONS
108364XV2XAK	01-34798	265	LPE 1.5	8"	Natural	31" Dia x 90.625"H
108364XV2XAL	01-34799	265	LPE 1.9	8"	Natural	31" Dia x 90.625"H
108364XV2XAN	01-34800	265	XLPE 1.9	8"	Natural	31" Dia x 90.625"H
108367EQAKAB	01-33832	300	LPE 1.5	8"	Natural	34" Dia x 85"H
108367EQALAB	01-33833	300	LPE 1.9	8"	Natural	34" Dia x 85"H
108367EQANAB	01-33834	300	XLPE 1.9	8"	Natural	34" Dia x 85"H
108370EQAKAZ	01-31277	300	LPE 1.5	16"	Natural	48" Dia x 51.5"H
108370EQALAZ	01-31268	300	LPE 1.9	16"	Natural	48" Dia x 51.5"H
108370EQANAZ	01-31328	300	XLPE 1.9	16"	Natural	48" Dia x 51.5"H
108373FE2XAK	01-31278	525	LPE 1.5	16"	Natural	48" Dia x 77.5"H
108373FE2XAL	01-31270	525	LPE 1.9	16"	Natural	48" Dia x 77.5"H
108373FE2XAN	01-31330	525	XLPE 1.9	16"	Natural	48" Dia x 77.5"H
108376FF2XAK	01-33429	550	LPE 1.5	16"	Natural	73" Dia x 45"H
108376FF2XAL	01-33430	550	LPE 1.9	16"	Natural	73" Dia x 45"H
108376FF2XAN	01-33431	550	XLPE 1.9	16"	Natural	73" Dia x 45"H
108379FK2XAK	01-31280	750	LPE 1.5	16"	Natural	48" Dia x 112"H
108379FK2XAL	01-33006	750	LPE 1.9	16"	Natural	48" Dia x 112"H
108379FK2XAN	01-33009	750	XLPE 1.9	16"	Natural	48" Dia x 112"H
108382FQ2XAK	01-33046	1000	LPE 1.5	16"	Natural	73" Dia x 68"H
108382FQ2XAL	01-33047	1000	LPE 1.9	16"	Natural	73" Dia x 68"H
108382FQ2XAN	01-33048	1000	XLPE 1.9	16"	Natural	73" Dia x 68"H
108385FV2XAK	01-33050	1500	LPE 1.5	16"	Natural	73" Dia x 96"H
108385FV2XAL	01-33051	1500	LPE 1.9	16"	Natural	73" Dia x 96"H
108385FV2XAN	01-33052	1500	XLPE 1.9	16"	Natural	73" Dia x 96"H

UltraTech Burp-Free Funnel

Built-in vent - No more splashing or "burping" when pouring liquids!

FEATURES & BENEFITS

- Threaded brass insert screws into 2" drum bung
- All polyethylene construction won't rust or corrode - provides excellent chemical resistance
- Larger style provides bigger pouring area and easy access
- Hinged, Lockable lid prevents unauthorized access
- Protected by the industry's strongest warranty- Five (5) years against any material or workmanship defects
- Made in the USA



C&M PART #	MFG PART #	DESCRIPTION
10927923	0651	Standard Size Funnel
109279LG	0656	Large Size Funnel

Peabody Aquarius Tapered Chemical Feed Tanks



Aquarius Tapered Chemical Feed Tanks nest nicely inside one another to save you money on shipping and storage. These polyethylene (PE) chemical feed tanks have a 22-degree mixer mounting surface, 100# rated pump surface with recessed collection reservoir, a 4" inspection port and two 2" NPT(F) fittings. Standard colors are translucent white, Gemini blue, yellow or black; other custom colors are available on request. Standard tanks are NSF/ANSI/CAN 61 certified. XLPE, PPL and PVDF tanks are available on request.

C&M PART #	MFG PART #	CAPACITY (GAL)	MATERIAL	WALL THICKNESS	COLOR	DIMENSIONS
108395Z119AK	01-28643	30	LPE 1.5	3/16"	Blue	27" Dia x 21.25"H
108395Z12XAK	01-28641	30	LPE 1.5	3/16"	Natural	27" Dia x 21.25"H
108395Z1D7AK	01-28642	30	LPE 1.5	3/16"	Yellow	27" Dia x 21.25"H
108395Z117AK	01-28644	30	LPE 1.5	3/16"	Black	27" Dia x 21.25"H
108395Z119AL	01-28647	30	LPE 1.9	5/16"	Blue	27" Dia x 21.25"H
108395Z12XAL	01-28645	30	LPE 1.9	5/16"	Natural	27" Dia x 21.25"H
108395Z1D7AL	01-28646	30	LPE 1.9	5/16"	Yellow	27" Dia x 21.25"H
108395Z117AL	01-28648	30	LPE 1.9	5/16"	Black	27" Dia x 21.25"H
108403BJ19AK	01-28651	55	LPE 1.5	3/16"	Blue	27" Dia x 35.5"H
108403BJ2XAK	01-28649	55	LPE 1.5	3/16"	Natural	27" Dia x 35.5"H
108403BJD7AK	01-28650	55	LPE 1.5	3/16"	Yellow	27" Dia x 35.5"H
108403BJ17AK	01-28652	55	LPE 1.5	3/16"	Black	27" Dia x 35.5"H
108403BJ19AL	01-28655	55	LPE 1.9	5/16"	Blue	27" Dia x 35.5"H
108403BJ2XAL	01-28653	55	LPE 1.9	5/16"	Natural	27" Dia x 35.5"H
108403BJD7AL	01-28654	55	LPE 1.9	5/16"	Yellow	27" Dia x 35.5"H
108403BJ17AL	01-28656	55	LPE 1.9	5/16"	Black	27" Dia x 35.5"H

Peabody ProChem® ClamShell Funnels



Transfer chemicals safely and efficiently from D.O.T. pails, jerry cans and buckets into your Gemini® and ProChem storage tanks, drums, IBC's, tanks, or any other container with an 8" or smaller opening with the ProChem® ClamShell Funnel. Constructed from durable lightweight linear polyethylene, it is highly chemical resistant. Scalloped clamshell design with integral molded-in ridges direct flow toward the tank opening and help reduce splashing. Smooth inner surface allows for efficient flow of product from pail or bucket into tank and easy clean-up after filling. Optional cover available to contain residue and odors. Optional lanyard is also available to attach lid to funnel, call for ordering information.

C&M PART #	MFG PART #	APPLICATION	FITS LID	COLOR
108388	02-32819	Drums	2"	Black
108389	02-31977	IBC's	4 to 6"	Black
108390	02-31951	Tanks	8"	Black

REPLACEMENT PARTS & ACCESSORIES

C&M PART #	MFG PART #	DESCRIPTION	COLOR
108391	02-33045	Funnel Cover	Black

Peabody Gemini² MCU™ Tanks



The Gemini MCU (multiple chemical unit) store multiple chemicals in a single, multi-compartment, dual containment tank. Configure two, three or four different liquids in one compact space, with two separate containment chambers that are as flexible as you need them to be. The individual primary tanks are available in 6- and 12-gallon sizes. Configure your tank with two 12-gallon tanks, one 12-gallon and two 6-gallon tanks or four 6-gallon tanks, all in one compact space. Great for set-ups, chemical feed systems or any other application where you require multiple chemicals with limited space for storage. An optional overhead PumpDeck™ is available to integrally mount to the MCU with room for up to 4 metering pumps.

C&M PART #	MFG PART #	TANKS	MATERIAL	COLOR	DIMENSIONS
108392	01-31895	(2) 12-Gal	LPE 1.5	Blue	25"L x 25"W x 25"H
108393	01-31896	(1) 12-Gal (2) 6-Gal	LPE 1.5	Natural	25"L x 25"W x 25"H
108394	01-31897	(4) 6-Gal	LPE 1.5	Blue	25"L x 25"W x 25"H

Tanks

Chemical Solution Tanks

Stenner STS Polyethylene Chemical Solution Tanks

The lightweight and rugged STS Polyethylene Chemical Solution Tanks are perfect for storing chemical solutions. Each tank has incremental solution level indicators and come with a polypropylene lid. Select from UV-resistant gray or translucent white.

Viton grommets and stainless-steel screws provide excellent chemical resistance. Tanks work with Stenner Pump models: 45, 85, S30, S40, S34, S44, S3P, S4M and Econ® pumps (except E10T01 and E20T01—order mounting kit below.)



C&M PART #	MFG PART #	CAPACITY (GAL)	COLOR
105678	STS15NC	15	Translucent
105679	STS15GC	15	UV Gray
105680	STS30NC	30	Translucent
105681	STS30GC	30	UV Gray

REPLACEMENT PARTS & ACCESSORIES

C&M PART #	MFG PART #	DESCRIPTION
105682	EC303	Econ Pump Mounting Kit for Stenner STS Tank (required for E10T01 and E20T01)

Pulsafeeder Heavy-Duty Chemical Solution Tanks



These tapered HDPE Chemical Solution Tanks feature rigid covers that accommodate top mounting of CHEM-TECH 100, 200, most PULSAtron pump models and 1/20-hp flange mount mixers. The covers feature a 4.5" refill cap, 1.4" cap pump accessories and two 3.5" indent for mounting accessories. Tanks are translucent and come with 5-gallon graduations.

Note: Not suitable for use with 1/3 HP Flange Mount Mixers.

C&M PART #	MFG PART #	CAPACITY (GAL)	DIMENSIONS (Dia x H)	CONFIGURATION
105478	40365	35	23" x 28"	Top Mount
105479	J40366	50	23" x 42.5"	Top Mount

LMI Chemical Solution Tanks

Use these Chemical Solution Tanks to store most corrosive and noncorrosive solutions.

The slightly translucent 10 Gallon Tank allows you to check the solution level at a glance. Large fill hole at top allows easy replenishing of solution. Tank features a recess for mounting a LMI pump.

Use the 35 Gallon Tank for flooded suction or suction lift application. For a flooded suction application (which is ideal for off-gassing chemicals and applications where very low output is required), place the LMI pump recess area near the bottom of the tank. For a suction lift application, place the LMI pump on the molded recess at the top of the tank. Tank includes a shut off valve, discharge tubing retainer and large fill hole.

The 50 Gallon Tank has a high rigidity black polyethylene cover with molded recess for mounting of a LMI pump and has self-supporting, tapered sides.

FEATURES & BENEFITS

- UV resistant, yellow polyethylene tank
- Suitable for most corrosive and noncorrosive solutions
- 5-gallon (20 liter) graduations



CERTIFICATIONS

- Certified to NSF/ANSI Standard 61 and 372

C&M PART #	MFG PART #	CAPACITY (GAL)	DIMENSIONS (Dia x H)	CONFIGURATION
107042	27421	10	14" x 18"	Top Mount
107043	27400	35	20" x 31"	Flooded Suction or Top Mount
107044	26350	50	23" x 42-3/4"	Top Mount

Tools



TABLE OF CONTENTS

Chisels & Punches	422
Hammers & Mallets	423
Levels	424
Tape Measures	424
Pipe Tools/Vises	425
Pliers	425-428
Power Tools & Accessories	428-448
Drill Bits	448-450
Grinding Wheels & Discs	451
Hole Saw Sets	451
Saws & Saw Blades	452-453
Wire Brushes	454
Scrapers & Utility Knives	454-455
Screwdrivers	456-457
Screwdriver Sets	458
Sockets & Socket Accessories	459
Tool Sets	460
Tool Storage	460-462
Wrenches	463-468

Cold Chisel and Punch Set

The Stanley Cold Chisel & Punch Set are constructed of one-piece, forged chrome vanadium steel for increased strength and durability. Size marking on shank allows for easy identification of the tool. Yellow powder-coated finish provides high visibility and corrosion resistance. Striking surface is hardened and has chamfered edges for greater chipping resistance.

Punch edge is ground to a precise angle for efficient punching and durability.



STANLEY

INCLUDES

Punch - 1/16", 3/32", 1/8", 5/32", 3/16", (2)1/4", (2)5/16"; Cold Chisel - 3/8", 1/2", 5/8"

C&M PART #	MFG PART #	DESCRIPTION
106577	16-299	Cold Chisel & Punch, 12-Piece Set

Radians® Deterrent® 32 Disposable Foam Earplugs



The Deterrent 32 Disposable Foam Earplugs feature soft, slow-recovery foam for extreme comfort and outstanding noise reduction to protect your hearing. The earplugs are easy to roll down and insert and expand slowly for a low-pressure fit in virtually any size ear canal. Available in both corded and uncorded. The corded model comes with a PVC dielectric cord to conveniently hang around neck.

FEATURES & BENEFITS

- Comfortable wing shape
- Dual color—yellow and green
- Extremely soft foam

CERTIFICATIONS

- ANSI S3.19

C&M PART #	MFG PART #	DESCRIPTION	QUANTITY
100435	FP35	Corded	200 Pairs/Box
100436	FP34	Non-corded	200 Pairs/Box
100044	FP34BG50	Non-corded	50 Pairs/Bag

SUGGESTED PRODUCTS

Scrubs In-A-Bucket Hand Cleaner Towels

Scrubs-in-a-Bucket Hand Cleaner Towels are premoistened wipes specifically designed for cleaning hands when water and soap are not readily available. These towels are often used in automotive, construction and manufacturing industries where workers need a convenient way to clean their hands from dirt, grease, oil or other stubborn substances. The towels are infused with cleaning agents, moisturizer and citrus fragrance to effectively remove grime while keeping the skin hydrated and smelling good.



C&M PART #	MFG PART #	TOWEL SIZE	COLOR	QUANTITY
108050	34744	10" x 12"	Blue	72/Bucket

Radians® Ghost™ Series Level A2 Cut Protection Work Gloves

The Ghost Series RWG5550 Gloves have an ANSI cut rating of 2 and an EN388 cut rating of 2. A 13-gauge, high-performance polyethylene (HPPE) shell with polyurethane coating provides a comfortable fit in hazardous applications. It is often used in work environments with sharp objects, like HVAC, construction and manufacturing. Sold as a pair.



FEATURES & BENEFITS

- Tested to EN 388:2016 Standards for Abrasion Resistance, Blade Cut, Tear, and Puncture (4 2 4 2)
- Polyurethane palm dip provides protection from abrasion in wet or dry conditions
- Seamless design provides a comfortable fit

SPECIFICATIONS

LOAD WEIGHT	548 g
MATERIAL	HPPE
PALM	Polyurethane
CUFF STYLE	Seamless Comfort Cuff

CERTIFICATIONS

- EN 388:2016 Standards, ANSI Cut Level A2, and EN388 Cut Level 2

C&M PART #	MFG PART #	SIZE
100382MD	RWG550M	M
100382LG	RWG550L	L
100382XL	RWG550XL	XL

Stanley FatMax® Rip Claw Hammer



Stanley FatMax® hammer is engineered with your safety in mind. The ergonomic dual density grip design reduces the effect of torque on the wrist and elbows while AntiVibe® technology minimizes vibration and shock on impact. A 75% larger striking face than traditional hammers and balanced heads improve accuracy. Slip-resistant handle ensure a secure grip and comfort.

C&M PART #	MFG PART #	DESCRIPTION
106578	51-163	Rip Claw Hammer, 16 oz

Rhino Manhole Lid Extractor / Sledge Hammers

The Jake and Mary A is a manhole cover, inlet cover, or grate extractor used for manhole or storm inlet inspections and systems maintenance. The combination sledge hammer and pick/pry bar eliminates the need to carry two tools.



FEATURES & BENEFITS

- Cast steel head helps break frozen covers or grates loose very quickly where they may be removed
- The smooth pick is constructed to virtually open any manhole cover
- Serrated edge strengthens pick-end and eliminates possibility of tool becoming bottle necked in the pick bars, pick holes or grate slots
- Heat-treated cast steel head, handle is constructed of sturdy Nupla® fiberglass with ribbed hand grip

C&M PART #	MFR PART #	DESCRIPTION
104856	Mary A	Rhino Mary A 12lb, Manhole Lid Extractor/ Sledge Hammer
104857	Jake	Rhino Jake 8lb Manhole Lid Extractor/Sledge Hammer

Nupla Hammers & Mallets

Ball Pein Hammer: A versatile tool commonly found in metalworking, blacksmithing and other applications where controlled striking and shaping of metal are required.



Brass Sledgehammer: For applications where sparks or damage to the struck surface must be avoided, such as working with flammable materials or delicate surfaces.

Extreme Power Drive Mallet: Used for applications in various fields, including automotive repair, woodworking, metalworking and general maintenance tasks. They are particularly useful when working with softer materials, fragile components, or delicate finishes.

Rubber Mallet: Commonly employed for tasks such as driving dowels or wooden joints together, installing flooring, assembling furniture or striking objects that could be easily damaged by a regular metal hammer.

White Rubber Mallet: Preferred in certain applications where the color of the mallet is important for aesthetic reasons or to prevent color transfer onto the struck surface.

Hand Drilling Hammer: A specialized hammer used for striking chisels, punches or other tools in various applications, particularly in metalworking and masonry tasks.



C&M PART #	MFG PART #	DESCRIPTION
A BALL PEIN HAMMER		
104865	75.21-016	16 oz Ball Pein Hammer, Classic Handle, H Grip
B BRASS SLEDGEHAMMERS		
104875	75.30-015	1.5 lb Brass Sledgehammer, Classic Handle, SG Grip
104876	75.30-025	2.5 lb Brass Sledgehammer, Classic Handle, SG Grip
C EXTREME POWER DRIVE MALLETS		
104858	75.10-062	2 lb Extreme Power Drive, SG Grip
104859	75.10-063	3 lb Extreme Power Drive, SG Grip
104860	75.10-066	2 lb Extreme Power Drive, One Steel Face, SG Grip
D RUBBER Mallet		
104862	75.13-120	2 lb Rubber Mallet, H Grip
E WHITE RUBBER Mallet		
104861	75.13-115	1 lb Premium Non-Marking White Head Rubber Mallet, H Grip
F HAND DRILLING HAMMERS		
104873	75.28-025	2 lb Hand Drilling, 10" Classic Handle, SG Grip
104874	75.28-035	3 lb Hand Drilling, 10" Classic Handle, SG Grip

DeWalt Laser Levels

The DeWalt Laser Level is used in construction and carpentry to project a straight and level laser beam onto a surface. It helps ensure accurate and precise alignment, whether it's for installing shelves, hanging pictures, laying tiles, or other tasks that require straight lines or level surfaces.



SPECIFICATIONS

C&M PART #	106579	106580	106581
LASER TYPE	Green Beam Laser Technology		
LASER COLOR	Green		
LASER POWER (mW)	≤1.0	<1.3	≤1.50
ACCURACY	±1/8" per 33 ft		
VISIBILITY RANGE (ft)	100 (165 with Detector*)	100 (330 with Detector*)	115 (165 with detector*)
BATTERY TYPE	12 V Max CXT	(3) AA (Alkaline)	12 V Max CXT
OPERATING TEMPERATURE	14 to 122°F (-10 to 50°C)		
STORAGE TEMPERATURE	-5 to 140°F (-20 to 60°C)		
RATING	IP65	IP54	IP65
BATTERY LIFE (hr)	14	16	14
MAGNETIC	Yes		
DIMENSIONS (L x H x D)	13-3/4" x 7" x 13-3/4"	9-1/4" x 4-1/4" x 9-1/4"	6-1/8" x 12-1/2" x 6-1/8"
WEIGHT (lbs)	7.85	3.52	9.12

*Detector sold separately

C&M PART #	MFG PART #	DESCRIPTION
106579	DW0825LG	5 Spot + Cross Line Laser
106580	DW088CG	Cross Line Laser
106581	DW089LG	3 x 360 Green Line Laser

Reed Torpedo Levels



The Reed Torpedo Levels are designed for plumbing and waterworks that gives accurate slope measurements with the pitch vial. V-groove shape permits placement on pipe. Flat edge tips at 45 degrees allow for angle measurements and transfers for the plumbing torpedo level while the waterworks torpedo level tips at 45 degrees and 30 degrees.

C&M PART #	MFG PART #	DESCRIPTION	LENGTH	WEIGHT (LBS)	MATERIAL
103494	06213	Plumbing Torpedo Level	9"	0.5	Aluminum
103495	06214	Waterworks Torpedo Level	6-1/2"	0.6	Aluminum

Stanley FatMax® Tape Measures



The Stanley FatMax® tapes fit your toolbelt and engineered to fit nicely in your hand for easy measurements on the job. ABS housing and steel tape construction provide durability even with heavy use. A protective blade coating on the entire blade helps extend the life of your tapes plus 9" of BladeArmor® coating offers even more hook protection. The 25- and 35-ft tapes feature a patented Twin-Core™ technology for a compact case design and a baseball-inspired grip to fit comfortably in your hand.

C&M PART #	MFG PART #	LENGTH (ft)	TAPE WIDTH	MAX REACH (ft)*
106584	FMHT33316S	16	1.25"	14
106585	FMHT36325THS	25	1.25"	17
106586	FMHT36335THS	35	1.25"	17

*To get measurements on your own

Stanley PowerLock® Tape Measures



The Stanley PowerLock® Tape Measure gives the durability and dependability you need with its BladeArmor® coating. Draw circles and arcs and easily frame a wall using the 16" and 19-1/5" stud center markings while the Tru-Zero® end hook helps deliver reliable accuracy. The Mylar-coated blade resists wear-and-tear for long life. ABS housing and steel tape construction provide durability even with heavy use. Use the blade lock feature to keep the tape measure securely in place as you work.

C&M PART #	MFG PART #	LENGTH (ft)	TAPE WIDTH
106582	33-425	25	1"
106583	33-430	30	1"

IRWIN® Heavy-Duty Workshop Vise



The Heavy-Duty Workshop Vise features a captured safety jaw to prevent the slide from falling out during use. At a solid 30.6 lbs., this anvil and pipe jaw incorporated table vise maneuvers quickly into position with a swivel base. An aggressive set of steel jaws maintain a secure hold to grip tightly and hold fast for steady work.

FEATURES & BENEFITS

- Swivel base
- Anvil and pipe jaws incorporated.
- Aggressive steel jaws

C&M PART #	MFG PART #	MOUNTING	JAW WIDTH	MAX. JAW OPENING	WEIGHT (lbs)
106587	226306ZR	Workbench Top	6"	5"	31.88

IRWIN® Vise-Grip® Diagonal Cutting Pliers



These Vise-Grip Diagonal Cutting Pliers are constructed of durable alloy steel with a laser heat-treated cutting edge to stay sharper longer. These cutting pliers feature two-zone contoured grips for increased comfort and control. ProTouch™ grips provide extra comfort and reduce hand fatigue.

CERTIFICATIONS

- Meets or exceeds ANSI specifications

C&M PART #	MFG PART #	TYPE	MATERIAL	NOSE TYPE	LENGTH
106592	1968332	Angled Head	High-Carbon Alloy Steel	Oval	6"
106608	2078308	Flush/Straight	Nickel Chromium Steel	Oval	8"

IRWIN® Vise-Grip® Long Nose Pliers



The Vise-Grip Long Nose Pliers with Wire Cutter have an induction hardened cutting edge that stays sharper longer. The machined jaws provide maximum gripping strength. The Long Nose Pliers also have ProTouch™ grips that have molded handles for comfort and create less hand fatigue. All pliers meet or exceed ANSI specifications.

C&M PART #	MFG PART #	TYPE	MATERIAL	NOSE TYPE	LENGTH
106606	2078216	Cutting & Gripping	Nickel Chrome Steel	Long	6"
106607	2078218	Cutting & Gripping	Nickel Chrome Steel	Long	8"

Klein® Diagonal Cutting Plier



Klein Diagonal Cutting Pliers are made with US-made forged steel to provide the highest durability. Diagonal cutting pliers, also known as wire cutters or side cutters, are specifically designed to cut through wires and other materials with precision. The hot-riveted joint on angled-head and high-leverage pliers ensures smooth action with no handle wobble. The flush cutter features a steel return spring for increased comfort during repetitive cutting.

C&M PART #	MFG PART #	TYPE	LENGTH	JAW CAPACITY	HANDLE COLOR
112266	D200048	Angled Head	8"	1.375"	Blue
112270	J200048	Heavy-Duty Angled Head	8"	0.75"	Light Blue/Black
112268	D2488	Short Jaw Angled Head	8"	0.75"	Red
112267	D2287	High Leverage	7"	1.031"	Red
112269	D2755	Flush Cutter	5"	0.2"	Red



IRWIN® Vise-Grip® Locking Pliers & Clamps

Irwin is revolutionizing the world of groove joint pliers with the introduction of Vise-Grip GrooveLock™ pliers. With patented metal injection molding (MIM) technology, these pliers are precisely made to adjust 2x faster and have twice the groove positions than standard groove joint pliers. These innovative features allow you to grip work pieces faster and easier than ever before.

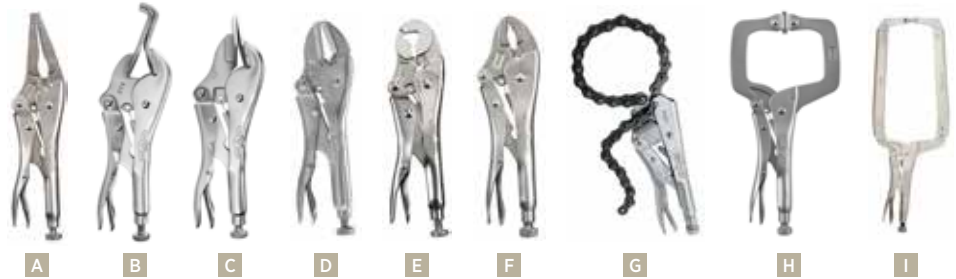

C&M PART #	MFG PART #	DESCRIPTION	LENGTH
A LONG NOSE LOCKING PLIER W/WIRE CUTTER			
106598	1402L3	Long Nose Plier with Wire Cutter	6"
106599	1502L3	Long Nose Plier with Wire Cutter	9"
B U-JAW WELDING CLAMP PLIER			
106625	251	U-Jaw Welding Clamp Plier	9"
C SHEET METAL PLIER			
106624	23	Sheet Metal Plier	8"
D STRAIGHT-JAW LOCKING PLIERS			
106594	302L3	Straight-Jaw Locking Plier	7"
106615	IRHT82577	Straight-Jaw Locking Plier Reduced Handle	7"
106616	102L3	Straight-Jaw Locking Plier	10"
E WRENCH VISE GRIP PLIERS			
106613	4	Wrench Locking Plier	7"
106614	2	Wrench Locking Plier	10"

C&M PART #	MFG PART #	DESCRIPTION	LENGTH
F CURVED JAW LOCKING PLIERS			
106596	702L3	Curved-Jaw Locking Plier with Wire Cutter	7"
106611	4935576	Curved-Jaw Locking Plier	10"
106595	502L3	Curved-Jaw Locking Plier	10"
G LOCKING CHAIN CLAMP			
106623	27ZR	Chain Clamp	9"
H LOCKING C-CLAMPS WITH SWIVEL PADS			
106619	18	C-Clamp with Swivel Pads	6"
106620	20	C-Clamp with Swivel Pads	11"
106622	22	C-Clamp with Swivel Pads	18"
I LOCKING C-CLAMPS WITH FIXED PADS			
106617	17	C-Clamp with Fixed Pads	6"
106618	19	C-Clamp with Fixed Pads	11"
106621	21	C-Clamp with Fixed Pads	18"

IRWIN® Vise-Grip® Needle Nose Plier with Spring



The Vise-Grip Needle Nose Plier with Spring provides high leverage and gripping force even when working with small items. Constructed of nickel chromium steel, the pliers offer excellent durability and long service life. Spring-loaded feature and the ProTouch™ grip help reduce hand fatigue.

C&M PART #	MFG PART #	DESCRIPTION	LENGTH
106609	2078955	Vise-Grip Needle Nose Plier with Spring	5.5"

IRWIN® Vise-Grip® Slip Joint Plier



The Vise-Grip Slip Joint Plier has an induction hardened cutting edge that stays sharper longer. The jaws are machined for maximum gripping strength. The plier also has ProTouch™ grips that have molded handles for comfort and create less hand fatigue. All pliers meet or exceed ANSI specification.

C&M PART #	MFG PART #	DESCRIPTION	MATERIAL	LENGTH
106601	2078408	Slip Joint Plier	Nickel chromium steel	8"



IRWIN® Vise-Grip® Plier Sets

A GrooveLock 2-Piece Plier Set - These Vise-Grip GrooveLock™ pliers utilize the Press-n-Slide button for 2x faster adjustment than traditional groove joint pliers. Nonslip, anti-pinch ProTouch™ grips provide increased comfort and reduced hand fatigue. A patented metal injection molding (MIM) process ensures precision and long life. Set includes a 6" and 8" V-jaw pliers.

B GrooveLock 8-Piece Plier Set - The Vise-Grip GrooveLock 8-Piece Pliers Set features the most used tools all in one convenient bag. These pliers utilize the Press-n-Slide button for 2x faster adjustment than traditional groove joint pliers. Nonslip, anti-pinch ProTouch grips provide increased comfort and reduced hand fatigue. A patented metal injection molding (MIM) process ensures precision and long life. This set includes 6" diagonal cutting, 6" slip joint, 8" long nose, 8" linesmen and three GrooveLock (8", 10" and 12") pliers as well as the adjustable wrench. Backed by the IRWIN Lifetime Guarantee.

C Traditional 4-Piece Plier Set - All pliers are constructed from durable nickel chromium steel for excellent durability and feature machined jaws for maximum gripping strength. Anti-pinch, nonslip ProTouch Grips provide comfort, control, and less hand fatigue. This set includes 6" diagonal cutting, 6" slip-joint, 8" long nose, and 10" groove joint pliers. Variable-size jaws on slip-joint plier is a flexible solution for most household needs. Use the long-nose plier easily reach into confined areas. Tool wrap rolls small to store easily.

D Fast Release 7-Piece Locking Plier Set - The Vise-Grip Fast Release™ Locking Pliers are built with heat-treated alloy steel for maximum durability. The hardened teeth on the pliers grip from any angle and have a one-handed triggerless release. This set includes Fast Release 7" and 10" straight jaw, 10" curved jaw, 6" long nose and original 9" long nose, 5" and 7" curved jaw with wire cutter. A convenient bag stores tools and rolls up easily for transporting.

E Original 10-Piece Locking Plier Set - The Vise-Grip Original Locking Pliers are built with high-grade, heat-treated alloy steel construction for maximum toughness and durability. Hardened teeth on the pliers grip from any angle and a classic trigger release provides maximum locking force. This set includes 6", 7" and 10" straight jaw; 5", 7" and 10" curved jaw; 6" and 9" long nose, 7" locking wrench and 11" C-clamp. A convenient kit bag stores tools for easy transport.



C&M PART #	MFG PART #	DESCRIPTION
A GROOVELOCK 2-PIECE PLIER SET		
106626	1802531	GrooveLock 2-Piece Plier Set
B GROOVELOCK 8-PIECE PLIER SET		
106602	2078712	GrooveLock Plier 8-Piece Set
C TRADITIONAL 4-PIECE PLIER SET		
106610	2078707	Plier 4-Piece Set, Traditional
D FAST RELEASE 7-PIECE LOCKING PLIER SET		
106627	IRHT82595	Fast Release 7-Piece Locking Pliers Set w/ Reduced Hand Span
E ORIGINAL 10-PIECE LOCKING PLIER SET		
106593	1078KB	Original 10-Piece Locking Plier Set

KEEP YOUR HANDS PROTECTED

To view our full selection of hand protection, view the **Safety** section on **pages 342-350** or visit supply.coreandmain.com



IRWIN® Hand Snips



The Irwin hand snips feature a compound cutting action with textured grips and easy close latch. They are great for cutting sheet metal, vinyl, plastic, rubber and many other materials.

C&M PART #	MFG PART #	PRODUCT TYPE	CUT	MATERIAL	LENGTH
106603	2073113	Aviation Snips	Straight	Steel	10"
106604	2073211	Multipurpose Snips	Straight	Steel	9.5"
106605	21304ZR	Multipurpose Snips	Straight	Steel	11.75"

DeWALT® 20 V MAX Corded/Cordless Air Inflator

DeWALT 20 V MAX Corded/Cordless Air Inflator can run on DeWALT 20V MAX battery, 12 VDC or 110 VAC for maximum versatility. The threaded chuck and included onboard accessories make it easy to inflate items from tires to footballs. Setting desired air pressure is simple with the digital gauge, and the auto-shutoff provides accurate inflation. The high-pressure, high-volume hose allows fast inflation of mattresses and other inflatables with the push of a button. Move the hose to the deflation port for quick and easy take down. An onboard LED light helps to provide illumination in dark spaces. Heavy-duty rubber feet help reduce walking while in use.



FEATURES & BENEFITS

- High-pressure inflation mode with automatic shutoff
- High-volume inflation and deflation modes
- Three power sources for inflation on a jobsite and on the go (DEWALT 20 V MAX battery, 12 VDC, or 110 VAC)
- LED light helps to provide illumination

INCLUDES

DCC020I air inflator, 12 VDC power cord, high-pressure tapered nozzle, presta valve adapter and inflator needle

C&M PART #	MFG PART #	DESCRIPTION
106628	DCC020IB	20 V MAX Corded/Cordless Air Inflator

Klein® Long Nose Plier



Klein Long Nose Pliers, also known as needle-nose pliers, have a long, narrow, and tapered jaw that allows for precise gripping, bending, cutting and manipulating of small objects or wires in tight spaces. These pliers are commonly used in electrical work, electronics and other applications where fine control and reach are required.

C&M PART #	MFG PART #	TYPE	MATERIAL	NOSE TYPE	LENGTH
112265	J2078CR	Gripping & Crimping	Alloy	Long	8.5"
112271	D2038	Cutting & Gripping	Alloy	Long	8"

DeWALT® 20 V MAX Brushless 1-1/2" Variable-Speed Cordless Die Grinder, Tool Only



DeWALT 20 V MAX Brushless 1-1/2" Variable-Speed Cordless Die Grinder (tool only) offers a longer motor life and no brush changes. Powerful motor delivers 500 MWO and up to 25000 rpm. And, with its dual-position rocker switch, you can choose from multiple ways to grasp the handle.

FEATURES & BENEFITS

- Brushless motor requires no brush changes
- Variable speed rocker switch and variable speed limit switch settings provide options to control speed of the tool
- LED lights at the nose of tool provide light for the work surface and area
- Dual-position rocker switch provides user options for multiple handle grasping points

INCLUDES

DCG426 die grinder, 1/4" collet and two wrenches

C&M PART #	MFG PART #	DESCRIPTION
106629	DCG426B	20 V MAX Brushless 1-1/2" Variable-Speed Cordless Die Grinder, Tool Only

REPLACEMENT PARTS & ACCESSORIES

C&M PART #	MFG PART #	DESCRIPTION
106637	DCB205-2	20 V MAX XR® 5 Ah Battery, 2/Pack

DeWALT® 4-1/2" Small Angle Grinder with One-Touch Guard



DeWALT 4-1/2" (115 mm) Small Angle Grinder with One-Touch™ Guard has a 7 amp motor for fast material removal. One-Touch guard eliminates the need for a tool to adjust the guard location.

FEATURES & BENEFITS

- 7 amp AC/DC, 12,000 rpm motor designed for faster material removal and higher overload protection
- Hex wrench replaces spanner wrench - hex wrench is found in most tool boxes if lost
- Low-profile, jam-pot gear case increases durability and allows tool to fit into tight spaces

INCLUDES

2-position side handle, depressed center wheel, One-Touch™ guard and hex wrench

C&M PART #	MFG PART #	DESCRIPTION
106630	DWE4011	4-1/2" Angle Grinder, 120 VAC

DeWALT® 4-1/2" Heavy-Duty Small Angle Grinder



DeWALT 4-1/2" (115 mm) Heavy-Duty, Small Angle Grinder with a powerful 11 amp AC/DC, 11,000 rpm motor provides the best power to weight/size ratio available. A unique dust ejection system ejects damaging dust and debris particles that enter the tool. One-Touch™ guard allows the guard to rotate 360-degrees; Quick-Change™ wheel release offers easy wheel removal.

FEATURES & BENEFITS

- Dust ejection system provides durability by ejecting damaging dust and debris particles that enter the tool
- Oversized brushes provide 65% longer brush life over previous model (D28402)
- Large spiral bevel gear provides long transmission life

INCLUDES

2-position side handle and 4-1/2" One-Touch guard

C&M PART #	MFG PART #	DESCRIPTION
106631	DWE402	Heavy-Duty Small Angle Grinder, 4-1/2"

DeWALT® High-Performance 6" Paddle Switch Grinder

DeWALT 6" (150 mm) High-Performance Paddle Switch Grinder with E-Clutch® system instantly shuts the grinder off when a wheel pinch or wheel stall occurs, extending the life of the gears and motor. Dust ejection system clears dust and debris from grinder for extra protection. Power Loss Reset® helps prevent accidental restarts following a power disruption when the tool is left in the "on" position.

FEATURES & BENEFITS

- E-Clutch system activates in less than a tenth of a second when a pinch/stall is detected, shutting down the motor
- Powerful 13 amp motor delivers speeds up to 9000 rpm
- Dust ejection system ejects damaging dust and debris particles that enter through the air intake vents for longer service life



INCLUDES

DWE43144 grinder, 6" Type 27 guard, 6" Type 1 guard, side handle, hex key, and inner and outer flange

C&M PART #	MFG PART #	DESCRIPTION
106632	DWE43144	High-Performance Paddle Switch Grinder, 6"



DeWALT® Battery Packs and Chargers

A 20 V MAX Battery packs will power DeWALT 20 V MAX tools with a 3 LED charge indicator feature.

B 20 V/60 V MAX FLEXVOLT® Battery is a dual-voltage 20 V/60 V that automatically changes voltage when you change tools. The FLEXVOLT can provide up to 6x runtime in 20 V MAX tools (compared to 1.5 Ah battery) and the power of corded in 60 V MAX and 120 V MAX tools.

C 20 V MAX POWERSTACK Battery has a 25% smaller footprint and 50% more power compared with using batteries that work with the 20 V MAX tools and chargers you already have.

D 18 to 20 V Adapter allows you to use selected DeWALT 20 V MAX lithium ion slide pack batteries with DeWALT 18 V power tools. *** Battery pack sold separately

Notes: Order DeWALT battery pack chargers separately



BATTERY PACKS & ADAPTERS

C&M PART #	MFG PART #	DESCRIPTION	QUANTITY
A 20 V MAX BATTERIES			
106636	DCB204-2	20 V MAX XR 4 Ah Lithium Ion Batteries	2
106637	DCB205-2	20 V MAX XR 5 Ah Batteries	2
106638	DCB206-2	20 V MAX Premium XR 6.0 Ah Lithium Ion Batteries	2
106640	DCB240-2	20 V MAX Compact 4 Ah Batteries	2
106641	DCB324-4	20 V MAX Lithium Ion Batteries	4
B 20 V/60 V MAX FLEXVOLT® BATTERIES			
106642	DCB609	20 V/60 V MAX FLEXVOLT 9.0 Ah Battery	1
106643	DCB609-2	20 V/60 V MAX FLEXVOLT 9.0 Ah Batteries	2
106639	DCB606-2	20 V/60 V MAX FLEXVOLT 6.0 Ah Batteries	2

C&M PART #	MFG PART #	DESCRIPTION	QUANTITY
C 20 V MAX POWERSTACK BATTERY			
106644	DCBP034-2	20 V MAX POWERSTACK Compact Batteries	2
D 18 TO 20 V ADAPTER			
106645	DCA1820	18 to 20 V Adapter	1

BATTERY PACK CHARGERS

C&M PART #	MFG PART #	DESCRIPTION
106646	DCB104	Charger for 20 V MAX & FLEXVOLT
106647	DCB115	Charger for 20 V MAX Batteries

DeWALT® 20 V MAX Battery Starter Kits



The DeWALT 20 V MAX Starter Kit includes a premium XR® 6.0 Ah battery, a compact 4.0 Ah battery and DCB115 charger, all in a convenient carrying bag. Both batteries are compact and lightweight, providing ergonomic benefits for increased tool maneuverability and control for overhead applications.

The DeWALT 20 V MAX XR® Lithium-Ion Starter Kit comes with two premium 5.0 Ah batteries, charger and kit bag.



FEATURES & BENEFITS

- Charges all DEWALT 12 V, 20 V and 60 V MAX batteries at a 4-amp charge rate
- Three LED fuel gauge system for immediate feedback on the state of charge
- Lightweight at 1.4 lbs and compatible with entire line of 20 V MAX tools
- No memory and virtually no self-discharge for maximum productivity and less downtime

C&M PART #	MFG PART #	DESCRIPTION
106649	DCB246CK	20 V MAX Starter Kit with XR 6.0 Ah and 4.0 Ah Lithium Ion Batteries
106635	DCB205-2CK	20 V MAX Starter Kit with two XR 5.0 Ah Lithium Ion Batteries

DeWALT® 20 V/60 V Power Station & Battery Charger



The DeWALT 20 V/60 V Power Station & Battery Charger is a convenient portable unit that provides AC power in remote locations. Power station/charger provides 1800 W (15 A) continuous power and 3600 W peak power to run most corded tools. Use it also as a multiport parallel charger for up to four DEWALT 20 V MAX batteries when plugged into a wall outlet via extension cord (batteries and extension cord sold separately). Compact and lightweight power station weighs just 18 lbs.

FEATURES & BENEFITS

- 1800 watt portable power station
- Four port parallel charger
- Runs on four 20 V MAX batteries (including FLEXVOLT), 15 amps out

C&M PART #	MFG PART #	DESCRIPTION
106648	DCB1800B	20 V/60 V Power Station & Battery Charger

DeWALT® 20 V MAX Cordless Tripod Light, Light Only



The DeWALT 20 V MAX Cordless Tripod Light illuminates your workspace in the toughest jobsite conditions. It is built for incredible durability in use, storage, and transport. Cutting edge LED technology provides extended runtime and natural white light while eliminating the hazardous heat of halogen. Variable brightness settings up to 3000 lumens let you customize illumination for your work area. Rotating, pivoting head make it easy to directs light where you need it. Compact design with carry handle provides easy portability and sets up in seconds. Battery and charger sold separately.



FEATURES & BENEFITS

- Natural white LED provides accurate color visibility, long life span and stays cool to the touch
- Three brightness settings (up to 3000 lumens) to customize workspace illumination
- Telescoping pole extends light head to 7 feet to reduce shadows and glare

C&M PART #	MFG PART #	DESCRIPTION
106671	DCL079B	20 V MAX Cordless Tripod Light, Light Only

DeWALT® 20 V MAX Brushless Cordless Reciprocating Saw with FLEXVOLT Advantage™, Tool Only

Take advantage of more power with the DEWALT 20 V MAX brushless tools with FLEXVOLT Advantage tool technology. The reciprocating saw has up to 50% more power when paired with a DCB606 60 V MAX FLEXVOLT® battery compared to a DCB205 DEWALT 20 V MAX battery. Battery and charger sold separately.

FEATURES & BENEFITS

- An 1-1/8" stroke length delivers a fast cutting speed
- Keyless lever-action blade clamp for quick and easy blade changes
- Variable-speed trigger with 0 to 3000 spm provides excellent blade control
- Bright LED for better visibility in low-light work areas



C&M PART #	MFG PART #	DESCRIPTION
106742	DCS386B	20 V MAX Brushless Cordless Reciprocating Saw with FLEXVOLT Advantage, Tool Only

REPLACEMENT PARTS & ACCESSORIES

C&M PART #	MFG PART #	DESCRIPTION
106639	DCB606-2	20 V/60 V MAX FLEXVOLT 6.0 Ah Battery, 2/Pack

DeWALT® 20 V MAX Cordless Tools

DeWALT 20 V MAX 1/4" 2-Speed & 3-Speed Impact Drivers, Tool Only

FEATURES & BENEFITS

- DeWalt built brushless motor and XR® Li-ion batteries deliver more run time and capacity over standard units
- Compact design—easily fits into tight areas
- Three LED lights with 20 second delay after trigger release, provide visibility without shadows
- One-handed loading 1/4" hex chuck accepts 1" bit tips



INCLUDES

Belt hook

C&M PART #	MFG PART #	DESCRIPTION
106665	DCF885B	20 V MAX Lithium Ion 2-Speed Impact Driver, 1/4", Tool Only
106666	DCF845B	20 V MAX Lithium Ion 3-Speed Impact Driver, 1/4", Tool Only
106637	DCB205-2	20 V MAX XR 5 Ah Battery, 2/Pack

DeWALT 20 V MAX 14G Swivel-Head Double Cut Shears, Tool Only

FEATURES & BENEFITS

- 360 degree swivel head allows easy access tight quarters while maintaining comfort
- A 7/32" strip continuously curls out of the cutting area providing consistent and accurate cuts
- LED light illuminates work area



INCLUDES

Hex wrench

C&M PART #	MFG PART #	DESCRIPTION
106762	DCS494B	20 V MAX 14 Gauge Swivel-Head Double Cut Shears, Tool Only
106637	DCB205-2	20 V MAX XR 5 Ah Battery, 2/Pack

DeWALT 20 V MAX 4-1/2 to 5" Brushless Cordless Paddle Switch Angle Grinder, Tool Only



FEATURES & BENEFITS

- The brushless motor delivers 1550 max watts out and up to 9000 rpm to handle tough jobs
- Kickback brake quickly stops the wheel when a bind-up occurs for added safety
- E-Clutch® feature shuts down the motor in under a tenth of a second when a pinch/stall is detected

INCLUDES

Side handle, 4-1/2" Type 27 guard, wrench, inner flange and outer flange

C&M PART #	MFG PART #	DESCRIPTION
106763	DCG416B	20 V MAX Brushless Cordless Paddle Switch Angle Grinder, 4-1/2 to 5", Tool Only
106637	DCB205-2	20 V MAX XR® 5 Ah Battery, 2/Pack

DeWALT 20 V MAX Cordless Reciprocating Saws, Tool Only



FEATURES & BENEFITS

- Four-position blade clamp allows for flush cutting and quick and easy blade changes
- Variable speed trigger and 1-1/8" stroke length deliver a faster cutting speed
- The pivoting shoe provides leverage during cutting and extends blade life
- Bright LED illuminates dark work areas for better visibility

C&M PART #	MFG PART #	DESCRIPTION
106668	DCS380B	20 V MAX Cordless Reciprocating Saw, Tool Only
106743	DCS387B	20 V MAX Compact Cordless Reciprocating Saw, Tool Only
106637	DCB205-2	20 V MAX XR 5Ah Battery, 2/Pack

Continued on Next Page

DeWALT® 20 V MAX Cordless Tools (continued)

DeWALT 20V MAX 6-1/2" Circular Saw, Tool Only

FEATURES & BENEFITS

- 5150 rpm motor delivers power and speed to make the most demanding cuts with ease
- High strength and lightweight magnesium shoe provides durability for long-term cut accuracy
- 0 to 50 degree bevel capacity allows for aggressive bevel cuts for a multitude of applications



INCLUDES

6-1/2" carbide-tipped blade

C&M PART #	MFG PART #	DESCRIPTION
106653	DCS391B	20 V MAX Circular Saw, 6-1/2", Tool Only
106637	DCB205-2	20 V MAX XR® 5 Ah Battery, 2/Pack

DeWALT 20 V MAX Bandsaw, Tool Only

FEATURES & BENEFITS

- 2-1/2" cut capacity cuts up to 2" SCH 40 pipe
- Centered handle position provides superior balance, more accurate cuts and less user fatigue
- LED work light with 20-second delay illuminates dark work surfaces for accurate cutting
- Dual-bearing blade guide rollers provides increased durability in the blade support system
- Ergonomic soft grip back handle provides comfort and flexibility



INCLUDES

14/18 TPI blade and blade tracking wrench

C&M PART #	MFG PART #	DESCRIPTION
106634	DCS371B	20 V MAX Bandsaw, Tool Only
106637	DCB205-2	20 V MAX XR® 5 Ah Battery, 2/Pack

DeWALT 20V MAX 4-1/2" Circular Saw, Tool Only



FEATURES & BENEFITS

- Brushless motor cuts up to 339 linear feet of 3/4" OSB using DCB205 battery (sold separately)
- Removable auxiliary handle for increased control
- A bevel gear design allows users to cut 2x material at 90 degrees and 1x material at 45 degrees

INCLUDES

Wood cutting blade, blade change key, dust port adapter and rip fence

C&M PART #	MFG PART #	DESCRIPTION
106655	DCS571B	20 V MAX Cordless Circular Saw, 4-1/2", Tool Only
106637	DCB205-2	20 V MAX XR® 5 Ah Battery, 2/Pack

DeWALT 20 V MAX Cordless LED Work Light, Light Only

FEATURES & BENEFITS

- Bright LED output of 160 lumens shines bright
- Integral hook for hands free use in multiple placements
- Head tilts 120 degrees so you can shine it where you need it



C&M PART #	MFG PART #	DESCRIPTION
106670	DCL040	20 V MAX Cordless LED Work Light, Light Only
106637	DCB205-2	20 V MAX XR® 5 Ah Battery, 2/Pack

DeWALT® 20 V MAX 7-1/4" Brushless Cordless Circular Saw with FLEXVOLT Advantage™, Tool Only

Get more power from DEWALT 20 V MAX brushless tools with FLEXVOLT Advantage tool technology. The 7-1/4" circular saw has up to 77% more power when paired with a DCB606 FLEXVOLT® battery compared to a DCB205 20 V MAX battery. Battery and charger sold separately.



FEATURES & BENEFITS

- Powerful brushless motor delivers 5500 rpm for faster cutting
- Maximum depth of cut of 2-9/16" at 90 degrees; 2" at 45 degrees
- Electric brake stops the blade after the trigger is released
- Bright LED increases visibility helping with cut accuracy

C&M PART #	MFG PART #	DESCRIPTION
106656	DCS573B	20 V MAX Brushless Cordless Circular Saw with FLEXVOLT Advantage, 7-1/4", Tool Only

REPLACEMENT PARTS & ACCESSORIES

C&M PART #	MFG PART #	DESCRIPTION
106639	DCB606-2	20 V/60 V MAX FLEXVOLT 6.0 Ah Battery, 2/Pack

INCLUDES

DWA171424 saw blade and blade change wrench

DeWALT® 20V MAX Brushless Cordless SDS Plus D-Handle Rotary Hammer



The 20V MAX Brushless Cordless SDS PLUS D-Handle 1" Rotary Hammer is compact and lightweight yet delivers 2.6 joules of impact energy for fast drilling. Small size allows access to confined spaces while lightweight design minimizes user fatigue. Optimize performance in a wide range of jobs with a rotating dial that can be set to drill, hammer drill, or chip mode. The mechanical clutch enhances user control in a bind up situation and can help minimize sudden torque reaction.

FEATURES & BENEFITS

- Optimized 2.6J mechanism provides faster than corded speed of application
- Maintains speed through the entire application without bogging down even with the largest bits
- Compact size allows access to space restricted areas

INCLUDES

360-degree side handle and depth rod

C&M PART #	MFG PART #	DESCRIPTION
106758	DCH133B	20V MAX Brushless Cordless SDS PLUS D-Handle 1" Rotary Hammer, Tool Only

REPLACEMENT PARTS & ACCESSORIES

C&M PART #	MFG PART #	DESCRIPTION
106637	DCB205-2	20V MAX XR® 5 Ah Battery, 2/Pack

DeWALT® 20V MAX Brushless Cordless SDS Plus L-Handle Rotary Hammer

The 20V MAX Brushless Cordless SDS PLUS L-Handle 1" Rotary Hammer is lightweight yet delivers 2.1 joules of impact energy for fast drilling. Use the rotary hammer for complete rod hanging, seismic and safety attachments, cable tray and strut mounting, clamp mounting



and rail mounting applications. Lightweight design minimizes user fatigue even during prolonged use. The Shocks Active Vibration Control® feature reduces vibration felt by the user at the handles. Order battery and charger separately.

FEATURES & BENEFITS

- Brushless motor for extended runtime and durability
- Shocks active vibration control significantly reduces vibration and increases user comfort and productivity
- 2.1 Joules impact energy provides corded power without the cord
- Rotating dial to set tool to a specific application mode—drill, hammer drill or chip

INCLUDES

360-degree side handle, depth rod and adjustable hook

C&M PART #	MFG PART #	DESCRIPTION
106759	DCH273B	20V MAX Brushless Cordless SDS PLUS L-Shape 1" Rotary Hammer, Tool Only

REPLACEMENT PARTS & ACCESSORIES

C&M PART #	MFG PART #	DESCRIPTION
106637	DCB205-2	20V MAX XR® 5 Ah Battery, 2/Pack

DeWALT® 20V MAX Brushless Cordless SDS Plus L-Handle Rotary Hammer Kit

The 20V MAX Brushless Cordless SDS PLUS L-Handle 1" Rotary Hammer is lightweight yet delivers 2.1 joules of impact energy for fast drilling. Use the rotary hammer for complete rod hanging, seismic and safety attachments, cable tray and strut mounting, clamp mounting and rail mounting applications. Lightweight design minimizes user fatigue even during prolonged use. The Shocks Active Vibration Control® feature reduces vibration felt by the user at the handles. Use rotary hammer with included onboard dust extractor to remove 99.97% of airborne particles 0.3 microns or greater.



FEATURES & BENEFITS

- Brushless motor for extended runtime and durability
- Shocks active vibration control significantly reduces vibration and increases user comfort and productivity
- 2.1 Joules impact energy provides corded power without the cord
- Rotating dial to set tool to a specific application mode—drill, hammer drill or chip
- OSHA Table 1-compliant dust extractor ensures worker safety

INCLUDES

DCH273 rotary hammer, 360-degree side handle, two 20V MAX XR 5 Ah batteries (DCB205), charger, depth rod, adjustable hook, dust extractor (DWH303DH) and kit box

C&M PART #	MFG PART #	DESCRIPTION
106760	DCD985M2	20V MAX Brushless SDS PLUS L-Shape 1" Rotary Hammer Kit

DeWALT® 20V MAX Cordless Three-Speed Hammer Drill Kit

The 20V MAX Hammer Drill powered by XR® premium lithium-ion battery offers long tool runtime and excellent durability. High-power, high-efficiency motor delivers 535-unit watts out of max power for superior performance in all drilling and fastening applications. Select from three speeds to match your drilling needs. Heavy-duty 1/2" metal ratcheting chuck with carbide inserts provides superior bit gripping strength. An LED work light with 20-second delay illuminates dark work surfaces for accurate drilling.



FEATURES & BENEFITS

- High-power, high-efficiency motor meets most drilling needs
- Three-speed selection
- Heavy-duty metal ratcheting chuck offer excellent gripping strength
- LED light with 20-second delay after trigger release

INCLUDES

DCD985B hammer drill, 360-degree side handle, two 20V MAX XR® 4 Ah batteries (DCB204), charger, depth rod and adjustable hook and kit box

C&M PART #	MFG PART #	DESCRIPTION
106663	DCD996P2	20V MAX Hammer Drill Kit

DeWALT® Atomic™ 20V MAX Cordless Impact Wrench Kit

The Atomic 20V MAX 1/2" Cordless Impact Wrench was designed easily to handle various fastening projects. This compact power tool offers easy maneuverability without sacrificing power—get up to 300 ft-lbs of fastening torque and 450 ft-lbs of breakaway torque. Choose between four speed settings including Precision Wrench™ control feature and Timber Screw™ mode to allow for reliable high-level performance, operability, and versatility. A convenient LED provides light for visibility in dimly lit spaces.



FEATURES & BENEFITS

- Compact and lightweight—measures only 5.70" and weighs 3.4 lbs—easily fits into tight areas
- Brighten dark work areas with onboard LED and brightness control
- Glass-filled nylon housing provides resistance from damage caused by some oils and solvents
- Hog ring anvil for rapid, secure socket changes
- Enhanced user control in a variety of applications with four speed settings
- Three-LED battery fuel gauge indicator displays battery life

INCLUDES

DCF921 impact wrench, two 20V MAX XR® 5 Ah Batteries (DCB205), charger, belt clip and kit bag

C&M PART #	MFG PART #	DESCRIPTION
106667	DCF921P2	Atomic 20V MAX 1/2" Impact Wrench Kit

DeWALT® Atomic™ 20V MAX Brushless Cordless Three-Speed Impact Driver Kit

The Atomic 20V MAX 1/4" Brushless Cordless Three-Speed Impact Driver can handle tough jobs in tight spaces such as narrow cabinetry or framing without the need for an additional tool. Though lightweight and compact in size, the impact driver does not sacrifice performance with its brushless motor that delivers up to 1825 in-lb of torque and 3250 rpm for driving large-diameter screws. The three-LED on-board work light illuminate dim workspaces for enhanced visibility and help keep your workflow consistent.



FEATURES & BENEFITS

- Compact design—under 4" front to back for optimized ergonomics and access to difficult-to-reach spots
- Pro-level control and precision with a variable three-speed trigger
- Integrated three-LED work light enhances visibility in dimly lit spaces

INCLUDES

DCF850 impact driver, 20V MAX XR® 5.0 Ah battery (DCB205), charger, belt hook and kit bag

C&M PART #	MFG PART #	DESCRIPTION
106714	DCF850P1	Atomic 20V MAX Brushless Cordless 1/4" Three-Speed Impact Driver Kit

DeWALT® Atomic™ 20V MAX Brushless Cordless Compact Drill/Driver Kit

The Atomic 20V MAX Compact Brushless Drill/Driver provides power in a compact size. This drill/driver measures only 6.3" front to back and weighs only 2.8 lbs, but delivers 340 unit watts outs (UWO) to satisfy a variety of drilling applications. The 1/2" ratcheting chuck provides superior built gripping strength. For increased comfort, the handle features an ergonomic design for balance and easier tool control along with a removable belt hook. Use the LED light to provide optimum illumination in dark spaces as you work.



FEATURES & BENEFITS

- Compact size—measures only 6.3" front to back—easily fits into tight spaces
- Lightweight at only 2.8 lbs minimizes user fatigue
- Brushless motor for efficient performance and runtime
- LED foot light for superior visibility
- Variable-speed trigger allows for control and precision on delicate work surfaces

INCLUDES

DCD708 drill/driver, two 20V MAX lithium ion 1.5 Ah batteries (DCB201), charger, belt clip and kit bag

C&M PART #	MFG PART #	DESCRIPTION
106685	DCD708C2	Atomic 20V MAX Brushless Compact 1/2" Drill/Driver Kit

DeWALT® 20V MAX Cordless Band Saw Kit



The 20V MAX Cordless lithium-ion band saw features a 2-1/2" cut capacity, capable of cutting up to 2" SCH 40 pipe. A centered handle position provides superior balance and ergonomics, allowing more accurate cuts and less user fatigue. An LED work light with 20-second delay illuminates dark work surfaces for accurate cutting. Use the integrated hang hook to hang the saw without damaging the front handle or base. A blade tracking adjustment increases blade life while dual bearing blade guide rollers provide increased durability in the blade support system.

FEATURES & BENEFITS

- Lightweight at only 3.4 lbs
- Textured anti-slip comfort grip provides maximum comfort and control
- Three LED battery fuel gauge indicator displays battery life

INCLUDES

DCS371 band saw, 20V MAX XR premium 5 Ah Li-ion battery (DCB205), fast charger, 14/18 tpi blade, blade tracking wrench and kit bag

SPECIFICATIONS

CUTTING SPEED	570 spm
MAX CUTTING (ROUND)	2.5"
MAX CUTTING (SQUARE)	2.5"
BLADE LENGTH	32-7/8" and band saw dimensions

C&M PART #	MFG PART #	DESCRIPTION
106650	DCS371P1	20V MAX Band Saw Kit

DeWALT® FLEXVOLT 60V MAX Brushless Cordless Reciprocating Saw Kit



One of DeWALT most powerful tools just got better with the DCS389 60V MAX Reciprocating Saw. It provides up to 19% more power than the DCS388 60V MAX reciprocating saw with 1874-unit watts out. Through the revolutionary FLEXVOLT® technology, this reciprocating saw delivers a no-load speed of 3000 spm, combining the power of a corded reciprocating saw with the portability and convenience of a cordless. Use the built-in LED to illuminate dimly lit work areas for enhanced visibility and help keep your workflow consistent.

FEATURES & BENEFITS

- Power of corded with the freedom of cordless
- 0 - 3000 spm and 1-1/8" stroke length for fast and efficient cutting
- Keyless lever-action blade clamp for quick and easy blade changes

INCLUDES

DCS389 60V MAX reciprocating saw, FLEXVOLT 9 Ah battery (DCB609), charger, blade and kit bag

C&M PART #	MFG PART #	DESCRIPTION
106669	DCS389X1	FLEXVOLT 60V MAX Brushless Reciprocating Saw Kit

REPLACEMENT PARTS & ACCESSORIES

C&M PART #	MFG PART #	DESCRIPTION
106643	DCB609-2	FLEXVOLT 20V/60V MAX 9 Ah Battery, 2/Pack

DeWALT® FLEXVOLT 60V MAX Cordless Grinder Kit



The FLEXVOLT® 60V MAX Grinder provides up to 30% more power than the DCG414 60V MAX cordless grinder to add even more power to our line of powerful grinder tools. The grinder delivers 13 amp power with a no-load speed of 9000 rpm to power through tough job. As part of our Perform & Protect™ product line, safety features include the Kickback Brake™ and the anti-rotation E-Clutch® system that are designed to help keep users safe by shutting the grinder off in the event of a pinch, stall or bind up.

FEATURES & BENEFITS

- Power through tough jobs with 13-amp motor
- 9000 rpm no-load speed for applications with 6" grinder wheels
- E-Clutch® system activates in less than a tenth of a second when a pinch/stall is detected, shutting down the motor
- Kickback Brake engages when a pinch, stall, or bind-up event is sensed and shut the grinder off

INCLUDES

DCG418 grinder, FLEXVOLT 9 Ah battery (DCB609), charger, side handle, 4-1/2" (115 mm) type 27 guard, 6" (150 mm) type 27 guard, wrench, two flanges and kit bag

C&M PART #	MFG PART #	DESCRIPTION
106662	DCG418X1	FLEXVOLT 60V MAX Grinder Kit

REPLACEMENT PARTS & ACCESSORIES

C&M PART #	MFG PART #	DESCRIPTION
106643	DCB609-2	FLEXVOLT 20V/60V MAX 9 Ah Battery, 2/Pack

DeWALT® FLEXVOLT 60V MAX Cordless Circular Saw with Brake Kit

One of DeWALT most powerful tools just got better with the 60V MAX 7-1/4" Circular Saw with electric brake. The electric brake immediately stops the blade once the trigger is released ensuring worker safety. This saw has up to 47% more power than the DCS575 60V MAX circular saw with 2456-unit watts out. Through the revolutionary FLEXVOLT® technology, this circular saw delivers a no-load speed of 5800 rpm, combining the power of a corded circular saw with the portability and convenience of a cordless. Use the integrated LED for increased visibility and cut accuracy.

FEATURES & BENEFITS

- Uses a 7-1/4" circular saw blade and features a maximum cut depth of 2-9/16" at a 90 degree bevel.
- Maximum bevel capacity of 57 degrees with bevel stops at 22.5 degrees and 45 degrees
- Electric brake stops the blade after the trigger is released

INCLUDES

DCS578 circular saw, FLEXVOLT 9 Ah battery (DBC609), charger, blade, blade wrench and kit bag



C&M PART #	MFG PART #	DESCRIPTION
106654	DCS578X1	FLEXVOLT 60V MAX Circular Saw with Brake Kit

REPLACEMENT PARTS & ACCESSORIES

C&M PART #	MFG PART #	DESCRIPTION
106643	DCB609-2	FLEXVOLT 20V/60V MAX 9 Ah Battery, 2/Pack

DeWALT® 20V MAX XR® Cordless Series Tools

Build out your Tool Kit with DeWalt 20V MAX XR bare power tools. DeWalt MAX XR batteries are sold separately.

20V MAX XR Brushless Compact Drill/Driver

FEATURES & BENEFITS

- Brushless motor delivers up to 57% more run time over brushed
- High-speed transmission with two-speed settings (0 to 550 and 0 to 2000 rpm) delivers up to 30% faster application speeds



INCLUDES

Belt Hook

C&M PART #	MFG PART #	DESCRIPTION
106658	DCD791B	20V MAX XR Brushless Compact Drill/Driver, Tool Only
106637	DCB205-2	20V MAX XR 5 Ah Battery, 2/Pack

DeWALT® 20V MAX XR 1/2" High-Torque Brushless Impact Wrench with Detent Pin Anvil or Hog Ring Anvil

FEATURES & BENEFITS

- Provides up to 700 ft-lbs of max torque and 1200 ft-lbs of max breakaway torque with 20V MAX XR 5 Ah battery
- Compact design of 8-13/16" in length and weighs only 6 lbs
- Multi-speed control for a variety of applications (0 to 400, 1200 and 1900 rpm)



C&M PART #	MFG PART #	DESCRIPTION
106718	DCF899B	20V MAX XR 1/2" High-Torque Impact Wrench with Detent Pin Anvil, Tool Only
106719	DCF899HB	20V MAX XR 1/2" High-Torque Impact Wrench with Hog Ring Anvil, Tool Only
106637	DCB205-2	20V MAX XR 5 Ah Battery, 2/Pack

DeWALT® 20V MAX XR 1/2" Mid-Range Impact Wrench with Detent Pin Anvil

FEATURES & BENEFITS

- Provides up to 330 ft-lbs max fastening torque
- Lightweight—only weighs 3.48-lbs—to minimize user fatigue
- Three mode settings to complete a variety of applications



C&M PART #	MFG PART #	DESCRIPTION
106717	DCF894B	20V MAX XR 1/2" Mid-Range Impact Wrench with Detent Pin Anvil, Tool Only
106637	DCB205-2	20V MAX XR 5 Ah Battery, 2/Pack

DeWALT® 20V MAX XR Brushless Jig Saw

FEATURES & BENEFITS

- Compact size for easy grip and maximum control
- Integrated dust blower helps clear line of sight while cutting
- Variable-speed trigger and dial provide precise speed control



INCLUDES

Jig saw blade

C&M PART #	MFG PART #	DESCRIPTION
106720	DCS334B	20V MAX XR Brushless Jig Saw, Tool Only
106637	DCB205-2	20V MAX XR 5 Ah Battery, 2/Pack

DeWALT® 20V MAX XR Brushless Deep Cut Band Saw

FEATURES & BENEFITS

- Cuts up to 5" x 4-3/4" rectangular materials and up to 4" round materials
- Variable-speed trigger and dial allow for versatility and control
- Integrated hang hook allows user to hang the saw without damaging the front handle or base



C&M PART #	MFG PART #	DESCRIPTION
106651	DCS374B	20V MAX XR Brushless Deep Cut Band Saw, Tool Only
106637	DCB205-2	20V MAX XR 5 Ah Battery, 2/Pack

DeWALT® 20V MAX XR® Cordless Series Tools

DeWALT® 20V MAX XR Brushless Compact Reciprocating Saw



FEATURES & BENEFITS

- 0 to 2900 spm and 1-1/8" stroke length provide fast and efficient cutting
- A keyless, lever-action four-position blade clamp offers quick and easy blade changes
- Variable-speed trigger provides instant speed control to match the speed to the application

INCLUDES

Jig saw blade

C&M PART #	MFG PART #	DESCRIPTION
106741	DCS367B	20V MAX XR Brushless Compact Reciprocating Saw, Tool Only
106637	DCB205-2	20V MAX XR 5 Ah Battery, 2/Pack

DeWALT® 20V MAX XR Brushless Small Angle Grinder with Kickback Brake™



FEATURES & BENEFITS

- Brake stops wheel on average in 2 seconds or less
- Kickback Brake engages when a pinch, stall, or bind-up event is sensed to quickly stop the wheel

INCLUDES

Side handle, hex key, inner and outer flange and 4.5" type 27 guard

C&M PART #	MFG PART #	DESCRIPTION
106660	DCG413B	20V MAX XR Small Angle Grinder, Tool Only
106637	DCB205-2	DeWALT 20V MAX XR 5 Ah Battery, 2/Pack

DeWALT® FLEXVOLT® 60V MAX Brushless Cordless Cut-Off Saw Kit



The FLEXVOLT Brushless Cut-Off Saw features a high-performance brushless motor that provides up to 6500 rpm with instant-on functionality. A brushless all-metal drivetrain makes this saw durable and efficient. Make fast and efficient single pass cuts up to 3-1/4" deep or scores in concrete, pave stones, steel, and rebar. A rotatable 5-position guard allows selection of approach angle for optimal visibility and accessibility when cutting in tight spaces. The dual-sided water feed system offers an OSHA table 1 compliant solution for dust management when cutting concrete and masonry materials.

FEATURES & BENEFITS

- Heavy load indicator light provides power and runtime feedback during demanding applications
- Hold the front handle in three different positions for a secure hold
- Cut in both horizontal and vertical positions
- Latched and sealed battery box for added protection in harsh jobsite conditions

INCLUDES

DCS690 cut-off saw, two FLEXVOLT 20V/60V 9 Ah batteries (DCB609), cutting wheel, diamond cutting wheel and fast charge

C&M PART #	MFG PART #	DESCRIPTION
106657	DCS690X2	FLEXVOLT 60V MAX 9" Brushless Cordless Cut-Off Saw Kit

REPLACEMENT PARTS & ACCESSORIES

C&M PART #	MFG PART #	DESCRIPTION
106643	DCB609-2	FLEXVOLT 20V/60V MAX 9 Ah Battery, 2/Pack

DON'T FORGET SAW BLADES

See our selection on **page 452**.



DeWALT® 20V MAX XR® High-Torque Brushless Cordless Impact Wrench with Detent Pin Anvil Kit



Use the powerful and versatile 20V MAX XR 1/2" High-Torque Impact Wrench with Detent Anvil for various fastening applications. Brushless motor provides efficient performance and run time. Designed for user comfort, the impact wrench measures 8-13/16" in length and weighs only 6 lbs. An LED light with 20-second delay helps to illuminate poorly lit areas.

FEATURES & BENEFITS

- Up to 700 ft-lbs of max torque and 1200 ft-lbs of max breakaway torque
- Compact design of 8-13/16" in length and weighs only 6 lbs
- Multi-speed control for a variety of applications (0 to 400, 1200 and 1900 rpm)
- 1/2" anvil with detent pin

INCLUDES

DCF889 impact wrench with detent pin anvil, two 20V MAX XR 5 Ah batteries (DCB205), charger and kit bag

C&M PART #	MFG PART #	DESCRIPTION
106716	DCF899P2	20V MAX XR 1/2" High-Torque Impact Wrench with Detent Pin Anvil Kit

REPLACEMENT PARTS & ACCESSORIES

C&M PART #	MFG PART #	DESCRIPTION
106637	DCB205-2	20V MAX XR 5 Ah Battery, 2/Pack

DeWALT® 20V MAX XR® Brushless Cordless Three-Speed Hammer Drill Kit



The 20V MAX XR Cordless 1/2" Hammer Drill/Driver features a high-power, high-efficiency brushless motor that delivers up to 75% more runtime than 18V NiCd brushed motors. The three-speed, all-metal high-performance transmission optimizes tool-to-task for fast application speeds and improved run-time. The drill/driver comes equipped with a heavy-duty ratcheting nitro-carburized metal chuck with carbide inserts for superior bit gripping strength. A three-mode LED is 20x brighter than the previous model to illuminate dark or confined spaces.

FEATURES & BENEFITS

- Heavy-duty ratcheting nitro-carburized metal chuck with carbide inserts provides exceptional bit grip strength
- XR Li-Ion batteries with fuel gauge provide 33% more capacity over standard packs
- Ultra bright LED illuminates work areas

INCLUDES

DCD996 hammer drill/driver, two 20V MAX XR 5 Ah batteries (DCB205), charger, belt hook, 360-degree side handle and kit box

C&M PART #	MFG PART #	DESCRIPTION
106664	DCD996P2	20V MAX XR Brushless Hammer Drill/Driver Kit

REPLACEMENT PARTS & ACCESSORIES

C&M PART #	MFG PART #	DESCRIPTION
106637	DCB205-2	20V MAX XR 5 Ah Battery, 2/Pack

DeWALT® 20V MAX XR® Brushless Cordless Three-Speed Drill/Driver Kit

The 20V MAX XR Brushless-Speed Drill/Driver features a high-efficiency brushless motor that delivers up to 57% more runtime over brushed hammer drill/driver. The high-performance, three-speed, all-metal high-performance transmission optimizes tool-to-task for fast application speeds and improved run-time. Use the LED spotlight with 20-minute auto-shutoff to boost productivity in dark spaces.

FEATURES & BENEFITS

- Heavy-duty ratcheting nitro-carburized metal chuck with carbide inserts provides exceptional bit grip strength
- XR Li-ion batteries with fuel gauge provide 33% more capacity over standard packs
- Three-mode LED is 20x brighter than the previous model to illuminate dark or confined spaces

INCLUDES

DCD991 drill/driver, two 20V MAX XR 5 Ah batteries (DCB205), charger, belt hook, 360-degree side handle and kit box



C&M PART #	MFG PART #	DESCRIPTION
106659	DCD991P2	20V MAX XR Brushless Three-Speed Drill/Driver Kit

REPLACEMENT PARTS & ACCESSORIES

C&M PART #	MFG PART #	DESCRIPTION
106637	DCB205-2	20V MAX XR 5 Ah Battery, 2/Pack

DeWALT® 20V MAX XR® Brushless Cordless Three-Speed Impact Driver Kit



The 20V MAX XR 1/4" Impact Driver features a brushless motor and uses XR lithium-Ion batteries to deliver more run time and capacity over standard units. Select from three-speed settings to optimize application versatility. With its compact and lightweight design, this impact driver easily fits into tight work areas. Simple one-handed loading 1/4" hex chuck with grip sleeve accepts 1" bit tips.

FEATURES & BENEFITS

- Three-speed settings for optimized application versatility
- Precision drive in speed 1 for precision applications and added control
- Lightweight driver minimizes user fatigue
- 3 LED lights with 20-second delay after trigger release, provide visibility without shadows

INCLUDES

DCF887 impact driver, two 20V MAX XR 4 Ah batteries, fast charger, belt hook and kit box

C&M PART #	MFG PART #	DESCRIPTION
106715	DCF887M2	20V MAX XR 1/4" Three-Speed Impact Driver Kit

REPLACEMENT PARTS & ACCESSORIES

C&M PART #	MFG PART #	DESCRIPTION
106636	DCB204-2	20V MAX XR 4 Ah Battery, 2/Pack

DeWALT® 20V MAX XR® Brushless Cordless Deep Cut Band Saw Kit



The 20V MAX XR Brushless Deep Cut Band Saw cuts up to 5" x 4-3/4" rectangular materials and up to 4" round materials. Easily cut through unistrut, conduit, angle iron, SCH 40 pipe and various other materials. This deep cut band saw is capable of up to 149 cuts of 1-5/8" strut with 14 TPI blade. Use the LED work light with a 20-second delay to illuminate dark work surfaces for accurate cutting. The integrated hang hook allows the saw to hang without damaging the front handle or base. Simply push the blade changing lever to loosen blade tension for easy blade changes.

FEATURES & BENEFITS

- Cuts up to 5" x 4-3/4" rectangular materials and up to 4" round materials
- Variable-speed trigger and dial allow for versatility and control
- Fast and easy tool-less blade changes
- Integrated hang hook allows user to hang the saw without damaging the front handle or base
- LED work light with 20-second delay illuminates dark work surfaces for accurate cutting

INCLUDES

DCS374 band saw, two 20 V MAX XR 5 Ah batteries (DCB205), charger, 18TPI band saw blade and kit box

C&M PART #	MFG PART #	DESCRIPTION
106652	DCS374P2	20V MAX XR Brushless Deep Cut Band Saw Kit

REPLACEMENT PARTS & ACCESSORIES

C&M PART #	MFG PART #	DESCRIPTION
106637	DCB205-2	20V MAX XR 5 Ah Battery, 2/Pack

DeWALT® 20V MAX XR® Grinder with Brake Kit

The 20V MAX XR 4-1/2" Small Angle Grinder features Kickback Brake™ function that is designed to help keep users safe by shutting the grinder off in the event of a pinch, stall or bind up. The brushless motor extends motor life and eliminates any need for brush changes.

FEATURES & BENEFITS

- Brushless motor requires no brush changes
- Brake stops wheel on average in 2 seconds or less
- Two stage trigger requires two actions to activate tool

INCLUDES

DCG413 small angle grinder, two 20V MAX XR® 6 Ah batteries (DCB206), charger (DCB115), side handle, hex key, inner and outer flange, 4.5" type 27 guard and Kit bag



C&M PART #	MFG PART #	DESCRIPTION
106661	DCG413R2	20V MAX XR Grinder Kit

REPLACEMENT PARTS & ACCESSORIES

C&M PART #	MFG PART #	DESCRIPTION
106638	DCB206-2	20V MAX XR 6 Ah Battery, 2/Pack

DeWALT® Atomic™ 20V MAX Brushless Cordless Drill/Driver & Impact Driver Combo Kit



Get two compact and powerful cordless tools—a 1/2" Drill/Driver and a 1/4" Impact Driver—in one convenient kit. Both tools operate on 20V 5 Ah Li-ion battery to deliver high performance and run time. Ergonomic design of the tools minimizes worker fatigue while ensuring safety.

The **DCD708 1/2" Drill/Driver** provides power in a compact size. This drill/driver measures only 6.3" front to back and weighs only 2.8 lbs, but delivers 340-unit watts outs (UWO) to satisfy a variety of drilling applications. The 1/2" ratcheting chuck provides superior built gripping strength. Use the LED light to provide optimum illumination in dark spaces as you work.

The **DCF809 1/4" Impact Driver** only measures 5.1" from front to back—ideal for working in tight spaces. It features a high-performance brushless motor that delivers 1700 in-lbs of torque that meets the needs of many tough applications. Use the three LED lights to provide optimum illumination in dark spaces as you work.

FEATURES & BENEFITS

- Variable-speed trigger allows for control and precision on delicate work surfaces
- Brushless motor provides efficient performance and run time
- Ergonomic design ensures worker safety and minimize user fatigue

INCLUDES

DCD708 1/2" drill/driver, DCF809 1/4" impact driver, two 20V MAX 1.3 Ah batteries, charger, two belt clips and kit bag

C&M PART #	MFG PART #	DESCRIPTION
106675	DCK278C2	Atomic 20V MAX Brushless Cordless Drill/Driver & Impact Driver Combo Kit

REPLACEMENT PARTS & ACCESSORIES

C&M PART #	MFG PART #	DESCRIPTION
106637	DCB205-2	DeWALT® 20V MAX XR 5Ah Battery, 2/Pack

DeWALT® 20V MAX Brushless Cordless Hammer Drill/Driver & Impact Driver Combo Kit



Get two 20V MAX tools—a 1/2" Hammer Drill/Driver and a 1/4" Impact Driver—featuring FLEXVOLT ADVANTAGE™ technology in one convenient kit. When FLEXVOLT® batteries are installed, these tools deliver more power than when standard 20V MAX batteries are used, making them ideal for many tough applications. The included fast charger DCB118 works with both 20V MAX batteries and FLEXVOLT 20V/60V MAX batteries. Order FLEXVOLT batteries separately.

The **DCD999B 1/2" Hammer Drill/Driver** with FLEXVOLT ADVANTAGE technology gets up to 42% more power when paired with FLEXVOLT batteries. An LED spotlight with 20-minute shutoff function allows for extended work time in dark or confined spaces. This drill/driver accepts a Tool Connect™ chip for easy asset management on the job site.

The **DCF887 1/4" Impact Driver** features three-speed settings for added control. With its compact and lightweight design, this impact driver easily fits into tight work areas. Simple one-handed loading 1/4" hex chuck with grip sleeve accepts 1" bit tips. Three LEDs with 20-second delay after trigger release provide visibility without shadows.

FEATURES & BENEFITS

- Both tools compatible with all DeWALT 20V MAX and FLEXVOLT batteries
- Two powerful drivers in one convenient kit

INCLUDES

DCD999B hammer drill/driver, DCF887 impact driver, two 20V MAX 5 Ah battery (DCB205), 8 amp fast charger (DCB118), two belt hooks and kit bag

C&M PART #	MFG PART #	DESCRIPTION
106674	DCK2100P2	20V MAX Brushless Cordless Hammer Drill/Driver & Impact Driver Combo Kit

REPLACEMENT PARTS & ACCESSORIES

C&M PART #	MFG PART #	DESCRIPTION
106637	DCB205-2	20V MAX XR® 5 Ah Battery, 2/Pack

DeWALT® 20V MAX Brushless Cordless Drill/Driver, Impact Driver & Oscillating Multi-Tool Combo Kit



This 20V MAX three-tool combo kit includes 1/2" Drill/Driver, 1/4" Impact Driver and Oscillating Multi-Tool plus a charger and batteries in one convenient kit bag. All three tools feature a brushless motor that provides high performance and long service life.

The **DCD777 1/2-in Drill/Driver** with a high-performance motor delivers up to 340-unit watts out (UWO) of power. It only measures 7.52" front to back to easily fit into tight spaces.

The **DCF787 1/4" Impact Driver** only weighs 2 lbs yet delivers 1500 in-lbs of torque to tackle many tough jobs. It features an LED light with 20-second delay for better visibility in dimly lit areas.

The **DCS356 Oscillating Multi-Tool** is equipped with a three-speed selector allowing users to choose their speed setting based on application.

FEATURES & BENEFITS

- Compact and lightweight tools minimize user fatigue
- Three tools and accessories in one convenient tool bag
- Bright LED to illuminate dark work surfaces

INCLUDES

DCD777 drill/driver, DCF787 impact driver, DCS356 oscillating multi-tool, two 20V MAX 2 Ah batteries, charger (DCB107) and kit bag

C&M PART #	MFG PART #	DESCRIPTION
106678	DCK379D2	20V MAX Brushless Cordless Drill/Driver, Impact Driver & Oscillating Multi-Tool Combo Kit

REPLACEMENT PARTS & ACCESSORIES

C&M PART #	MFG PART #	DESCRIPTION
106637	DCB205-2	20V MAX XR 5Ah Battery, 2/Pack

DeWALT® 20V MAX XR® Brushless Cordless Six-Tool Combo Kit



The Ultimate Cordless Six-Tool Combo Kit has everything you need to get your job done. The included 20V MAX XR® power tools—hammer drill/driver, impact driver, circular saw, reciprocating saw and angle grinder—feature brushless motor that offer high performance and long service life.

The **DCD996 1/2" Hammer Drill/Driver** with three-speed transmission and high-power, high-efficiency brushless motor delivers up to 75% more run time than 18V NiCd brushed motors. Heavy-duty 1/2" ratcheting nitro-carburized metal chuck with carbide chuck provides superior grip strength.

The **DCF887 1/4" Impact Driver** features three-speed settings for optimized application versatility. Compact and lightweight design makes it ideal for use in tight areas. Simple one-handed loading 1/4" hex chuck with grip sleeve accepts 1" bit tips. Use the three LEDs with 20 second delay after trigger release for better visibility.

The **DCS570 7-1/4" Circular Saw** provides 5200 rpm maintaining speed under load. The 7-1/4" blade provides 2-9/16" cutting capacity at 90 degrees. It offers bevel capacity up to 57 degrees for increased versatility.

The **DCS367 Reciprocating Saw** is compact and lightweight to help make your jobs easier. With a 1-1/8" stroke length and a variable-speed trigger delivering up to 2900 strokes/minute, this saw is fast and efficient. A keyless, lever-action four-position blade clamp offers quick and easy blade changes.

The **DCG413 4-1/2" Angle Grinder** has a paddle switch release, engaging the brake quickly to bring the wheel to a stop ensuring worker safety.

The **DCL040 LED Work Light** provides 160 lumens to illuminates your work area. Head rotates 120 degrees to easily shine it where you need it. Use the integral hook for hands-free application.

INCLUDES

DCD996 hammer drill/driver, DCF887 impact driver, DCS570 circular saw, DCS367 reciprocating saw, DCG413 angle grinder, DCL040 LED work light, two 20V MAX XR 5 Ah batteries, charger (DCB115) and kit bag

C&M PART #	MFG PART #	DESCRIPTION
106679	DCK695P2	20V MAX XR Brushless Cordless Six-Tool Combo Kit

REPLACEMENT PARTS & ACCESSORIES

C&M PART #	MFG PART #	DESCRIPTION
106637	DCB205-2	20V MAX XR 5 Ah Battery, 2/Pack

DeWALT® 20V MAX Brushless Cordless Drill/Driver Kit



The 20V MAX Drill/Driver is lightweight and compact—great for working in tight spaces for long periods of time. High-speed transmission delivers two speed variations allowing users to choose the level of performance needed for various applications.

FEATURES & BENEFITS

- Two-speed high-speed transmission (0 to 600 and 0 to 2000 rpm) to meet a wide range of fastening and drilling applications
- A 1/2" ratcheting chuck provides superior bit grip
- 15 clutch settings allow you to adjust the torque to match the task at hand
- Ergonomic handle provides comfort and control

INCLUDES

DCD780 drill/driver, two 20V MAX 1.5 Ah batteries, charger, belt hook and contractor bag

C&M PART #	MFG PART #	DESCRIPTION
106702	DCD780C2	20V MAX Brushless Cordless Drill/Driver Kit

REPLACEMENT PARTS & ACCESSORIES

C&M PART #	MFG PART #	DESCRIPTION
106637	DCB205-2	20V MAX XR® 5 Ah Battery, 2/Pack

DeWALT® 20V MAX XR® Brushless Cordless Compact Drill/Driver & Impact Driver Combo Kit



The 20V MAX XR Compact Drill/Driver and Impact Driver feature a powerful brushless motor to deliver maximum run time. Lightweight, compact design allows usage in tight spaces. Both tools come with three LEDs to provide better visibility in dark spaces.

The **DCD791 1/2" Drill/Driver** with a high-efficiency brushless motor delivers up to 57% more runtime over brushed drill/driver. It measures only 6.9" front to back and weighs 3.4 lbs to easily fit into tight areas. A three-mode LED with 20-minute trigger release delay allows for extended work time in dark or dimly lit areas.

The **DCF887 1/4" Impact Driver** feature three speed settings for optimized application versatility. Simple one-handed loading 1/4" hex chuck with grip sleeve accepts 1" bit tips. Illuminate dimly lit work areas using the embedded three LEDs with 20-second trigger release delay.

INCLUDES

DCD791 1/2" Drill/Driver, DCF887 1/4" Impact Driver, two 20V MAX XR® 2 Ah (DCB203) batteries, charger, two belt hooks and contractor bag

C&M PART #	MFG PART #	DESCRIPTION
106676	DCK283D2	DeWALT® 20V MAX XR Brushless Cordless Compact Drill/Driver & Impact Driver Combo Kit

REPLACEMENT PARTS & ACCESSORIES

C&M PART #	MFG PART #	DESCRIPTION
106637	DCB205-2	DeWALT® 20V MAX XR 5Ah Battery, 2/Pack

SHOP ONLINE 24/7

Visit supply.coreandmain.com for easy access to thousands of products, specifications, SDS Sheets, product information and more!

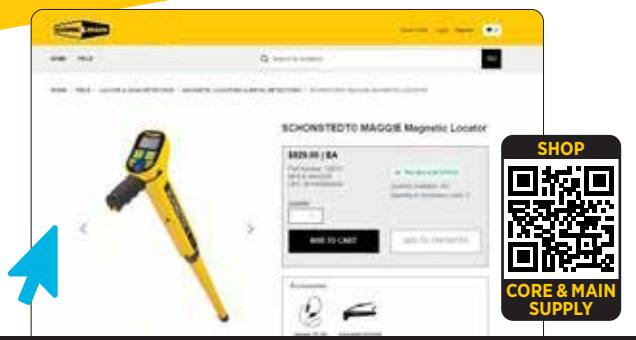

DeWALT® 20V MAX XR® Brushless Cordless Hammer Drill/Driver & Impact Driver Combo Kit



This convenient kit with a 20V MAX XR hammer drill/driver and impact driver is ideal for your tough fastening, drilling and hammering applications. Both tools feature a high-performance brushless motor to deliver maximum run time. Use the integrated LEDs to illuminate work areas for better visibility.

The **DCD996 1/2" Hammer Drill/Driver** with a high-power, high-efficiency brushless motor delivers up to 75% more runtime than 18V NiCd brushed motors. The three-speed, all-metal high-performance transmission optimizes tool-to-task for fast application speeds and improved run-time. The drill/driver comes equipped with a heavy-duty ratcheting nitro-carburized metal chuck with carbide inserts for superior bit gripping strength.

The **DCF887 1/4" Impact Driver** features three-speed settings for optimized application versatility. Compact and lightweight design makes it ideal for use in tight areas. Simple one-handed loading 1/4" hex chuck with grip sleeve accepts 1" bit tips. Use the three LEDs with 20 second delay after trigger release for better visibility.

INCLUDES

DCD996 hammer drill/driver, DCF887 impact driver, two 20V MAX XR 5 Ah batteries (DCB205), charger, two belt hooks, 360-degree side handle and kit box

C&M PART #	MFG PART #	DESCRIPTION
106677	DCK299P2	20V MAX XR Hammer Brushless Cordless Drill/Driver & Impact Driver Combo Kit

REPLACEMENT PARTS & ACCESSORIES

C&M PART #	MFG PART #	DESCRIPTION
106637	DCB205-2	DeWALT® 20V MAX XR 5Ah Battery, 2/Pack

DeWALT® 20V MAX XR® Brushless Cordless Compact Hammer Drill/Driver & Impact Driver Combo Kit



The 20V MAX XR Compact Hammer Drill/Driver and Impact Driver feature a powerful brushless motor to deliver maximum run time. Lightweight, compact design allows usage in tight spaces. Both tools come with three LEDs to provide better visibility in dark spaces.

The **DCD796 1/2" Hammer Drill/Driver** with a high-efficiency brushless motor delivers up to 57% more runtime over brushed hammer drill/driver. It measures 7.5" front to back and weighs only 2.7 lbs to easily fit into tight areas. A three-mode LED with 20-minute trigger release delay allows for extended work time in dark or dimly lit areas.

The **DCF887 1/4" Impact Driver** feature three speed settings for optimized application versatility. Simple one-handed loading 1/4" hex chuck with grip sleeve accepts 1" bit tips. Illuminate dimly lit work areas using the embedded three LEDs with 20-second trigger release delay.

INCLUDES

DCD796 hammer drill/driver, DCF887 impact driver, two 20V MAX XR 2 Ah batteries (DCB203), charger, two belt hooks and contractor bag

C&M PART #	MFG PART #	DESCRIPTION
106703	DCK287D2	20V MAX XR Brushless Cordless Compact Hammer Drill/Driver & Impact Driver Combo Kit

REPLACEMENT PARTS & ACCESSORIES

C&M PART #	MFG PART #	DESCRIPTION
106637	DCB205-2	DeWALT® 20V MAX XR 5Ah Battery, 2/Pack



Helpful Tip: Battery Care

How do you take care of cordless tool batteries?

Remove the battery from your cordless power tool before storage. Check the charge level and make sure that 2 LEDs are lit on your battery. If required, use a damp cloth to clean dirt and soil off the battery. Store the battery in a dry place and out of direct sunlight, in a closed box for example.

Also, you should stop using a battery as soon as you feel a substantial decrease in power from the tool. Completely running down a battery may damage it. See **page 430** for new batteries.



DeWALT® 20V MAX XR® Brushless Cordless Compact Hammer Drill/Driver with 4 Ah Battery & Impact Driver Combo Kit



The 20V MAX XR Compact Hammer Drill/Driver and Impact Driver feature a powerful brushless motor to deliver maximum run time. Lightweight, compact design allows usage in tight spaces. Both tools come with three LEDs to provide better visibility in dark spaces.

The **DCD796 1/2" Hammer Drill/Driver** with a high-efficiency brushless motor delivers up to 57% more runtime over brushed hammer drill/driver. It measures 7.5" front to back and weighs only 2.7 lbs to easily fit into tight areas. A three-mode LED with 20-minute trigger release delay allows for extended work time in dark or dimly lit areas.

The **DCF887 1/4" Impact Driver** feature three speed settings for optimized application versatility. Simple one-handed loading 1/4" hex chuck with grip sleeve accepts 1" bit tips. Illuminate dimly lit work areas using the embedded three LEDs with 20-second trigger release delay.

INCLUDES

DCD796 hammer drill/driver, DCF887 impact driver, 20V MAX XR 4 Ah battery (DCB204), 20V MAX XR 2 Ah battery (DCB203), charger, two belt hooks and contractor bag

C&M PART #	MFG PART #	DESCRIPTION
106704	DCK287D1M1	DeWALT® 20V MAX XR Hammer Drill and Impact Driver Combo Kit

REPLACEMENT PARTS & ACCESSORIES

C&M PART #	MFG PART #	DESCRIPTION
106637	DCB205-2	DeWALT® 20V MAX XR 5Ah Battery, 2/Pack

DeWALT® 20V MAX XR® Premium Four-Tool Combo Kit



This kit contains the tools you need to fasten, drill, hammer and cut in one convenient bag. The Hammer Drill/Driver, Impact Driver and Reciprocating Saw feature a brushless motor for increased service life and to deliver maximum run time.

The **DCD796 1/2" Hammer Drill/Driver** with a high-efficiency brushless motor delivers up to 57% more runtime over brushed hammer drill/driver. It measures 7.5" front to back and weighs only 2.7 lbs to easily fit into tight areas.

The **DCF887 1/4" Impact Driver** feature three speed settings for optimized application versatility. Compact and lightweight design makes it ideal for use in tight areas. Simple one-handed loading 1/4" hex chuck with grip sleeve accepts 1" bit tips.

The **DCS367 Reciprocating Saw** is compact and lightweight to help make your jobs easier. With a 1-1/8" stroke length and a variable-speed trigger delivering up to 2900 strokes/minute, this saw is fast and efficient. A keyless, lever-action four-position blade clamp offers quick and easy blade changes.

The **DCL040 LED Work Light** provides 160 lumens to illuminate your work area. Head rotates 120 degrees to easily shine it where you need it. Use the integral hook for hands-free application.

INCLUDES

DCD796 hammer drill/driver, DCF887 impact driver, DCS367 reciprocating saw, DCL040 work light, 20V MAX 2 Ah battery (DCB203), 20V MAX 4 Ah battery (DCB204), charger and kit bag

C&M PART #	MFG PART #	DESCRIPTION
106705	DCK487D1M1	20V MAX XR Premium Four-Tool Combo Kit

REPLACEMENT PARTS & ACCESSORIES

C&M PART #	MFG PART #	DESCRIPTION
106637	DCB205-2	20V MAX XR 5 Ah Battery, 2/Pack

DeWALT® 1-1/8" D-Handle SDS Rotary Hammer Kit



The 1-1/8" SDS+ Rotary Hammer is a lightweight, low-vibration, high-performance drill designed to meet the demands of today's contractors. It delivers 3.0 joules of impact energy for fast drilling and chipping speed. Using the Shocks Active Vibration Control® technology, this hammer reduces vibrations felt by the user for less user fatigue and greater productivity.

FEATURES & BENEFITS

- Shocks Active Vibration Control reduces vibration felt at the handles
- 8.5 amp high-performance motor
- Rotating brush ring delivers full power/torque in forward and reverse
- Integral clutch reduces sudden, high torque reactions if bit jams

C&M PART #	MFG PART #	DESCRIPTION
106706	D25263K	1-1/8" D-Handle SDS Hammer Kit, 115 VAC?

DeWALT® 20V MAX Brushless Cordless Hammer Drill/Driver with FLEXVOLT ADVANTAGE™

Take advantage of more power with 20V MAX brushless Hammer Drill/Driver with FLEXVOLT ADVANTAGE technology. When FLEXVOLT® batteries are installed, this tool delivers up to 42% more power than when standard 20V MAX batteries are used, making them ideal for many tough applications. A heavy-duty 1/2" ratcheting nitro-carburized metal chuck with carbide inserts provide superior bit grip strength. The hammer drill/driver is compatible with all DeWalt 20V MAX and FLEXVOLT batteries. Battery and charger sold separately.



FEATURES & BENEFITS

- Up to 42% more power when paired with FLEXVOLT batteries
- Three-mode LED provides lighting in dark or confined spaces
- A Tool Connect™ chip for easy asset management on the job site.

INCLUDES

360-degree side handle and belt hook

C&M PART #	MFG PART #	DESCRIPTION
106708	DCD999B	20V MAX Brushless Cordless 1/2" Hammer Drill/Driver with FLEXVOLT ADVANTAGE, Tool Only

REPLACEMENT PARTS & ACCESSORIES

C&M PART #	MFG PART #	DESCRIPTION
106643	DCB609-2	20V/60V MAX FLEXVOLT 9 Ah Battery, 2/Pack

DEWALT 20V MAX 1/2 in. Mid-Range Impact Wrench with Hog Ring Anvil

The 1/2" Impact Wrench with Detent Pin Anvil has a durable magnesium gear case and all-metal transmission for extended durability. Use it to drive and remove fasteners in wood, metal or concrete. Battery and charger sold separately.

FEATURES & BENEFITS

- Provides up to 400 ft-lbs of maximum torque to perform a wide range of heavy-duty fastening applications
- Ergonomic handle provides user superior comfort and control
- Variable-speed trigger with electric brake provides user improved control
- LED light provides user greater visibility when working in dark environments



C&M PART #	MFG PART #	DESCRIPTION
106766	DCF891B	DeWALT® 20V MAX High Torque 1/2" Impact Wrench, Tool Only

REPLACEMENT PARTS & ACCESSORIES

C&M PART #	MFG PART #	DESCRIPTION
106637	DCB205-2	DeWALT® 20V MAX XR 5Ah Battery, 2/Pack



DeWALT® Standard Reciprocating Saw, 12 Amp



The Reciprocating Saw has a powerful 12 amp motor with a variable-speed trigger that provides up to 2900 strokes/minute with a 1-1/8" stroke length for fast cutting. Use the four-position blade clamp for flush cutting and increased versatility. A keyless, lever-action blade clamp offers quick and easy blade changes.

FEATURES & BENEFITS

- Powerful 12-amp motor designed for heavy-duty applications
- Four-position blade clamp allows for flush cutting and increased versatility
- Keyless lever-action blade clamp for quick and easy blade changes
- 0-2900 strokes/minute and a 1-1/8" stroke length for fast and efficient cutting

C&M PART #	MFG PART #	DESCRIPTION
106740	DWE305	Standard Reciprocating Saw, 12 Amp

DeWALT® Bench Grinders



These 6" and 8" Bench Grinders have been extensively tested on real world job sites to ensure that they live up to your standards on heavy-duty grinding operations. The 6" bench grinder has a 5/8-hp, 3450 rpm induction motor and the 8" bench grinder has a 3/4-hp, 3600 rpm induction motor so you can be confident that the grinder will deliver strength when you need it.

FEATURES & BENEFITS

- Industrial cast iron base and motor housing
- Precision-machined aluminum tool rests
- Rear exhaust ports in wheel guards for smoother operation

INCLUDES

36-grit wheel, 60-grit wheel, eye shields, spark deflectors and tool rests

C&M PART #	MFG PART #	DESCRIPTION
106672	DW756	Bench Grinder, 6"
106673	DW758	Bench Grinder, 8"

DeWALT® Five-Piece SDS+ Hammer Bit Set

These bits with rock carbide tips deliver the best in durability and long life, so you can work confidently without worrying about breakage. With four cutter heads and two times more carbide than competitive two cutter bits, these bits are tough across multiple drilling operations, even in reinforced concrete. Elongated four-flute helix design removes debris faster while you work. For use with electric or cordless rotary hammers.



INCLUDES

3/16" x 4-1/2" x 6-1/2", 1/4" x 2" x 4", 1/4" x 4" x 6", 3/8" x 4" x 6" and 1/2" x 4" x 6" bits



C&M PART #	MFG PART #	DESCRIPTION
106707	DW5470	Five-Piece SDS+ Hammer Bit Set

Screw Extractor Sets

A screw extractor, also known as an easy-out or bolt extractor, is a tool used to remove screws or bolts that have become stripped, damaged, or stuck in a material. It is a specialized tool designed to grip the damaged screw or bolt and provide the necessary torque to loosen and extract it.



C&M PART #	MFG PART #	TYPE	MATERIAL	PIECES
106572	53545	Spiral Flute Screw Extractor Set	Steel	6
106573	11117	Drill Bit/Extractor Combo Set	Steel	10
106574	11119	Drill Bit/Extractor Set with Metal Index	Steel	10
106575	1876224	Double-Ended Screw Extractor Insert Bits	Steel	3

Irwin® Hanson® Tap, Die, Extractor and Drill Bit Set

This 117-piece Irwin® Hanson® set contains almost every tap, hex die, and drill bit a craftsman will need for maintenance and auto repair work. The deluxe tool set features tools perfectly crafted for hand-threading. Crafted of high carbon steel they provide the accuracy professional craftsmen rely on to get the job done right the first time.



C&M PART #	MFG PART #	DESCRIPTION	PIECES
106576	26377	Machine Screw/Fractional/Metric Tap, Die, Extractor & Drill Bit Set	117

DeWALT® Black Oxide Drill Bit Sets



These Drill Bits feature black oxide coating for maximum durability and nonslip start to power through a range of applications. Each bit has a 135-degree split point to help reduce walking while a parabolic flute eliminates bits from spinning in the chuck. A rugged container keeps bits organized and ready to use.

C&M PART #	MFG PART #	DESCRIPTION
106686	DW1163	13-Piece Black Oxide Drill Bit Set—(2) 1/16", 5/64", 3/32", 7/64", (2) 1/8", 9/64", 5/32", 3/16", 7/32" and 1/4"
106687	DW1167	17-Piece Black Oxide Drill Bit Set—(2) 1/16", 5/64", 3/32", 7/64", 1/8", 9/64", 5/32", 11/64", 3/16", 13/64", 7/32", 15/64", 1/4", 5/16", 3/8" and 1/2"

DeWALT® 29-Piece Pilot Point® Drill Bit Set



The Pilot Point tips help to keep the drill bit centered on workpiece and provides clean and accurate holes. The no-spin shank eliminates the frustration of bit spinning in the chuck while the tapered web provides greater durability to reduce breaking.

INCLUDES

1/16", 5/64", 3/32", 7/64", 1/8", 9/64", 5/32", 11/64", 3/16", 13/64", 7/32", 15/64", 1/4", 17/64", 9/32", 19/64", 5/16", 21/64", 11/32", 23/64", 3/8", 25/64", 13/32", 27/64", 7/16", 29/64", 15/32", 31/64" and 1/2" bits and rugged case

C&M PART #	MFG PART #	DESCRIPTION
106688	DW1969 G	29-Piece Pilot Point Drill Bit Set

DeWALT® Seven-Piece Premium Percussion Masonry Drill Bit Set

The Premium Percussion Masonry Drill Bits to easily power through masonry, concrete, rock, and more. Bits are manufactured from carbide for strength and durability and feature rock carbide tips that maximize surface contact for extended bit life. A four-flute design cleans debris out fast for efficient drilling. Three flats on the shank eliminate bit slippage. For use with electric or cordless hammer drills.



INCLUDES

3/16" x 3", (2) 1/4" x 4", 1/4" x 6", 5/16" x 6", 3/8" x 6" and 1/2" x 6" bits

C&M PART #	MFG PART #	DESCRIPTION
106689	DW5207	Seven-Piece Premium Percussion Masonry Drill Bit Set

IRWIN® Six-Piece Speedbor Drill Bit Set for Wood



These bits are specially designed for drilling wood. The cutting spurs have three cutting edges for added durability. A full screw tip allows bit to self feed while grooved hex shank prevents slipping in chuck. Tri-flute design cleans debris out fast for efficient drilling.

INCLUDES

1/2", 5/8", 3/4", 7/8", 1", 1-1/4"

C&M PART #	MFG PART #	DESCRIPTION
106693	IWAX236PC	Six-Piece Speedbor Drill Bit Set for Wood

LENOX Vari-Bit Step Drill Bits



The LENOX Vari-Bit Step Drill Bits with enhanced two flute design cuts fast, clean, burr-free holes. The enhanced flute design removes chips rapidly to ensure longer service life. Bits feature steam oxide coating for added durability.

C&M PART #	MFG PART #	DESCRIPTION
A VB1		
106775	30881VB1	Step Drill Bit, 1/8" to 1/2"
B VB2		
106771	30882VB2	Step Drill Bits, 1/2" to 1"
C VB3		
106773	30883VB3	Step Drill Bits, 1/4" to 3/4"
D VB7		
106770	30887VB7	Step Drill Bit, 7/8"
E VB8		
106769	30908VB8	Step Drill Bits, 3/16" to 7/8"
F VB11		
106772	30888VB11	Step Drill Bits, 7/8" to 1-1/8"
G VB12		
106768	30912VB12	Step Drill Bits, 7/8" to 1-3/8"
H 3-PIECE KIT		
106774	30889889	3-Piece Step Drill Bit Assortment, 1/8" to 1"

IRWIN® 29-Piece Drill Bit Sets with Metal Case



The M35 Cobalt Alloy Steel is a hard, heat- and wear-resistant metal that is ideal for drilling hard and abrasive materials. Each bit features 135-degree split point tips that start on contact and stays on work surface. Bits larger than 3/8" have a reduced shank so you can use the larger drill bits in a standard 3/8" chuck. The included case has removable cartridges to carry bits from case to work site safely.

The Titanium Nitride Coating-Nitride-Coated Drill Bits reduce friction and withstands heat, extending the life of the cutting edge and keeping it sharp. These drill bits are designed for repetitive metal drilling with portable drills and stationary drill presses. The 135-degree split point tip on each step drill bit starts drilling immediately and helps eliminate walking. Bits come in a convenient carrying case.

The Premium Black & Gold Oxide Finish high-speed steel bits withstand extended drilling in tough materials and provide maximum corrosion resistance. The 135-degree split point tip starts drilling immediately and helps eliminate walking across the work surface. Metal index case offers easy bit access and identification.

INCLUDES

Each 29-piece set in metal index case includes drill bit sizes 1/16" to 1/2" in 1/64" increments

C&M PART #	MFG PART #	DESCRIPTION
106690	3018002	Cobalt Alloy Steel M35 High-Speed Steel Drill Bit Metal Index Set
106691	3018003	Titanium Nitride-Coated Metal Index Drill Bit Set
106692	3018005	Black & Gold Metal Index Drill Bit Set

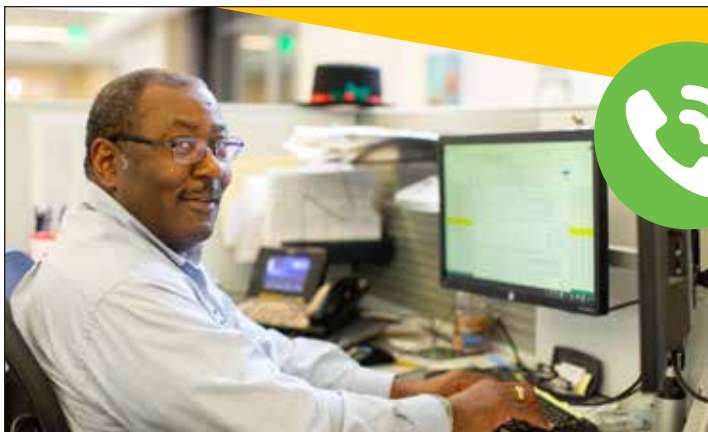

TALK TO AN EXPERT TODAY!

Need application advice or help to locate a part? Contact our technical specialists, they are here to help!

1-888-885-2673

DeWALT® Flap Discs



These type 29 Flap Discs are designed for grinding, blending and finishing applications. Each disc consists of multiple overlapping abrasive flaps that are bonded to a central hub and features zirconia grain 60 grit disc that removes material three times faster than fiber resin metal sanding disc. Flap discs are commonly used in metalworking, woodworking and fabrication industries.

C&M PART #	MFG PART #	SIZE (DIA x ARBOR)	MAX RPM
106694	DW8308	4-1/2" x 7/8"	13,300
106695	DW8312	4-1/2" x 5/8"-11	13,300
106697	DW8329	7" x 5/8"-11	8700

DeWALT® Grinding Wheels



Use these metal Grinding Wheels for various grinding and cutting applications. Made from aluminum oxide grain for durability, they are widely used in industries such as metalworking, construction, manufacturing and maintenance. Grinding wheels are designed to remove material from a workpiece, shape surfaces, and provide a smooth finish.

C&M PART #	MFG PART #	SIZE (DIA x THICKNESS x ARBOR)	MAX RPM
106698	DW4514	4-1/2" x 1/4" x 7/8"	13,300
106699	DW4523	4-1/2" x 1/4" x 5/8"-11	13,300
106700	DW4999	7" x 1/4" x 5/8"-11	8700
106701	DW8434	4-1/2" x 1/8" x 7/8"	13,300

DeWALT® Hole Saw Kits



106709



106710



The Hole Saw Kits are a collection of tools used for creating holes of various sizes and shapes in wood, plastic, metal or drywall. These kits include different sizes of hole saws, along with accessories that facilitate the cutting process.

INCLUDES

Kit 106709 includes: 3/4", 7/8", 1", 1-1/8", 1-3/8", 1-1/2", 1-3/4", 2", 2-1/8", 2-1/4", 2-1/2" hole saws; small quick-change mandrel and large quick-change mandrel

Kit 106710 includes: 3/4", 7/8", (2) 1-1/8" and 1-3/8" hole saws

C&M PART #	MFG PART #	NUMBER OF TOOLS	CUTTING MATERIAL
106709	D180005 V	14	Wood
106710	D18001R5	5	Metal

LENOX Speed Slot® Hole Saw Sets



Use these Hole Saw Sets for drilling holes in wood, metal, plastic and more. LENOX is a well-known brand that specializes in producing high-quality cutting tools, including hole saws. The enhanced tooth geometry of Speed Slot Hole Saws helps cut through material faster. The sets typically include a range of sizes to accommodate different hole diameters.

C&M PART #	MFG PART #	DESCRIPTION
106711	308042000G	26-Piece Contractor's Big Daddy™ Speed Slot Hole Saw Kit, 3/4" to 4-3/4"
106712	308011200P	17-Piece Plumber's Speed Slot Hole Saw Kit, 3/4" to 4-1/2"
106713	308201200G	17-Piece Contractor's Speed Slot Hole Saw Kit, 5/8" to 1-3/4"



DeWALT® Multi-Cutter Saw, 14"

This versatile Multi-Cutter Saw cuts a wide variety of materials including ferrous and nonferrous metals. Specially designed carbide teeth deliver fast, precise and virtually burr-free cuts. Ergonomically designed horizontal handle helps reduce user fatigue while increasing productivity.



C&M PART #	MFG PART #	DESCRIPTION
106721	DW872	Multi-Cutter Saw, 14"

DeWALT® Circular Saw Blade for Aluminum Cutting, 6.5"

The Aluminum Cutting Saw Blade, also known as a non-ferrous metal cutting saw blade, is a specialized cutting tool designed specifically for cutting aluminum and other non-ferrous metals. The blade features heavy-duty tungsten carbide tips for making clean cuts and anti-stick rim reduces friction and gum-up.



C&M PART #	MFG PART #	TYPE	CUTTING MATERIAL	DIAMETER	NO. OF TEETH	RPM
106723	DW9152	Circular Saw Blade	Aluminum and Non-Ferrous Metals	6.5"	36	7000

DeWALT® Replacement Blades



Use these replacement blades with circular saws to cut through various materials, including wood, metal, plastic and composite materials. Blades are made with 12% titanium carbide and feature modified ATB tooth geometry to provide clean, burr-free cuts.

C&M PART #	MFG PART #	TYPE	CUTTING MATERIAL	DIAMETER	NO. OF TEETH	RPM
106724	DWA7745	Circular Saw Blade	Light Gauge Metal	14"	90	1800
106725	DWAFV3724	Circular Saw Blade	Nail-Embedded Wood	7-1/4"	24	7000

LENOX Portable Band Saw Blades



Portable band saws are versatile cutting tools used for making curved and straight cuts. Use these durable yet flexible bimetal band saw blades with high-speed steel teeth for cutting metal, wood and plastic.

C&M PART #	MFG PART #	SIZE (L x W x THICKNESS)	TEETH/INCH	QUANTITY
WOLF-BAND SAW BLADES				
106726	3842538PW18	44-7/8" x 1/2" x 0.020"	18	25/Pack
106731	3842438PW14	44-7/8" x 1/2" x 0.020"	14	25/Pack
106732	3842738PW1418	44-7/8" x 1/2" x 0.020"	14/18	25/Pack
MASTER-BAND SAW BLADES				
106727	8011438EW1014	44-7/8" x 1/2" x 0.023"	10/14	3/Pack
106728	8011538EW14	44-7/8" x 1/2" x 0.023"	14	3/Pack
106729	9404B38EW14	44-7/8" x 1/2" x 0.023"	14	25/Pack
106730	8011638EW18	44-7/8" x 1/2" x 0.023"	18	3/Pack

LENOX MetalMax™ Diamond Edge Cutoff Wheel

The MetalMax Diamond Edge Wheels deliver 1000 or more cuts with no need for wheel changes. Rugged solid steel construction greatly reduce the risk of breakage. The combination of a steel body with a diamond edge allows the wheel to maintain its original wheel diameter until the very last cut, leading to better control, reach and cut precision throughout the wheel life.



FEATURES & BENEFITS

- Solid steel wheel body greatly reduces risk of breakage for added safety
- Delivers 1000 or more cuts without changing the wheel
- 30x longer life than thin bonded cutoff wheels
- Recommended for steel, sheet metal, stainless steel, rebar, cast iron, aluminum and nonferrous metals

C&M PART #	MFG PART #	DIMENSIONS	THICKNESS	MAX RPM
106680	1972921	4-1/2" x 7/8"	0.05"	13,200
106681	1972929	14" x 1"	0.13"	4300
106682	1972932	14" x 1"	0.13"	5300
106683	1972924	7" x 7/8"	0.06"	8400

DeWALT® Replacement 18 TPI Band Saw Blade

The Replacement 18 TPI Band Saw Blade is a continuous loop of a narrow, toothed metal strip that is used in a band saw machine to make straight or curved cuts in various materials. Band saws are versatile tools commonly used in woodworking, metalworking and other industries.



C&M PART #	MFG PART #	TYPE	CUTTING MATERIAL	SIZE (L x W x THICKNESS)	TEETH/ INCH	QUANTITY
106633	DW3983C	Band Saw Blade	Non-Ferrous Metal and Wood	32-7/8" x 1/2" x 0.020"	18	3/Pack

Stanley Hack Saw Frame & Blades



106588

106590



Heavy-duty hack saw easily cuts through metal, plastic and wood. Nice firm handle makes it easy to hold on to the saw. A quick-release blade changing mechanism in handle maintains tension setting. Position blade at 45 or 90 degree angle.

C&M PART #	MFG PART #	TYPE	MATERIALS TO CUT	BLADE LENGTH
106588	15-113	High Tension Hacksaw	Retractable	12"

REPLACEMENT PARTS & ACCESSORIES

C&M PART #	MFG PART #	MATERIALS TO CUT	BLADE LENGTH	TEETH/ INCH	QUANTITY
106591	15-928A	Mild-Steel, Cast Iron, Aluminum, Copper	12"	18	2/Pack
106590	15-924A	Soft Metal & Plastic	12"	24	2/Pack
106589	15-922A	Mild-Steel, Cast Iron, Aluminum, Copper	12"	32	2/Pack

IRWIN® Reciprocating Saw Blade



Use this Reciprocating Saw Blade to cut through materials that may contain embedded nails, such as wood with nails or lumber with metal fasteners. Durable yet flexible bimetal construction combined with high-speed steel teeth allow the blade to withstand the impact of hitting nails while maintaining cutting performance.

C&M PART #	MFG PART #	TYPE	CUTTING MATERIAL	LENGTH	TEETH/ INCH	QUANTITY
106738	372956BB	Reciprocating Saw Blade	Nail-Embedded Wood	9"	6	1/Pack

DeWALT® Reciprocating Saw Blades

The Reciprocating Saw Blades, also known as a sabre saw or recip saw, feature patented tooth forms that deliver fast, smooth cuts in wood and metals. The durable bimetal construction minimizes blade breaks and extend blade life. Kit 106737 contains 12 saw blades in a convenient carrying case.



C&M PART #	MFG PART #	TYPE	LENGTH	CUTTING MATERIAL	TEETH/ INCH	QUANTITY
106733	DW4802	Reciprocating Saw Blade	6"	Wood	6	5/Pack
106734	DW4803	Reciprocating Saw Blade	9"	Wood	6	5/Pack
106735	DW4811	Reciprocating Saw Blade	6"	Metal	18	5/Pack
106736	DW4821	Reciprocating Saw Blade	8"	Metal	18	5/Pack
106737	DW4892	Reciprocating Saw Blade	Varies*	Wood/ Metal	Varies	12/Pack

*This 12-piece kit contains DWAR656 (3), DWAR814 (3), DWAR618 (2), DWAR956 (3), and DWAR960 (1) saw blades.

LENOX Reciprocating Saw Blades



106750



106749



Reciprocating saws are versatile cutting tools used for cutting various materials, such as metal, wood and plastic. Bimetal blades featuring high-speed steel cutting edge bend and resist breaking extending blade life.

C&M PART #	MFG PART #	CUTTING MATERIAL	L x W	TEETH/ INCH	QUANTITY
106753	20530B656R	Nail-Embedded Wood	6" x 3/4"	6	25/Pack
106754	20558B956R	Nail-Embedded Wood	9" x 3/4"	6	25/Pack
106750	20582956R	Nail-Embedded Wood	9" x 1"	6	5/Pack
106757	20523B966R	Nail-Embedded Wood	9" x 1"	6	25/Pack
106744	20495B156R	Nail-Embedded Wood	12" x 3/4"	6	25/Pack
106746	20494B614R	Ferrous Metals	6" x 3/4"	14	25/Pack
106755	20529B618R	Ferrous Metals	6" x 3/4"	18	25/Pack
106748	20496B624R	Ferrous Metals	6" x 3/4"	24	25/Pack
106756	20487B818R	Ferrous Metals	8" x 3/4"	18	25/Pack
106745	20179B9114R	Ferrous Metals	9" x 1"	14	25/Pack
106747	20191B2118R	Ferrous Metals	12" x 1"	18	25/Pack
106751	20590B810R	Non-Ferrous Metals/ Plastics	8" x 3/4"	10	25/Pack
106752	10729810RPC	Wood/Metal	8" x 3/4"	10	250/Pack
106749	21510118R	Wood/Metal	12" x 3/4"	18	5/Pack

DeWALT® Wire Brushes

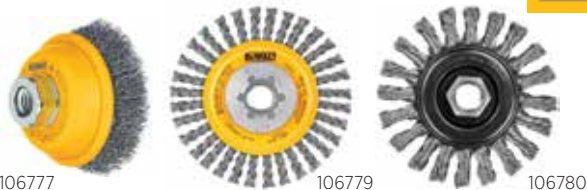

Attach these Wire Brushes to a power drill, turning them into powered wire brushes for various cleaning, rust removal and surface preparation tasks. Simply insert the metal shank or shaft of the brush into the drill chuck to turn it into a power brush.

Cup-Shaped Wire Brush is perfect for cleaning and deburring curved or irregular surfaces.

Disc Wire Brushes are flat, circular attachments with wire bristles arranged around the edge. They are suitable for surface cleaning and preparation tasks.

C&M PART #	MFG PART #	TYPE	BRUSH MATERIAL	DIAMETER
106777	DW4920	Crimped Wire Cup	Carbon	3"
106778	DW49204	Stringer Wire Disc	Stainless-Steel	4"
106779	DW4925	Stringer Wire Disc	Carbon	4"
106780	DW49255	Cable Twist Wire Disc	Stainless-Steel	4"
106781	DW4930	Cable Twist Wire Disc	Carbon	4"

LENOX Utility Knives



Use these versatile Utility Knives for various light-duty cutting tasks such as cutting through cardboard and plastic. Select from retractable or locking/folding blade for safety and ease of use. The retractable knife features a quick blade release that allows changing of blade without opening the handle. The multi-purpose locking/folding knife includes a bottle opener, screw driver, pipe reamer, and wire stripper.

C&M PART #	MFG PART #	TYPE	OPENING TYPE	SIZE (L x W)
106792	20353SSRK1	Utility Knife	Retractable	12" x 4"
106793	10771FLK1	Utility Knife	Foldable, Locking	9-1/8" x 4-3/4"

REPLACEMENT PARTS & ACCESSORIES

C&M PART #	MFG PART #	DESCRIPTION	QUANTITY
106785	20352GOLD100D	Titanium Coated Blades	100/Pack
106786	20351GOLD50D	Titanium Coated Blades	50/Pack

IRWIN® Self-Retracting Safety Knife



The Self-Retracting Safety Knife features a retractable blade mechanism that automatically returns the blade into the housing when not in use for enhanced safety. Two blade positions, 2 mm extension for box cutting and full extension for general use add to its versatility. All blades come in convenient dispenser to keep blades clean and sharp while keeping you safe.

C&M PART #	MFG PART #	TYPE	OPENING TYPE	SIZE (L x W)
106791	2088600	Utility Knife	Retractable	6" x 2"

REPLACEMENT PARTS & ACCESSORIES

C&M PART #	MFG PART #	DESCRIPTION	QUANTITY
106782	2083200	Carbon Steel Blades	100/Pack
106783	2084400	Bi-Metal Blue Blades	100/Pack
106784	2087102	Carbon Hook Blades	100/Pack

Stanley Retractable Utility Knives



Stanley utility knives are known for their durability, quality, and ergonomic designs. All knives feature retractable blades for safety and convenience, blade storage compartments for easy access to replacement blades, and ergonomic handles for comfortable grip and control during use.

In addition to utility knives, Stanley also provides a variety of replacement blades for their utility knives. These blades are designed to fit their specific knife models and are available in different materials, such as high-carbon steel or high-speed steel, to accommodate different cutting needs and preferences.

C&M PART #	MFG PART #	TYPE	OPENING TYPE	LENGTH
106794	10-099	Classic 99®	Retractable	6"
106795	10-788	Curved Quick-Change	Retractable	6-5/8"
106797	10-179	Hi-Visibility	Retractable	5-5/8"
106798	10-079	Interlock	Retractable	5-7/8"

REPLACEMENT PARTS & ACCESSORIES

C&M PART #	MFG PART #	DESCRIPTION	QUANTITY
106787	11-515	Single Edge Razor Blades	100/Pack
106788	11-700A	FatMax® Utility Blades	100/Pack
106789	11-800L	Carbide Utility Blades	50/Pack
106790	11-921A	Classic 1992 Utility Blades	100/Pack

Stanley Single Edge Razor Blades



Steel backed high-carbon steel blade fits most standard razor blade tools. These single-edge replacement blades for Stanley scrapers come 100 in a box.

C&M PART #	MFG PART #	DESCRIPTION	QUANTITY
106787	11-515	Single Edge Razor Blades	100/Pack

STANLEY Classic 1992 Utility Knife Blades



These heavy-duty, high-carbon steel blades fit most standard utility knives and are designed for long cutting life. Wall mount the included dispenser for convenient access to blades whenever you need them.

C&M PART #	MFG PART #	DESCRIPTION	QUANTITY
106790	11-921A	Classic 1992 Utility Knife Blades	100/Pack

Stanley Utility Knife Blades



The Stanley Utility Blades are the sharpest, strongest, longest lasting utility blade ever. They have a 75% longer life, are 35% sharper and 20% stronger than other blades (based on average values compared with Stanley 1992 blades).

C&M PART #	MFG PART #	DESCRIPTION	QUANTITY
106788	11-700A	FatMax® Utility Blades	100/Pack
106789	11-800L	Carbide Utility Blades	50/Pack

REPLACEMENT PARTS & ACCESSORIES

C&M PART #	MFG PART #	TYPE	OPENING TYPE
106794	10-099	Classic 99®	Retractable
106795	10-788	Curved Quick-Change	Retractable
106797	10-179	Hi-Visibility	Retractable
106798	10-079	Interlock	Retractable

IRWIN® Utility Knife Blades

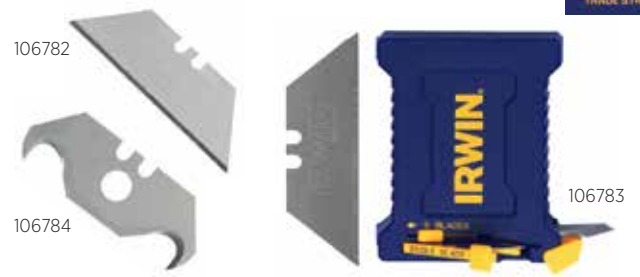

These Utility Knife Blades are designed to be durable, sharp, and long-lasting, making them suitable for a wide range of applications. All blades come in convenient dispenser to keep blades clean and sharp while keeping you safe. Select from different styles to meet your cutting needs. Each type has its own unique features and benefits, allowing you to choose the most suitable blade for their specific task.

C&M PART #	MFG PART #	DESCRIPTION	QUANTITY
106782	2083200	Carbon Steel Blades	100/Pack
106783	2084400	Bi-Metal Blue Blades	100/Pack
106784	2087102	Carbon Hook Blades	100/Pack

REPLACEMENT PARTS & ACCESSORIES

C&M PART #	MFG PART #	TYPE	OPENING TYPE
106791	2088600	Utility Knife	Retractable

LENOX Gold® Utility Knife Blades



These blades have a high-speed steel edge with titanium coating that keep the blades cutting after others have quit. The patented bi-metal construction allows the blades to bend and flex without breaking. The four-notch system allows the blade to extend further. Blades are compatible with all standard utility knives and are great for cutting drywall, insulation, flooring, roofing and more.

C&M PART #	MFG PART #	DESCRIPTION	QUANTITY
106785	20352GOLD100D	Titanium Coated Blades	100/Pack
106786	20351GOLD50D	Titanium Coated Blades	50/Pack

REPLACEMENT PARTS & ACCESSORIES

C&M PART #	MFG PART #	TYPE	OPENING TYPE
106792	20353SSRK1	Utility Knife	Retractable
106793	10771FLK1	Utility Knife	Foldable, Locking



Klein® Tools Insulated Screwdriver Sets



These Insulated Screwdriver Sets are designed for electrical applications and provide protection against electrical shock. The 1000 V rated screwdrivers feature a layer of bright orange impact and flame-resistant insulation allowing electricians and other professionals to safely work on live circuits. The Cushion-Grip™ handles provide excellent torque and comfort.

C&M PART #	MFG PART #	INCLUDES	PIECES
112282	32288	3/16" & (2) 1/4" Slotted, #1 & (2) #2 Phillips, and #1 & #2 Square	8
112283	85073INS	1/4" Slotted Tips, #2 Square and #2 Phillips	3
112284	85076INS	3/16" & 1/4" Slotted, #1 & (2) #2 Phillips and #2 Square	6
112288	33732INS	1/4" Slotted Tips and #2 Phillips	2

Klein® Tools Insulated Flip-Blade Screwdrivers

Get two screwdrivers in one with the Insulated Flip-Blade Screwdriver. The auto-eject mechanism feature works with just a twist, allowing you to flip from one end to the other end of the blade simply and easily. A bright orange coating of insulation protects you from electrical shock, as well as being flame and impact resistant. Screwdrivers exceed the ASTM F1505 standards for insulated tools and are clearly marked with the official 1000-Volt rating symbol. Cushion-Grip™ handle provides excellent torque and comfort.



C&M PART #	MFG PART #	DESCRIPTION
112281	32581INS	2-in-1 Screwdriver with #0 Phillips End and a 1/8" Slotted End
112285	32286	2-in-1 Screwdriver with #1 Phillips End and a 3/16" Slotted End
112286	32293	2-in-1 Screwdriver with #2 Phillips End and a 1/4" Slotted End
112287	32287	2-in-1 Screwdriver with #1 Square End and a #2 Square End

Klein® Tools Electronics Screwdrivers

These 4-in-1 Electronics Screwdrivers have a concealable tip and a swivel cap for precision and optimum control. To use, simply slide the cuff back to expose the tip and shaft. Flip the barrel to the long-side shaft to extend your reach. Corrosion-resistant anodized aluminum barrel includes two high-quality, double-ended tempered steel bits heat-treated for maximum strength. The Cushion-Grip™ handle provides excellent torque and comfort.



C&M PART #	MFG PART #	DESCRIPTION
112316	32581	Multi-Bit Electronics Screwdriver, 4-in-1, Phillips, Slotted Bits
112318	32614	Multi-Bit Electronics Pocket Screwdriver, 4-in-1, Phillips and Slotted Bits

KLEIN TOOLS MULTIMETER

Digital Multimeters are versatile tools used by electricians and repair technicians to measure various electrical parameters such as AC/DC voltage, current and resistance.

See **page 94** for more information on Klein Tools Multimeter.



Klein® Tools HVAC Screwdrivers



112315

112317



The Heating, Ventilation and Air Conditioning (HVAC) Screwdrivers are tailored to meet the unique needs of HVAC professionals. Specialized tips and shaft designs are suitable for installing, repairing and maintaining HVAC systems. The Cushion-Grip™ handle provides maximum comfort and torque.

C&M PART #	MFG PART #	DESCRIPTION
112315	32304	HVAC Adjustable-Length Impact Screwdriver with Flip Socket, 14-in-1
112317	32613	HVAC Pocket Screwdriver, 3-in-1, Phillips, Slotted, Schrader Bits

Klein® Tools Miscellaneous Screwdrivers



112292

112294

112293

112297

112299

112298



All screwdrivers feature chrome plated shaft for corrosion resistance and Cushion-Grip™ handle for greater torque and comfort. All models meet or exceed applicable ASME / ANSI specifications. Special heat-treated shafts and precision-machined tip provide exact fit to make your job easier. Select from various sizes and types to fit your application.

C&M PART #	MFG PART #	DESCRIPTION
112291	6004	1/4" Keystone Screwdriver, 4" Long Square Shank
112292	6006	5/16" Keystone Screwdriver, 6" Long Square Shank
112294	6034	#2 Phillips Screwdriver, 4" Long Round Shank
112293	6016	3/16" Cabinet Tip Screwdriver, 6" Long Round Shank
112295	6054	1/4" Cabinet Tip Screwdriver, 4" Long Round Shank
112296	6056	1/4" Cabinet Tip Screwdriver, Heavy Duty, 6" Long Round Shank
112297	6124	1/8" Cabinet Tip Terminal Block Screwdriver, TB-DIN, 4" Long Round Shank
112298	662	#2 Square Screwdriver, 4" Long Round Shank
112299	6706	3/16" Cabinet Tip Rapi-Driv® Screwdriver, 6" Round Rapi-Driv Shank

Klein® Tools Multi-Bit Screwdrivers & Nut Drivers



The Multi-Bit Screwdrivers and Nut Drivers lets you easily interchange bits, tips or heads so you can handle a variety of screw and nut types and sizes with just one tool. The multi-bit screwdrivers typically feature a handle with a storage compartment for the bits, making it easy to switch between different configurations. Cushion-Grip™ handle provides comfort and maximum torque during use.

C&M PART #	MFG PART #	DESCRIPTION
112306	32527	11-in-1 Screwdriver/Nut Driver; Phillips, Slotted, Square & Schrader Bits
112307	32596	8-in-1 HVAC Slide Drive™ Screwdriver/Nut Driver; Phillips & Slotted Bits
112309	32807MAG	7-in-1 Magnetic Screwdriver/Nut Driver
112310	32500	11-in-1 Screwdriver/Nut Driver; Phillips, Slotted, Square & TORX® Bits
112311	32500MAG	11-in-1 Magnetic Screwdriver/Nut Driver; Phillips, Slotted, Square & TORX® Bits
112312	32593	6-in-1 Ratcheting Stubby Screwdriver; Phillips & Slotted

STANLEY Quick Change 6-Way Screwdriver



The 6-in-1 Screwdriver combines multiple screwdriver bits with a single handle to create a versatile tool. Easily switch between different types and sizes of screwdriver bits without needing separate tools.

INCLUDES

1/4" standard, 3/16" standard, 1 pt. Phillips®, 2 pt. Phillips®, 1/4" nut driver and 5/16" nut driver

C&M PART #	MFG PART #	DESCRIPTION	HANDLE MATERIAL	MAGNETIC
106799	68-012	6-in-1 Multi-Bit Screwdriver	Plastic	No

DeWALT® 21-Piece Screwdriving Bit Set

This 21-Piece Screwdriving Bit Set contains a collection of various screwdriver bits and accessories designed for use with power drills or screwdrivers. Constructed of hardened steel, these bits provide excellent durability. A labeled slots for each bit in the ToughCase® case help keep bits organized.



INCLUDES

2" magnetic bit tip holder; bit tips: #1, (6) #2, and #3 Phillips; #6, #8, and #10 slotted; #1 and (3) #2 square recess; magnetic nut setters: 1/4" and 5/16"; power bits: 2" #2; 2" #2 square recess and case

C&M PART #	MFG PART #	DESCRIPTION
106761	DW2161	21-Piece Screwdriving Bit Set

STANLEY Screwdriver Sets



106801

106802

These Screwdriver Sets offer different combinations of screwdrivers, allowing you to have a range of options for different tasks. The 10-piece set comes with screwdrivers with molded, bi-material handle to accommodate precision, torque and speed applications. The 6-piece set comes with screwdrivers that have comfortable vinyl grip handles and precision formed black oxide tips.

C&M PART #	MFG PART #	DESCRIPTION	MAGNETIC	PIECES
106801	STHT60799	Plastic Grip Screwdriver Set	No	10
106802	66-565	Vinyl Grip Screwdriver Set	Yes	6

DeWALT® Toughseries™ 8-Piece Screwdriver Set

The Toughseries 8-Piece Screwdrivers equipped with S2 steel bar offer excellent durability and bend resistance. A black chrome finish and a nickel coated tip provide superior corrosion and rust resistance. Precision machined Max Fit® tips make better contact with fasteners to reduce both slippage and stripping. The soft, ergonomic, bi-material grip offers maximum comfort and torque.

INCLUDES

PH1 x 3", PH2 x 4", PH3 x 6", SL3/16" x 4", SL1/4" x 4", SL5/16" x 6", SQ1 x 3" and SQ2 x 4" screwdrivers

C&M PART #	MFG PART #	DESCRIPTION	MAGNETIC	HANDLE MATERIAL	PIECES
106800	DWHT65102	Combination Screwdriver Set	Yes	Plastic	8



Klein® Tools Conduit Fitting and Reaming Screwdriver



A Conduit Fitting and Reaming Screwdriver is a specialized tool designed for electricians and professionals working with conduit systems. Use this dual-purpose screwdriver for driving screws into conduit fittings, as well as for reaming both the inside and outside of the conduit at the same time. A sharp, tapered reaming blade removes burrs and debris from the inside of the conduit, ensuring smooth wire pulling and preventing damage to the wires. Comfort-Grip™ handle provides comfort and extra torque for easy and efficient use.

C&M PART #	MFG PART #	DESCRIPTION
112264	85191	Conduit Fitting and Reaming Screwdriver

Klein® Tools All-in-1 Precision Screwdriver Set with Case



The All-in-1 Precision Screwdriver Set comes with 39 precision bits in a compact carrying case. This set is ideal for working on small electronics that require specialized sizes. The reversible barrel is standard length on one side and extra-long on the other for those hard-to-reach jobs. Powerful magnets inside the barrel securely hold on to the bit as well as pick-up and retain fasteners. The Cushion-Grip™ handle and spin cap provide outstanding comfort and control.

C&M PART #	MFG PART #	DESCRIPTION
112324	32717	All-in-1 Precision Screwdriver Set with 39 Bits

DeWALT® Quick-Release Ratchets



These Quick-Release Ratchets have a 5-degree arc swing making it easy to maneuver in restricted areas. Contoured, ergonomically designed handle with anti-slip grooves makes these ratchets comfortable to use and provide added control. Chromium vanadium steel construction offers excellent strength and durability.

FEATURES & BENEFITS

- Quick-release button mechanism for positive lock on sockets
- 72-tooth gear system for high torque ratcheting

C&M PART #	MFG PART #	DRIVE SIZE
106843	DWMT81096	1/4"
106844	DWMT81098	1/2"

DeWALT® Drive Socket Sets



Turn bolts, nuts and other fasteners with the help of a socket wrench. These Drive Socket Sets include a range of socket sizes and accessories, all designed to fit a specific drive size. The most common drive sizes are 1/4", 3/8" and 1/2", although other sizes may also be available. All sets come with a lockable stacking case with durable transparent lid.

C&M PART #	MFG PART #	DRIVE SIZE	SOCKET DEPTH	TYPE	PIECES
106803	DWMT73804	1/4" & 3/8"	Shallow	SAE & Metric	34
106804	DWMT73805	1/4"	Shallow	SAE & Metric	25
106805	DWMT73806	3/8"	-	SAE & Metric Bit Set	17
106806	DWMT73807	1/4" & 3/8"	Deep	SAE	15
106807	DWMT73808	1/4"	-	Bit & Nut Driver	70
106808	DWMT73811	1/4"	Deep	SAE & Metric	20
106809	DWMT73812	3/8"	Deep	SAE & Metric	20
106810	DWMT73813	1/2"	Shallow	SAE & Metric	23
106811	DWMT73814	1/2"	Deep	SAE	10
106812	DWMT73815	1/2"	Deep	Metric	10

STANLEY Drive Socket Sets



Select Drive Socket Sets with different socket sizes, typically measured in inches or millimeters, to accommodate various fastener sizes. Some sets may include both metric and standard (imperial) sizes to cover a wider range of applications. Black chrome sets have laser-etched markings for size visibility and come in a hard case to help you stay organized. Black chrome finish provides anti-corrosion protection.

C&M PART #	MFG PART #	DRIVE SIZE	MATERIAL	SOCKET DEPTH	TYPE	PIECES
106814	92-824	1/4" & 3/8"	Black chrome	Shallow & Deep	SAE & Metric	69
106815	92-839	1/4" & 3/8"	Black chrome	Shallow & Deep	SAE & Metric	99
106816	85-434	1/2"	Steel	Shallow & Deep	SAE & Metric	26

Klein® Tools Impact Flip Sockets



Use the Impact Flip Socket with an impact driver. Flip feature allows for quick switching between drive sizes. Color coding provides easy size identification. Powerful rare-earth magnet holds bits and hex head fasteners. Precision machined and heat treated sockets provide a long service life.

C&M PART #	MFG PART #	DESCRIPTION
112308	66070	Flip Impact Socket 7-Piece Set; 3/8" x 7/16", 1/2" x 9/16", 5/8" x 11/16", 3/4" x 13/16" and 7/8" x 15/16"
112313	32900	7-in-1 Impact Flip Socket Set with Handle; 1/4", 5/16", 11/32", 3/8", 7/16" and 1/2"
112314	32907	7-in-1 Impact Flip Socket Set without Handle; 1/4", 5/16", 11/32", 3/8", 7/16" and 1/2"
112319	32766	3-in-1 Impact Flip Socket; 1/4", 5/16" and 3" Length
112320	32767	3-in-1 Impact Flip Socket; 1/4", 5/16" and 5" Length
112321	32768	3-in-1 Impact Flip Socket 2-Piece Set; 1/4" shallow, 1/4" deep and 5/16"



DeWALT® Mechanic's Tool Sets



The Mechanics Tool Sets, also known as mechanic socket sets or automotive socket sets, are specialized tools designed for automotive repair and maintenance tasks. These sets include a wide range of sockets, drive tools, and accessories specifically chosen to handle the diverse fasteners found in vehicles. Each set comes with a durable hard case that store all the pieces to help you stay organized.

C&M PART #	MFG PART #	DRIVE SIZE (in.)	SOCKET DEPTH	TYPE	PIECES
106817	DWMT73801	1/4 & 3/8	Deep & Shallow	SAE & Metric	108
106818	DWMT73802	1/4 & 3/8	Deep & Shallow	SAE & Metric	142
106819	DWMT73803	1/4 & 3/8 & 1/2	Deep & Shallow	SAE & Metric	168

Klein® Tools Premium 1000V Insulated Tool Kits



The Insulated Tools feature two-layer insulation to provide electric shock protection up to 1000 V. Tools meet or exceed IEC 60900: 2012 and ASTM F1505-10 standards for insulated tools.

The 13-piece kit comes with screwdrivers, pliers, cable cutter and skinning knife in a convenient carrying case. The custom case includes 2 pallets with pockets for each tool, a combination lock and two key-locked latches.

The 8-piece kit includes assorted pliers, screwdrivers, cable cutter and wire stripper in a black nylon case with custom-fitted tool pockets.

C&M PART #	MFG PART #	DESCRIPTION	PIECES
112289	33525	1000 V Insulated Utility Tool Kit in Hard Case	13
112290	33529	Premium 1000 V Insulated Tool Kit	8

STANLEY Mechanic's Tool Sets



Mechanic's Tool Sets include a wide range of tools commonly used by mechanics and automotive professionals such as sockets, wrenches, ratchets, screwdrivers, pliers, and more. Tools meet or exceed ANSI specifications. Set comes with a rugged carrying case that holds all the pieces.

C&M PART #	MFG PART #	DRIVE SIZE	MATERIAL	SOCKET DEPTH	TYPE	PIECES
106820	STMT71654	1/4", 3/8" & 1/2"	Polished chrome	Shallow & Deep	SAE & Metric	201
106821	FMMT71664	1/4", 3/8" & 1/2"	Black chrome	Shallow & Deep	SAE & Metric	179

STANLEY Toolboxes



Use these sturdy Toolboxes for organizing and storing tools. They are essential for keeping power tools, hand tools, and small parts protected and easily accessible. Removable top tray makes it easy to store and organize small parts; no need to dig through the large compartment to find them.

C&M PART #	MFG PART #	DESCRIPTION
106832	023001W	FatMax® Structural Foam Toolbox, 23" Wide
106833	STST16331	Essential™ Toolbox, 16" Wide
106834	STST19331	Essential™ Toolbox, 19" Wide

DeWALT® ToughSystem® Carriers and Storage Containers



The ToughSystem Storage System is a popular and well-regarded tool storage system designed by DeWalt. It is specifically tailored to provide durable and rugged storage solutions for professionals in construction, maintenance and other demanding industries. The versatile, mix and match storage system offers a range of storage options all designed to withstand tough working conditions and heavy use.

C&M PART #	MFG PART #	DESCRIPTION
DOLLIES		
106822	DWST08210	Carrier
106824	DWST08250	Mobile Storage
106831	DWST60436	2.0 Rolling Tower
STORAGE CONTAINERS		
106825	DWST08130	Storage Case
106826	DWST08201	Small Case
106827	DWST08203H	Large Case
106828	DWST08204	Extra-Large Case
106829	DWST08202	Organizer
106830	DWST08205	Tote

REPLACEMENT PARTS & ACCESSORIES

C&M PART #	MFG PART #	DESCRIPTION
106823	DWST08212	Extra Brackets for Carrier 106822, 2/Pack

LENOX Tool Storage Carriers



Keep your tools organized and easily accessible using these Tool Storage Carriers. Both carriers feature red interior for excellent tool visibility.

The Backpack has over 30 pockets of various sizes to help you keep your tools organized. Padded shoulder strap and back provides added cushioning for comfort. Durable 1680D nylon construction, reinforced stitching and water-resistant molded base withstands tough jobsite conditions.

The Plumber's Tote feature 9 exterior pockets, 14 interior pockets and 10 elastic loops for transporting everything you need for your job. Padded carrying handle and padded shoulder strap provide comfort when carrying tote. Hard plastic waterproof bottom ensures the bottom of the bag remains dry.

C&M PART #	MFG PART #	TYPE	SIZE (L x W x H)
106835	1894646	Backpack	14.5" x 7" x 17.5"
106836	1787474	Plumber's Tote	19" x 11" x 10"

STANLEY Professional Organizer



The Professional Organizer is designed for professionals and DIY enthusiasts to efficiently store and organize their tools, equipment and other items. The organizer comes with a high-impact, break-resistant clear lid so you can easily see the items. Removable cup compartments come in three different sizes. Unique lid design keeps storage cups locked in place. Extra-wide handle easily accommodates gloved hands.

C&M PART #	MFG PART #	DESCRIPTION
106837	014725R	25-Compartment Organizer

Pelican™ Black Protector Cases with Foam



The Pelican Protector Cases are designed for rugged travel and withstand the harshest environments on earth. Made in the USA, these tough cases are designed with an automatic purge valve that equalizes air pressure, a watertight silicone O-ring lid, over-molded rubber handles and stainless steel hardware.

FEATURES & BENEFITS

- Watertight, crushproof and dustproof
- Pick N Pluck™ with convoluted lid foam
- Strong, lightweight open cell core with solid wall design
- Easy open double throw latches
- Automatic purge valve keeps interior pressure balanced
- O-ring seal keeps water out
- Lifetime Guarantee of Excellence

C&M PART #	MFG PART #	MODEL	INTERIOR (L x W x H)	EXTERIOR (L x W x H)	WEIGHT (lbs)
107273	1200-000-110	1200	9.3" x 7.1" x 4.1"	10.7v x 9.8" x 4.9"	2.9
107274	1400-000-110	1400	11.8" x 8.9" x 6"	13.4" x 11.6" x 5.2"	4.4
107275	1500-000-110	1500	16.8" x 11.2" x 6.1"	18.5" x 14.1" x 6.9"	7.9
107276	1550-000-110	1550	18.6" x 14.2" x 7.7"	20.7" x 17.2" x 8.4"	11.9
107277	1600-000-110	1600	21.5" x 16.5" x 8"	24.4" x 19.4" x 8.8"	14.1
107278	1650-000-110	1650	28.6" x 17.5" x 10.7"	31.6" x 20.5" x 12.5"	28.1

Pelican™ Vault Black Standard Equipment Cases with Foam Insert



Store, protect and transport your gears using these crushproof, dustproof and weather-resistant Pelican Vault equipment cases. Built to safely transport a variety of high-level equipment and gear, cases feature four layers of foam inserts to ensure your equipment stays protected even in the toughest conditions.

FEATURES & BENEFITS

- High-impact polymer case and four layers of protective foam protects of your equipment
- Heavy-duty, ergonomic handle withstands even the toughest conditions
- Two push-button latches offer secure closure with easy-open access

C&M PART #	MFG PART #	MODEL	INTERIOR (L x W x H)	EXTERIOR (L x W x H)	WEIGHT (lbs)
107268	VCV100-0020-BLK	V100	11" x 8" x 4.5"	12.3" x 12" x 5.2"	3.5
107269	VCV300-0020-BLK	V300	16" x 11" x 6.5"	17.5" x 14.2" x 7.2"	6.7
107270	VCV550-0000-BLK	V550	19" x 14" x 8.5"	22.4" x 17.5" x 9.2"	10.7

Pelican™ Micro Cases



The Pelican Micro Cases are unbreakable, watertight, dustproof, chemical-resistant and corrosion-proof. These clear cases are made of copolymer and has a color liner. The case has a speed lock clear purge cap. The case can be attached to a belt or a strap using the included carabiner.

FEATURES & BENEFITS

- Easy open latch
- Automatic pressure equalization valve balances interior pressure and keeps water out
- Rubber liner doubles as O-ring seal
- Lifetime Guarantee of Excellence

C&M PART #	MFG PART #	MODEL	LINER COLOR	INTERIOR (L x W x H)	EXTERIOR (L x W x H)	WEIGHT (lbs)
107271	1050-025-100	1050	Black	6.3" x 3.7" x 2.8"	8" x 5.1" x 3.1"	0.8
107272	1060-025-100	1060	Blue	8.3" x 4.3" x 2.3"	9.9" x 5.6" x 2.6"	1

IRWIN® Vise-Grip Adjustable Wrenches with Steel Handle



The 18" and 24" Vise-Grip Adjustable Wrenches are made of chrome vanadium steel for maximum strength and hardness—ideal for maintenance and repair work. Black phosphate-coated handle offers excellent corrosion protection. Wrenches feature both English and metric scales and a hole for easy wall storage.

C&M PART #	MFG PART #	LENGTH
106839	1913190	18"
106840	1913311	24"

IRWIN® Vise-Grip 4-Piece Adjustable Wrench Set

The Vise-Grip Adjustable Wrench set includes four of the most used adjustable wrench sizes to tackle almost any job. Constructed of durable chrome vanadium steel, each wrench features machined jaws for maximum gripping strength and ProTouch™ grip for extra comfort and reduced hand fatigue.



INCLUDES

6", 8", 10" and 12" adjustable wrenches and a plastic storage tray

C&M PART #	MFG PART #	DESCRIPTION
106838	2078706	Adjustable Wrench Set, 4 Piece

STANLEY Adjustable Wrenches



These 8" and 10" Adjustable Wrenches feature an adjustable jaw design to easily grip many fastener sizes. Polished chrome finish offers excellent corrosion resistance. Use the knurl adjusting mechanism for quick and precise adjustments. Laser-etched SAE and metric jaw scale offer easy size adjustment.

C&M PART #	MFG PART #	LENGTH	JAW CAPACITY
106841	87-369	8"	1"
106842	87-471	10"	1-2/11"

Reed Heavy-Duty Aluminum Pipe Wrenches



Light yet strong, the aluminum pipe wrenches offer tighter tolerances for a snugger wrench, beefy housing for a stronger wrench and textured paint for a better grip. The titanium-aluminum alloy handle is heat-treated to provide maximum strength.

FEATURES & BENEFITS

- Heavy-duty yet lightweight aluminum wrench is great for overhead jobs
- Heat-treated handle provides excellent durability
- Textured paint on handle offers a great, nonslip grip

C&M PART #	MFG PART #	LENGTH	PIPE SIZE
103348	02097	18"	1/4 to 2-1/2"
103349	02099	24"	1/4 to 3"

Reed Smooth Jaw Wrench for 2" Corporation Stops



This large capacity Smooth Jaw Wrench will not mar chrome, brass or other fittings—excellent for geometric and delicate work. Wrench fits up to 2" corporation stops and open to a generous maximum size of 4-1/2". A coarse adjustment thread and a large thumbscrew provide quick, easy adjustments for the numerous size changes encountered during jobs.

FEATURES & BENEFITS

- Smooth jaws are gentle on finishes and visible surfaces
- All forged steel construction
- Fits 2" corporation stops
- Opens to 4-1/2" width

C&M PART #	MFG PART #	DESCRIPTION
103350	02114	2" Corporation Stop Wrench, 18" L

Reed Heavy-Duty Chain Wrenches

Use a chain wrench to turn all types of pipe fitting, from waterworks to plumbing in close quarters. Dual, reversible (and therefore more economical) jaws permit ratchet action in either direction without removing the chain wrench from the pipe. There is no need to hold up the wrench when placing the chain in the chain holder, the unique inline handle and jaw design allows the user to rest the wrench on the pipe.



FEATURES & BENEFITS

- Chain wrenches provide safe, reliable and powerful torque
- Move in either directions without removing the chain wrench from the pipe
- Rest the wrench on the pipe when placing the chain in the chain slot

C&M PART #	MFG PART #	LENGTH	PIPE SIZE
103346	02090	46"	1-1/2 to 8"
103347	02092	46"	2-1/2 to 12"

Reed 90-Degree Offset Heavy-Duty Aluminum Wrenches



Offset by 90 degrees, these aluminum wrenches provide longer swing and better access to hard-to-reach areas. Lightweight yet strong these wrenches offer tighter tolerances for a snugger wrench, beefy housing for a stronger wrench and textured paint for a better grip. The titanium-aluminum alloy is heat-treated for maximum strength.

FEATURES & BENEFITS

- 90-degree offset allows access to hard-to-reach places
- Heavy-duty yet lightweight aluminum wrench is great for overhead jobs
- Heat-treated handle provides excellent durability
- Textured paint on handle offers a great, nonslip grip

C&M PART #	MFG PART #	LENGTH	MAX PIPE SIZE
103351	02202	14"	2"
103352	02204	18"	2-1/2"

Reed One-Handed Wrenches



These unique One-Handed Wrenches feature spring-loaded jaws that quickly grips any shape without any adjustment. Wrenches work like a pipe wrench and provide better grip than pliers due to the jaws and tooth direction. Securely and immediately tighten and loosen without removing the wrench from the pipe.

FEATURES & BENEFITS

- Ratchets for easy one-handed operation—great for working in tight places
- Strong, forged steel handle
- Easily grips any shape such as meter nuts, round pipe, parts of fittings
- Saves time loosening nut due to ratchet action jaws

C&M PART #	MFG PART #	LENGTH	PIPE SIZE
103357	02281	11"	3/8 to 1"
103360	02289	16"	3/4 to 1-1/2"

Wheeler-Rex Aluminum Offset Pipe Wrenches



Use these Offset Wrenches with longer swing for better access to hard-to-reach areas. Constructed of aluminum, these lightweight yet strong wrenches feature forged I-beam handles for strength and durability without excess weight. Full floating jaws made of heat-treated alloy feature spring suspension for fast grip and release.

FEATURES & BENEFITS

- Offset design allows access to hard-to-reach places
- I-beam handles for strength and durability
- Nearly 50% less weight compared to iron wrenches
- Full floating jaws with spring suspension provide fast grip and release
- Heat-treated alloy steel replaceable jaws
- Parts are interchangeable with most major brands

C&M PART #	MFG PART #	LENGTH	MAX PIPE SIZE
101726	4814	14"	2"
101727	4818	18"	2-1/2"
101728	4824	24"	3"

Wheeler-Rex Aluminum Straight Pipe Wrenches



These Straight Pipe Wrenches are designed to provide a strong grip and leverage when working with pipes and fittings. Constructed of aluminum, these lightweight yet strong wrenches feature forged I-beam handles for strength and durability without excess weight. Full floating jaws made of heat-treated alloy feature spring suspension for fast grip and release. They are commonly used by plumbers and professionals in the construction industry for tasks such as tightening or loosening pipe connections.

FEATURES & BENEFITS

- I-beam handles for strength and durability
- Nearly 50% less weight compared to iron wrenches
- Full floating jaws with spring suspension provide fast grip and release
- Heat-treated alloy steel replaceable jaws
- Parts are interchangeable with most major brands

C&M PART #	MFG PART #	LENGTH	MAX PIPE SIZE
101698	4410	10"	1-1/2"
101699	4414	14"	2"
101700	4418	18"	2-1/2"
101701	4424	24"	3"
101702	4436	36"	5"
101703	4448	48"	6"

Wheeler-Rex Double-Up Wrenches

The Double Up Wrenches have a "bolt-thru" feature for tightening nuts on repair clamps and service saddles. Heavy-duty stamped and riveted construction provide durability and long service life.



FEATURES & BENEFITS

- Strong all-steel construction
- Vinyl comfort grip
- Easy reversing with a single lever

C&M PART #	MFG PART #	SOCKET SIZES
101872	9600	1-1/16" and 1-1/4"
101873	9601	15/16" and 1-1/8"

Wheeler-Rex Gripmaster Pipe Wrenches



Use the Gripmaster Pipe Wrenches for a fast, secure one-handed operation. These high-quality tools are designed for gripping and turning pipes, fittings and other plumbing components. The ergonomic design makes it easy to use and provides a secure grip. Spring-loaded jaws for fast placement on pipe and secure ratchet action.

FEATURES & BENEFITS

- One-handed operation
- Spring-loaded jaw for fast placement on pipe

C&M PART #	MFG PART #	LENGTH	MAX PIPE SIZE
101695	4310	10"	1-1/2"
101696	4314	14"	2"

Wheeler-Rex Heavy-Duty End Iron Pipe Wrenches



The Heavy-Duty End Iron Pipe Wrenches with slight offset jaws are ideal for areas with space restrictions. The end iron construction of the wrench provides increased strength and durability, allowing it to withstand high torque and pressure. The jaws of the wrench are serrated, providing a secure grip on pipes and preventing slippage during use. They are specifically designed to handle heavy-duty applications and are commonly used in plumbing, construction and industrial settings.

FEATURES & BENEFITS

- I-beam handles for strength and durability
- Full floating jaws with spring suspension provide fast grip and release
- Heat-treated alloy steel replaceable jaws
- Parts are interchangeable with most major brands

C&M PART #	MFG PART #	LENGTH	MAX PIPE SIZE
101722	4710	10"	1-1/2"
101723	4714	14"	2"
101724	4718	18"	2-1/2"

Wheeler-Rex Spud Wrench



The Spud Wrench is a specific type of wrench designed for use in plumbing and pipefitting applications. It features a narrow jaw to fit into small spaces. Use it for tightening and loosening nuts and bolts, particularly those found in plumbing fixtures and pipes. The smooth jaws do not mar chrome, brass or other fittings—excellent for delicate work. The term “spud” refers to a type of fitting or nut commonly used in plumbing.

FEATURES & BENEFITS

- I-beam handles for strength and durability
- Smooth jaws do not mar fittings

C&M PART #	MFG PART #	LENGTH	PIPE SIZE
101716	4612	12"	3/8 to 2-5/8"

Wheeler-Rex Heavy-Duty Straight Iron Pipe Wrenches



The Heavy-Duty Straight Iron Pipe Wrenches are powerful and durable tools used for gripping and turning pipes of various sizes. They are ideal for heavy-duty plumbing, construction and industrial applications. The straight iron construction of the wrench provides excellent strength and stability, allowing it to withstand high torque and pressure. The jaws of the wrench are serrated, providing a secure grip on pipes and preventing slippage during use.

FEATURES & BENEFITS

- I-beam handles for strength and durability
- Full floating jaws with spring suspension provide fast grip and release
- Heat-treated alloy steel replaceable jaws
- Parts are interchangeable with most major brands

C&M PART #	MFG PART #	LENGTH	MAX PIPE SIZE
101705	4508	8"	1"
101706	4510	10"	1-1/2"
101707	4512	12"	2"
101708	4514	14"	2"
101709	4518	18"	2-1/2"
101710	4524	24"	3"
101711	4536	36"	5"
101712	4548	48"	6"
101713	4560	60"	8"

Trumbull Meter Wrench



Use the Meter Wrench to install and remove meter couplings in buried meter boxes and meter pits. The 16" handle allows easy access into these confined areas; works with 1/2 to 1-1/2" meter couplings. Special features include resilient grip on handle and replaceable jaws.

FEATURES & BENEFITS

- Heat treated tool steel jaws with bright zinc plating
- EDP coated steel tubing
- Slip-resistant resilient grip

C&M PART #	MFG PART #	DESCRIPTION
101473	368-0620	Meter Wrench with 16" Handle

REPLACEMENT PARTS & ACCESSORIES

C&M PART #	MFG PART #	DESCRIPTION
101474	368-0625	Meter Wrench, Replacement Jaw Set

Reed Thru-Bolt™ 4-in-1 Ratchet Wrenches



Get four socket sizes in one wrench! The Thru-Bolt 4-in-1 Ratchet Wrenches feature four different sockets on one wrench so there is no need to carry multiple wrenches for your job. The sockets stay on the handle, which means there are no loose sockets to misplace. The length and design of the handle provide maximum leverage while the rugged, textured handle grip ensures a secure hold for the operator. The Thru-Bolt sockets let the bolt pass completely through the socket and arm head so tightening nuts on long bolts or all-thread rod is never a problem.

FEATURES & BENEFITS

- Carry one wrench for all your jobs—four socket sizes on one handle
- Sockets are designed to stay on the handle, meaning no loose sockets
- Rugged yet smooth grip handle construction
- Length and shape of handle yield maximum leverage

C&M PART #	MFG PART #	DESCRIPTION	LENGTH	SOCKET SIZES
103388	02690	Open Edges	17"	15/16", 1-1/16", 1-1/8", and 1-1/4"
103596	02692	Sealed Edges	17"	15/16", 1-1/16", 1-1/8", and 1-1/4"

Reed Thru-Bolt™ Dual Socket Ratchet Wrenches



Each Dual Socket Ratchet Wrench comes with two different socket sizes in a single wrench, eliminating the need to switch between different wrenches or sockets. Open socket center with through bolt design (Thru-Bolt) fits on nuts on any threaded length. Reversible ratchet mechanism tighten or loosen bolts and nuts in both directions.

FEATURES & BENEFITS

- Through bolt design fits on nuts on any thread length
- Economical wrenches combine two popular socket sizes into one tool
- Rugged construction of handle and ratchet mechanism
- Ergonomic grip on handle reduces hand fatigue



C&M PART #	MFG PART #	DESCRIPTION	LENGTH	SOCKET SIZE
103356	02251	Heavy Duty	13"	1-1/4" and 1-1/16"
103389	02695	Adjustable	17"	1-1/4" and 1-1/16"
103392	02930	3 Wrench Kit	13"	1-1/4", 1-1/16", 1-1/8", 15/16", 3/4", 7/8", 19 mm, and 22 mm
103393	02950	Value Line	13"	1-1/4" and 1-1/16"

Trumbull Double-Socket Ratchet Wrenches

These Double-Socket Ratchet Wrenches eliminate the need to switch between different wrenches or sockets, saving you time and effort. A convenient reversible ratchet mechanism lets you to tighten or loosen bolts and nuts in both directions. Heavy-duty ratchet mechanism sandwiched between steel plates provide extra strength and protection. Easily tighten nuts on long bolts or all-thread rod without bottoming out. Pivoting handle wrench is ideal for accessing those hard-to-reach nuts and bolts.



101462

101463

101464

101465

C&M PART #	MFG PART #	DESCRIPTION	SOCKET SIZES
101462	364-9986	Double-Socket Ratchet Wrench, 3 Wrench Set (includes three double-socket ratchet wrenches listed below, OD tape, and carrying case)	7/8", 3/4", 15/16", 1-1/16", 1-1/8", and 1-1/4"
101463	364-9979	Double-Socket Ratchet Wrench, Blue	1-1/16" and 1-1/4"
101464	364-9989	Double-Socket Ratchet Wrench, Green	15/16" and 1-1/8"
101465	364-9990	Double-Socket Ratchet Wrench, Yellow	3/4" and 7/8"
101466	364-9984	Pivoting Handle Double-Socket Wrench	1-1/16" and 1-1/4"



101466

Local Knowledge
Local Experience
Local Service, Nationwide®

Count on Core & Main to provide a quality product assortment from trusted brands, access to industry and product experts, and best-in-class service.



Wheeler-Rex Soil Pipe Torque Wrenches

The Soil Pipe Torque Wrenches, also known as cast iron soil pipe wrenches, are specialized tools used in plumbing and pipefitting applications to tighten or loosen soil pipe fittings and clamps. They are commonly used with cast and ductile iron piping.



C&M PART #	MFG PART #	DRIVE SIZES	MAXIMUM TORQUE
101669	1977	5/16"	60 in-lbs
101670	1980	5/16"	80 in-lbs
101671	1981	3/8"	80 in-lbs
101672	1982	5/16" and 3/8"	80 in-lbs

Reed Torque Wrench

Torque Wrench for cast iron soil pipe is engineered to provide recommended torque on No-Hub® soil pipe connections/fitting clamps. Torque wrench can also loosen clamp screws and is designed for hand comfort. Ratcheting action is fast and maximum torque is preset. It releases with a click when reached for secure, leak free joints.



FEATURES & BENEFITS

- Sturdy zinc body with steel components provide excellent durability
- Guaranteed accurate to ±10%
- Engineer to provide recommended torque

C&M PART #	MFG PART #	DRIVE SIZE	LENGTH	MAXIMUM TORQUE
103362	02698	5/16"	6"	60 in-lbs

Reed Single-End Aluminum Valve Wheel Wrenches



Valve Wheel Wrenches grip the rims of hand valve wheels securely to provide leverage for opening and closing hard-to-open valves. Wrenches offer a low-sparking benefit due to aluminum-magnesium alloy construction. Specially designed safety feature causes the wrench to bend before it breaks, thus warning users of excess loads.

C&M PART #	MFG PART #	LENGTH	MAXIMUM HOOK OPENING
103390	02851	14"	1-3/8"
103391	02852	18"	1-3/4"

DeWALT® 8-Piece Combination Wrench Sets



The Combination Wrench Sets include both open-end and box-end wrenches. A long panel design allows for more reach during use while providing more torque to a fastener. Sizes stamped twice on both sides offer easy side identification. The DirectTorque™ technology helps prevent the rounding of fasteners.

FEATURES & BENEFITS

- Stamped hashmark pattern on wrench handle provides added grip points
- Lockable stacking case allow for easy transport
- Durable transparent lid
- Exceeds ANSI specifications

C&M PART #	MFG PART #	DESCRIPTION	SIZES
106845	DWMT73809	SAE 8-Piece Set	1/4", 5/16", 3/8", 7/16", 1/2", 9/16", 5/8", and 11/16"
106846	DWMT73810	Metric 8-Piece Set	10, 11, 12, 13, 14, 15, 16, and 17 mm

STANLEY 14-Piece SAE Combination Wrench Set



This 14-piece SAE Combination Wrench Set includes both open-end and box-end wrenches. The box end employs the Max-Drive™ system ensuring 15% more torque is applied to the fastener reduce fastener rounding.



FEATURES & BENEFITS

- Max-Drive system helps reduce fastener rounding
- Convenient roll-out bag makes it easy to carry around
- Stanley wrenches are designed to meet or exceed ANSI specifications.
- Limited lifetime warranty

C&M PART #	MFG PART #	DESCRIPTION	SIZES
106847	85-990	SAE Wrench Set	3/8", 7/16", 1/2", 9/16", 5/8", 11/16", 3/4", 13/16", 7/8", 15/16", 1", 1-1/16", 1-1/8", and 1-1/4"

Valves



TABLE OF CONTENTS

Solenoid Valves	470
PVC Ball Valves	471-472
CPVC Ball Valves	472-473
Check Valves	474-475
Gate Valves	476

Asco 8210-Series General Purpose Solenoid Valves



Use these highly reliable, economical 8210 Series Two-Way Solenoid Valves for liquid and corrosive and air/inert services. A wide range of pressure ratings, sizes and materials provide long service life and low internal leakage. Industrial applications include water/ wastewater, pumps, air compressors and much more. Select from brass and stainless steel (SS) body valves. Brass body valves offer durability at a low cost; SS valves offer excellent chemical resistance.

C&M PART #	MFG PART #	SIZE
GENERAL-PURPOSE, BRASS, NORMALLY CLOSED		
10712713PJNC	8210G093 AC 120/60,110/50 D	3/8"
10712713OENC	8210G094 AC 120/60,110/50 D	1/2"
10712713OFNC	8210G095 AC 120/60,110/50 D	3/4"
1071271330NC	8210G054 AC 120/60 D	1"
1071271334NC	8210G055 AC 120/60 D	1-1/4"
1071271340NC	8210G056 AC 120/60 D	1-1/2"
GENERAL-PURPOSE, BRASS, NORMALLY OPEN		
10713713PJNO	8210G033 AC 120/60,110/50 D	3/8"
10713713OENO	8210G034 AC 120/60,110/50 D	1/2"
10713713OFNO	8210G035 AC 120/60,110/50 D	3/4"
1071371330NO	8210B057 AC 120/60,110/50 D	1"
1071371334NO	8210B058 AC 120/60,110/50 D	1-1/4"
1071371340NO	8210B059 AC 120/60,110/50 D	1-1/2"
1071371350NO	8210G103 AC 120/60 D	2"

Note: Minimum operating differential pressure is 5 psi.

This number refers to the difference in pressure that must be maintained at the inlet port relative to outlet port for valve to function properly.

FEATURES & BENEFITS

- Use for both liquid and air service
- NBR seals prevent leakage
- 1/2" NPT conduit connection with 18" leads
- Safety shutoff valve: minimum operating differential pressure is 5 psi

CERTIFICATIONS

- UL Listed, CSA Certified

C&M PART #	MFG PART #	SIZE
GENERAL-PURPOSE, BRASS, NORMALLY CLOSED, SAFETY SHUTOFF		
1071311330NC	8210G004 AC 120/60,110/50 D	1"
1071311334NC	8210G008 AC 120/60,110/50 D	1-1/4"
1071311340NC	8210G022 AC 120/60,110/50 D	1-1/2"
1071311350NC	8210G100 AC 120/60,110/50 D	2"
STANDARD BRASS, LEAD-FREE, NORMALLY CLOSED		
10714413OENC	8210G094LF AC 120/60,110/50 D	1/2"
10714413OFNC	8210G095LF AC 120/60,110/50 D	3/4"
1071441330NC	8210G054LF AC 120/60 D	1"
STANDARD BRASS, LEAD-FREE, NORMALLY CLOSED, SAFETY SHUTOFF		
10714513OENC	8210G002LF AC 120/60,110/50 D	1/2"
10714513OFNC	8210G009LF AC 120/60,110/50 D	3/4"
STANDARD STAINLESS STEEL, NORMALLY CLOSED		
107153B6PJNC	8210G036 AC 120/60,110/50 D	3/8"
107153B6OENC	8210G087 AC 120/60,110/50 D	1/2"
107153B6OFNC	8210G088 AC 120/60,110/50 D	3/4"
107153B630NC	8210G089 AC 120/60 D	1"
STANDARD STAINLESS STEEL, NORMALLY OPEN		
107153B6OENO	8210G030 AC 120/60,110/50 D	1/2"
107153B6OFNO	8210G038 AC 120/60,110/50 D	3/4"



Helpful Tip: Flow Control Solenoid Valves Explained

A solenoid valve is an electromechanical device used to control the flow of fluids, typically liquids or gases, through a pipe or tubing system. It operates by using an electromagnetic solenoid to actuate a valve, allowing or blocking the flow of the fluid. Solenoid valves are commonly used in various applications, including plumbing, industrial processes, automation, and control systems.

Solenoid Coil: The core component of a solenoid valve is the solenoid coil, which is an electromagnetic coil of wire. When an electric current passes through the coil, it generates a magnetic field.

Plunger or Armature: Connected to the solenoid coil is a plunger or armature, which is a movable component. The magnetic field generated by the coil causes the plunger to move.

Valve Mechanism: The movement of the plunger is used to control a valve mechanism. In most solenoid valves, this involves opening or closing a port that allows or restricts the flow of fluid through the valve.

Flow Control: Solenoid valves can be designed as either normally open (NO), normally closed (NC), or as a three-way valve. In a normally open valve, the flow is allowed in its default state, and the valve closes when the solenoid is energized. In a normally closed valve, the flow is blocked by default, and the valve opens when the solenoid is energized.

Spears True Union 2000 Industrial PVC Ball Valves

These Industrial True Union 2000 Industrial PVC Ball Valves are made from polyvinyl chloride (PVC) to provide excellent chemical resistance and durability. Industrial PVC ball valves are commonly used in applications where corrosion resistance, chemical compatibility, and ease of maintenance are important. They are often used in industries such as water treatment, chemical processing, agriculture, and more.

FEATURES & BENEFITS

- Rated to 235 psi @ 73° F
- Made in the U.S.A.

CERTIFICATIONS

- ASTM D1784



C&M PART #	MFG PART #	SIZE	CONNECTION 1	SEAL
400038F4A119	1829-005	1/2"	Threaded/Socket	EPDM
400038F4A13V	1829-007	3/4"	Threaded/Socket	EPDM
400038F4A130	1829-010	1"	Threaded/Socket	EPDM
400038F4A134	1829-012	1-1/4"	Threaded/Socket	EPDM
400038F4A140	1829-015	1-1/2"	Threaded/Socket	EPDM
400038F4A150	1829-020	2"	Threaded/Socket	EPDM
400038D1A170	1822-025	2-1/2"	Socket	EPDM
400038D1A187	1822-030	3"	Socket	EPDM
400038D1A1C1	1822-040	4"	Socket	EPDM
400038F4A219	1839-005	1/2"	Threaded/Socket	FKM
400038F4A23V	1839-007	3/4"	Threaded/Socket	FKM
400038F4A230	1839-010	1"	Threaded/Socket	FKM
400038F4A234	1839-012	1-1/4"	Threaded/Socket	FKM
400038F4A240	1839-015	1-1/2"	Threaded/Socket	FKM
400038F4A250	1839-020	2"	Threaded/Socket	FKM
400038D1A270	1832-025	2-1/2"	Socket	FKM
400038D1A287	1832-030	3"	Socket	FKM
400038D1A2C1	1832-040	4"	Socket	FKM
400038F5A119	1821-005SR	1/2"	SS Reinforced Threaded	EPDM
400038F5A13V	1821-007SR	3/4"	SS Reinforced Threaded	EPDM
400038F5A130	1821-010SR	1"	SS Reinforced Threaded	EPDM
400038F5A134	1821-012SR	1-1/4"	SS Reinforced Threaded	EPDM
400038F5A140	1821-015SR	1-1/2"	SS Reinforced Threaded	EPDM
400038F5A150	1821-020SR	2"	SS Reinforced Threaded	EPDM
400038F5A170	1821-025SR	2-1/2"	SS Reinforced Threaded	EPDM
400038F5A187	1821-030SR	3"	SS Reinforced Threaded	EPDM
400038F5A1C1	1821-040SR	4"	SS Reinforced Threaded	EPDM
400038F5A219	1831-005SR	1/2"	SS Reinforced Threaded	FKM
400038F5A23V	1831-007SR	3/4"	SS Reinforced Threaded	FKM
400038F5A230	1831-010SR	1"	SS Reinforced Threaded	FKM
400038F5A234	1831-012SR	1-1/4"	SS Reinforced Threaded	FKM
400038F5A240	1831-015SR	1-1/2"	SS Reinforced Threaded	FKM
400038F5A250	1831-020SR	2"	SS Reinforced Threaded	FKM
400038F5A270	1831-025SR	2-1/2"	SS Reinforced Threaded	FKM
400038F5A287	1831-030SR	3"	SS Reinforced Threaded	FKM
400038F5A2C1	1831-040SR	4"	SS Reinforced Threaded	FKM

Spears True Union PVC Ball Valves



Use these True Union PVC Ball Valves for controlling the flow of fluids in polyvinyl chloride (PVC) piping systems. PVC is a widely used thermoplastic material known for its durability, affordability and chemical resistance.

The true union design of these ball valves allows for easy installation, maintenance, and repair. They feature a union connection that enables the valve to be disassembled from the piping system without the need for cutting or removing the entire pipe. This makes servicing or replacing the valve more convenient and cost-effective.

FEATURES & BENEFITS

- Rated to 235 psi (1/2 to 2"); 150 psi (2-1/2 to 4") @ 73° F
- Made in the U.S.A.

CERTIFICATIONS

- ASTM D1784

C&M PART #	MFG PART #	SIZE	CONNECTION	SEAL
400014F4A119	2329-005	1/2"	Threaded/Socket	EPDM
400014F4A13V	2329-007	3/4"	Threaded/Socket	EPDM
400014F4A130	2329-010	1"	Threaded/Socket	EPDM
400014F4A134	2329-012	1-1/4"	Threaded/Socket	EPDM
400014F4A140	2329-015	1-1/2"	Threaded/Socket	EPDM
400014F4A150	2329-020	2"	Threaded/Socket	EPDM
400014F3A170	2321-025	2-1/2"	Threaded	EPDM
400014D1A170	2322-025	2-1/2"	Socket	EPDM
400014F3A187	2321-030	3"	Threaded	EPDM
400014D1A187	2322-030	3"	Socket	EPDM
400014F3A1C1	2321-040	4"	Threaded	EPDM
400014D1A1C1	2322-040	4"	Socket	EPDM
400014F4A219	2339-005	1/2"	Threaded/Socket	FKM
400014F4A23V	2339-007	3/4"	Threaded/Socket	FKM
400014F4A230	2339-010	1"	Threaded/Socket	FKM
400014F4A234	2339-012	1-1/4"	Threaded/Socket	FKM
400014F4A240	2339-015	1-1/2"	Threaded/Socket	FKM
400014F4A250	2339-020	2"	Threaded	FKM
400014F3A270	2331-025	2-1/2"	Socket	FKM
400014D1A270	2332-025	2-1/2"	Threaded	FKM
400014F3A287	2331-030	3"	Socket	FKM
400014D1A287	2332-030	3"	Threaded	FKM
400014F3A2C1	2331-040	4"	Socket	FKM
400014D1A2C1	2332-040	4"	Threaded/Socket	FKM



Spears True Union 2000 PVC Industrial Vented/Bleach Ball Valves

The True Union 2000 PVC Industrial Vented/Bleach Ball Valves typically have a special ball vent design for sodium hypochlorite (bleach) and other chemical applications where entrapped fluids may form caustic crystalline residues and pressure build up from gases developed. Valves have a 1/8" vent hole in ball to equalize internal fluid pressures. Install valve with ball vent on the pressure (upstream) side when in closed position.

Note: PVC is generally resistant to a wide range of chemicals, including bleach. However, it's important to consider the specific requirements of your application and ensure that the valve materials are compatible with the chemicals and substances used. Install valve with ball vent on the pressure (upstream) side when in closed position.

FEATURES & BENEFITS

- Rated to 235 psi @ 73° F
- Made in the U.S.A.

CERTIFICATIONS

- ASTM D1784



C&M PART #	MFG PART #	SIZE	CONNECTION	SEAL
400110F4A219	1839V-005	1/2"	Threaded/Socket	FKM
400110F4A23V	1839V-007	3/4"	Threaded/Socket	FKM
400110F4A230	1839V-010	1"	Threaded/Socket	FKM
400110F4A234	1839V-012	1-1/4"	Threaded/Socket	FKM
400110F4A240	1839V-015	1-1/2"	Threaded/Socket	FKM
400110F4A250	1839V-020	2"	Threaded/Socket	FKM
400110D1A270	1832V-025	2-1/2"	Socket	FKM
400110D1A287	1832V-030	3"	Socket	FKM
400110D1A2C1	1832V-040	4"	Socket	FKM

Spears True Union 2000 PVC Retrofit Other Brands Ball Valves

The True Union Retrofit design allows for easy installation and replacement of ball valves without the need for extensive modifications to the piping system. Retrofit valve consists of standard true union 2000 PVC ball valve plus factory installed extended-socket end connectors. It is specifically designed to fit and adapt to the dimensions and connections of other ball valve brands, making it a convenient solution for upgrading or replacing valves in existing installations. Simply cut out old valve to specified dimensions and install retrofit valve end connectors.

FEATURES & BENEFITS

- Rated to 235 psi (1/2 to 2") @ 73° F
- Made in the U.S.A.

CERTIFICATIONS

- ASTM D1784



C&M PART #	MFG PART #	SIZE	CONNECTION	SEAL
400128D1A119	3622R-005	1/2"	Socket	EPDM
400128D1A13V	3622R-007	3/4"	Socket	EPDM
400128D1A130	3622R-010	1"	Socket	EPDM
400128D1A134	3622R-012	1-1/4"	Socket	EPDM
400128D1A140	3622R-015	1-1/2"	Socket	EPDM
400128D1A150	3622R-020	2"	Socket	EPDM
400128D1A170	3622R-025	2-1/2"	Socket	EPDM
400128D1A187	3622R-030	3"	Socket	EPDM
400128D1A1C1	3622R-040	4"	Socket	EPDM
400128D1A219	3632R-005	1/2"	Socket	FKM
400128D1A23V	3632R-007	3/4"	Socket	FKM
400128D1A230	3632R-010	1"	Socket	FKM
400128D1A234	3632R-012	1-1/4"	Socket	FKM
400128D1A240	3632R-015	1-1/2"	Socket	FKM
400128D1A250	3632R-020	2"	Socket	FKM
400128D1A270	3632R-025	2-1/2"	Socket	FKM
400128D1A287	3632R-030	3"	Socket	FKM
400128D1A2C1	3632R-040	4"	Socket	FKM

Spears True Union 2000 CPVC Industrial/Vented Bleach Ball Valves

The True Union 2000 CPVC Industrial/Vented Bleach Ball Valves have a special ball vent design for sodium hypochlorite (bleach) and other chemical applications where entrapped fluids may form caustic crystalline residues and pressure build up from gases developed. Valves have a 1/8" vent hole in ball to equalize internal fluid pressures. Install valve with ball vent on the pressure (upstream) side when in closed position.

FEATURES & BENEFITS

- Rated to 235 psi @ 73° F
- Made in the U.S.A.

CERTIFICATIONS

- ASTM D1784



C&M PART #	MFG PART #	SIZE	CONNECTION	SEAL
400119F4A219	1839V-005C	1/2"	Threaded /Socket	FKM
400119F4A23V	1839V-007C	3/4"	Threaded/Socket	FKM
400119F4A230	1839V-010C	1"	Threaded/Socket	FKM
400119F4A234	1839V-012C	1-1/4"	Threaded/Socket	FKM
400119F4A240	1839V-015C	1-1/2"	Threaded/Socket	FKM
400119F4A250	1839V-020C	2"	Threaded/Socket	FKM
400119D1A270	1832V-025C	2-1/2"	Socket	FKM
400119D1A287	1832V-030C	3"	Socket	FKM
400119D1A2C1	1832V-040C	4"	Socket	FKM

Note: Install valve with ball vent on the pressure (upstream) side when in closed position.

Spears True Union 2000 CPVC Ball Valves

These industrial True Union 2000 CPVC Ball Valves are used for controlling the flow of fluids in piping systems. They are specifically designed for use with chlorinated polyvinyl chloride (CPVC) piping, which is a thermoplastic material known for its chemical resistance and durability.

The true union design of these ball valves allows for easy installation, maintenance, and repair. They feature a union connection that enables the valve to be disassembled from the piping system without the need for cutting or removing the entire pipe. This makes servicing or replacing the valve more convenient and cost-effective.

FEATURES & BENEFITS

- Rated to 235 psi @ 73° F
- 150 psi (2-1/2 to 4") @ 73° F
- Made in the U.S.A.

CERTIFICATIONS

- ASTM D1784



C&M PART #	MFG PART #	SIZE	CONNECTION	SEAL
400074F4A119	1829-005C	1/2"	Threaded/Socket	EPDM
400074F4A13V	1829-007C	3/4"	Threaded/Socket	EPDM
400074F4A130	1829-010C	1"	Threaded/Socket	EPDM
400074F4A134	1829-012C	1-1/4"	Threaded/Socket	EPDM
400074F4A140	1829-015C	1-1/2"	Threaded/Socket	EPDM
400074F4A150	1829-020C	2"	Threaded/Socket	EPDM
400074D1A170	1822-025C	2-1/2"	Socket	EPDM
400074D1A187	1822-030C	3"	Socket	EPDM
400074D1A1C1	1822-040C	4"	Socket	EPDM
400074F4A219	1839-005C	1/2"	Threaded/Socket	FKM
400074F4A23V	1839-007C	3/4"	Threaded/Socket	FKM
400074F4A230	1839-010C	1"	Threaded/Socket	FKM
400074F4A234	1839-012C	1-1/4"	Threaded/Socket	FKM
400074F4A240	1839-015C	1-1/2"	Threaded/Socket	FKM
400074F4A250	1839-020C	2"	Threaded/Socket	FKM
400074D1A270	1832-025C	2-1/2"	Socket	FKM
400074D1A287	1832-030C	3"	Socket	FKM
400074D1A2C1	1832-040C	4"	Socket	FKM
400074F5A119	1821-005CSR	1/2"	SS Reinforced Threaded	EPDM
400074F5A13V	1821-007CSR	3/4"	SS Reinforced Threaded	EPDM
400074F5A130	1821-010CSR	1"	SS Reinforced Threaded	EPDM
400074F5A134	1821-012CSR	1-1/4"	SS Reinforced Threaded	EPDM
400074F5A140	1821-015CSR	1-1/2"	SS Reinforced Threaded	EPDM
400074F5A150	1821-020CSR	2"	SS Reinforced Threaded	EPDM
400074F5A170	1821-025CSR	2-1/2"	SS Reinforced Threaded	EPDM
400074F5A187	1821-030CSR	3"	SS Reinforced Threaded	EPDM
400074F5A1C1	1821-040CSR	4"	SS Reinforced Threaded	EPDM
400074F5A219	1831-005CSR	1/2"	SS Reinforced Threaded	FKM
400074F5A23V	1831-007CSR	3/4"	SS Reinforced Threaded	FKM
400074F5A230	1831-010CSR	1"	SS Reinforced Threaded	FKM
400074F5A234	1831-012CSR	1-1/4"	SS Reinforced Threaded	FKM
400074F5A240	1831-015CSR	1-1/2"	SS Reinforced Threaded	FKM
400074F5A250	1831-020CSR	2"	SS Reinforced Threaded	FKM
400074F5A270	1831-025CSR	2-1/2"	SS Reinforced Threaded	FKM
400074F5A287	1831-030CSR	3"	SS Reinforced Threaded	FKM
400074F5A2C1	1831-040CSR	4"	SS Reinforced Threaded	FKM

Spears True Union 2000 CPVC Retrofit Other Brands Ball Valves

The True Union Retrofit design allows for easy installation and replacement of ball valves without the need for extensive modifications to the piping system. Retrofit valve consists of standard true union 2000 CPVC ball valve plus factory installed extended-socket end connectors. It is specifically designed to fit and adapt to the dimensions and connections of other ball valve brands, making it a convenient solution for upgrading or replacing valves in existing installations. Simply cut out old valve to specified dimensions and install retrofit valve end connectors.

FEATURES & BENEFITS

- Rated to 235 psi (1/2 to 2") @ 73° F
- Made in the U.S.A.

CERTIFICATIONS

- ASTM D1784



C&M PART #	MFG PART #	SIZE	CONNECTION	SEAL
400146D1A119	3622R-005C	1/2"	Socket	EPDM
400146D1A13V	3622R-007C	3/4"	Socket	EPDM
400146D1A130	3622R-010C	1"	Socket	EPDM
400146D1A134	3622R-012C	1-1/4"	Socket	EPDM
400146D1A140	3622R-015C	1-1/2"	Socket	EPDM
400146D1A150	3622R-020C	2"	Socket	EPDM
400146D1A170	3622R-025C	2-1/2"	Socket	EPDM
400146D1A187	3622R-030C	3"	Socket	EPDM
400146D1A1C1	3622R-040C	4"	Socket	EPDM
400146D1A219	3632R-005C	1/2"	Socket	FKM
400146D1A23V	3632R-007C	3/4"	Socket	FKM
400146D1A230	3632R-010C	1"	Socket	FKM
400146D1A234	3632R-012C	1-1/4"	Socket	FKM
400146D1A240	3632R-015C	1-1/2"	Socket	FKM
400146D1A250	3632R-020C	2"	Socket	FKM
400146D1A270	3632R-025C	2-1/2"	Socket	FKM
400146D1A287	3632R-030C	3"	Socket	FKM
400146D1A2C1	3632R-040C	4"	Socket	FKM



Helpful Tip: PVC vs CPVC

Chlorination: CPVC has higher corrosion resistance and is more compatible with sodium hypochlorite, ferric chloride and sodium hydroxide.

Pressure Ratings: CPVC generally has higher pressure ratings compared to PVC.

Applications: PVC is often used for cold water distribution systems, irrigation, and drainage. CPVC, with its higher temperature resistance, is commonly used for hot water systems, including residential hot water lines and industrial applications.

Lansdale Valve Flanged Swing Check Valves

Lansdale Swing Check valves prevent the backflow of water within a piping system. For a check valve to properly function there should be a differential pressure of at least 1/2 psi, this will prevent water hammer and chatter. These check valves may be installed horizontally and if the flow is in an upwards direction, vertically. Valves must be provided with adequate support. Adjoining pipework must be supported to avoid the imposition of pipeline strains on the valve body. Heavy valves may need independent support or anchorage.

FEATURES & BENEFITS

- AWWA C508 standard
- Max working pressure: 350 PSI
- Temperature range: 33° F to 170° F
- UL/ULC Listed and FM Approved
- Removable inspection cover
- Corrosion resistant epoxy coating
- Flanged to ANSI B16.10 Class 125 or ASME B16.42 Class 150 FF



SPECIFICATIONS

PART	MATERIAL	ASTM SPECIFICATION
Body	Ductile Iron	A536 Grade 65-45-12
Body Seat	Bronze	B62 C83600
Disc	Ductile Iron with EPDM Encapsulated	
Connecting Stem	Stainless Steel	A276 Type 316
Locking Nut	Stainless-Steel	A276 Type 304
Washer	Stainless Steel	A276 Type 304
Bushing	Stainless Steel	A276 Type 304
Hinge: 2" - 6" 8" - 16"	Stainless Steel Ductile Iron	A351 Grade CF8 A536 Grade 65-45-12
Gasket	Rubber	D2000 EPDM
Bonnet	Ductile Iron	A536 Grade 65-45-12
Hinge Pin	Stainless Steel	A276 Type 304
Shaft Bushing	Bronze	B62 C95200
O-Ring	Rubber	D2000 NBR
Locating Sleeve	Stainless Steel	A276 Type 304
Washer	Red Copper	N/A
Plug	Stainless Steel	A276 Type 304
Screw	Carbon Steel	A307 Class B

C&M PART #	MFG PART #	SIZE
1125742C	700-225-01066	2"
1125742E	700-225-01067	3"
1125742F	700-225-01068	4"
1125742G	700-225-01070	6"
11257469	700-225-01071	8"
11257471	700-225-01072	10"
11257472	700-225-01073	12"

Lansdale Valve Swing Check Valves with Lever & Weight

Lansdale ductile iron lever and weight swing check valve is a specific type of check valve designed to control the flow of fluids in a pipeline. The lever and weight mechanism are a specific design feature used in swing check valves. It consists of a lever attached to the valve disc and a weight on the opposite end. The weight helps the valve close quickly when there is a reversal of flow, preventing backflow. The valve may be installed vertically or horizontally for vertical installations, flow must be in upward direction.



FEATURES & BENEFITS

- Resilient seated (EPDM rubber face on the ductile iron disc)
- Bronze seat ring
- "Full Waterway" design per AWWA C508 Standard
- Fusion bonded epoxy powder coated - certified to NSF/ANSI-61 for use in drinking water systems.
- Fusion bonded epoxy coated Interior and exterior per AWWA C550 Standard.
- Working pressure rating at 200 PSI.
- Flanged ends to ANSI B16.1, Class 125
- Temperature range: 33° F to 170° F

CERTIFICATIONS

- UL, FM approved

SPECIFICATIONS

DESCRIPTION	MATERIAL	DESCRIPTION	MATERIAL
Body	Cast Iron, A126 Class B	Plug	Brass
Body Trim	Bronze, B62 C83600	Spacer	PTFE
Disc Trim	Rubber, EPDM	Bushings	Brass
Disc	Cast Iron, A126 Class B	O-Ring	Rubber, EPDM
Hanger	Ductile Iron, A536, 65-42-12	Stem	Stainless Steel, SS304
Bonnet	Cast Iron, A126 Class B	Stem Nut	Carbon Steel
Disc Spacer	Carbon Steel	Bolts	Carbon Steel
Hanger Bolt	Stainless Steel, SS304	Gasket	Graphite
Hanger Nut	Stainless Steel, SS304	Lever	Carbon Steel
Cotter Pin	Stainless Steel, SS304	Weight	ASTM A126 Class B

C&M PART #	MFG PART #	SIZE	LENGTH	HEIGHT
1125752E	700-225-02400	3"	9.5"	5.5"
1125752F	700-225-02405	4"	11.5"	6.6"
1125752G	700-225-02410	6"	14"	8.46"
11257569	700-225-02415	8"	19.5"	10.5"
11257571	700-225-02420	10"	24.5"	12"
11257572	700-225-02425	12"	27.52"	13.5"

Lansdale Valve Wafer Check Valves

Lansdale Wafer check valves have a compact design, making them easy to install between flanges. They typically consist of a thin disc or flap that opens to allow flow in one direction and closes to prevent backflow.



FEATURES & BENEFITS

- The extremely short face to face dimension and compact design of this valve allows installation and service in tight spaces
- Spring assisted for better dynamic behavior
- Soft seated for perfect tightness even at low differential pressure
- Can be installed vertically or horizontally
- Flanges to ANSI B16.1 CLASS 125
- Working pressure 300 PSI
- Working temperature -10°C to 82°C
- Spray-painted or fusion bonded epoxy coated interior and exterior to AWWA C550 standard for corrosion protection

CERTIFICATIONS

- UL Listed/FM Approved

Note: Not intended for use with potable water.

SPECIFICATIONS

PART	MATERIAL	ASTM SPECIFICATION
Body	Ductile Iron	A536 Class 65-45-12
Body Seat Ring	Bronze	B62 C83600
Seat O-Ring	Rubber	D2000 NBR
Disc	Bronze	C83600
Spring	Stainless-Steel	A276 Grade 302
Set Screw	Stainless Steel	A276 Grade 304
Hinge Pin	Stainless Steel	A276 Grade 304
Pin Retainer	Carbon Steel	A105

C&M PART #	MFG PART #	SIZE	LENGTH	DEPTH	OUTLET	INLET
1125822F*	700-225-00860	4"	4.25"	6.75"	4.88"	4.96"
1125822G	700-225-00880	6"	3.75"	8.50"	6.66"	6.14"
11258269	700-225-00900	8"	3.75"	11.0"	8.60"	7.70"

*4" size is provided with 1/2" pipe plug in drain port as standard configuration



Helpful Tip: Valve Maintenance

Valve maintenance is a crucial aspect of ensuring the proper functioning and longevity of valves in various systems, including industrial processes, plumbing, and fluid control applications. Regular maintenance helps prevent issues contributing to the overall reliability and safety of the systems.

- Visual Inspection
- Operational Testing
- Lubrication
- Tightening and Torque Checks
- Packing Inspection and Replacement
- Seal Inspection
- Cleaning
- Corrosion Protection
- Maintenance Documentation

Valve maintenance practices may vary based on the type of valve, its application, and the operating conditions. Adhering to a proactive maintenance schedule helps prevent unexpected failures and ensures the continued reliability of valves in various systems.

Lansdale Valve Lever & Weight Check Valve Spring Kits

Replacement springs for Lever & Weight Valves.

C&M PART #	MFG PART #	SIZE
112576	700-225-02500	3"
112577	700-225-02505	4"
112578	700-225-02510	6"
112579	700-225-02515	8"
112580	700-225-02520	10"
112581	700-225-02525	12"



Lansdale Valve Wafer Check Valve Hardware Kits

Replacement nuts and bolts for Wafer Check Valves.

C&M PART #	MFG PART #	SIZE
112583	700-225-01150	4"
112584	700-225-01160	6"



Lansdale Valve NRS Resilient Ductile Iron Gate Valves

Use the Gate Valves for fully open or closed service in water and sewage disposal applications. Optional test plug on valve body available as special order.



FEATURES & BENEFITS

- Valves comply with AWWA C515-15 standard
- Mechanical joint ends to AWWA C153/A21.53 standard
- Flanged ends to ANSI B16.1, Class 125
- Fusion bonded epoxy coated interior and exterior to AWWA C550 standards
- Temperature range of 33 to 170°F
- Triple O-ring seal prevents leakage
- Open left (open right available upon request)
- NRS (Non-Rising Stem), resilient seated (EPDM encapsulated wedge)

CERTIFICATIONS

- UL Listed/FM Approved, NSF-61/NSF-372

C&M PART #	MFG PART #	SIZE	OAL	NO. OF BOLTS	WEIGHT (lbs)
FLG X FLG GATE VALVES WITH HANDWHEEL					
1125852E	700-275-02000	3"	8"	4	41
1125852F	700-275-02005	4"	9"	8	64
1125852G	700-275-02010	6"	10-1/2"	8	103
11258569	700-275-02015	8"	11-1/2"	8	161
11258571	700-275-02020	10"	13"	12	235
11258572	700-275-02025	12"	14"	12	339
FLG X FLG GATE VALVES WITH 2" OP NUT					
1125862E	700-275-00360	3"	8"	4	41
1125862F	700-275-00365	4"	9"	8	64
1125862G	700-275-00370	6"	10-1/2"	8	103
11258669	700-275-00375	8"	11-1/2"	8	161
11258671	700-275-00380	10"	13"	12	235
11258672	700-275-00385	12"	14"	12	339
MJ X MJ GATE VALVES WITH HANDWHEEL					
1125882E	700-275-02035	3"	9-1/2"	4	45
1125882F	700-275-02040	4"	10"	8	71
1125882G	700-275-02045	6"	11-1/2"	8	116
11258869	700-275-02050	8"	12-1/2"	8	176
11258871	700-275-02055	10"	14-3/4"	12	280
11258872	700-275-02060	12"	14-7/8"	12	386
MJ X MJ GATE VALVES WITH 2" OP NUT					
1125892E	700-275-00460	3"	9-1/2"	4	45
1125892F	700-275-00480	4"	10"	8	71
1125892G	700-275-00500	6"	11-1/2"	8	116
11258969	700-275-00520	8"	12-1/2"	8	176
11258971	700-275-00540	10"	14-3/4"	12	280
11258972	700-275-00560	12"	14-7/8"	12	386
MJ X FLG GATE VALVES WITH 2" OP NUT					
1125912F	700-275-00800	4"	9-1/2"	8	N/A
1125912G	700-275-00810	6"	11"	8	N/A
11259169	700-275-00820	8"	12"	8	N/A
11259171	700-275-00830	10"	13-7/8"	12	N/A
11259172	700-275-00840	12"	14-1/2"	12	N/A

Lansdale Valve Post Indicator Gate Valves

Post Indicator Gate Valves are ideal for fully open or closed service in water and sewage disposal applications. Valves are provided with a universal "Indicator Post Plate." Optional test plug on valve body available as special order.



FEATURES & BENEFITS

- Valves comply with AWWA C515-15 Standard
- Mechanical joint ends to AWWA C153/A21.53 standard
- Flanged ends to ANSI B16.1, Class 125
- Fusion bonded epoxy coated interior and exterior to AWWA C550 standards
- Temperature range of 42 to 180°F
- Non-rising stem, resilient seated (EDPM encapsulated wedge)
- Triple O-ring seal prevents leakage

CERTIFICATIONS

- UL Listed/FM Approved, NSF-61/NSF-372

C&M PART #	MFG PART #	SIZE	OAL	NO. OF BOLTS	WEIGHT (lbs)
FLG X FLG POST INDICATOR GATE VALVES, 2" OP NUT					
1125962F	700-275-00020	4"	9"	8	64
1125962G	700-275-00040	6"	10-1/2"	8	103
11259669	700-275-00060	8"	11-1/2"	8	161
11259671	700-275-00065	10"	13"	12	235
11259672	700-275-00070	12"	14"	12	339
MJ X MJ POST INDICATOR GATE VALVES, 2" OP NUT					
1125972F	700-275-00100	4"	10"	8	71
1125972G	700-275-00120	6"	11-1/2"	8	116
11259769	700-275-00140	8"	12-1/2"	8	176
11259771	700-275-00145	10"	14-3/4"	12	280
11259772	700-275-00150	12"	14-7/8"	12	386

Adjustable Vertical Indicator Posts make identifying the operating state of a buried valve easy. Featuring a telescoping operating rod, adjustable indicator posts can be used for a range of bury depths. Field changes such as adjusting the OPEN and SHUT signs or adjusting the telescoping rod and pipe to the desired depth can be easily performed by removing and then reattaching post to the post flange on the valve.

FEATURES & BENEFITS

- Meet or exceed the requirements of NFPA 24 standard
- Indicates the state of the valve OPEN or SHUT position
- Target nut to allow 13 to 45 turns
- "L" shaped wrench handle fitted with a secure padlock (provided by user)

CERTIFICATIONS

- UL/ULC 789 Listed and FM1110 Approved



C&M PART #	MFG PART #	DESCRIPTION
112592	700-275-00180	18.25 to 60.5" Bury Depth Range
112593	700-275-00185	57 to 81.5" Bury Depth Range
112594	700-275-00190	78 to 102.5" Bury Depth Range
112595	700-275-00195	99 to 123.5" Bury Depth Range



NEED MORE?

Grab a FREE Lab and Field Catalog!

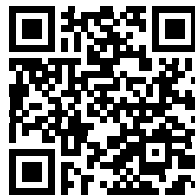

Scan the QR code with your phone to get additional catalogs with even more products from the brands you trust!

Core & Main Supply's Lab & Field Essentials catalogs pack more of the high-quality products you need, along with resources and tips throughout. Keep everything your operation needs in the lab, plant, and field right at your fingertips, 24/7!

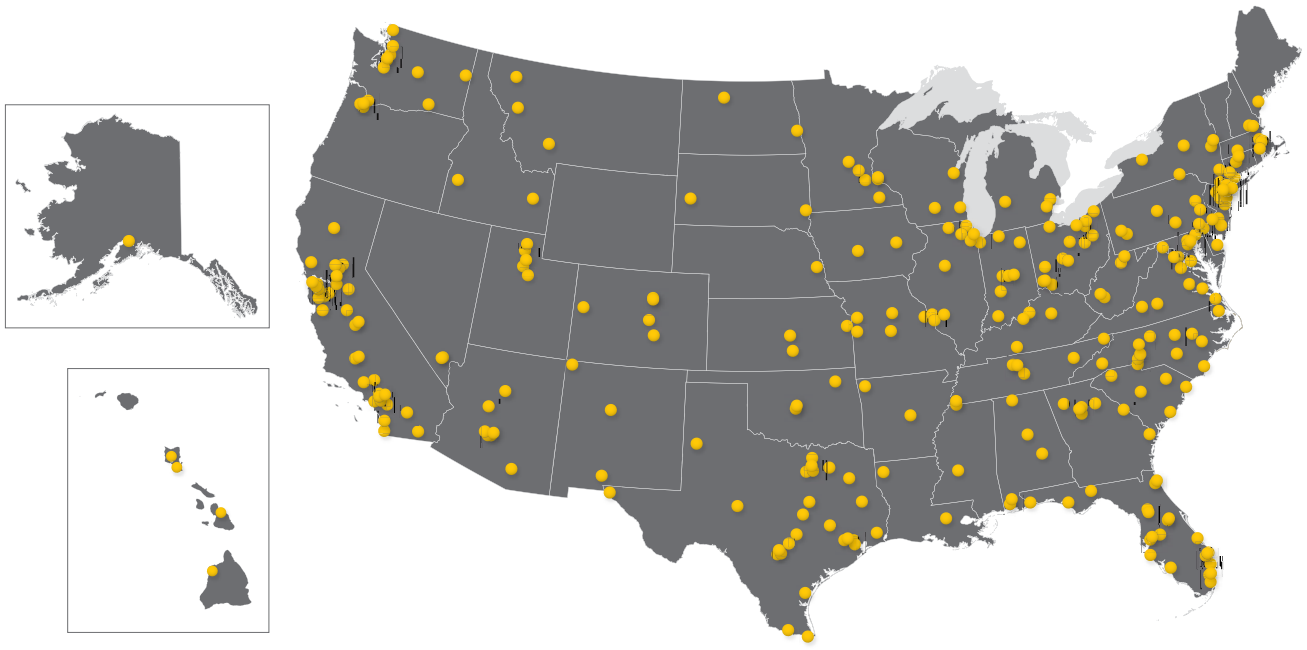

Local Knowledge
Local Experience
Local Service, Nationwide®

Every day, across the nation, our local branches demonstrate our commitment to water and wastewater professionals. Count on Core & Main to provide a quality product assortment from trusted brands, access to industry and product experts, and best-in-class service. **We're in your corner and around the corner.**

A Leading Specialized Distributor of Water, Wastewater and Storm Drainage Products, and Related Services



supply.coreandmain.com



24/7 AVAILABILITY



SHOP ON THE JOB

with our mobile optimized website



SHOP ONLINE

at supply.coreandmain.com



SHOP BY PHONE

at 1-888-885-2673



EXPEDITED DELIVERY AVAILABLE ON MOST ORDERS

With most in-stock items available to ship the same day, you'll get the products you need, right when you need them.



FIRST CLASS SERVICE & RESOURCES

Our product knowledge specialists are available 6 a.m. to 7 p.m. CST to answer any questions you may have. Give them a call today at 1-888-885-2673 or email them at support.supply@coreandmain.com.



1-888-885-2673
supply.coreandmain.com